

**GOCE DELCEV UNIVERSITY, SHTIP, NORTH MACEDONIA
FACULTY OF ELECTRICAL ENGINEERING**

ETIMA 2021

FIRST INTERNATIONAL CONFERENCE

19-21 OCTOBER, 2021



**TECHNICAL SCIENCES APPLIED IN ECONOMY,
EDUCATION AND INDUSTRY**



УНИВЕРЗИТЕТ „ГОЦЕ ДЕЛЧЕВ” - ШТИП
ЕЛЕКТРОТЕХНИЧКИ ФАКУЛТЕТ

UNIVERSITY „GOCE DELCHEV” - SHTIP
FACULTY OF ELECTRICAL ENGINEERING

ПРВА МЕЃУНАРОДНА КОНФЕРЕНЦИЈА
FIRST INTERNATIONAL CONFERENCE

ЕТИМА / ETIMA 2021

ЗБОРНИК НА ТРУДОВИ
CONFERENCE PROCEEDINGS

19-21 Октомври 2021 | 19-21 October 2021

Главен и одговорен уредник / Editor in Chief

Проф.д-р Сашо Гелев

Prof.d-r Saso Gelev

Јазично уредување / Language Editor

Весна Ристова (Македонски) / Vesna Ristova (Macedonian)

Техничко уредување / Technical Editing

Доц.д-р Далибор Серафимовски / d-r Dalibor Serafimovski

Издавач / Publisher

Универзитет „Гоце Делчев“ - Штип / University Goce Delchev - Stip

Електротехнички факултет / Faculty of Electrical Engineering

Адреса на организационен комитет / Adress of the organizational committee

Универзитет „Гоце Делчев“ – Штип / University Goce Delchev - Stip

Електротехнички факултет / Faculty of Electrical Engineering

Адреса: ул. „Крсте Мисирков“ бр. 10-А / Adress: Krste Misirkov, 10 - A

Пош. фах 201, Штип - 2000, С.Македонија / PO BOX 201, Stip 2000, North Macedonia

E-mail: conference-etf@ugd.edu.mk

CIP - Каталогизација во публикација

Национална и универзитетска библиотека "Св. Климент Охридски", Скопје

62-049.8(062)

004-049.8(062)

МЕЃУНАРОДНА конференција ЕТИМА (1 ; 2021)

Зборник на трудови [Електронски извор] / Прва меѓународна

конференција ЕТИМА 2021, 19-21 Октомври 2021 = Conference proceedings /

First international conferece ЕТИМА 2021, 19-21 October 2021 ; [главен и

одговорен уредник Сашо Гелев]. - Штип: Универзитет "Гоце Делчев",

Електротехнички факултет = Shtip: University "Goce Delchev", Faculty of

Electrical Engineering, 2021

Начин на пристапување (URL): <https://js.ugd.edu.mk/index.php/etima>. -

Текст во PDF формат, содржи 358 стр.илустр. - Наслов преземен од

екранот. - Опис на изворот на ден 15.10.2021. - Трудови на мак. и англ.

јазик. - Библиографија кон трудовите

ISBN 978-608-244-823-7

1. Напор. ств. насл.

а) Електротехника -- Примена -- Собири б) Машинство -- Примена -- Собири

в) Автоматика -- Примена -- Собири г) Информатика -- Примена -- Собири

COBISS.MK-ID 55209989



Прва меѓународна конференција ЕТИМА
19-21 Октомври 2021
First International Conference ETIMA
19-21 October 2021

**ОРГАНИЗАЦИОНЕН ОДБОР
ORGANIZING COMMITTEE**

Василија Шарац / Vasilija Sarac

Електротехнички факултет,
Универзитет „Гоце Делчев“ - Штип, Северна Македонија
Faculty of Electrical Engineering,
Goce Delchev University - Stip, North Macedonia

Сашо Гелев / Saso Gelev

Електротехнички факултет,
Универзитет „Гоце Делчев“ - Штип, Северна Македонија
Faculty of Electrical Engineering,
Goce Delchev University - Stip, North Macedonia

Тодор Чекеровски / Todor Cekеровски

Електротехнички факултет,
Универзитет „Гоце Делчев“ - Штип, Северна Македонија
Faculty of Electrical Engineering,
Goce Delchev University - Stip, North Macedonia

Далибор Серафимовски / Dalibor Serafimovski

Електротехнички факултет,
Универзитет „Гоце Делчев“ - Штип, Северна Македонија
Faculty of Electrical Engineering,
Goce Delchev University - Stip, North Macedonia

Маја Кукушева Панева / Maja Kukuseva Paneva

Електротехнички факултет,
Универзитет „Гоце Делчев“ - Штип, Северна Македонија
Faculty of Electrical Engineering,
Goce Delchev University - Stip, North Macedonia

Билјана Читкушева Димитровска / Biljana Citkuseva Dimitrovska

Електротехнички факултет,
Универзитет „Гоце Делчев“ - Штип, Северна Македонија
Faculty of Electrical Engineering,
Goce Delchev University - Stip, North Macedonia

Весна Конзулова / Vesna Konzulova

Електротехнички факултет,
Универзитет „Гоце Делчев“ - Штип, Северна Македонија
Faculty of Electrical Engineering,
Goce Delchev University - Stip, North Macedonia



Прва меѓународна конференција ЕТИМА
19-21 Октомври 2021
First International Conference ETIMA
19-21 October 2021

**ПРОГРАМСКИ И НАУЧЕН ОДБОР
SCIENTIFIC COMMITTEE**

Со Ногучи / So Noguchi

Висока школа за информатички науки и технологии
Универзитет Хокаидо, Јапонија
Graduate School of Information Science and Technology
Hokkaido University, Japan

Диониз Гашпаровски / Dionýz Gašparovský

Факултет за електротехника и информатички технологии,
Словачки Технички Универзитет во Братислава, Словачка
Faculty of Electrical Engineering and Information Technology
Slovak Technical University in Bratislava, Slovakia

Антон Белан / Anton Belán

Факултет за електротехника и информатички технологии
Словачки Технички Универзитет во Братислава, Словачка
Faculty of Electrical Engineering and Information Technology
Slovak Technical University in Bratislava, Slovakia

Георги Иванов Георгиев / Georgi Ivanov Georgiev,

Технички Универзитет во Габрово, Бугарија
Technical University in Gabrovo, Bulgaria

Ивелина Стефанова Балабанова / Ivelina Stefanova Balabanova,

Технички Универзитет во Габрово, Бугарија
Technical University in Gabrovo, Bulgaria

Бојан Димитров Карапeneв / Boyan Dimitrov Karapenev

Технички Универзитет во Габрово, Бугарија
Technical University in Gabrovo, Bulgaria

Сашо Гелев / Saso Gelev

Електротехнички факултет,
Универзитет „Гоце Делчев“ - Штип, Северна Македонија
Faculty of Electrical Engineering,
Goce Delchev University - Stip, North Macedonia

Влатко Чингоски / Vlatko Cingoski
Електротехнички факултет,
Универзитет „Гоце Делчев” - Штип, Северна Македонија
Faculty of Electrical Engineering,
Goce Delchev University - Stip, North Macedonia

Божо Крстајиќ / Bozo Krstajic
Електротехнички факултет
Универзитет во Црна Гора, Црна Гора
Faculty of Electrical Engineering,
University in Montenegro, Montenegro

Милован Радуловиќ / Milovan Radulovic
Електротехнички факултет
Универзитет во Црна Гора, Црна Гора
Faculty of Electrical Engineering,
University in Montenegro, Montenegro

Гоце Стефанов / Goce Stefanov
Електротехнички факултет,
Универзитет „Гоце Делчев” - Штип, Северна Македонија
Faculty of Electrical Engineering,
Goce Delchev University - Stip, North Macedonia

Мирјана Периќ / Mirjana Peric
Електронски факултет
Универзитет во Ниш, Србија
Faculty of Electronic Engineering,
University of Nis, Serbia

Ана Вучковиќ / Ana Vuckovic
Електронски факултет
Универзитет во Ниш, Србија
Faculty of Electronic Engineering,
University of Nis, Serbia

Тодор Чекеровски / Todor Cekеровски
Електротехнички факултет,
Универзитет „Гоце Делчев” - Штип, Северна Македонија
Faculty of Electrical Engineering,
Goce Delchev University - Stip, North Macedonia

Далибор Серафимовски / Dalibor Serafimovski
Електротехнички факултет,
Универзитет „Гоце Делчев” - Штип, Северна Македонија
Faculty of Electrical Engineering,
Goce Delchev University - Stip, North Macedonia

Мирослава Фаркаш Смиткова / Miroslava Farkas Smitková

Факултет за електротехника и информациони технологии
Словачки Технички Универзитет во Братислава, Словачка
Faculty of Electrical Engineering and Information Technology
Slovak Technical University in Bratislava, Slovakia

Петер Јанига / Peter Janiga

Факултет за електротехника и информациони технологии
Словачки Технички Универзитет во Братислава, Словачка
Faculty of Electrical Engineering and Information Technology
Slovak Technical University in Bratislava, Slovakia

Јана Радичова / Jana Raditschová,

Факултет за електротехника и информациони технологии
Словачки Технички Универзитет во Братислава, Словачка
Faculty of Electrical Engineering and Information Technology
Slovak Technical University in Bratislava, Slovakia

Драган Миновски / Dragan Minovski

Електротехнички факултет,
Универзитет „Гоце Делчев” - Штип, Северна Македонија
Faculty of Electrical Engineering,
Goce Delchev University - Stip, North Macedonia

Василија Шарац / Vasilija Sarac

Електротехнички факултет,
Универзитет „Гоце Делчев” - Штип, Северна Македонија
Faculty of Electrical Engineering,
Goce Delchev University - Stip, North Macedonia

Александар Туцаров / Aleksandar Tudzarov

Електротехнички факултет,
Универзитет „Гоце Делчев” - Штип, Северна Македонија
Faculty of Electrical Engineering,
Goce Delchev University - Stip, North Macedonia

Владимир Талевски / Vladimir Talevski

Електротехнички факултет,
Универзитет „Гоце Делчев” - Штип, Северна Македонија
Faculty of Electrical Engineering,
Goce Delchev University - Stip, North Macedonia



Прва меѓународна конференција ЕТИМА First International Conference ETIMA

PREFACE

The Faculty of Electrical Engineering at University Goce Delcev (UGD), has organized the International Conference *Electrical Engineering, Informatics, Machinery and Automation - Technical Sciences applied in Economy, Education and Industry-ETIMA*.

ETIMA has a goal to gather the scientists, professors, experts and professionals from the field of technical sciences in one place as a forum for exchange of ideas, to strengthen the multidisciplinary research and cooperation and to promote the achievements of technology and its impact on every aspect of living. We hope that this conference will continue to be a venue for presenting the latest research results and developments on the field of technology.

Conference ETIMA was held as online conference where contributed more than sixty colleagues, from six different countries with forty papers.

We would like to express our gratitude to all the colleagues, who contributed to the success of ETIMA'21 by presenting the results of their current research activities and by launching the new ideas through many fruitful discussions.

We invite you and your colleagues also to attend ETIMA Conference in the future. One should believe that next time we will have opportunity to meet each other and exchange ideas, scientific knowledge and useful information in direct contact, as well as to enjoy the social events together.

The Organizing Committee of the Conference

ПРЕДГОВОР

Меѓународната конференција *Електротехника, Технологија, Информатика, Машинство и Автоматика-технички науки во служба на економија, образование и индустрија-ЕТИМА* е организирана од страна на Електротехничкиот факултет при Универзитетот Гоце Делчев.

ЕТИМА има за цел да ги собере на едно место научниците, професорите, експертите и професионалците од полето на техничките науки и да представува форум за размена на идеи, да го зајканува мултидисциплинарното истражување и соработка и да ги промовира технолошките достигнувања и нивното влијание врз секој аспект од живеењето. Се надеваме дека оваа конференција ќе продолжи да биде настан на кој ќе се презентираат најновите резултати од истражувањата и развојот на полето на технологијата.

Конференцијата ЕТИМА се одржа online и на неа дадоа свој допринос повеќе од шеесет автори од шест различни земји со четириесет труда.

Сакаме да ја искажеме нашата благодарност до сите колеги кои допринесоа за успехот на ЕТИМА'21 со презентирање на резултати од нивните тековни истражувања и со лансирање на нови идеи преку многу плодни дискусии.

Ве покануваме Вие и Вашите колеги да земете учество на ЕТИМА и во иднина. Веруваме дека следниот пат ќе имаме можност да се сретнеме, да размениме идеи, знаење и корисни информации во директен контакт, но исто така да уживаме заедно и во друштвените настани.

Организационен одбор на конференцијата

Содржина / Table of Contents

ASSESSING DIGITAL SKILLS AND COMPETENCIES OF PUBLIC ADMINISTRATION AND DEFINING THEIR PROFICIENCY LEVEL.....	12
PWM OPERATION OF SYNCHRONOUS PERMANENT MAGNET MOTOR.....	21
SPEED REGULATION OF INDUCTION MOTOR WITH PWM INVERTER.....	30
WI-FI SMART POWER METER	42
RF SENSOR SMART NETWORK.....	50
FREQUENCY SINUS SOURCE.....	62
MEASUREMENT ON COMPENSATION CAPACITANCE IN INDUCTIVE NETWORK BY MICROCONTROLLER	70
ИЗРАБОТКА НА ВЕШТ НАОД И МИСЛЕЊЕ ОД ОБЛАСТА НА ЕЛЕКТРОТЕХНИЧКИТЕ НАУКИ.....	79
SIMULATION OF AN INDUSTRIAL ROBOT WITH THE HELP OF THE MATLAB SOFTWARE PACKAGE.....	86
BATTERY ENERGY STORAGE SYSTEMS AND TECHNOLOGIES:A REVIEW ..	95
POWER-TO-X TECHNOLOGIES.....	105
NEW INNOVATIVE TOURISM PRODUCT FOR REANIMATING RURAL AREAS	115
PROPOSED MODEL FOR BETTER ENGLISH LANGUAGE ACQUISITION, BASED ON WEARABLE DEVICES.....	123
OPEN SOURCE LEARNING PLATFORM – MOODLE	132
СПОРЕДБЕНА ТЕХНО-ЕКОНОМСКА АНАЛИЗА ПОМЕЃУ ТЕРМИЧКИ ИЗОЛИРАН И ТЕРМИЧКИ НЕИЗОЛИРАН СТАНБЕН ОБЈЕКТ	139
COMPARISON OF PERT AND MONTE CARLO SIMULATION	149
E-LEARNING – CYBER SECURITY CHALLENGES AND PROTECTION MECHANISMS	156
SECURITY AND PRIVACY WITH E-LEARNING SOFTWARE.....	164
ROOTKITS – CYBER SECURITY CHALLENGES AND MECHANISMS FOR PROTECTION	174
TOOLS AND TECHNIQUES FOR MITIGATION AND PROTECTION AGAINST SQL INJECTION ATTACKS	182
INFLUENCE OF ROTATION ANGLE OF LUMINAIRES WITH ASYMMETRICAL LUMINOUS INTENSITY DISTRIBUTION CURVE ON CALCULATED PHOTOMETRIC PARAMETERS.....	189
PHOTOMETRIC PARAMETERS OF LED LUMINAIRES WITH SWITCHABLE CORRELATED COLOUR TEMPERATURE	197
ENERGY-EFFICIENT STREET LIGHTING SYSTEM OF THE CITY OF SHIP USING SOLAR ENERGY AND LED TECHNOLOGY.....	204
NANOTECHNOLOGY–BASED BIOSENSORS IN DRUG DELIVERY SYSTEMS: A REVIEW.....	212

IOT SYSTEM FOR SHORT-CIRCUIT DETECTION OF DC MOTOR AT EKG-15 EXCAVATOR	222
DESIGN OF A PHOTOVOLTAIC POWER PLANT	231
DEVELOPMENT OF COMPUTER SOFTWARE FOR CREATING CHOREOGRAPHY	241
AUTOMATED SYSTEM FOR SMART METER TESTING.....	249
INFLUENCE DIMING OF LED LAMPS TO ELECTRICAL PARAMETERS	255
INRUSH CURRENT OF LAMP.....	261
COMPLEX EVALUATION MODEL OF A SMALL-SCALE PHOTOVOLTAIC INSTALLATION PROFITABILITY	269
IMPACT OF FAULTS IN TRANSMISSION AND DISTRIBUTION NETWORK ON VOLTAGE SAGS	278
ON APPLICABILITY OF BLACK-SCHOLES MODEL TO MSE	290
ACOUSTIC SIGNAL DENOISING BASED ON ROBUST PRINCIPAL COMPONENT ANALYSIS	300
INVESTIGATION OF EFFICIENCY ASPECTS IN 3×3 PHOTOVOLTAIC PLANT USING MODEL OF SHADING	309
PROGRESS OF NO-INSULATION HTS MAGNET DEVELOPMENT TOWARDS ULTRA-HIGH MAGNETIC FIELD GENERATION.....	319
GRID-CONNECTED HYBRID PV SYSTEM WITH BATTERY STORAGE.....	326
INVESTIGATION ON STABILITY OF PANCAKE COILS WOUND WITH BUNDLED MULTIPLE REBCO CONDUCTORS	336
ON-LINE МУЛТИМЕДИСКИ ОБРАЗОВНИ КАРТИЧКИ	343
АЛГОРИТАМОТ „ВЕШТАЧКА КОЛОНИЈА НА ПЧЕЛИ“	352



FREQUENCY SINUS SOURCE

Goce Stefanov¹, Vasilija Sarac²

¹Faculty of Electrical Engineering University Goce Delcev Stip R.Macedonia, goce.stefanov@ugd.edu.mk

²Faculty of Electrical Engineering University Goce Delcev Stip R.Macedonia, vasilija.sarac@ugd.edu.mk

Abstract

In the paper are presented the results of a practically realized on variable frequency sinus source. This source generated sinusoidal voltage with amplitude from 0 to 220 V and frequency from 0 to 100 Hz. The solution is based on EG8010 integrated circuit and driver circuit IR2010s. Control electronics operate IGBT transistors in the topology of full bridge. The operation of the circuit is verified with oscillograms and data obtained from measurements of the practically realized prototype.

Key words

PWM signal, frequency, sinus.

1. Introduction

The electronics converters used to control in power actuators (motors, heating devices) at the output generate voltage and current with a square waveform or waveform which in the first approximation is a modified sine wave. Therefore, there is a harmonic distortion of the output voltages and currents at these power sources. This causes a reduction in the power factor and the efficiency of the source [1]. One of the main tasks of electronics that deals with this issue is the design of electronic components and devices that will provide a sine wave form of the output voltage and current of the power source.

On the other hand electronic devices that control converters that drive induction motors, need to provide a variable frequency waveform. This is in line with the requirement for the induction motors to run at a constant torque, ie the operation of the motor at a constant torque requires the V/f ratio to be constant.

A sinusoidal wave source is also required and for laboratory research.

Development of the electronic components and devices for power source is based on the development of microelectronics circuits [2]. There are mainly two directions of development of integrated circuits that are used in the power electronics. On one side are microcomputers [3], [4], [5], and on the other side are typical integrated circuits designed for special purposes [6], [7]. Microcomputers are intelligent electronic component which have a number of advantages over discrete electronic components. Their main advantage is the packing density of the chip itself. It is the result of the development of microelectronics and enables over one million discrete electronic elements to be embedded on a surface of 1 cm². Their second advantage, which distinguishes them from discrete electronic components, is their application flexibility [3], [4], [5]. The latter implies the ability to run different applications with the same network hardware, and with software changes. But on the other hand, the design of electronic circuits with a microcomputer requires knowledge of appropriate software and in the development of the product converter it is necessary to include more specialists who know the hardware, software and related knowledge to the topologists of the converters.

Unlike from design of the converters based of microcomputer, design based of special circuit requires reduced knowledge of hardware, software, and only a good knowledge of converter topology is enough to make a successful converter product [6], [7]. Clearly, which approach will are choose in the design of the converter depends on its nominal power. But for small and medium power up to 5kW, it can be said that the design of a converter with special circuits is more economically justified.

Therefore in this paper we want to verify the possibility of using an sinus source based on special circuit that, in variable frequency and amplitude conditions, gives optimal results comparable to a normal inverter system, with the difference that this system uses a low-cost microcontroller. Indeed, the purpose is to evaluate the degree of precision that can be achieved by using this integrated solution. Frequent sine source is based on SPWM technique and SPWM signal.

Guided by the main goal of the paper, implementation of the special integrated circuit in generating SPWM (sine pulse wave modulation) signals and realization of the converter with power driver, here will be explained the functioning of these three interconnected parts, ie. SPWM, integrated circuit and power driver.

In the Fig. 1 is shown a block diagram on 1-phase motor which is controlled by special integral circuit.

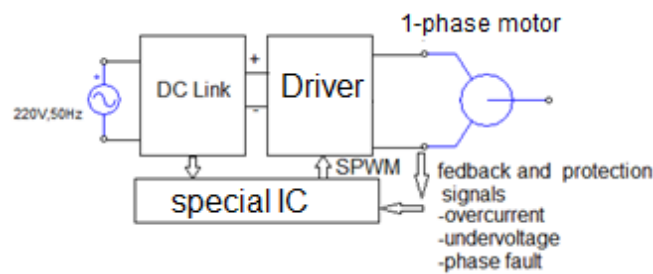

Fig. 1. Block diagram on 3-phase motor controlled by microcontroller.

SPWM signal which is a width modulated signal but with certain values on such a way that we could create a sine shape wave at the output. This with used on MOSFET or IGBT transistors could result in a sine wave inverter.

It is generally known that PWM signal is pulse width modulation. That means we modulate the width of a square signal and by that we could control power. But, this width in case of normal PWM is always the same. In case of SPWM or sinusoidal pulse width modulation, the width of the signal is increasing and decreasing and my that simulating the curve of the sine wave. With small width pulse, the output will increase a little bit and that represents the zone after the 0 cross of the sine wave. Then with bigger widths, the output is getting bigger and bigger and then it starts to get lower, just as a sine wave. Using two transistors switching, can could get both the positive and negative sides of the sine wave, Fig. 2.

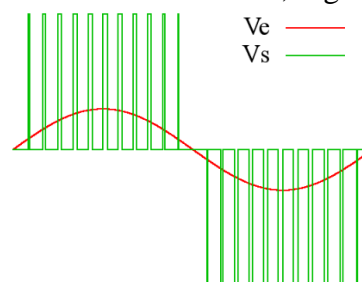

Fig. 2. Construction of SPWM signal.

In the Fig. 3 below can see a bit better how the width of the SPWM can create a good sinusoidal shape at the output. Will use Integral Circuit to generate this SPWM signal. We apply this signal to the power driver. These will be connected to the motor. In the Fig. 3 is shown SPWM signal and the current and voltage waveforms of the motor.

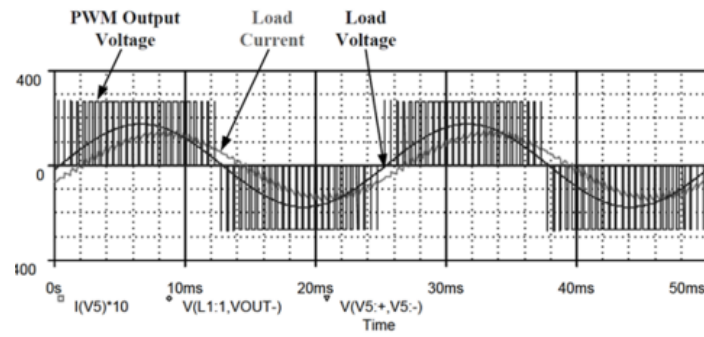

Fig. 3. SPWM signal and the current and voltage waveforms of the motor.

2. Characteristics of the EG 8010 Special Integral Circuit

This Integral Circuit allows to obtain the pure sine wave at 50/60 Hz with high precision and low harmonic distortion. It is also an external 12MHz crystal oscillator that allows you to adjust the system clock. Lastly there is a sinusoidal SPWM generator. We report below the block diagram and the electrical characteristics of the Integral Circuit. In the Fig. 4 is shown block diagram on this circuit. This circuit can operation in unipolar and bipolar mod. With unipolar modulation operation, only one of the two bridges (SPWMOUT3 and SPWMOUT4) will be used for the output modulated in SPWM, the other bridge will be used instead for the fundamental output (SPWMOUT1, SPWMOUT2). From the circuit point of view there will be an inductor and a capacitor, to create an LC filter, connected to the output port of the SPWM and there will also be a voltage feedback circuit connected to the output of the inductor.

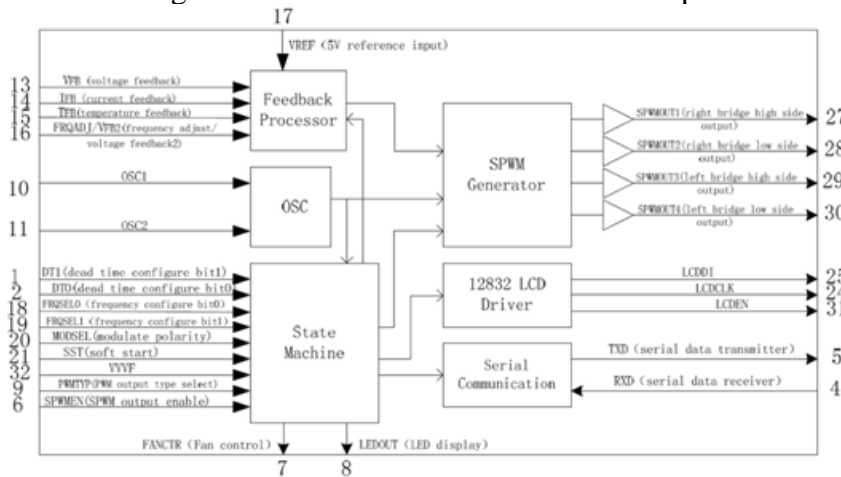

Fig. 4. Block diagram on EG 8010 circuit.

EG 8010 can ensure that the source (converter) operates in mode on variable output voltage and constant frequency, in mode on constant voltage and variable frequency and in mode on variable voltage and variable frequency. The first and second mode is used for AC voltage consumers and the third for AC motor speed regulation. In the Fig.5 is shown the physical appearance of the electronic board EG002 where they are embedded IC EG8010 and driver IRF2110. In the Fig. 6 is shown electrical circuit on the electronic board with build IC EG8010 and driver IRF2110.

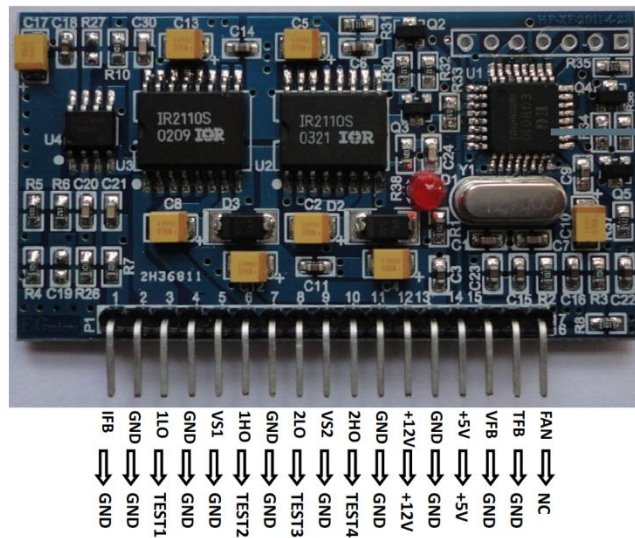

Fig. 5. Electronic board EGS002 with build IC EG8010 and driver IRF2110.

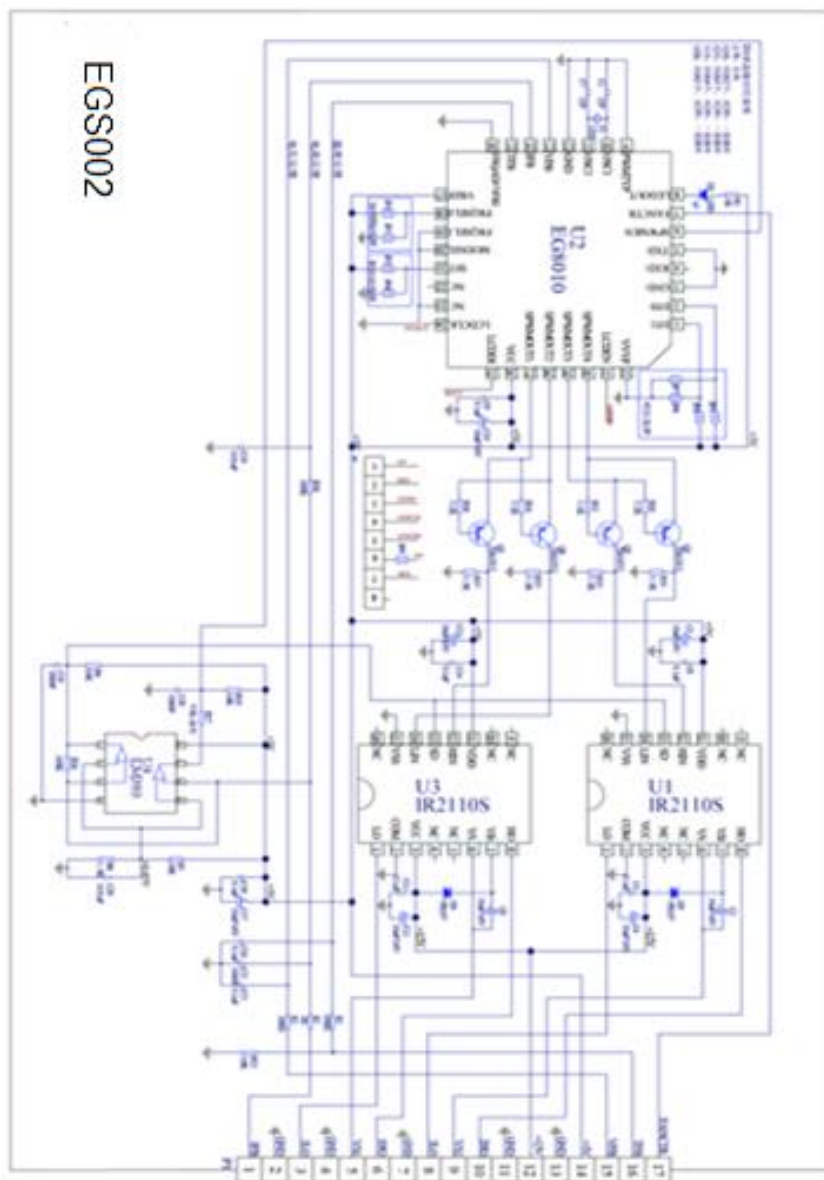

Fig. 6. Electrical circuit on the board EG002 with build IC EG8010 and driver IRF2110.

In this paper, a converter design based on EG 8010 in mode on constant voltage and variable frequency is made. In the Fig. 7 is shown electrical connected circuit where EG8010 operates as a source frequency controller.

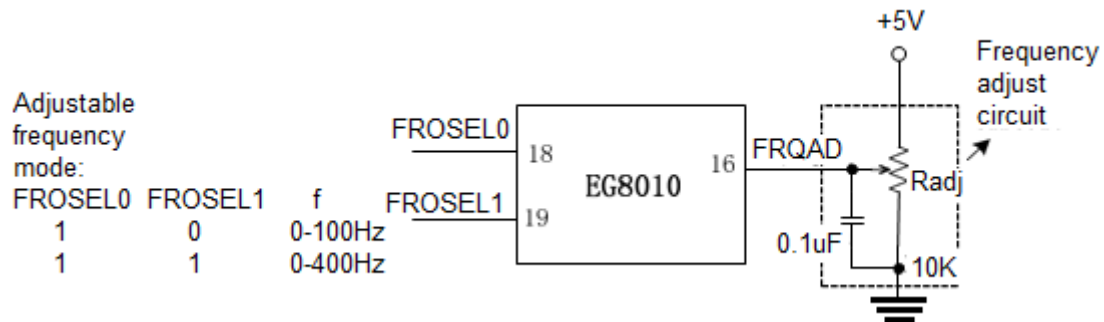

Fig. 7. Electrical connected circuit where EG8010 operates as a source frequency controller.

EG8010 has two frequency modes: constant frequency mode and adjustable frequency mode. In adjustable frequency mode, EG8010 only uses unipolar modulation, and pin (20)MODSEL has to connect to low level. Pins FRQSEL1 and FRQSEL0 set the frequency mode. In constant frequency mode, “00” outputs 50Hz frequency and “01” outputs 60Hz frequency. FRQADJ has no function in constant mode. Pin (16) is used as VFB2 voltage feedback circuit under bipolar modulation. In adjustable frequency mode, “10” outputs frequency in range of 0-100Hz and “11” outputs frequency in range of 0-400Hz. Pin FRQADJ adjusts the frequency as shown in figure 8.6a. Pin FRQADJ’s voltage varies from 0-5V, which is corresponding to the fundamental wave output frequency from 0-100Hz or 0-400Hz. This function accompanies with pin VVVF can be used in the single phase frequency transformer system.

3. Experimental results

The operation of the EG8010 circuit is experimentally illustrated in the mode of constant voltage and variable frequency. For this purpose the corresponding pins of the EG 8010 are set as follows: for source with 100Hz variable frequency pins FRQSEL1,FRQSEL0=10, or for source with 400 Hz variable frequency pins FRQSEL1,FRQSEL0=11, and pin VVVF is setting in logical 0. Variable frequency from 0 to 100 Hz (or 0 to 400 Hz) is setting with resistor connected to pin 16 on EG8010 shown in Fig. 7. AC output voltage is adjusted by the feedback resistor R23.

To illustrate the mode of constant voltage and variable frequency, a prototype of a frequency sine source was designed and practically realized. In the Fig. 8 is shown the prototype in the manufacturing phase and Fig. 8 b is shows the finished device.

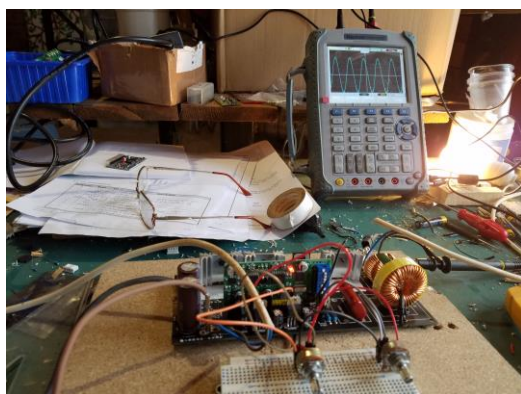

a.)

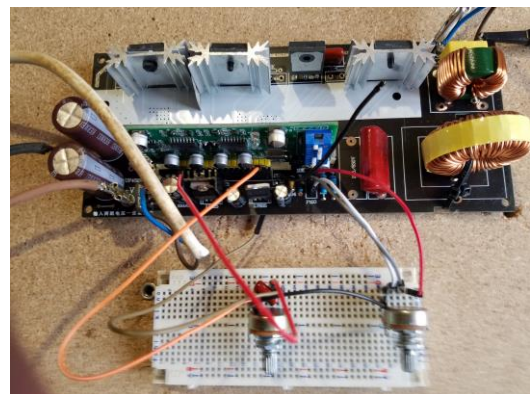

b.)

Fig. 8. Prototype of practically realized a frequency sine source: a.) in the manufacturing phase, b.) finished device.

In the Fig. 10a is shown PWM waveform on the output SPWMOUT3 and SPWMOUT4 on EG 8010.

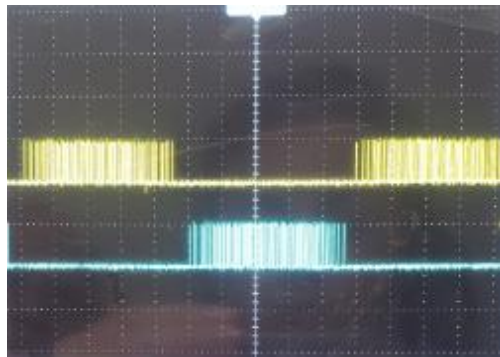
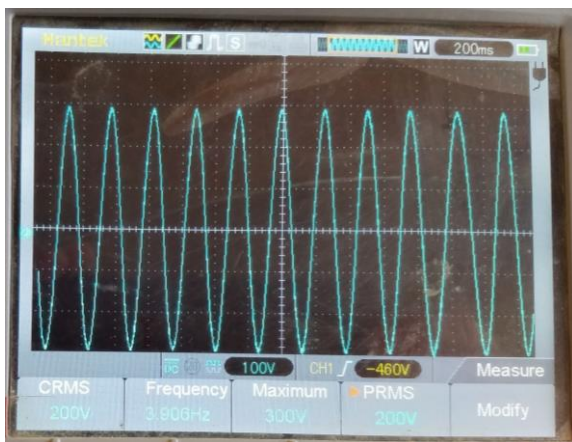

Fig. 10. PWM waveform on the output SPWMOUT3 and SPWMOUT4 horizontal is 4 ms/div and vertical is 5 V/div.

From Fig. 10 are see that the pulse on output SPWMOUT3 and SPWMOUT3 are phase shifted for 180. It provides orthogonal switching of IGBT transistors in one half bridge.

For verification of the work of the realized frequency sine source, are made oscillograms which are shown in the Fig. 9.



a.)

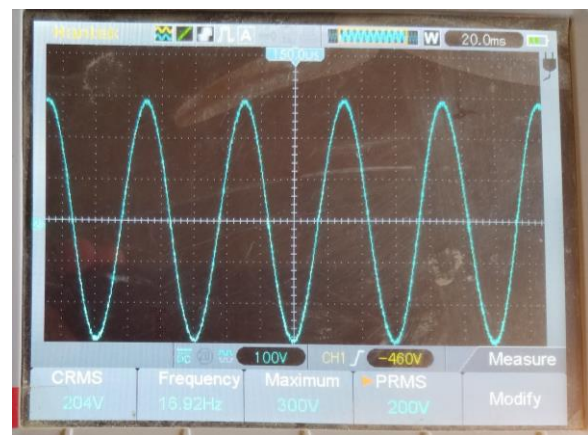

b.)

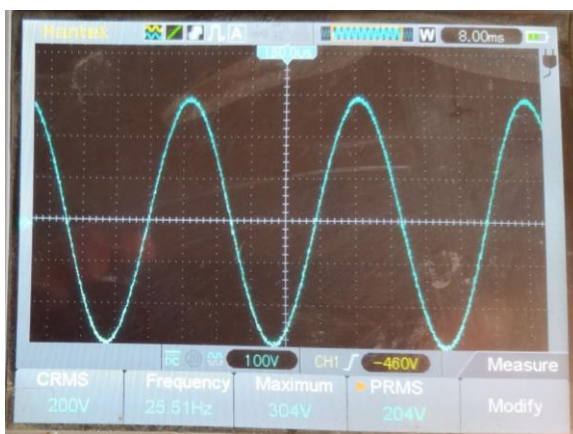

c.)

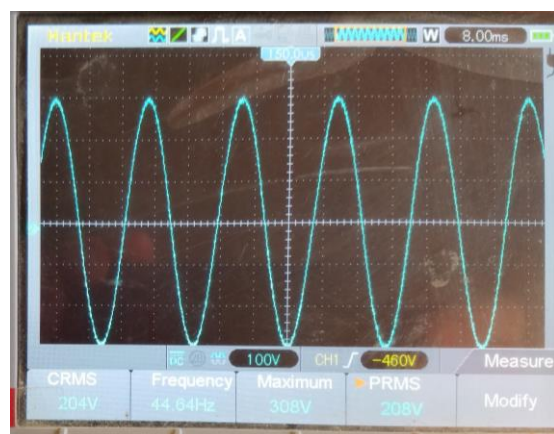

d.)



e.)

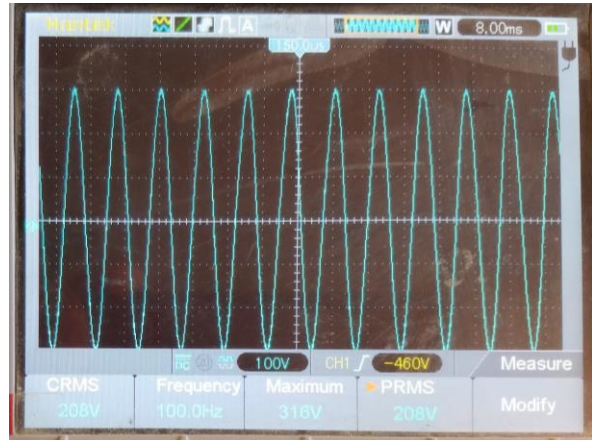

f.)

Fig. 9. Oscillograms from the work of the frequency sine source: a.) 3 Hz, horizontal div is 200 ms, b.) 16 Hz, horizontal div is 20 ms, c.) 25 Hz, horizontal div is 8 ms, d.) 44 Hz, horizontal div is 8 ms, e.) 69 Hz, horizontal div is 8 ms, f.) 100 Hz, horizontal div is 8 ms.

From Fig. 9 it can be seen that all oscillograms have a sine waveform, the vertical base is 100V/div and the sine wave amplitude is 300 V. The oscillograms in Fig. 9 are made when EG8010 works like source with 100Hz variable frequency and pins FRQSEL1,FRQSEL0=10. In the Fig 10 are shown the oscillograms when EG8010 works like source with 400Hz variable frequency and pins FRQSEL1,FRQSEL0=11.



a.)



b.)



c.)

Fig. 10. Oscillograms from the work of the frequency sine source: a.) 135 Hz, horizontal div is 2 ms, b.) 217 Hz, horizontal div is 2 ms, c.) 305 Hz, horizontal div is 2 ms.

Conclusions

The paper analyzes the application of a special integrated circuit which controlling inverter to generate sine voltage. The characteristics of the circuit are given and the advantages of its application in relation to the inverters controlled by microcomputer are emphasized. Designed and experimentally is realized prototype on frequency sine source controlling by this circuit. The results of the work of the prototype confirmed by the oscillograms, show that the realized frequency sine source generates voltage with sine waveform with variable frequency and constant amplitude.

References

- [1] Williams W. B., (2006). Principles and Elements of Power Electronics, University of Strathclyde, Glasgow.
- [2] Kumar A.A., (2014). Pulse and Digital Circuits, PHI.
- [3] Atmel AVR, (2018) 48A/PA/88A/PA/168A/PA/328/P, Microchip Technology Incorporated, All Rights Reserved.
- [4] Atmel ATmega, (2014), 640/V-1280/V-1281/V-2560/V-2561/V, Atmel Corporation, 1600 Technology Drive, San Jose, CA 95110 USA.
- [5] <https://www.theengineeringprojects.com/2018/06/introduction-to-arduino-nano.html>.
- [6] https://www.lz2gl.com/data/power-inverter_3kW/eg8010_datasheet_en.
- [7] https://www.egmicro.com/download/EGS002_manual