

INTERNATIONAL SCIENTIFIC JOURNAL

trans & MOTAUTO WORLD

YEAR II, ISSUE 6/2017

ISSN PRINT 2367-8399

ISSN WEB 2534-8493



SCIENTIFIC TECHNICAL UNION OF MECHANICAL ENGINEERING "INDUSTRY 4.0"
108 BAKOVSKI STR., SOFIA 1000, BULGARIA

PUBLISHER:

**SCIENTIFIC TECHNICAL UNION OF MECHANICAL ENGINEERING
INDUSTRY-4.0**

108, Rakovski Str., 1000 Sofia, Bulgaria

tel. (+359 2) 987 72 90,

tel./fax (+359 2) 986 22 40,

office@stumejournals.com

www.stumejournals.com

ISSN PRINT 2367-8399

ISSN WEB 2534-8493

YEAR II, ISSUE 6 / 2017

EDITORIAL BOARD

CHIEF EDITOR

Prof. Petar Kolev, Bulgaria

RESPONSIBLE SECRETARY:

Prof. Nikolay Tonchev, Bulgaria

MEMBERS:

Prof. Ahmet H. Ertas, TR

Prof. Aleksandar Kostikj, MK

Prof. Andrey Ferenets, RU

Prof. Angel Dimitrov, BG

Prof. Beti Angelevska, MK

Prof. Daimis Berjoza, LV

Prof. Dan Scarpete, RO

Prof. Daniela Todorova, BG

Prof. Emilia Andreeva-Moschen, AT

Prof. Gordana Marunic, HR

Prof. Hristo Stanchev, BG

Prof. Igor Penkov, EE

Prof. Igor Smirnov, UA

Prof. Iliyan Lilov, BG

Prof. Lech Sitnik, PL

Prof. Lilo Kunchev, BG

Prof. Ljudmila Boyko, UA

Prof. Madaminjon Aripdzanov, UZ

Prof. Martin Kendra, SK

Prof. Massimo Borghi, IT

Prof. Murat Dogruel, TR

Prof. Natasa Tomic-Petrovic, RS

Prof. Nikolay Georgiev, BG

Prof. Oleg Sharkov, RU

Prof. Pepo Yordanov, BG

Prof. Polatbeg Zhumisbekov, KZ

Prof. Rosen Ivanov, BG

Prof. Teymuraz Kochadze, GE

Prof. Tomaz Morchadze, GE

Prof. Vadim Zhmud, RU

Prof. Valyo Nikolov, BG

Prof. Zoran Jovanovic, RS

CONTENTS

TRANSPORT TECHNICS. INVESTIGATION OF ELEMENTS. RELIABILITY

UNDERWATER HULL OBSERVATION SYSTEM ARMUS Academician Stefan Vodenicharov, Professor Dr. Daniel Bratanov, Dr. Rumyana Mihaylova, Professor Kiril Stoychev, DSc, Eng. Valentin Najdanov	215
IMPACT OF PARAMETERS OF POWER TRANSMISSION SYSTEM STATE ON VEHICLE'S WORKING LIFE AND POWER EFFICIENCY Dr Eng. Damjanovic M., Ass. Prof. Dr Eng. Sibalic N., Prof. Dr Eng. Vukcevic M.	219
ANALYSIS AND MODELLING OF AUTOMOTIVE AIR FILTER AS A SUBSTITUTE FOR POWERCORE ITEM Assoc. Prof. Kandrotaite Janutiene R. PhD, Lect. Masteika D. PhD, Prof. Bubulis A. Habil. PhD	223
DESIGN AND OPTIMISATION OF 2DOF VEHICLE SUSPENSION SYSTEM Prof.Asoc.Dr. Ramë Likaj, Prof.Asoc.Mirlind Bruqi, Msc.Mehmet Qelaj	227
THE STRESS VARIATION BY CHANGING THE SUPPORTING POINT LOCATION IN THE MOTOR VEHICLE CLUTCH ASSEMBLY M.Sc.Sasko Milevly*, Ph.D. Simeon Simeonov, Ph.D. Petar Simonovski, Ph.D. Nikola Avramov, Ph.D. Sasko Dimitrov, Ph.D. Slavco Cvetkov	230
RESEARCH AND ANALYSIS OF DYNAMIC PARAMETERS IN V-BELTS Azem Kyzyku, Nexhat Qelaja	235

TRANSPORT. SAFETY AND ECOLOGY. LOGISTICS AND MANAGEMENT

METHODICAL ASPECTS OF DETERMINING THE PROFITABILITY OF THE RAILWAY ROLLING STOCK OPERATOR Prokofieva Evgenia Ph.D, Ryzhenkov Andrey Ph.D	238
CONCENTRATION IN LINER SHIPPING AND ALLIANCES FORMATION: ISSUES AND CHALLENGES Senior Assistant Professor Varbanova A. PhD	241

THE STRESS VARIATION BY CHANGING THE SUPPORTING POINT LOCATION IN THE MOTOR VEHICLE CLUTCH ASSEMBLY

M.Sc.Sasko Milev^{1†}, Ph.D. Simion Simionov^{1†}, Ph.D. Petar Simonovski^{2†}, Ph.D. Nikola Avramov^{2†}, Ph.D. Sasko Dimitrov^{1†}, and Ph.D. Slavco Cvetkov^{1†}

^{1†} Faculty of Mechanical Engineering - Goce Delchev University in Stip, Macedonia

^{2†} Faculty of Mechanical Engineering – St.Cyril and Methodius University in Skopje, Macedonia

E-mail: sasko.milev@ugd.edu.mk;

Abstract: The diaphragm spring as one of the most important parts of the motor vehicles clutch assembly provides the compressive force on the pressure disk. This force is needed for generating friction between the coupling of the flywheel and the pressure disk and transmitting the torque from the engine to the transmission. Therefore the diaphragm spring is subjected to complex loads. The nominal stress for dimensioning the spring is the tangential stress, which is calculated by the terms of Almen and Laszlo. The aim of this research is analyzing the location of the diaphragm spring supporting points of the clutch assembly and its effect on the caused stresses by using the Finite Element Method.

Keywords: DIAPHRAGM SPRING, FRICTION CLUTCH, EXPRESSIONS OF ALMEN AND LASZLO, TANGENTIAL STRESS

1. Introduction

The clutch coupling allows the engaging and disengaging of the vehicle transmission. The required compressive force for creating the friction necessary for torque transmission is achieved by the diaphragm spring. When performing its function, the diaphragm spring is subjected to dynamic loadings. The stresses occurring at the spring are compression and extension, figure 1. [1],[2].

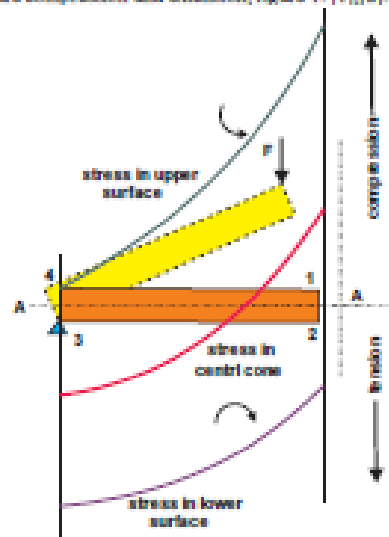

Fig.1 Spring stresses

The diaphragm spring use the clutch assembly couplings has the location of the supporting points as shown on the picture or in the case of a vehicle those are a supporting edges, figure 2.

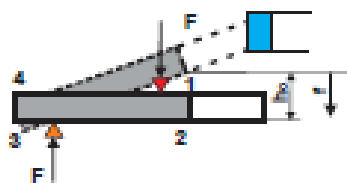

Fig.2 Diaphragm spring with its supporting points

By mounting the clutch in the vehicle, the shape of the spring changes, from its conical shape it becomes flat (it makes a deviation $f = h_0$), and then the process of spring loading starts. The spring has

two points of interest. Point 1 where the force F acts (created by the spring deflection) and the point 3 where the spring is supported, where the force is also equal to F. When the spring is in the flat position, the compression force allows the torque to be transmitted. Moving the release bearing for a certain path (deflection) causes the clutch to disconnect [3], [4].

2. Researching

The purpose of this research is by using the finite element method to determine the spring stress depending on the location of the supporting points in both the flat or mounted position and at the maximum deviation or disengaged position.

The analysis were carried out on a diaphragm spring for commercial vehicles with next dimensions : internal diameter of a diaphragm spring $D_i = 313$ [mm], outer diameter of a diaphragm spring $D_o = 395$ [mm], spring thickness $s = 5.2$ [mm], Module of elasticity of the steel $E = 206000$ [N/mm²], Poisson number of spring steel $\mu = 0.3$, internal diameter of the diaphragm spring with supporting points $D_{is} = 336$ [mm], outer diameter of the diaphragm spring with supporting points $D_{os} = 392$ [mm], path of the clutch while disengaging $\ell = 12$ [mm], release bearing diameter $d = 120$ [mm]. [5], [6]

Figures 3 and 4 shows the distribution of forces acting on the spring, with one and two supporting points used for the clutches.

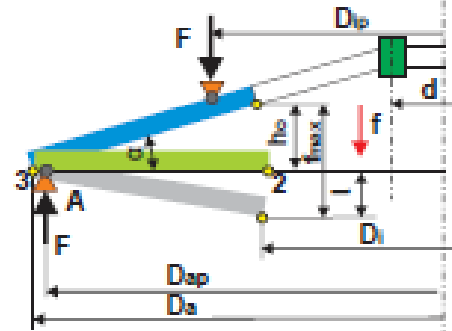

Fig.3 Spring with one supporting point

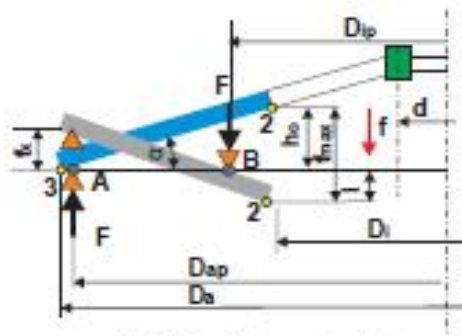

Fig. 4 Spring with two supporting points

In order to note the influence of the supporting points, the spring calculation was performed:

- supporting point A, by moving the spring from the initial or zero position to the flat position, the spring makes a deviation h_0

The supporting point A is stationary, and the release bearing moves the spring from the flat position for the path l that disengages the spring (maximum deviation is achieved)

- From the two supporting points A and B, in the flat position of the spring, the supporting point B is stationary. The release bearing moves from the flat position for the path l , and the point A travels the distance h_0 , and within this displacement the pressure disk is raised and the clutch is disengaged.

By using a Finite Elements Method (commercial software package), the spring cross-section is divided into 21 elements (Fig. 5) in which the stress is calculated. From the simulation results, the following diagrams for the tangential stress for two cases (Fig. 6 and 7) were obtained:

- The support point A is on a diameter of $\varnothing 392$ [mm], and the internal diameter $D_i = 313$ [mm] moves from the initial position to the flat position (h_0) and to a maximum deviation of h_{max} .

- The support point A is on a diameter of $\varnothing 392$, and the supporting point B is on the diameter of $\varnothing 336$ [mm]. From the flat spring position, point B is stationary and point A moves in opposite direction from the direction of the release bearing that travels the distance l , [7].

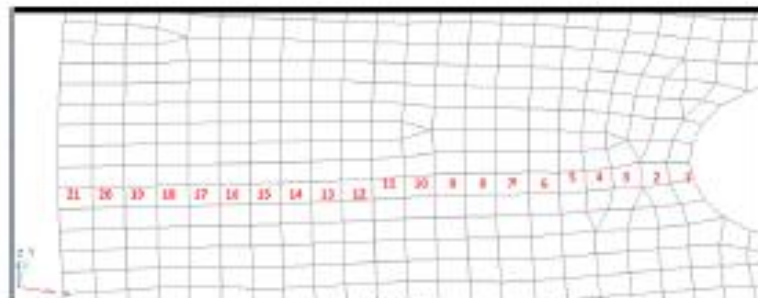

Fig. 5 FEM elements for stress calculation

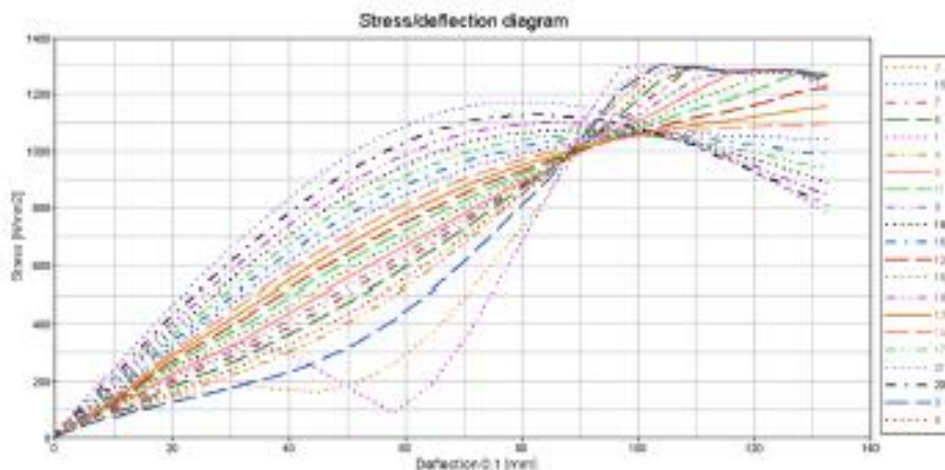

Fig. 6 Diagram of tangential stresses with a support point A.

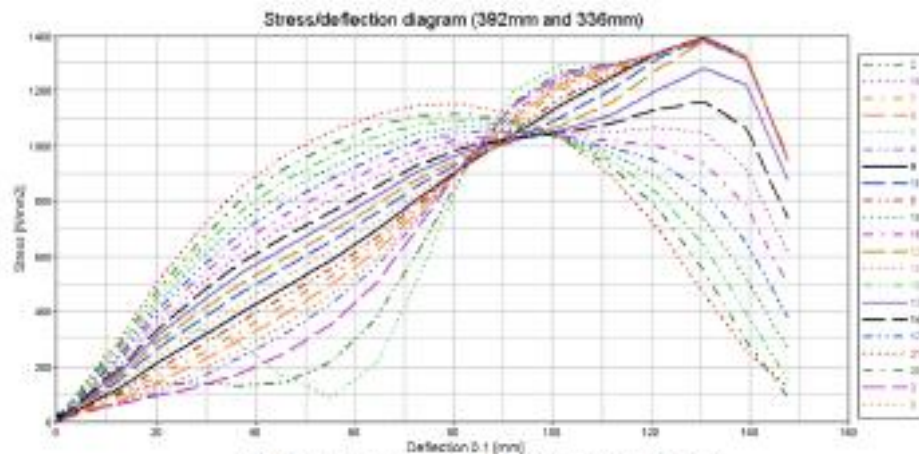

Fig 7 Diagram of tangential stresses with two supporting points, A and B

Complex stresses are presented at figures 8 and 9 :

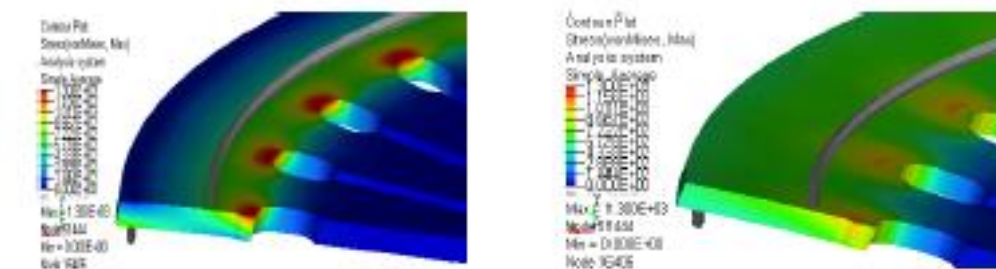

Fig 8 Complex stress at the flat and damaged position (0392/0)

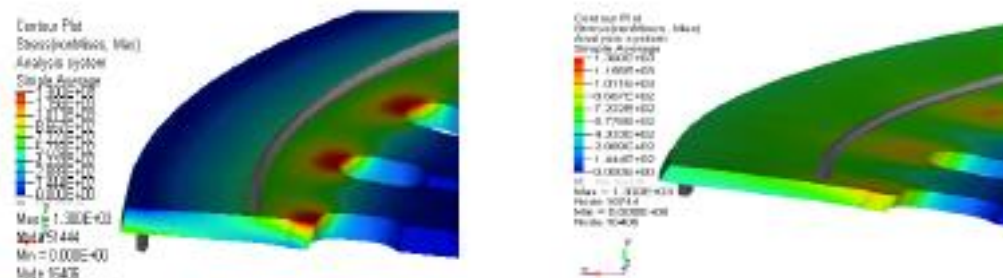

Fig 9 Complex stress at the flat and damaged position (0392/336)

3. Analysis of the results and discussion :

The calculations were carried out by the FEM and the obtained diagrams (Fig. 6 and 7), for the change in the tangential stresses of the diaphragm spring body shown on the diagrams (Fig. 10 and 14) and the tables (1 and 2) were analyzed [4], [7].

Table 1: Tangential stresses at the spring flat position

393,0	392,0	390,2	381,3	369,5	358	346,2	334,5	322,7	315	D(mm)
8,86	8,75	8,55	7,57	6,27	5,0	3,7	2,4	1,1	0,22	f(mm)
1130		1120	1060	870	640	410	190	60	30	Ø330/336 $\sigma(N/mm^2)$
1170		1120	1055	870	645	410	230	80	35	Ø330/0 $\sigma(N/mm^2)$

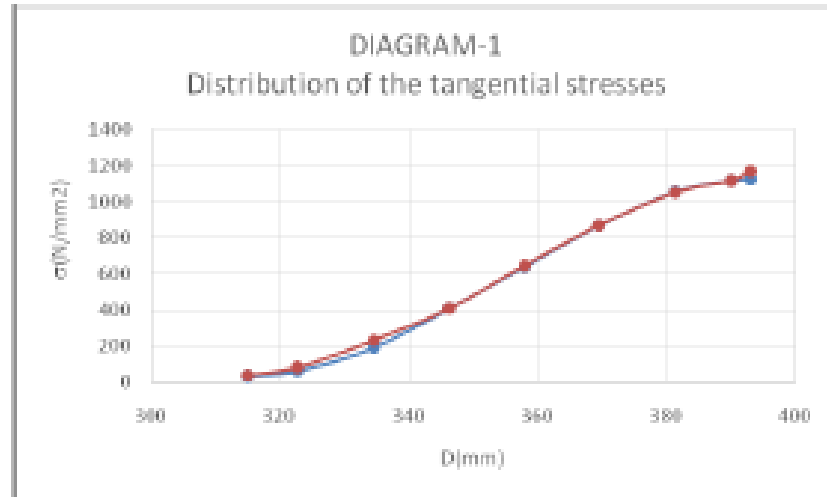

With one support _____, with two supports _____
Fig. 10 Distribution of the tangential stress at the flat position of the spring

Table 2: Tangential stresses at the spring disengaged position

393,0	392,0	390,2	381,3	369,5	358	346,2	334,5	322,7	315	D(mm)
2,8		3,2	3,7	4,3	5	5,6	6,5	8,13	9,8	f(mm)
130		370	500	620	540	570	740	1120	1280	Ø330/336 $\sigma(N/mm^2)$
12,35	12,23	12,0	10,57	8,77	7,0	5,15	3,33	1,51	0,28	f(mm)
885		920	1060	1050	850	575	300	110	50	Ø330/0 $\sigma(N/mm^2)$

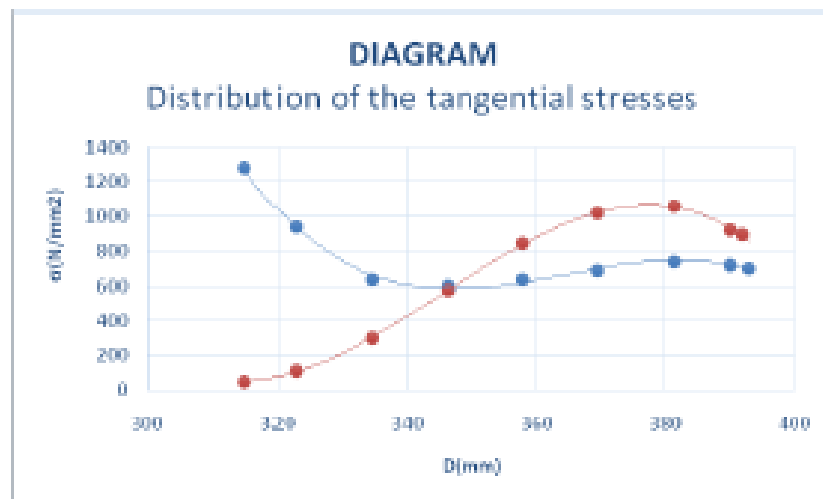

With one support _____, with two supports _____
Fig. 11 Distribution of the tangential stress at the disengaged position of the spring.

The highest tangential stress occurs in point 2 (if the supporting point is placed on the location of point 2), then it has the greatest deviation plus the deviation from the displacement of the release bearing traveling the distance of $\ell = 12\text{mm}$ ($\ell_{\text{max}} = 7,85 + 4,9 = 13,7\text{mm}$). This can be seen from the picture of the complex stress (Fig.12).

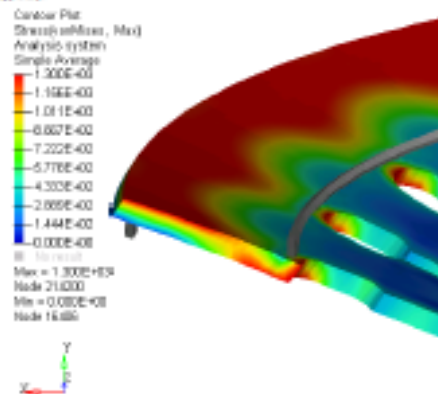

Fig.12 Complex stress at the disengaged position 0392/0313

4. Conclusion :

The following conclusions can be given:

- The stress at flat spring position with one and two supporting points has small deviation of one curve compared to the other.
- The stress at the maximum spring deflection has the mutual variation of the curves. With one support, the maximum stress occurs in the region of the point 3, and with two supports around the location of the point 2. The reason for this is that in the first case, the diaphragm spring is inclined like a beam fixed on one of its sides, and in the second case the spring is inclined on two supports.

References

- [1] Orthwein C.William *Clutches and brakes : Design and Selection* CRC Press, 2 edition (2004)
- [2] Nan W., Lee H., Chai Y.C. and Kwon D.J. *Finite Element Analysis and Optimal Design of Automobile Clutch DiaphragmSpring*. FISITA World Automotive Congress, Seoul, 2000-05-0125
- [3] *Mubea Disc Spring Handbook* (1992), Catalogue.
- [4] Almen J.O. and Laszlo A. (1936). The Uniform-Section Disk Spring. (1936), *ASME* 58.
- [5] Kaya, N. Optimal design of an automotive diaphragmspring with fatigue resistance. *International Journal of Vehicle Design*. (2006) 126-43. Vol.40.
- [6] Nurney, Malcom J. *Light and Heavy Vehicle Technology* 4th ed. (2001) Elsevier Ltd., London.
- [7] Cook D. Robert *Finite Element Modeling for Stress Analysis* Wiley, 1st edition (1995)