

**2<sup>nd</sup> International Scientific Conference**

**CONTEMPORARY ISSUES  
IN ECONOMICS, BUSINESS AND  
MANAGEMENT - EBM 2012**

**Conference Proceedings**

**Edited by  
Verica Babić, Ph.D.**

**FACULTY OF ECONOMICS  
UNIVERSITY OF KRAGUJEVAC  
Kragujevac, 2013**

# CONTEMPORARY ISSUES IN ECONOMICS, BUSINESS AND MANAGEMENT

---

## *Publisher*

Faculty of Economics University of Kragujevac

## *For the Publisher*

Verica Babić, Ph.D. – Dean

## *Edited by*

Verica Babić, Ph.D.

## *Computer Support*

Blaža Mitrović

CIP - Каталогизacija у публикацији  
Народна библиотека Србије, Београд

005(082)(0.034.2)  
339.9(082)(0.034.2)  
341.232(082)(0.034.2)  
336.6(082)(0.034.2)

INTERNATIONAL Scientific Conference Contemporary Issues in  
Economics, Business and Management - EBM 2012 (2 ; 2012 ;  
Kragujevac)

Conference Proceedings [Elektronski izvor] / 2nd International  
Scientific Conference Contemporary Issues in Economics,  
Business and Management - EBM 2012, Kragujevac ; edited by  
Verica Babić. - Kragujevac : Faculty of Economics University,  
2013 (Kragujevac : Faculty of Economics University). - 1  
elektronski optički disk (CD-ROM) : tekst ; 12 cm

Sistemski zahtevi: Nisu navedeni. - Nasl. sa naslovnog ekrana. -  
Tiraž 200. - Napomene i bibliografske reference uz tekst. -  
Bibliografija uz svaki rad.

ISBN 978-86-6091-037-2

1. Babić, Verica [urednik]  
a) Менаџмент - Зборници b) Глобализација - Зборници  
c) Регионализација - Зборници

## FOREWORD

The international scientific conference on Contemporary Issues in Economics, Business and Management (EBM) has become a significant event for scientific and professional community of Southeastern Europe, organised by the Faculty of Economics – University of Kragujevac. The Conference traditionally draws attention of researchers and professionals from Serbia and other countries. The objective of this biennale scientific meeting is building research capabilities and thus improving the quality of research results in the fields of economics, business and management, as well as enabling academics, researchers and PhD students to share their knowledge and valuable experiences, to address important questions, but also to raise new ones. Challenges of ongoing global economic crisis, turbulent business environment and increasing competitiveness require new, progressive thinking on economic policy and new business models that will create the change we want to see and finally lead to innovative solutions of various business issues. Therefore, the EBM Conference is a great platform for networking among researchers from different countries, for exchange of ideas and substantial contribution to the development of existing theory and practice.

The EBM 2012 Conference gathered around 120 participants, mostly from the Western Balkans countries and EU. Within plenary and four parallel sessions, the authors have presented their most recent papers that related to theoretical, methodological and practical research.

This book represents conference proceedings and consists of four parts. The first part includes papers dealing with key topics in contemporary management and marketing while the second part addresses challenges related to globalization and regionalization. The focus of the third part is associated with contemporary concepts and issues in accounting and business finance. The fourth part contains papers that utilize quantitative methods and models in economy and management.

I would like to thank all contributors for creating an impressive book that further advances traditional concepts in economics and opens new research perspectives. I also owe many thanks to paper reviewers for their enthusiasm, diligence and constructive comments that have provided the authors with guidelines for improving the quality of their papers, and thus the publication itself. Therefore, I strongly believe that the conference proceedings will fulfil their intention to serve to the readers as a helpful resource for their scientific work and further research efforts.

Editor  
Verica Babić





# CONTENTS

## KEY ISSUES IN MANAGEMENT AND MARKETING

ORGANIZING FOR PERMANENT WHITEWATER: WHAT MUST THE WEST DO IN ORDER TO COMPETE IN THE GLOBAL KNOWLEDGE ECONOMY? <b>Svenn-Are Jenssen, Jon-Arild Johannessen, Bjørn Olsen</b> .....	3
ORGANIZATIONAL PERFORMANCE – THE IMPACT OF MANAGERIAL POTENTIAL AND INNOVATION <b>Aziz Šunje, Muamer Bezdrop, Emir Kurtić</b> .....	21
THE IMPACT OF ORGANIZATIONAL CULTURE ON MOTIVATION <b>Nebojša Janićijević</b> .....	37
BOARD STRUCTURE AND CORPORATE PERFORMANCE: TRADITIONAL VS. CONTEMPORARY APPROACH <b>Verica Babić, Jelena Nikolić, Jelena Erić</b> .....	49
CULTURAL INFLUENCES ON REWARD SYSTEM IN ORGANIZATIONS <b>Dušan Mojić</b> .....	65
NEW FORMS OF INSTITUTIONAL ARRANGEMENTS: THE CASE OF RAPP ZASTAVA (NORWAY – SERBIA) <b>Momčilo Đorđević</b> .....	73
HEALTHCARE AND PROCUREMENT MANAGEMENT – ISSUES WITHIN THE SERBIAN MARKET <b>Slobodan Aćimović, Veljko Mijušković</b> .....	85
STRATEGIC COST MANAGEMENT AS A REPLY TO CHALLENGES OF MODERN BUSINESS ENVIRONMENT <b>Violeta Domanović, Vesna Stojanović-Aleksić</b> .....	97
PERFORMANCE MANAGEMENT OF SMALL AND MEDIUM ENTERPRISES IN THE FUNCTION OF ACHIEVING OF SUSTAINABLE DEVELOPMENT <b>Tatjana Stevanović, Marija Petrović-Randelović</b> .....	111
INVESTIGATING CORPORATE ENTREPRENEURSHIP IN SERBIAN CONTEXT <b>Ljiljana Kontić</b> .....	121
MEASURING CUSTOMER SATISFACTION <b>Branko Maričić, Saša Veljković, Aleksandar Đorđević</b> .....	129
MONITORING HEALTH RESORT CUSTOMERS' SATISFACTION AND EXPECTATIONS ON THE EXAMPLE OF THE CUSTOMERS OF THE INNOVATIVE CLUSTER OF HEALTH AND TOURISM "HEALTH RESORTS - PEARLS OF EASTERN POLAND" <b>Jacek Rodzinka, Robert Gora</b> .....	141

THE MARKETING STRATEGIES OF POLISH EXPORTING COMPANIES ON INTERNATIONAL MARKETS	
<b>Jan Wiktor</b> .....	159
CREATING THE VALUE OF GLOBAL BRANDS IN THE LIGHT OF THE ANALYSIS OF THE "BEST GLOBAL BRANDS" RANKING	
<b>Pawel Chlipala</b> .....	167
SERBIAN CONSUMER ACCEPTANCE OF FUNCTIONAL FOODS: SOCIODEMOGRAPHIC AND ATTITUDINAL DETERMINANTS	
<b>Jelena Filipović, Žaklina Stojanović</b> .....	179
ETHICAL CONSUMER ACTION IN ACHIEVING SOCIAL AND POLITICAL GOALS	
<b>Dražen Marić</b> .....	189
RISK PERCEPTION IN CHOOSING A DESTINATION: A CROSS CULTURAL STUDY AMONG ISRAELI AND SERBIAN TOURISTS	
<b>Vladimir Senić, Veljko Marinković, Ella Gordon</b> .....	199
THE ROLE OF EVENTS IN STRATEGIC (RE)POSITIONING OF A TOURIST DESTINATION	
<b>Ilija Morić, Olivera Simović</b> .....	209
STRATEGIC IMPLICATIONS OF INTERNET MARKETING PLAN	
<b>Milan Kocić, Srđan Šapić, Velida Kijevčanin</b> .....	217
EMPIRICAL INVESTIGATION OF BRAND ORIENTATION IN THE NON-PROFIT SECTOR	
<b>Marija Mandarić, Dejan Sekulić, Nemanja Pantić</b> .....	227

## GLOBALIZATION AND REGIONALIZATION

POST-CRISIS STRUCTURAL IMBALANCE – THE CASE OF SERBIA	
<b>Edvard Jakopin, Mirjana Knežević</b> .....	241
THE INTERACTION OF THE PROCESS OF TAXATION AND THE INTERNATIONAL TRANSACTIONS	
<b>Srđan Đinđić</b> .....	255
EXCHANGE RATE REGIMES AND REAL EXCHANGE RATE IN THE WESTERN BALKAN COUNTRIES	
<b>Vasilj Žarković, Dragan Gligorić, Jelena Tešić</b> .....	267
INDUSTRIAL POLICY IN TRANSITION – OBSOLETE IDEA OR THE NEED IN POST-CRISIS CONDITIONS	
<b>Vladimir Mičić</b> .....	279
ALTERNATIVE APPROACHES TO RISK MANAGEMENT IN INSURANCE COMPANIES	
<b>Milena Jakšić, Violeta Todorović, Milka Grbić</b> .....	289

SIZE AND LIQUIDITY OF STOCK MARKETS IN FORMER YUGOSLAVIA'S SUCCESSOR STATES	
<b>Dragan Stojković, Srđan Marinković</b> .....	<b>301</b>
ELECTRONIC BANKING ON THE EXAMPLE OF PIRAEUS BANK	
<b>Slavoljub Milovanović</b> .....	<b>313</b>
ROLE OF PENSION FUNDS IN THE FINANCIAL SYSTEM OF SERBIA AND COMPARATIVE VIEW WITH THE STATES OF SOUTH EAST EUROPE	
<b>Milena Lutovac, Miloš Lutovac</b> .....	<b>323</b>
COLLECTION MANAGEMENT AS CRUCIAL PART OF CREDIT RISK MANAGEMENT IN SERBIAN BANKING SECTOR	
<b>Lidija Barjaktarović, Dejan Ječmenica, Ana Vjetrov</b> .....	<b>331</b>
EUROPEAN QUALIFICATIONS FRAMEWORK: EXPERIENCES FROM SEVERAL EUROPEAN BANK TRAINING NETWORK (EBTN) MEMBERS	
<b>Sladana Sredojević</b> .....	<b>345</b>
GLOBALIZATION AND ITS IMPACT ON THE ECONOMIC POLICY – THE CASE OF THE REPUBLIC OF MACEDONIA	
<b>Pece Nedanovski, Predrag Trpevski</b> .....	<b>355</b>
THE EFFECT OF EUROPEAN MONETARY INTEGRATION ON REGIONAL TRADE	
<b>Nenad Stanišić, Nenad Janković</b> .....	<b>365</b>
CONTEMPORARY PROTECTIONISM, CRISIS AND THE ROLE OF WORLD TRADE ORGANIZATION	
<b>Jelena Tešić</b> .....	<b>377</b>
THE CHALLENGES OF POST CRISIS GLOBAL DEVELOPMENT – ROLE OF FAST GROWING MARKETS	
<b>Snežana Popovčić-Avrić, Marina Đenić</b> .....	<b>387</b>
GLOBALIZATION AND GLOBAL CURRENCY	
<b>Krste Sajnoski, Violeta Madzova</b> .....	<b>395</b>
INTRODUCTION OF COMPREHENSIVE PERSONAL INCOME TAXATION AS A POSSIBLE WAY TO IMPROVE TAX SYSTEM IN SERBIA	
<b>Stevan Luković</b> .....	<b>405</b>
BANKING FOR POOR AS A STRATEGY FOR LOCAL SUSTAINABLE TOURISM DEVELOPMENT	
<b>Zoran Temelkov, Marina Bojčeva, Darko Dimitrovski</b> .....	<b>415</b>
THE IMPORTANCE OF ECONOMIC DEVELOPMENT OF MODERN TOURISM IN SERBIAN RURAL AREAS	
<b>Jovica Mojić, Vukašin Šušić</b> .....	<b>427</b>
ANALYSIS OF BUSINESS PERFORMANCES DURING THE CRISIS PERIOD	
<b>Jana Subotić, Ana Vjetrov, Nemanja Vejnović</b> .....	<b>435</b>

EFFECTS OF FINANCIAL FLOWS UNDER GLOBALIZATION IN DEVELOPING COUNTRIES	
<b>Danijel Kokanović, Marina Stefanović Grubor .....</b>	<b>445</b>

## ACCOUNTING AND BUSINESS FINANCE

FINANCIAL REPORTING STANDARDS: THE ESSENCE AND SOCIAL ROLE	
<b>Vladimir Obradović, Radoslav Stefanović.....</b>	<b>457</b>
INTERNATIONAL CONVERGENCE IN PROFESSIONAL ACCOUNTING REGULATION	
<b>Ljiljana Dmitrović Šaponja, Sunčica Milutinović, Saša Gravorac.....</b>	<b>467</b>
FRAUDULENT FINANCIAL REPORTING – ESSENCE, MOTIVES AND METHODS	
<b>Dragomir Dimitrijević .....</b>	<b>481</b>
FROM ACTIVITY-BASED COSTING AND TARGET COSTING TO THE REALIZATION OF COST LEADERSHIP STRATEGY	
<b>Ljilja Antić, Bojana Novičević .....</b>	<b>493</b>
FOREIGN CURRENCY TRANSLATION – KEY ISSUE IN INTERNATIONAL ACCOUNTING	
<b>Ljiljana Dmitrović Šaponja, Jasmina Bogičević.....</b>	<b>503</b>
THE IMPACT OF FOREIGN CURRENCY TRANSLATION ON FOREIGN SUBSIDIARY PERFORMANCE	
<b>Jasmina Bogičević, Violeta Domanović, Slavica Manić .....</b>	<b>513</b>
MANAGEMENT ACCOUNTING ASPECT OF ENVIRONMENTAL COSTS	
<b>Dejan Jovanović, Marina Janković .....</b>	<b>525</b>
FINANCIAL BENCHMARKING: VALUE DRIVERS ANALYSIS	
<b>Dijana Sredić, Tajana Serdar.....</b>	<b>539</b>
THE GLOBALIZATION OF PROFESSIONAL ACCOUNTANTS EDUCATION AND THE ACHIEVED LEVEL IN SERBIA	
<b>Slobodan Malinić, Vesna Janjić, Mirjana Todorović .....</b>	<b>559</b>

## QUANTITATIVE METHODS AND MODELS IN ECONOMICS AND MANAGEMENT

THE EUROPEAN QUALIFICATION FRAMEWORK AS A BASE FOR STUDY PROGRAM MODELLING AND ANALYSIS	
<b>Paweł Lula.....</b>	<b>575</b>

STOCK MARKET INDEX FORECASTING USING NEURAL NETWORK MODELS: STUDY OF BELGRADE STOCK EXCHANGE <b>Zoran Kalinić, Zora Arsovski, Vladimir Ranković, Igor Milanović, Dragana Rejman Petrović.....</b>	<b>589</b>
CDS SPREADS, PROBABILITIES OF DEFAULT AND RISK PREMIUMS IN THE LATEST DEBT CRISIS <b>Irena Janković .....</b>	<b>601</b>
THE APPLICATION OF FAIR VALUE TO BALANCE SHEET VALUATION OF STOCKS IN POLISH ECONOMIC REALITIES <b>Paweł Bielawski .....</b>	<b>615</b>
DIMENSIONALITY REDUCTION OF TIME SERIES DATA BASED ON SAX REPRESENTATION <b>Marina Milanović, Milan Stamenković, Zlata Đurić .....</b>	<b>629</b>
IT SERVICE MANAGEMENT USING HP ITSM REFERENCE MODEL <b>Milica Stanković, Danijela Glušac, Jelena Vojinović.....</b>	<b>643</b>
VALUE AT RISK DYNAMIC PORTFOLIO OPTIMIZATION USING GENETIC ALGORITHM: EQUALLY VERSUS EXPONENTIALLY WEIGHTED HISTORICAL VAR APPROACH <b>Vladimir Ranković, Mikica Drenovak, Zoran Kalinić, Zora Arsovski.....</b>	<b>653</b>
RESAMPLING STATISTICS – BOOTSTRAP <b>Nataša Pešić Radosavljević, Nenad Tomić.....</b>	<b>663</b>



# **KEY ISSUES IN MANAGEMENT AND MARKETING**





# ORGANIZING FOR PERMANENT WHITEWATER: WHAT MUST THE WEST DO IN ORDER TO COMPETE IN THE GLOBAL KNOWLEDGE ECONOMY?

Svenn-Are Jenssen<sup>1</sup>

Jon-Arild Johannessen<sup>2</sup>

Bjørn Olsen<sup>3</sup>

**Abstract:** *In order to figuratively represent the development of organizations over the last hundred years, we may say that there has been an evolution from stable organizations, which we might call “frozen pyramids”, to the emergence of “small portable tents”. These small portable tents may be related to the emerging Lego-like structures which may be observed in the contours of the present global knowledge economy. This is the general trend confronting organizations today. The problem we examine here is: What should the West do in order to compete in the global knowledge economy? The answer we present is threefold: Firstly, organizations need to take into account that the relevance and value of our fundamental experiences have collapsed, and that a change is taking place from hierarchical management structures to organizations based on a front-line focus. Secondly, organizations must also understand that the relevance of experiences collapses in light of the technological changes and new value creation processes which are emerging in the knowledge economy. Last, but not least, organizations need to develop a system to “see” where innovations will emerge in order to make superior profits. These three requirements trigger separately and jointly the need for innovative leadership in organizations.*

**Keywords:** *Front-line focus, new value creation processes, Lego-like organization, info-structure, innovative leadership, emerging innovations.*

## Introduction

Innovative leaders assume leadership roles in order to develop micro-innovation fields, i.e. creative energy fields (Gratton, 2007) in organizations, thereby stimulating enthusiasm and energy in other employees and resulting in innovation. Metaphorically speaking, innovative leaders may be said to be the spark plugs in such micro-innovation fields, triggering explosions and driving the system towards innovation and organizational entrepreneurship. The innovative leaders ignite change processes which Gratton (2007) terms “hot spots”; Taylor & La Barre (2007) talk of the importance of “mavericks”, while Collins (2001) uses the analogy of a “flywheel”.

There are some indications that the classical organizational hierarchy is crumbling and being replaced by the importance of competence networks, locally, regionally and globally. These competence networks are taking over the design, manufacture and distribution of products and services. It also seems to be the case that decision-making processes are being significantly shortened; and that, in many cases, decision-making will henceforth be carried out on the “front line”, i.e. by those who are closest to activities. In a front-line organization, an organization’s decisions are centralized at the front line. Ideally, there will be complete interactivity between the competence of those working on an organization’s front line and its customers.

---

<sup>1</sup> Bodø Graduate School of Business, University of Nordland.

<sup>2</sup> Oslo School of Management, Harstad University College.

<sup>3</sup> Bodø Graduate School of Business, University of Nordland.

## **ORGANIZING FOR PERMANENT WHITEWATER: WHAT MUST THE WEST DO IN ORDER TO COMPETE IN THE GLOBAL KNOWLEDGE ECONOMY?**

---

Such a development will, in all probability, lead to the value and relevance of an organization's own experiences collapsing. The question is: What happens when the importance and relevance of many of our basic and fundamental experiences collapse? Perhaps our ideas and expectations will be given more room to flourish in our everyday lives?

Innovation and the application of various forms of new technology make the development of agile organizations possible, illustrated metaphorically by the small portable tent that can be quickly moved around in the global knowledge economy. When the value of our basic experiences has been eroded, it is reasonable to assume that, at the level of the individual, a feeling of chaos and a loss of footing will prevail, and also possibly a growing sense of meaninglessness will develop (Sennet, 1998, 2004; 2006). More and more people will realize that they have to find an answer to the question: "What do I need to learn so that I can decide where to go next?" (Drucker, 1995: 5). Although the "frozen pyramid" organizations of the twentieth century may have melted down, theoretically making everything possible, the resulting "freedom" for individuals may become overwhelming, frustrating and anxiety-creating (Sennett, 2006; Bauman, 1996, 2000).

It is reasonable to assume that the employee's feeling of solidarity with, and confidence in, organizations will evaporate in such a situation (see Sennet 122-130); and although the frozen pyramids characterized much of the 20th century, it now seems as if "migration is the icon of the global age, moving on rather than settling in" (Sennet, 2006: 2). The social atomization which this development leads to will affect all levels of society. However, there are several factors that indicate that this will also lead to "greater economic inequality as well as social instability" (op.cit.). When the value of basic experiences collapse, new value creation processes will be real, and new ways of organizing will develop; Sennet (2006:4) notes that at the individual level, there are three challenges that will be important to deal with:

1. How are you to deal with temporary employment relations?
2. How do you develop new skills when you do not know what will be in demand tomorrow?
3. How do you cope with the future given the collapse of the relevance of your basic experiences?

If you fail to respond satisfactorily to these questions, then resignation, passivity, uncertainty and the fear of being made redundant by the ongoing radical changes could easily be the result.

One of the consequences which Sennet points out, as we see it, is that individuals must take greater responsibility for their own careers and futures. We believe this creates more optimal conditions for entrepreneurial action, creating what is new, which would not have been created if someone had not actively taken part in the creative development process. The entrepreneurial action includes both what the academic literature terms innovation and corporate entrepreneurship (in turn also sometimes called corporate venturing), as well as independent entrepreneurship.

Another consequence of the collapse of the relevance of our basic experiences may be that the authority and status of the leader of the hierarchical organization will crumble. It is reasonable to imagine that authority, status and titles are likely to mean less as mobility increases. Gaining control of one's own career development, social competence (Goleman, 2006) and emotional competence (Drucker, 1995: 7) will come to be just as important as professional competence. An important point is that all three domains of competence can be developed and improved.

Drucker (1996: 13) suggests a trend towards front-line organization in the following way: "changing an organization from the flow of things to the flow of information". As societies, businesses and positions become increasingly impermanent (see Bennis and Slatter, 1968), knowledge of this information flow will become critically important, because the changes will be so pervasive and fundamental. It is the needs, wishes and preferences of customers, users, patients, students, etc. that will largely constitute the stock of critical information which it will be important to have knowledge

of. This will lead, amongst other things, to new value creation processes emerging, and innovations emerging in conjunction with these new value creation processes.

This critical information can be developed into products and services. A continuous interaction and interplay of ideas, production and marketing creates a disciplining of the innovation process whereby the customers' needs, wants and preferences are in focus the whole time, not only their present needs. An important point is to make the distinction between, demand on the one hand, and customers' needs and preferences on the other. This distinction develops flexibility, because adjustments can always be made between the market and the future market. In practice, the consequence may be that the time from idea to invoice will be greatly reduced. The question examined here is: *What should the West do to in order to compete in the global knowledge economy?*

The following model summarizes this introduction, and shows how the article is organized.

**Figure 1: Innovative leadership**

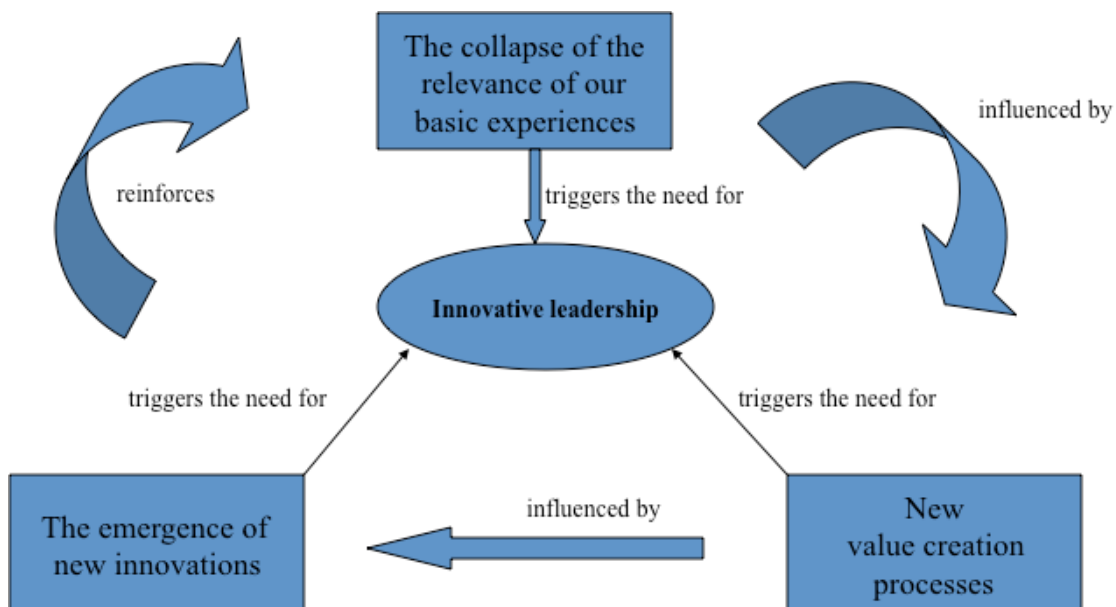

**The collapse of our fundamental experiences**

We plan our everyday lives on the basis of our past experiences. This applies to both the level of the individual, and the organizational level. Csikzentmihaly (1978: 339) expresses this as follows: “Only those items which I notice shape my mind”. What happens when we can no longer use past history and experiences as a foundation for our future plans and actions? It is this question – which relates to the sub-heading above, “The collapse of our fundamental experiences” – which we will reflect on here. We will examine how the collapse of the relevance of our basic and fundamental experiences affects the organization of enterprises, and how it affects our way of thinking.

When there is great stability and the pace of change is relatively small, what we experience and learn in the present may be applied to plans for the future. In such contexts, the passage of time does not have such a great power to erode the value of what we have learned or experienced. However, when change, complexity and turbulence are great, then what we have learned and experienced in the

## **ORGANIZING FOR PERMANENT WHITEWATER: WHAT MUST THE WEST DO IN ORDER TO COMPETE IN THE GLOBAL KNOWLEDGE ECONOMY?**

---

past will have less value in providing guidelines for future plans and actions. In such a situation, the importance of the present moment emerges as a social mechanism for organization and planning. To seize the opportunities that offer themselves in the present moment seems to be a key success factor when the relevance of basic and fundamental experiences collapses. Jack Welch, CEO of General Electric for twenty years, expressed a similar sentiment in 1999: “You can’t predict anymore. But that doesn’t matter. What is important is that you must be able to adapt and exploit; be agile enough to guess where the value is going ...” (cited in McGrath & MacMillan, 2000: 302-303).

Welsh’s being “agile”, being able to turn around quickly, seize opportunities and act in the moment, seem to be characteristics that ensure success, and will be important in the global knowledge economy. This applies also to large companies, when the pace of change increases. Here the explanation is that experiences and lessons learnt in the past will come to have less value, because they may not be used to the same extent as before when planning and predicting. Plans and historical data will, at best, be de-emphasized as a management tool. Ideas and expectations will become more pronounced as relevant social catalysts of action. When beliefs and expectations become more important, we must increasingly learn to live with the creative chaos, seize opportunities that arise in the moment and design organizations that are agile and quick to turn around. It is therefore important to find connections in the so-called perceived chaos. This may be the hallmark of successful organizations in the knowledge society.

On the other hand, plans, historical data and analysis are important instruments when stability is great. Management can then be achieved through strategic plans, predictions and a bureaucratic system that controls, checks and tests data and information against established knowledge, rules and procedures. This is the hallmark of successful organizations in the industrial society.

One explanation as to why industrial society’s organization and management forms still exist in the knowledge society is the effect of the element of “time-lag” in history; in other words, that which was once functional tends to maintain and reinforce itself, even though the problems which the functions provide a solution to have long since disappeared or been altered. This may offer one explanation as to why there is a time lag between management and organizational forms that once were effective, and the rise of new management and organizational forms. History’s “time-lag” may also provide an explanation as to why institutions try to perpetuate the problem which they see themselves as providing the solution to, even if the problem has ceased to be a “real” problem. Although the pace of change is great, it will always be necessary to maintain a stable core, because without a stable core, even creative chaos will end in confusion and destruction. At the individual level, the stable core will most likely consist of a few fundamental relationships. At the organizational level, the stable core will constitute the purpose the organization was designed for. We have tried to figuratively illustrate the stable core in Figure 2.

There is an erosion of character at the level of the individual, notes Sennet (1998). At the social level, structures erode, Bauman (2000) argues. On the organizational level, it is reasonable to assume that there is a transformation from hierarchical power structures to front-line organization in which power and decision-making are to a great extent transferred to the front line. The front line in an organization constitutes those employees who are in direct contact with customers, users, patients, students, etc. The front line consists also of those in the immediate vicinity of production (see Morgan and Liker, 2006). However, it would be incorrect to assume that power disappears. It is rather the case that it moves from position to function. It is reasonable to assume the power of decision-making moves from the hierarchical structure to the front line.

Those who have tried to sail a boat in a storm know that the ballast is a necessary prerequisite for managing this manoeuvre. However, the ballast must be placed in the bottom of the boat, in the keel, as close as possible to the elements. This is analogous to an organization with a top-heavy hierarchy, which will quickly topple when the pace of change is tumultuous, and organizations are forced to steer through “permanent whitewater”. Therefore, as part of this process we also see

structural changes in organizations. This change may be described as a transition from a hierarchical structure, in which power was concentrated and centralized in the top of an organization, to increasing focus on processes, information, power and decision-making in the front line. To continue the sailing analogy, this resembles aiming for the lowest possible center of gravity, when the storm is blowing at its worst, and organizations are forced to steer through a lengthy storm.

Figure 2: The stable core

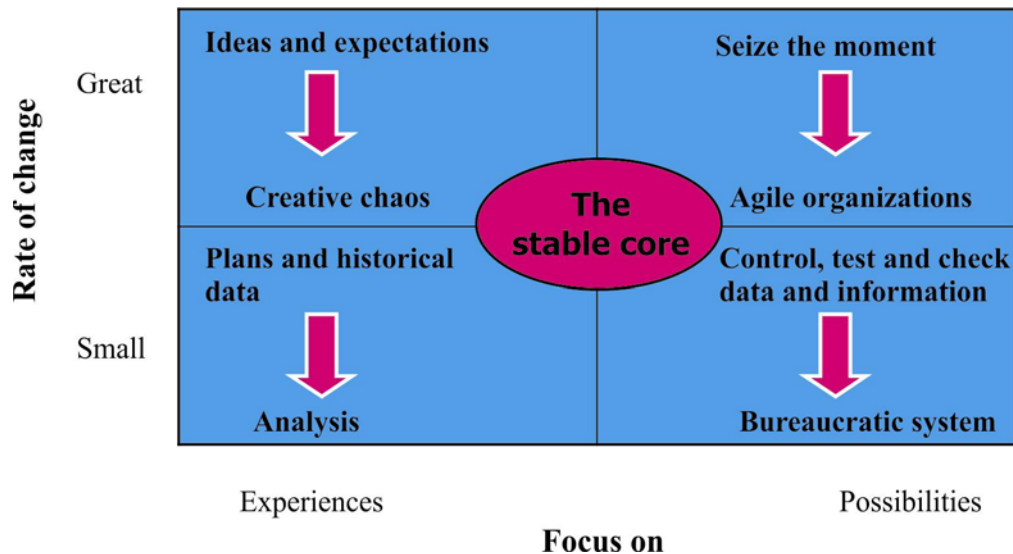

In the old order, rational bureaucracies superseded irrational feudal structures. In the new order we are entering a period characterized by the collapse of the relevance and value of our fundamental experiences. A transformation from rational hierarchies to agile, creative organizations with innovative leadership is taking place. The ideal is that the creative energy fields of such organizations will flourish on the front line, and create value through direct interaction with customers, users, patients, students, etc.

The old order's rational bureaucratic hierarchies were characterized by instrumental rationality. In the new order, often referred to as the global knowledge economy, it is systemic rationality that is most prominent. Systemic rationality is characterized by relationships, social and emotional skills, an understanding of patterns and a relationship between the parts and the whole. This involves a type of what we may call T-competence, where the vertical line of the letter T denotes analytical skills and the horizontal line denotes relationship expertise.

In the modern era, the economic system also functioned as a model for other systems in society; the "economic" way of thinking penetrated all areas of society. In the new order, the economy remains important, but it must interact to a greater extent with political, cultural and social systems. This is one of the reasons why companies employ anthropologists, social scientists, philologists, historians, etc to a greater extent than before. The economic system colonized every other system during the modern period. Analogously, it may be said that a de-colonization process is taking place as part of the transition to the new order. This is not because it is more "democratic", but rather because it functions as a more efficient system when the relevance and value of our fundamental experiences are collapsing.

## **ORGANIZING FOR PERMANENT WHITEWATER: WHAT MUST THE WEST DO IN ORDER TO COMPETE IN THE GLOBAL KNOWLEDGE ECONOMY?**

---

Prigogine (1997) refers to the new order as “the end of certainty”, where chaos is an important factor to consider. He also sees a transition from one type of rationality to another type of rationality, as characterizing the new order. Instrumental rationality tells us that an event is caused by a past event, so that “every event can be explained or predicted....” (Prigogine, 1997:1). When the relevance of our fundamental experiences collapses or is reduced, then the power of the aforementioned explanatory model also collapses or is reduced. It is thus not possible, at least not to the same extent as before, to use the past, history, experiences<sup>4</sup>, as an explanatory model for future actions. We have entered a new type of risk society, to borrow Ulrich Beck’s concept (Beck, 1992).

The new explanatory model is perceived as being chaotic and fragmented. In reality it is only a shift from a focus on the past, history and experiences to ideas, expectations, and an understanding of relations and patterns, i.e. a shift to a systemic explanatory model.

Just as the past affects history, and history affects our experiences, so do our ideas affect our expectations. Expectations form in turn the foundation for our understanding of patterns.

When the relevance of our fundamental experiences collapse, then we are only to a lesser extent able to use the past, history, and experiences as the basis for our strategic choices. Organizations need to a greater extent to use strategies based on ideas, expectations and understanding of patterns. This suggests that strategic thinking will change character. In practice this means that the focus will turn more towards creating the system’s future, and there will be a reduced focus on positioning by adapting to what others have created (see Ackoff et al., 2006).

When the value of our basic experiences collapse, we can no longer base our thinking on “the arrow of time” (see Prigogine, 1997: 1). In the hierarchical bureaucratic system, order, stability and predictability are keywords. In agile organizations with a front-line focus, these concepts are laid to rest, because they are no longer relevant to value-creating processes; indeed, in the worst case, the application of them may even lead to insolvency, even if productivity is high until an organization’s final death throes. The explanation is that high productivity alone is not a guarantee for survival, when markets change quickly. High productivity is a necessary but not sufficient condition for survival in the global knowledge economy. The sufficient factor is innovation. High-tech value creation is based on various types of innovation, including technological and organizational, and innovations involving markets, management and material.

If organizations and other social systems do not change their explanatory models and dominant logic, they risk becoming rigid systems. Rigid systems are characterized by the fact that they can easily break apart when even small innovations enter the market. Agile organizations, however, are organized around a stable core, so that their subsystems function in relation to a more creative and chaotic rationality, and are only loosely connected to the stable core. They can be thought of as operating as an organization’s creative chaos, in which innovations and organizational entrepreneurship (corporate entrepreneurship and corporate ventures) make up the creative energy field of the company. This enables the establishment of both a culture of achievement in the stable core, and a culture of innovation in the creative energy fields within and outside the organization.

When the relevance of basic experiences collapse and hierarchical and bureaucratic structures are nevertheless maintained, the result is “Zombie institutions, they are dead and still alive” (Ulrich Beck ref. in Bauman, 2000: 6).

When the relevance of fundamental experiences collapse, more attention is focused on the outside world, and comparisons are made to an increasing extent with those who are successful on the global scene (which may explain the increasing attention “benchmarking” has received). However, it is not certain that something which results in success for some will also result in success for others in different situations and contexts. To search for and utilize other people’s success stories may prove to

---

<sup>4</sup> There is a clear distinction between the past, history and experiences (see Koselleck, 2002).

result in the opposite of success. It is still possible to go to the wall with the highest productivity in the industry, if the organization itself has not developed and used an energy field of creativity with attention focused on innovations. A good example of this phenomenon is the Swedish company FASIT. They had the highest productivity in the production of mechanical calculating machines, but ignored the new electronic calculating machines which entered the market. The end result was that FASIT went into liquidation even though they had had the market's highest productivity.

When the relevance of basic experiences collapse, it appears that many organizations look towards "universal comparison" (Bauman, 2000: 7). One of the results of this universal "benchmarking" is greater similarity in the way organizations think and act. At a time when an important competitive advantage is uniqueness, acting on the basis of comparisons with other organizations is probably not the best success strategy.

When the relevance of basic experience collapses, and the examples that earlier led to success become less important, what are we left with? Ghandi provides perhaps an answer to this question: "Everyone thinks of changing the world, but no one thinks of changing himself". Bauman (2000: 72) also has a ready solution: "what truly counts is staying in the race to the end".

Another transformation that creates tension in the global knowledge society is the transition from a focus on production to a greater focus on consumption (see Bauman, 1996). When consumption becomes more important, it is no longer needs that control actions, but the desires and satisfaction of the moment. If the wishes of the moment are to govern much of behaviour, then predicting changes will become a Sisyphean task. When the wishes of the moment govern consumption, then the individual's identity becomes identical to his/her taste at the time, representing the emergence of a narcissistic culture (see Lash, 1979).

In such a culture organizations will need to develop sensors that can provide signals about the small signs of change before they manifest themselves. Bauman (2000:85) comments that, "one needs to guard one's own flexibility and speed of readjustment to follow swiftly the changing patterns of the world out there".

There is a transition from what may be designated "heavy" organizations to agile organizations. The heavy organizations are hierarchically structured and highly visible in the corporate landscape. The models for these hierarchical organizations, and the way their representatives think, has become the dominant logic, and permeates our way of thinking. The agile organizations are not that visible in the corporate landscape. They are almost invisible, and they are connected through various loose relationships. They are distributed throughout physical space, scattered across different time zones and hardly follow the dominant logic of the present day. The conditions for the development of these "invisible" agile organizations that follow a "Lego-logic" are, first and foremost, new technology and strategic and organizational changes. However, it must not be imagined that "size does not matter" with regard to these agile Lego organizations; size and power still mean a lot, of course. It is more that they assume a different kind of size and power. Bauman (2000: 121) comments that, "Capital can travel fast and travel light and its lightness and mobility have turned into the paramount source of uncertainty for all of the rest". To reiterate, agile Lego-like organizations must not be confused with a change towards smaller organizations; instead such organizations represent another way of being large, which does not necessarily manifest itself in physical space. Size in relation to agile Lego-like organizations relates rather to the network they operate in, not to the physical and architectural manifestations of space.

Figure 3 shows the transition from hierarchy to a front-line focus. Figure 3 is an ideal model for a type of organization where hierarchical structures are replaced by a focus on the front line. It is also an ideal model for a unit within the "Lego logic" universe. Lego logic involves the dispersal of the Lego-like parts of an organization in the global economy based on an extreme focus on costs, quality, expertise and innovation.

**Figure 3: Agile organizations where the dominant logic is “Lego-rationality”**

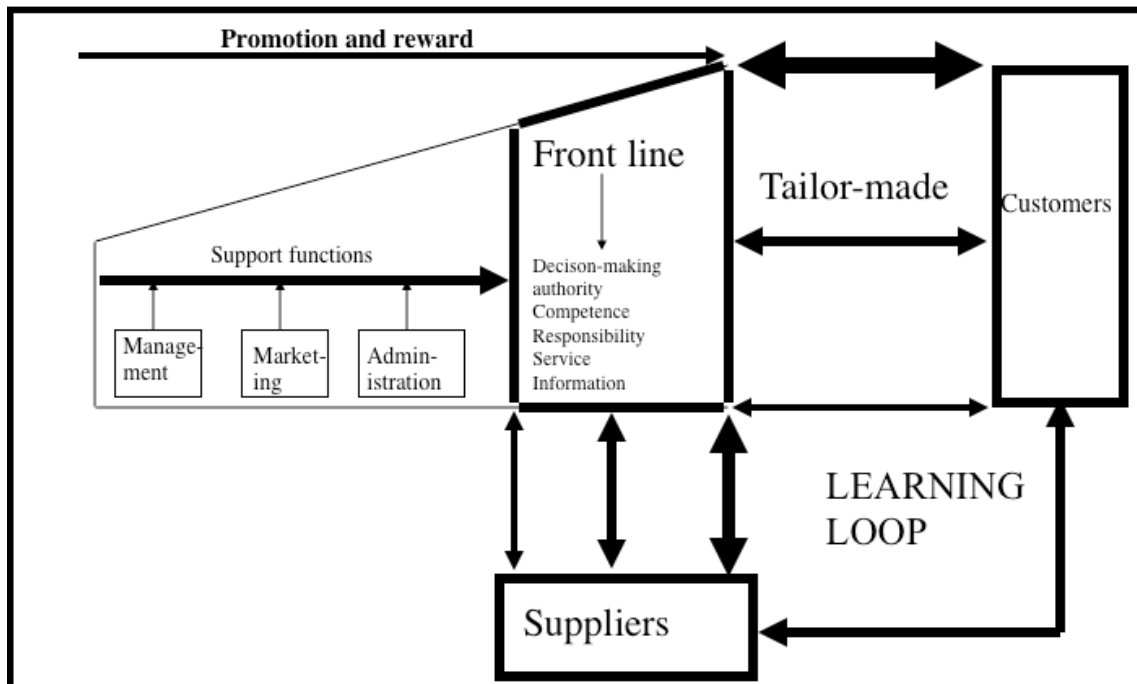

**New value creation processes**

New technology enables us to produce, communicate, organize, distribute and consume in different ways than before, resulting in new forms of cooperation. The results of this process include the growth of new ways of working and new forms of management. Future networks will probably be intelligent network-connected systems. We call these networks and their connecting computers “informat<sup>s</sup>”, which are a form of collective intelligence. We believe that this collective intelligence will provide the opportunity to bring social systems to a new level of organization, often termed the “systemic society” because it is interconnected at all levels.

Infrastructure relates to the transport of goods and energy, while the “info-structure”<sup>5</sup> relates to information, communication and knowledge processes. The development of the info-structure means that distance and borders are reduced, geographically, psychologically, culturally and socially. The development of the info-structure has a direct impact on transactions within and between organizations, and consequently affects the organization of activities within and between organizations.

The info-structure concerns the processes that enable the development, transfer, analysis, storage, coordination and management of data, information and knowledge. The info-structure consists of ten generic processes (see Miller, 1978)<sup>ii</sup>. It forms the basis of communication processes, and thus also the development of knowledge. The info-structure also greatly contributes to the establishment of new collaborative networks on a global scale. It is precisely the development of a new info-structure that enables new cooperation networks and new organizational and management forms to emerge, such as the focus on the front line and Lego-structured organizations. While a

<sup>5</sup> Information structure is abbreviated to info-structure in order to suggest an analogy to infrastructure.



developed infrastructure enables the transport of goods, services and energy, the development of the info-structure enables the coordination and integration of information resources on a global scale. Social interaction in the knowledge society develops through the new info-structure in the global space, for example through social networking and social media.

We ask the following hypothetical question: If production and distribution could be 100% automated, which organizations would grow? The answer would obviously be high-tech organizations, which could allow such automatization. Obviously, this is only a hypothetical case; nevertheless, the consequences of a development in this direction would be enormous for individuals, organizations and society. The economic, cultural, political and relational sub-systems would be greatly affected. High-tech value creation bears some similarity to the hypothetical case mentioned here.

High-tech value creation is the competitive response by companies in the West to the strategic challenge from low-cost countries. It is in this area that the West can compete with those countries with low labour costs and regulatory frameworks that reduce other costs.

In the hypothetical case above concerning automatization in an idealized organization, it is not the management of a company's employees that would be the key factor, but rather innovation, the organization of activities, the coordination of different functions internally in the company and with the outside world, and the integration of the knowledge processes that are used as inputs.

In such a world, management will be more a question of understanding interactive processes and creative actions. In interactive processes one neither controls nor is controlled. The handling of complexity and chaos grows in such a situation; indeed, these emerge as key dimensions for dealing with the processes that create products and services. Value creation, however, would be equally important in the idealized production model. The point is that value creation shifts more from value-chain thinking to other forms of value creation.

In today's globally competitive environment, such companies need leaders and employees with a focus on overall value creation processes. In practice, this means that organizations must employ, educate and cultivate people who focus on the dynamics that promote or impede value creation processes in organizations and for their customers. Value creation is understood here as something which is directly and indirectly connected to innovation, performance and results, which in turn are connected to the various goals that the company has set itself. In contrast, value creation in the industrial economy focused on economies of scale, logistics and organizational processes. Value creation processes in the knowledge economy are increasingly oriented towards knowledge development, transfer and integration, in which innovation is a crucial factor (Castells, 1996; Stehr, 1994). An important reason for this change is that while the industrial economy mainly focused on linear processes, such as the value chain, the focus of the knowledge economy aims at types of value creation processes beyond the value chain, such as value networks, workshops, communities and dialogues. These value creation processes are briefly described below.

In the academic literature on strategy there was a strong focus on the value chain in the 1980s and parts of the 1990s, especially through the position taken by Michael Porter in two of his works (Porter, 1980, 1985). These analyses of value chain thinking have focused on a linear and sequential understanding of value creation, for example consisting of inbound logistics, operations, outbound logistics, marketing and sales and service. At the level of industry, value chain thinking has been linked to a linear understanding related to the chain of supplier - customer - business. This approach has been increasingly criticized in recent years (e.g. Stabell and Fjellstad, 1998). The criticism was primarily aimed at the fact that value chain thinking is only suitable for describing and understanding traditional manufacturing companies; such criticism also objects that a linear interpretation is rarely valid. Consequently, there is now a stronger emphasis on prosumer (producer-consumer) systems (Toffler 1980), where suppliers, organizations and customers are viewed as a holistic system. However, different types of companies will have different levels of emphasis on different types of

## **ORGANIZING FOR PERMANENT WHITEWATER: WHAT MUST THE WEST DO IN ORDER TO COMPETE IN THE GLOBAL KNOWLEDGE ECONOMY?**

---

value creation processes, while all the relevant processes will be found (or should be) in most companies. This means that the value chain is still important, but other value creation processes must also be focused on. While the value chain within traditional manufacturing companies is primarily focused on the transformation of material resources, the focus for most organizations in the knowledge economy relates to information and knowledge. In a business world that is increasingly characterized by a Lego-like logic in relation to the value chain, information relating to the potential for outsourcing and in-sourcing is crucial. The value chain transforms this information to output consisting of components that can be assembled into solutions the customer has requested.

Within *the value network* there is a focus on communication and external relations. In the first instance this focus is on the customer, but also on suppliers, competitors, etc., and the values inherent in such connections. While the value chain itself focuses mainly on information, the value network focuses on communication. Like the value chain, the value network operates at the operational level. In order to create value for customers through communication, an important feature of the value network is the coordination and integration of information. Roughly speaking, one can say that the value network receives information about the elements of a potential solution from the value chain. This information is coordinated and integrated by the value network to provide value for the customer through customer solutions.

The *value workshop* operates at the management level and focuses on facilitating an efficient performance at operational level. First and foremost, this means ensuring that the operational level has access to resources, and an organization that contributes to the efficient utilization of these resources. This concerns both material and intangible resources, but particularly the latter, primarily competence development (knowledge, skills and attitudes). Put simply, it can be argued that the value workshop receives information from the operational level, value chain and value network, and ensures that they have access to the necessary resources to ensure efficient operation (i.e. a focus on productivity).

The *value dialogue* is primarily concerned with focusing attention on creativity, innovation, new ideas etc. Success in this requires a focus on both information and communication. The *value community* is based on an organization's need for dialogue with the outside world, reputation management and external legitimacy. This implies an emphasis on the value creation processes related to the values, norms and attitudes that are communicated externally. The value community is concerned with CSR (corporate social responsibility), the third bottom line, ethics etc.

The value creation processes described above are interactive or circular. To deal with such processes the organization needs to focus on human creativity, communication, expertise, social understanding and relationship management (see Drucker, 1999). Although we have made an analytical distinction between these different processes, in practice, they will often be interlinked, and in part performed by the same people or within a single team. For example, at the operational level the same individuals or teams could both collect and sort information in accordance with a value chain logic, while simultaneously coordinating and integrating this information within a value network logic.

All five value creation processes may be found in any organization. Some organizations, however, will place greater emphasis on one or several of the five value creation processes. All five value creation processes must be fostered if an organization is to be viable in the global knowledge economy. The guideline here is that organizations must have a greater degree of variation internally than externally, which is a simplified rewriting of "the law of requisite variety" (Ashby, 1961). We have illustrated the five value creation processes in Figure 4.

The five value creation processes may be summarized in the term high-tech value creation. High-tech value creation may be metaphorically understood as an emerging new continent. This new continent has been described by many authors, including Drucker, Bauman, Tofler, Sennett, Ohmae and Negroponte, to name just a few. Although they use different names to designate this emerging

new world, they are unanimous about one thing: What's emerging is truly emergent, in that it is something that has not existed before, even although some of what is new may resemble old wine in new bottles.

**Figure 4: The five value creation processes in the global knowledge economy**

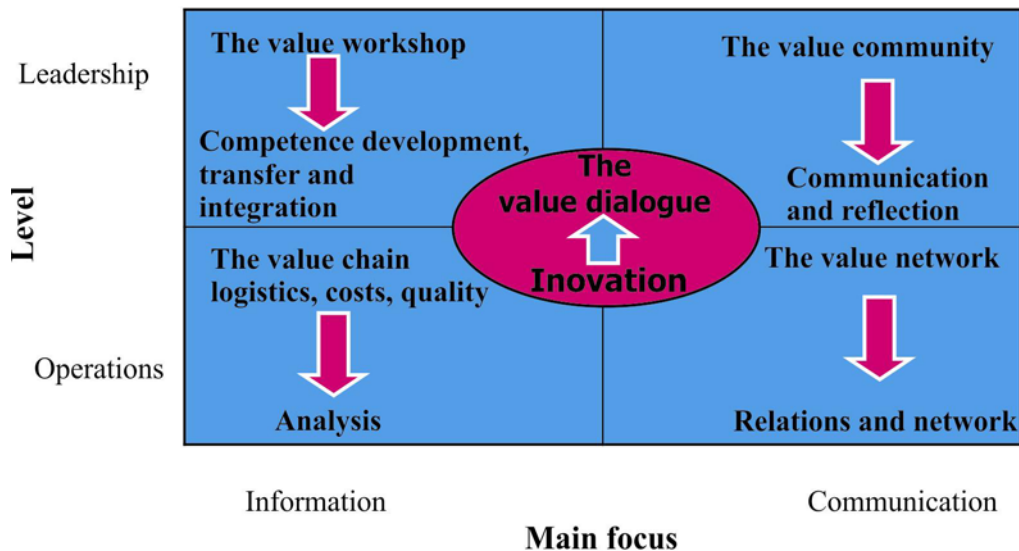

Those organizations that remain mired in old world ways of operating can only survive if they cut costs to the level of low-cost countries. In the new world, it is innovation that drives change and creates profits. Indeed, it is the price companies can demand before innovations are copied or imitated which provides the profits (or super profit) stemming from the creation of innovations. In the sphere of high-tech value creation it is continuous innovation that ensures value creation for individuals, organizations and society.

In the old world, everyone competes for survival. In the new world cooperation and competition are balanced in a completely different way. However, there are no permanent structures for cooperation; in some instances, there is cooperation, and at other times competition. At times alliances will be entered into, while at other times contracts will be competed for on the basis of other alliances and associations. At times, organizations will function as suppliers, at other times contractors, etc. To a large extent, high-tech value creation pushes beyond physical, mental and national boundaries, and the new world has no metropolis or visible centre.

The new world gets its raw materials and material supplies from the old world, similar to the way in which industrialized countries that received most of their raw materials from their colonies. However, the difference in this case is that those who supply the raw materials to the new world do not feel that they are “colonized”, because the new world is not a physical geographical entity, but an abstract one.

The old world has its physical boundaries, whereas the new world has no such physical boundaries. The new world is embedded in the old world, and goes beyond national boundaries. High-tech value creation is, on the other hand, a necessary condition for value creation in the old world.

## **ORGANIZING FOR PERMANENT WHITEWATER: WHAT MUST THE WEST DO IN ORDER TO COMPETE IN THE GLOBAL KNOWLEDGE ECONOMY?**

---

High-tech value creation is a necessary condition for survival in the global knowledge economy. In the new world the conditions for value creation have changed completely, because growth without innovation has become impossible in the global knowledge economy.

Financial, transportation and telecommunications technologies, and the software side of IT, promote the leveraging of global demographic differences, as well as the existing disequilibrium in the global cost structures. This promotes, in turn, economic growth in both low-cost and high-cost countries.

Utilization of global demographic differences and differences in global cost structures in turn accelerates globalization, just as industrialization spread from one area to another and equalized cost differences in the last century. Globalization and increased value creation eventually lead to changes in power structures, globally, nationally and at the level of the individual organization. The driving forces behind these changes are institutional and economic innovations<sup>6</sup>. The consequences of these innovations emerge, however, at all levels in the various social systems.

High-tech value creation results in just as much innovation within services, as it does in classic product-related innovation, because customers' needs, wishes and preferences will to a greater degree control value creation. For the individual organization, it will no longer suffice to think globally and act locally. Organizations will need to operate in the global space, in global co-creation teams connected to global competence clusters. These knowledge clusters are distributed all over the globe, and the co-creation teams must therefore operate virtually and link up to the various global centres of expertise. Local production clusters belong to the industrial society's mindset. Global competence clusters are developed in the knowledge economy. The new world also functions metaphorically regarding global competence clusters. It is in these global competence clusters that new innovations emerge in the knowledge economy.

### **The emergence of new innovations**

The question we try to answer here is: Where will future innovations emerge? If the relevance of our fundamental experiences collapses, we will experience problems when using the past in order to explain and understand what is going to happen in the future. Fortunately, we have adequately effective theories that provide us with insight into what may happen, such as Christensen's (1997) theory of disruptive innovations. Briefly stated, "disruptive innovations" involve "situations in which new organizations can use relatively simple, convenient, low-cost innovations to create growth and triumph over powerful incumbents" (Christensen et al., 2003: xv). This suggests that when costs are relatively high, it is reasonable to assume that low-cost innovations will occur. A direct analogy to this is that where real and relative quality decreases, the probability of emerging innovations increases.

To reveal how innovations will occur, Drucker (1994: 44) asks the following questions:

1. In which areas of economic life is the real and relative productivity in decline? The answer to the question gives an indication of where there will be major changes, because productivity is the measure of efficiency, and most of the social systems will seek to become more efficient in order to effectively use their resources.
2. Which new knowledge can be transformed into new technology to be used in a market to meet the needs, wishes and preferences of customers, users, patients, students, etc? The time lag between the development of new knowledge, the creation of new technology and the application of this technology in a market takes – on the basis of experience – somewhere

---

<sup>6</sup> Institutional innovations include the following types: political, social and cultural innovations. Economic innovations include the following types: organizational, material (technology, product, process, raw material), service and marketing.

between 20-40 years, notes Drucker (1994: 46). The bottom line for companies is to take advantage of the time-lag before the technology is introduced as an innovation in a market.

- How will the dispersal of innovations affect our market? The dispersal rate of innovation seems to have increased sharply in recent decades (op. cit.). Where the rate of diffusion of innovations increases, it is reasonable to assume that other types of innovations will occur. Among other things, this is because technological innovations in all probability will also foster both organizational and administrative innovations. New technological innovations will also lead to institutional innovations. Therefore it is important to know where and how quickly the increase in the dispersal rate of innovations will occur.

In Figure 5 we have illustrated where new innovations are most likely to emerge.

**Figure 5: The emergence of new innovations**

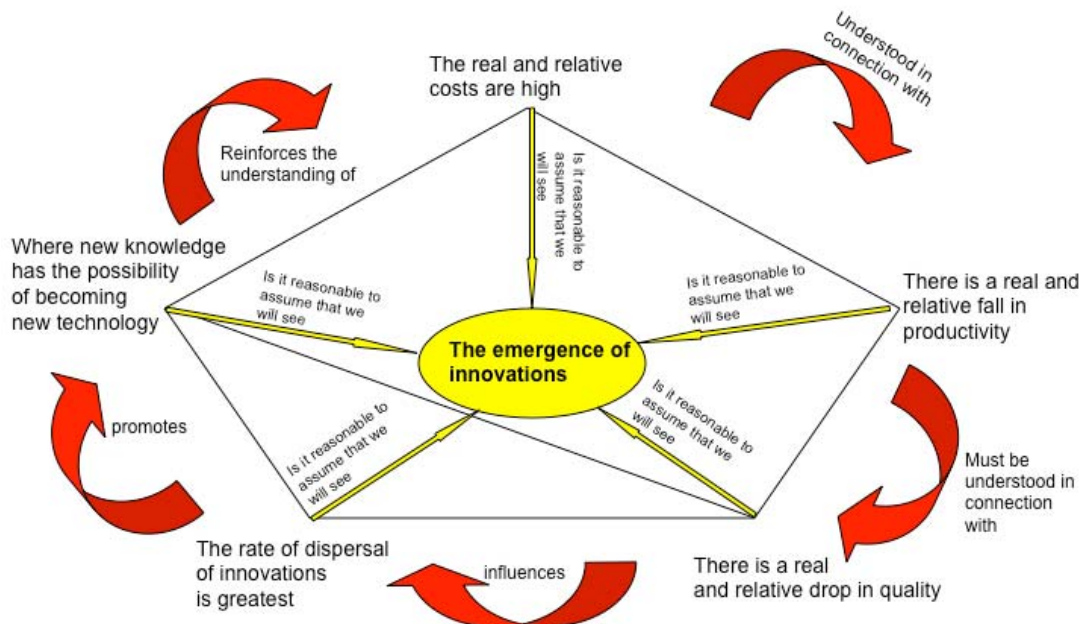

### Conclusion I: Practical implications

Put simply, it may be said that innovations evolve in three stages: idea generation, commercialization and realization. The realization phase is often the bottleneck in many projects, not the idea-generation and commercialization stages (see Andrew and Sirkin, 2006: 5). Andrew and Sirkin (2006: 7) term the realization phase “payback”; this is when the organization starts making money on the investments it made in the development of the innovation. The commercialization phase represents the first faltering steps into the market, which often does not reach much beyond the initial launch, rejection and loss.

The innovative leader should make sure to have as many ideas under development as grains of sand in the desert, in order to ensure that some of the ideas reach the market as innovations. The innovative leader should also reduce the time from idea to invoice, and increase the “payback” in the realization phase. The reason that many fail to come into the realization phase, say Andrew and Sirkin (2006: 8-9), is that they have not paid enough attention to the four S’s:

## **ORGANIZING FOR PERMANENT WHITEWATER: WHAT MUST THE WEST DO IN ORDER TO COMPETE IN THE GLOBAL KNOWLEDGE ECONOMY?**

---

1. “Start-up costs;
2. Speed to market;
3. Scale, or time to volume; [and]
4. Support costs, or postlaunch investment”.

Depending on which processes the organization has in place, the innovative leader may choose among four main types of models to bring innovations to the realization phase (see Andrew and Sirkin, 2006):

1. They make take control over the whole process, from idea generation to commercialization and realization.
2. They may take control over the whole process, but choose to employ different external actors in various parts of the process.
3. They may take control of idea generation and commercialization, but choose to license the realization phase.
4. They may choose an open solution for the whole process, involving customers, suppliers and academia.

The decision on the choice of model will depend on the organization’s capabilities, the product’s possibilities for rapid realization, and the market’s receptivity to innovation.

### **Conclusion II: Theoretical implications**

The scope of opportunities that open up at a time when the relevance of our fundamental experiences collapses may be formulated in the following question: How can we gain an understanding of future competitive challenges? Christensen and Raynor (2003) have shown that by applying innovation theories it is possible to indicate the scope of future innovations with some probability. This in itself is a theoretical innovation; previously, to a large degree innovation was thought of as something that happened by chance, and at best as a result of R & D investment. The pattern that Christensen and Raynor (2003) revealed, among other things, was that businesses that become established “experience a strong incentive to improve, acquire more customers and migrate into high-profit tiers of their market” (see Christensen et al., 2004: 29). The result of this drive in the market is that competition increases among new entrants to the market, and between the entrants and the established businesses. Our model in Figure 5 is a development of Christensen et al. (2004), and provides five clear indications of how the emergence of new innovations in the global knowledge economy will take place.

What is the basic driving force with regard to the emergence of innovations? Our answer is that the basic driving force is a shift in thinking. New mental models have emerged as a result of new opportunities provided by new technology. As a result of new ways of thinking and new technology, new business models have emerged. However, they have not emerged from any centre, for example, Tokyo, Silicon Valley, South Paris, the Milan region, etc. There is no centre, a Saint Peter’s Square, where one can go to in order to find the solution of the innovation puzzle. Nor is it the case that the periphery has replaced the centre as the driving force in the knowledge society. Indications in the knowledge society suggest that the center-periphery distinction is no longer viable, because geographic boundaries mean less, and the only thing that sets limits is our mental perception. The relative stability of technology seems to have disappeared. Innovations in every field have

become commonplace. Innovation has become a commonplace. The businesses that are unable to develop innovations, or cannot quickly absorb and adapt to new innovations, will be mangled by global competitive forces. This means that innovation leads to continuous and discontinuous changes at all levels and in all areas of society. There are no unaffected areas. As early as 1968, Drucker (1994: 9) called this development “techno-economic catastrophes”. However, this is disaster on par with Schumpeter’s creative destruction, where something must be destroyed in order for new life to flourish.

Metaphorically, it may be said that innovation leaders are like Minerva’s owls: they turn, combine and apply existing knowledge for a market. Classic entrepreneurs can metaphorically be regarded as the parrots of an economy – they fill gaps in the market with existing products and services. Innovators may be metaphorically considered to be an economy’s cuckoo chicks, who push aside what already exists. In this way the cuckoos represent creative destruction, which would not have existed if they had not been protected by those they would later come to harm.

### **References**

- Ackoff, R.L., Magidson, J. and H.J. Addison (2006). *Idealized Design*. New Jersey: Wharton School Publishing.
- Andrew, J.P. and H.L. Sirkin (2006). *Payback*. Boston: Harvard Business School Press.
- Ashby, W.R. (1961). *An Introduction to Cybernetics*. New York: Chapman & Hall LTD.
- Avgerou, C., Ciborra, C. and F. Land (2004). *The Social Study of Information and Communication Technology: Innovation, Actors, and Contexts*. Oxford: Oxford University Press.
- Bauman, Z. (1996). *Life in Fragments*. London: Polity Press.
- Bauman, Z. (2000). *Liquid Modernity*. Cambridge: Polity Press.
- Beck, U. (1992). *Risk Society: Towards a New Modernity*. London: Sage
- Beer, S. (1985). *Diagnosing the System for Organizing*. London: Wiley.
- Beer, S. (1994). *Beyond Dispute: The Invention of Team Syntegrity*. New York: John Wiley.
- Bennis, W. and W. Slatter (1968). *The Temporary Society*. San Francisco: Jossey-Bass.
- Bunge, M. (2003). *Emergence and Convergence: Quality, Novelty and the Unity of Knowledge*. Toronto: University of Toronto Press.
- Burrus, D. (1993). *Techno Trends*. New York: Harper Business.
- Castells, M. (1996). The informational economy and the new international division of labor: In *The New Global Economy in the Information Age* (Carnoy M. et al., eds.), Pennsylvania: The Pennsylvania State University Press,
- Christensen, C.M. (2010). *Disrupting Class, Expanded Edition: How Disruptive Innovation Will Change the Way the World Learns*. New York: MCGraw-Hill.
- Christensen, C.M. and M.E. Raynor (2003). *The Innovators’ Solution: Using Good Theory to Solve the Dilemmas of Growth*. Harvard: Business School Press.
- Christensen, et al., 2004
- Collins, J.C. (2001). *Good to Great: Why some Companies make the Leap and Others Don’t*, New York: Harper Business.
- Csikszentmihaly, M. (1978). Attention and the holistic approach to behavior, In: *The Stream of Consciousness* (Pope, K.S. and J.L.Singer, eds., New York: Plenum, 335-358.
- Drucker, P.F. (1993). *Post-Capitalist Society*. New York: Butterworth Heinemann.
- Drucker, P.F. (1994). *The Age of Discontinuity*. New York: Transaction Publishers.
- Drucker, P.F. (1999). Knowledge worker productivity: The biggest challenge, *California Management Review*, 41(2), 79-94.
- Drucker, (2007) (first published in 1985) *Entrepreneurship and Innovation*.
- Elbæk,U. (2003). *Kaospilot A-Z*. Gylling, Danmark: Narayana Press.

## ORGANIZING FOR PERMANENT WHITEWATER: WHAT MUST THE WEST DO IN ORDER TO COMPETE IN THE GLOBAL KNOWLEDGE ECONOMY?

---

- Goleman, D. (2006). *Social Intelligence*. New York: Hutchinson
- Gratton, L. (2007). *Hot Spot*. London: Prentice Hall.
- Hamel, G. (1998). Opinion: Strategy innovation and the quest for value. *MIT Sloan Management Review*, 39(2), 8.
- Hamel, G. (2000). *Leading the Revolution*. Boston: Harvard Business School Press.
- Hargadon, A. (2003). *How Breakthroughs Happen*. Boston: Harvard Business School Press.
- Herbst, K. (2002). Enabling the poor to build housing: Cemex combines profit and social development. *Changemakers Journal*, Sept/Oct.
- Hock, D. (1999). *Birth of the Chaordic Age*. San Francisco: Berrett-Koehler Publishers. Inc.
- Johannessen, J-A. and B. Olsen (2009). *Strategi og organisering for fremtidens virksomhet*. Bergen: Fagbokforlaget.
- Johannessen, J-A. (1997). Aspects of causal processes. *Kybernetes*, 26(1), 30-52.
- Johannessen, J-A., Olaisen, J. and B. Olsen (2006). *Positivt lederskap*. Bergen: Fagbokforlaget.
- Kim, W.C. and R. Mauborgne (1993). Value innovation: The strategic logic of high growth. *Harvard Business Review*, 75, 102-112.
- Kim, W.C. and R. Mauborgne (2005). *Blue Ocean Strategy*. Boston: Harvard Business School Press.
- Koselleck, R. (2002). *The Practice of Conceptual History*. Stanford: Stanford University Press.
- Lash, C. (1979). *The Culture of Narcissism*. New York: W.W. Norton.
- Luhman, (1995). *Social Systems*.
- McGrath, R.M. and I. MacMillan. (2000). *The Entrepreneurial Mind*. Boston: Harvard Business School Press.
- Minzberg, H. (2003). *The Strategy Process*. New York: Financial Times Management.
- Morgan, J.M. and J.K. Liker (2006). *The Toyota Product Development System*. New York: Productivity Press
- Porter, M.E. (1980). *Competitive Strategy*. New York: The Free Press.
- Porter, M.E. (1985). *Competitive Advantage*. New York: The Free Press.
- Porter, M. E. (1990). *The Competitive Advantage of Nations*. New York: The Free Press.
- Porter, M.E. (1996). What is Strategy. *Harvard Business Review*, 74/Nov. Dec.
- Porter, M. E. (2004). Chapters 2, 3, 4, 5 and 6: In *Unique Value: Competition Based on Innovation Creating Unique Value* (Weller, C.D., ed.) Ashland OH: Innovation Press, LLC Publisher, 25-187.
- Prahalad, C.K. and G. Hamel (1990). The Core Competence of the Corporation, *Harvard Business Review*, 68(3), 79-91.
- Prigogine, I. (1997). *The End of Certainty*, New York: Free Press.
- Schumpeter (kreative destruksjoner)
- Sennet, R. (1998). *The Corrosion of Character*. New York: Norton.
- Sennett, R. (2004). *Respect*. New York: Norton.
- Sennett, R. (2006). *The Culture of the New Capitalism*. London: Yale University Press.
- Stabell, C.B. and Ø.B. Fjeldstad (1998). Configuring value for competitive advantage: on chains, shops, and networks. *Strategic Management Journal*, 19, 413-437.
- Stehr, N. (1994). *Knowledge Societies*. London: Sage.
- Stewart, (1997+1999)
- Stalk, G. and R. Lachenauer (2004). *Hardball: Are you Playing to Play or Playing to Win?* Boston: Harvard Business School Press.
- Thackara, J. (2003). Collaboration: In *Kaospilot A-Z* (Elbæk, ed.), Narayana Press, Gylling, 148-149.
- Thomas, W.I. and F. Znaniecki (1918). *The Polish Peasant in Europe and America*. Chicago: University of Chicago Press.
- Thurow, L. (1999). *Creating Wealth*, London: Nicolas Boealey.
- Toffler, A. (1980). *The third wave*. New York: William Morrow.



- <sup>i</sup> Informats are part of a holistic understanding of technology, in which technology is defined as: “the scientific study of the artificial” (Bunge, 1985: 231). In this context, artefacts are the research of technology. The development of artefacts “largely determines the history of mankind” (see Gehlen, 1980: 20). Artefacts are cultural products (see Mitcham, 1994; Ihde, 1990). On a deeper level, technological advances facilitate physical and mental processes, i.e. “the tendency toward facilitation” (Gehlen, 1980: 18). Gehlen’s (1980) classification of technology is: instruments, machines and automats; we add “informat” to Gehlen’s classification. The distinction between automats and informats is in line with Zuboff’s (1988) argument that computers make it possible to both automate production and to use them in the information process to increase performance goals. In the following we define the four concepts: instrument, machine, automat and informat. Instrument: “Any object which can transform, applicate or transmit muscular energy to matter and perform work” (Gehlen, 1980:8); for instance, screwdriver, pick, shovel, hammer, etc. Machine: Any object which is capable of transforming energy into movement (se Gehlen, 1980:8); for example, water wheel, steam engine, car, plane etc. Automat: may be divided into two categories: A) “Symbol controlling devices” (Gehlen, 1980). The focus is here is on observation and coordination; for instance, thermostats, electronic measuring instruments, etc. B) “symbol manipulating and transformation devices” (Gehlen, 1980: 8); for instance, computers. Informat: Symbol transferring and symbolic connecting units. The focus here is on the structural links in a network. With regard to informats, the intelligence lies in the connective structures of the network, not in the individual nodes of the network; for instance, telephone, fax, television, e-mail, future multimedia systems, future integrated intelligent systems, etc. The human brain provides an analogy for an informat. The neurons and groups of neurons develop a network, which develop a mental model of a situation. This network consists of groups of neurons, in which each group represents a critical part of the whole. When all the groups are linked, a cognitive model manifests itself in its entirety. The individual nodes have little significance before they are connected in an overall structural network. This is our analogous representation of an informat. In other words, informats and “info-structure” are closely related concepts. Informats are artefacts that enable the info-structure to function. We stress here that informats are basically in an evolutionary stage. However, we assume that the logic of information, communications and networks will result in social systems developing informats to a greater degree, because this logic requires structural links. Informats connect and coordinate knowledge and mobilize expertise where it is available, dependent on the logic of quality, expertise and costs. Collective knowledge structures can therefore be developed through interactions in the global space. Informats, “info-structure” and communication crystallize in the free knowledge space, which analogously may be compared to how the free market was originally crystallized through infrastructure and trade. However, the free knowledge space is not synonymous with zero costs. On the contrary, information and knowledge is not free and will always have a cost, because it costs to develop the codes we use to understand, explain and apply information and knowledge.
- <sup>ii</sup> Information control, information channels and networks for communication, information collection, information analysis, information strategy, information structuring and systematization, information coordination, information storage and recovery, information culture and information transmission. The ten processes of the “info-structure” may be considered as nodes in a network at different system levels, which together maintain the totality of the info-structure. The purpose of the nodes is to coordinate information in the social systems and networks of social systems, so that social interaction is possible, and new knowledge can be developed. Each of these processes is of strategic importance to the social systems. The control of one or more of these processes results in guiding principles for the control of information, communication and network logic of social systems. Through control of the individual processes one has the opportunity to influence activities in other processes. The various processes have their relative importance in the various systems. At the same time, they are of different importance depending on the system level that is being focused on in the social systems.



# ORGANIZATIONAL PERFORMANCE – THE IMPACT OF MANAGERIAL POTENTIAL AND INNOVATION

Aziz Šunje<sup>1</sup>

Muamer Bezdrob<sup>2</sup>

Emir Kurtić<sup>3</sup>

**Abstract:** *The purpose of this research is to design and test an organizational performance model that reflects the relationship between managerial potential, structural and production innovation and organizational performance. Along with a thorough literature review, all necessary hypotheses that make up a basis for a theoretical model were formulated. Consequently, the corresponding model was specified. For the purposes of model testing a questionnaire was sent to more than 300 companies in the F B&H, yielding 158 valid responses. These data, along with data from the corresponding balance reports were used to test both the measurement and structural models. Research results show that the managerial proficiency have a direct and positive impact on the structural and production innovation, which, subsequently, has a direct and positive impact on the organizational performance. The main implication of this research is that it provides another proof of the existence of positive relationship between innovations and performance.*

**Keywords:** *performance, performance measurement, innovation, managerial proficiency*

## Introduction

Performance is the single most important indicator of the soundness of any business organization. Whether it is measured only by dumb, short-sighted financial parameters or by sophisticated multidimensional measurement methods, performance always points toward two crucial attributes of a business organization – effectiveness and efficiency (Neely *et al.* 2005). This is tightly related to the most fundamental act of management – the undertaking of appropriate moves in the present, in order to achieve desired business outcomes in the future (Lebas and Euske 2007). Being so, one of the primary goals of any proficient manager is to improve the performance of her/his organization.

Even though it can-not be generalized, there are many studies showing a strong positive relation between innovation and organizational performance (Klomp and van Leeuwen 2001), meaning that innovations, if dealt with effectively, represent a factor that would most likely enhance organizational performance (Herring and Galagan 2011). Furthermore, innovation is widely considered as a critical source of organizational competitive advantage (Crossan and Apaydin 2010). However, scarce organizational resources prevent managers to invest in all available or feasible innovations, but force them to find and pursue an optimal set of innovations (Stock and Zacharias 2011).

Combining the two previous arguments, it could be implied that, in general, innovations would produce necessary preconditions for performance improvement, but only with a proper (innovation) management would they lead towards a higher organizational performance. Such interdependence between innovations, innovation management and organizational performance is particularly interesting for our research.

---

<sup>1</sup> School of Economics and Business, University of Sarajevo

<sup>2</sup> PING d.o.o. Sarajevo, mbezdrob@ping.ba

<sup>3</sup> School of Economics and Business, University of Sarajevo

There were a huge number of studies conducted on the topic of performance (Neely 2007) and innovation (Crossan and Apaydin 2010). Many of these studies are related to performance outcomes from innovations (Huang *et al.* 2011), to the performance of innovation (Katila 2007) or to the innovation management in general (Christensen 1997). On the other hand, this study explores the cause-and-effect chain of mutual relationships between the managerial potential, level of innovativeness and organizational performance on the company level. Thus, the main research question of this study is:

*RQ: What are the mutual relationships between managerial potential (proficiency), innovativeness and organizational performance on the organization level?*

An empirical analysis of the impact that innovation could have on organizational performance is rather difficult, so the studies that deal with such analyses are quite rare. In line with such a status, this study contributes to the body of literature on interdependence between innovation, innovation management and organizational performance.

In this study we wanted to design an overall theoretical model of organizational performance, founded on the existing literature, which reflects the relationship between managerial potential (proficiency), structural and production innovation and organizational performance. The proposed model had to be designed in such a way that it could be applied to any market conditions and particularly to those of the Federation of Bosnia and Herzegovina.

### **Literature Review**

It is a given fact that innovation and organizational performance are, individually, amongst the most extensively explored notions and concepts. However, even though there are numerous studies on the relationship between those two terms (e.g. Neely & Hii 1998), it could be said that this is a still rather unexplored field, because of the lack of empirical studies that relate to this issue.

Still, some important findings have emerged from these studies and research activities, which could be used as the foundation for the present and future research on the relationship between innovation (management) and organizational performance.

### **Organizational Performance and Innovation – The relationship**

Through the development of organization's capabilities and their conformance to the environment, innovation leads to the strengthening of the creative advantage and obtaining supreme performance (Hurley & Hult 1998). According to Cooper and Kleinschmidt (1987), the ability to innovate is the most important characteristic that determines the performance of a company.

As Eshlaghy and Maatofi (2011) put it, innovation has a positive and significant effect on the performance of (small) firms. Generally speaking, with a high ability to innovate, an organization will be enabled to use and support new ideas and processes, which may lead to the new products, services or technologies. Furthermore, by coordinating organization with environmental changes, innovation enables small firms to develop a competitive advantage and acquire supreme performance (Eshlaghy & Maatofi 2011).

Choi, Jang, and Hyun (2009) have given a systematized review of some aspects of the research on the relationship between innovation and firm performance (Table 1). As the authors noted, the research aspects given in the Table 1 are the ones conducted after Schumpeter's "The theory of economic development", published in 1934, in which he positioned innovation as a key factor in

analyzing the performance of firms. Since then, “... *innovation has been considered as a core factor in the analysis of performance, especially in business strategy research. (2009: 1722)*” (Choi *et al.* 2009).

In this context, these authors have classified four research groups, depending on the nature of relationship between innovation and performance (direct or indirect), and whether some variables (moderating or mediating) exist or not.

Group 1 (e.g. Geroski 1994), as classified by Choi *et al.* (2009), argued that there is a direct relationship between innovation and firm performance, stating that innovation directly leads to better performance.

**Table 1. Relationship between innovation and firm performance**

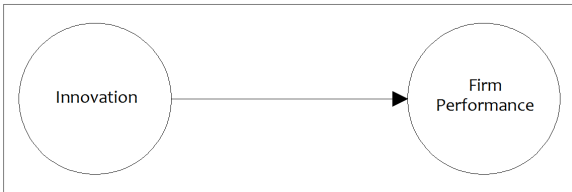
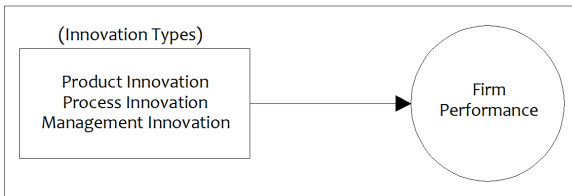
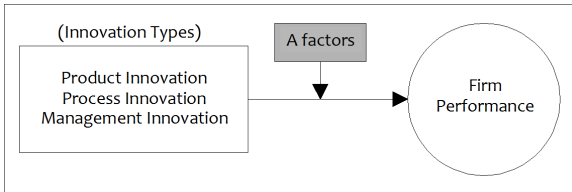
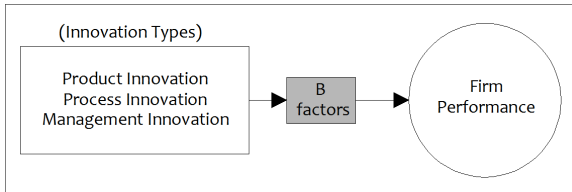
Research	References
<b>Group 1. Direct relationship between innovation and firm performance</b>	
	<i>Geroski 1994</i> <i>Acs &amp; Audretsch 1988</i> <i>Simonetti 1994</i>
<b>Group 2. Direct relationship between innovation types and firm performance</b>	
	<i>Evan 1966</i> <i>Kimberly 1981</i> <i>Abrahamson 1991</i> <i>Rogers &amp; Schoemaker 1971</i>
<b>Group 3. Direct relationship between innovation and firm performance with moderating variable(s)</b>	
	<i>Parthasarthy &amp; Hammond 2002</i> <i>Bisbe and Otley 2004</i>
<b>Group 4. Indirect relationship between innovation and firm performance through mediating variable(s)</b>	
	<i>Neely &amp; Hii 1998</i> <i>Zott 2003</i> <i>Kim 2004</i>

Source: Adapted from Choi, Jang, and Hyun (2009)

## **ORGANIZATIONAL PERFORMANCE – THE IMPACT OF MANAGERIAL POTENTIAL AND INNOVATION**

---

Group 2 (e.g. Evan 1966) also argued that there is a direct relationship between innovation and firm performance, but instead of the overall innovation, specific innovation types should be considered. Therefore, good performance is a result of a specific innovation type, not just an overall innovation.

Group 3 (e.g. Parthasarthy & Hammond 2002) is another group which argued that there is a direct relationship between innovation and firm performance, only this time moderating variable(s) or factor(s) have to be taken into account. Examples of these factors are the innovation processes itself, or the organization structure and organization environment.

Group 4 (e.g. Zott 2003), according to the classification made by Choi *et al.* (2009), is a group which argued that there is an indirect relationship between innovation and firm performance, as mediating variable(s) or factor(s) are important catalysts for this relationship to come to life. Examples of these factors are ability, operation routine, actions and aptness.

To conclude, innovation ability is the most important determinant of organizational performance, which was confirmed by many studies (Damanpour 1991; Matsuno *et al.* 2002; Hult *et al.* 2004; Collins & Moschler 2008). All of them indicate the existence of a positive relationship between innovation and organizational performance. Thus, the nature and strength of this relationship, as well as the type of innovation and possible moderating/mediating variables are therefore very interesting research topics.

Additionally, an understanding of how innovations are created inside the organizations and distributed to users is a starting point for understanding how to increase organizational performance (Collins & Moschler 2008). Therefore, how innovations and innovative process are being managed, or simply innovation management, is a crucial question to be answered.

### **1.1. ORGANIZATIONAL PERFORMANCE AND INNOVATION – THE MODEL**

The central issue of this study is the relationship between innovation and organizational performance. Many studies that are related to this matter show a conceptual contribution that innovation can make to organizational performance, but it is much more difficult to empirically demonstrate this relationship (Tidd 2001). Furthermore, the most important roles in the innovation process are played by the people who carry out all innovative actions and managers who are responsible for the creation of innovative culture and environment (Crossan & Apaydin 2010). Because of these facts, we have focused our research effort on building a theoretical model which would comprise an effect chain between the managerial potential, innovativeness and performance of organizations.

Many research studies analyze and confirm a direct and positive link between the educational level of employees and innovations (Kimberly & Evanisco 1981). It must be noted that this refers not only to managers, but to all employees (Camelo-Ordaz *et al.* 2006). Thus, we propose our first hypothesis as:

*H1: The organization's management proficiency has a direct and positive impact on the production and structural innovation.*

Under the term “management proficiency” we imply management team diversity (Vaccaro *et al.*, 2009), management (organizational) learning system (formal and experience-based learning system) as well as management expert foundation. It relates to the overall management expertise, existing and potential, that the organization possess.

As it was previously mentioned, a general stand between scholars is that innovativeness provides a critical source of company's competitiveness (e.g. Cooper & Kleinschmidt 1987). In line with that, there are a number of studies that confirm a positive relationship between innovativeness and organizational performance (e.g. Huang *et al.* 2011). Thus, according to all of these findings, the following hypothesis imposes itself:

*H2: The production and structural innovations have a direct and positive impact on organizational performances.*

These two hypotheses determine our theoretical (conceptual) model of innovation (management) impact on organizational performance.

### **Data and Methodology**

To test the hypothesized model we have conducted a survey among the companies registered in the Federation of Bosnia and Herzegovina. The questionnaire was sent to 310 companies that are randomly chosen from the whole population of the companies that fit the following profile:

- employing at least 20 people,
- established in 2002 or earlier,
- not belonging to financial, health care, social welfare, educational or public sector.

Along with this survey, we have conducted an archival research of financial reports from the companies that took part in survey.

We have received 186 responses (58.1%) out of which 158 were valid (49.38%). The responding companies have the average size of 173.5 (S.D. 358.7) employees and the average age of 16.5 (S.D. 4) years in business. The estimated population of the companies that fit the described profile is 1500, so the expected statistical error is around 8% with the confidence level of 95%. The companies are proportionally distributed among different industries and different geographical parts of the F B&H.

### **Measures**

All variables in the model were measured using the data from the conducted survey, from the official balance reports of the corresponding companies and from the Statistical Yearbook of the Federation of Bosnia and Herzegovina. The measurement spans a five-year period, from the year 2006 to the year 2010.

Since we pursued information as objectively as possible, we have consciously made a trade-off between the quality of information (Kenett & Shmueli 2009) and the technical quality of data (i.e. ordinal measurement scale and non-normality). We have designed survey questions accordingly, and we had to transform those continual variables into an ordinal form, because using variables with different measurement scales traditionally creates a problem with multivariate statistical techniques (Schumacker & Lomax 2010).

### **Management Proficiency (F<sub>1</sub>)**

To measure this construct we have adapted and combined measures from Vaccaro et al. (2009) and Mol and Birkinshaw (2009). This construct is related to the managerial potential that company has both within its management team and non-managerial staff. We used a four-indicator measure for this construct:

- “*Management Heterogeneity*” ( $X_1$ ) – ranks (1-6) companies based on the number of top-managers and their experience in different functional areas, controlled by the size of the company (determined by the number of employees).
- “*Managerial Skills Improvement*” ( $X_2$ ) – ranks companies based on whether they employed external management consultants (3), organized specialist training for their managers (2) or both (4).
- “*Expert Foundation*” ( $X_3$ ) – ranks (1-7) companies based on the ratio of employees with a graduate level to the total number of employees.
- “*Education System*” ( $X_4$ ) – ranks (1-9) companies based on their training plans and educational budget.

### **Production & Structural Innovation (F<sub>2</sub>)**

To measure this construct we used a very simple three-indicator measure which refers to the level of innovative activities within the companies’ production systems and structures. Those three indicators are:

- “*New Processes*” ( $Y_1$ ) – ranks companies based on whether they introduced new production processes (3), modified old production processes (2) or both (4).
- “*New Products/Services*” ( $Y_2$ ) – ranks companies based on whether they introduced new products (3), modified old products (2) or both (4).
- “*Organizational Changes*” ( $Y_3$ ) – ranks companies based on whether they introduced a new managerial structure (3), made changes to the existing managerial structure (2) or both (4).

### **Organizational Performance (F<sub>3</sub>)**

To measure this construct, measures from previous research on performance measurement were adapted (Bezdrob & Bićo Čar 2012). This measure is completely based on the balanced scorecard principles (Kaplan & Norton 1992, 1996), where we wanted to find a single measure that would represent each of the four perspectives of an organization’s performance. The indicators for this measure are:

- “*Labor productivity change*” ( $Y_4$ ) – calculated as:

$$Y_4 = \frac{\left( \frac{\text{Sales}}{\text{Number of employees}} \right)_{2010} - \left( \frac{\text{Sales}}{\text{Number of employees}} \right)_{2006}}{\left( \frac{\text{Sales}}{\text{Number of employees}} \right)_{2006}}$$



- “Number of employees change” ( $Y_5$ ) – calculated as:

$$Y_5 = \frac{(\text{No. of employees})_{2010} - (\text{No. of employees})_{2006}}{(\text{No. of employees})_{2006}}$$

- “Market share change” ( $Y_6$ ) – calculated as:

$$Y_6 = \frac{\left(\frac{\text{Sales}}{\text{Industry sales}}\right)_{2010} - \left(\frac{\text{Sales}}{\text{Industry sales}}\right)_{2006}}{\left(\frac{\text{Sales}}{\text{Industry sales}}\right)_{2006}}$$

- “EVA change” ( $Y_7$ ) – calculated as:

$$EVA = (r - c) \times K$$

$$r = \frac{\text{Net profit}}{\text{Equity} + \text{Longterm liabilities}}$$

$$c = \frac{\text{Equity} \times 5\% + \text{Longterm Financial liabilities} \times 6\% \times (1 - 10\%)}{\text{Equity} + \text{Longterm Financial liabilities}}$$

$$K = \text{Equity} + \text{Longterm liabilities}$$

$$Y_7 = \frac{EVA_{2010} - EVA_{2006}}{|EVA_{2006}|}$$

Variables  $Y_4$  to  $Y_7$  are originally continual, but after the computation of corresponding values they were transformed into appropriate ordinal variables.

Even though EVA is not completely applicable to the observed companies, this approximation was used because EVA is considered as one of the most valuable measures of organizational financial performance (Copeland et al. 2000; Otley 2007).

## Results

Table 2 contains the means and standard deviations of and covariance between all model variables, where alternative parameterization is used for the underlying variables of model’s ordinal variables (Jöreskog 2004).

To test the hypothesized model we employed structural equation modeling (SEM) because it enables a concurrent testing of several dependence relationships within a single theoretical model (Hair et. al 2009). Following the two-step approach (Anderson & Gerbing 1988) we used LISREL 8.80 for both measurement model testing and structural model testing.

## Assumptions

The assumptions were evaluated through SPSS and LISREL. The dataset contains responses from 158 companies. There were no missing data and no univariate outliers. Considering that the hypothesized model has only three constructs, each with at least three indicators, this sample size is adequate for the model estimation (Hair et al. 2009).

Since we dealt with ordinal data, both univariate and multivariate normality were violated. All variables showed a moderate non-normality ( $skew < 2$ ,  $kurtosis < 7$ ) except variable  $Y_4$  ( $skew > 2$ ). Thus, in accordance with the recommendation for dealing with non-normal and ordinal data (Finney &

**ORGANIZATIONAL PERFORMANCE – THE IMPACT OF MANAGERIAL POTENTIAL AND INNOVATION**

DiStefano 2006), the Satorra-Bentler scaling method for  $\chi^2$  and standard errors is used for model estimation.

**Table 2. Means, Standard Deviations and Covariance between Model Variables**

	<b>Variable</b>	<b>Mean</b>	<b>S.D.</b>	<b>1</b>	<b>2</b>	<b>3</b>	<b>4</b>	<b>5</b>
1	Management Heterogeneity	2.741	2.091	4.370				
2	Managerial Skills Improvement	0.887	2.375	2.000	5.642			
3	Expert Foundation	0.297	1.089	0.503	0.897	1.187		
4	Education System	2.536	3.216	1.383	3.693	1.386	10.345	
5	New Processes	1.555	1.360	-0.016	0.810	0.245	1.482	1.851
6	New Products/Services	1.901	1.534	0.194	0.937	0.319	0.742	1.475
7	Organizational Changes	1.180	1.886	0.627	1.486	0.416	1.759	1.316
8	Labor productivity change	-0.180	5.682	0.880	2.509	0.726	1.792	0.665
9	Number of employees change	1.265	0.743	0.047	0.149	0.087	0.505	0.172
10	Market share change	1.728	1.281	0.401	0.860	0.163	0.999	0.316
11	EVA change	-1.329	20.929	3.462	7.233	0.721	13.707	7.133

**Table 2. Means, Standard Deviations and Covariance between Model Variables (Cont'd)**

	<b>Variable</b>	<b>6</b>	<b>7</b>	<b>8</b>	<b>9</b>	<b>10</b>	<b>11</b>
6	New Products/Services	2.352					
7	Organizational Changes	0.984	3.558				
8	Labor productivity change	0.874	1.156	32.286			
9	Number of employees change	0.124	0.279	-1.508	0.552		
10	Market share change	0.231	0.443	3.602	0.504	1.64	
11	EVA change	6.102	9.514	56.324	2.411	12.208	438.019

N = 158

**Measurement Model**

Since a poor fit was found for initial measurement model, we did a post hoc model modification in order to develop a better fitting model. Based on modification indices and theoretical relevance, covariances between the error terms of  $Y_2$  and  $Y_3$  and error terms of  $Y_4$  and  $Y_5$  was added to model specification. This final measurement model is shown in Figure 1.

There are 27 parameters in the measurement model that should be estimated, and the total number of variance and covariance terms is 66. Because 66 is greater than 27 (39 degrees of freedom) the model is properly identified and model testing could be performed.

The fitting of the final measurement model is examined through several goodness-of-fit indices (Table 3). All these absolute, incremental and parsimony fit indices suggest an acceptable fit for the measurement model.

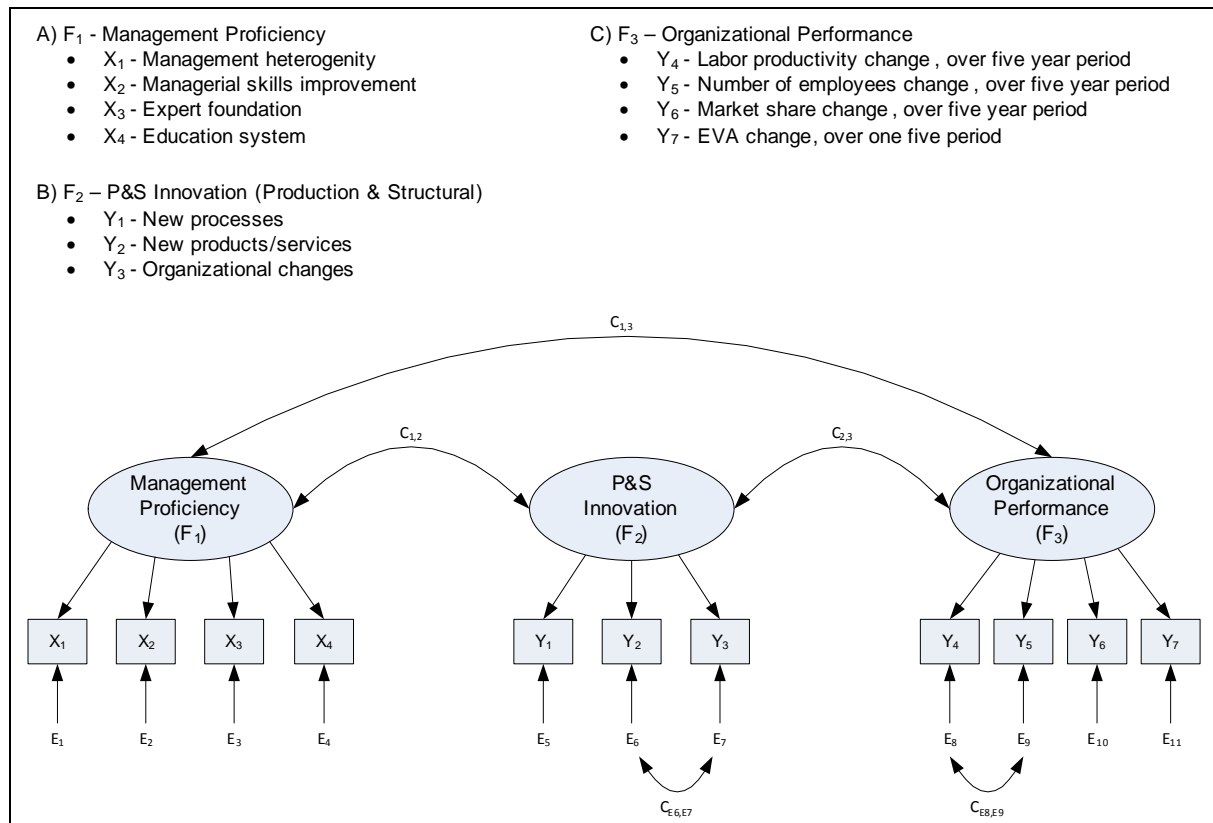

**Figure 1. Measurement model of innovation (management) impact on organizational performance**

A considerable model improvement is confirmed with significant Satorra-Bentler difference  $\chi^2$  statistics:  $\Delta\chi^2 = 33.081$  with two degrees of freedom ( $p < 0.001$ ).

Construct validity is assessed through convergent validity, discriminant validity and nomological validity. All factor loading estimates are of expected direction and all are statistically significant as required for convergent validity.

**Table 3. Goodness-of-Fit Measures of Structural and Measurement Model (Final)**

GoF Index	GoF Guideline	Structural Model	Measurement Model
$\chi^2$ (df); p-value	$p > 0.05$	45.188 (40); $p = 0.264$	41.893 (39); $p = 0.346$
RMSEA	RMSEA < 0.08	0.0287	0.0217
90% CI of RMSEA	%	0.0 – 0.0643	0.0 – 0.0609
SRMR	SRMR < 0.08	0.0780	0.0620
CFI	CFI > 0.95	0.991	0.995
AGFI	%	0.851	0.856

For construct validity, an individual standardized factor loading cutoff value is 0.5 and preferably 0.7 (Hair *et al.* 2009). Table 4 displays the standardized factor loadings for the measurement model. It could be seen from Table 4 that factor  $F_1$  has one loading that fall below the

## ORGANIZATIONAL PERFORMANCE – THE IMPACT OF MANAGERIAL POTENTIAL AND INNOVATION

cutoff value. Consequently, it is a candidate for removal from the model, but since it has strong support in theory we decided to leave it within the model. All in all, the estimates of the average variance extracted (*AVE*) all exceed the value of 0.25, while the construct reliability (*CR*) estimates are all well above 0.6, which are acceptable levels for these two parameters (Hair *et al.* 2009). Combining these results with a fact that the overall model fits very well, we concluded that convergent validity for the model was provided.

**Table 4. Standardized Factor Loadings, Average Variance Extracted, Reliability Estimates**

	F <sub>1</sub>		F <sub>2</sub>		F <sub>3</sub>	
(“Management Heterogeneity”) – X <sub>1</sub>	0.43	(0.44)				
(“Managerial Skills Improvement”) – X <sub>2</sub>	0.75	(0.78)				
(“Expert Foundation”) – X <sub>3</sub>	0.52	(0.51)				
(“Education System”) – X <sub>4</sub>	0.65	(0.63)				
(“New Processes”) – Y <sub>1</sub>			0.80	(0.80)		
(“New Products/Services”) – Y <sub>2</sub>			0.86	(0.85)		
(“Organizational Changes”) – Y <sub>3</sub>			0.68	(0.68)		
(“Labor Productivity Change”) – Y <sub>4</sub>					0.60	(0.61)
(“Number of Employees Change”) – Y <sub>5</sub>					0.57	(0.58)
(“Market Share Change”) – Y <sub>6</sub>					0.87	(0.86)
(“EVA Change”) – Y <sub>7</sub>					0.54	(0.53)
Average Variance Extracted ( <i>AVE</i> )	36.0%	(36.5%)	61.4%	(60.8%)	43.3%	(43.2%)
Construct Reliability ( <i>CR</i> )	0.68	(0.69)	0.83	(0.82)	0.75	(0.75)

*Note:* Values in parenthesis are standardized factor loadings, *AVE* and *CR* from the structural model.

All *AVE* estimates for the model’s constructs are greater than the squared inter-construct correlations, which indicate that there are no problems with discriminant validity. Besides, there are no cross-loadings among either indicators or error terms, so these results tell us that the discriminant validity is provided, too.

Nomological validity is supported by a fact that all correlations between constructs are positive just as it was predicted, and all inter-construct correlations are statistically significant.

Since there was only one standardized residual greater than |4.0| and the modification indices point only to the addition of covariance between error terms of indicators, we have concluded that there is no need for further model modification.

### Structural Model

The second stage in this two-step approach is the structural model (Figure 2) testing, which consists of the structural model specification and the assessment of structural model validity. Model specification, which implies proposing hypotheses and establishing structural relationships, was described above. Structural model validity assumes an assessment of the overall model fit and the examination of model diagnostics (Hair *et al.* 2009).

Structural model fitting is examined through the same goodness-of-fit indices as for measurement model (Table 3). Again, all these fit indices suggest that the structural model provides a very good overall fit.

A cross-examination of the standardized factor loadings from both the structural and the measurement models showed that loadings are almost identical (Table 4), which represents evidence of indicators stability.

The final step in structural model validation is the examination of structural path estimates (Table 5). It could be seen that all structural path estimates are statistically significant and in the predicted direction. Given that all estimates are in compliance with the proposed hypotheses, these results provide strong support for our theoretical model.

Table 5. Structural Path Estimates

Structural Relationship	Unstandardized Parameter Estimate	Standard Error	t-value	Standardized Parameter Estimate
H1: $F_1 \rightarrow F_2$	1.04	0.28	3.65	0.44
H2: $F_2 \rightarrow F_3$	0.23	0.10	2.32	0.27

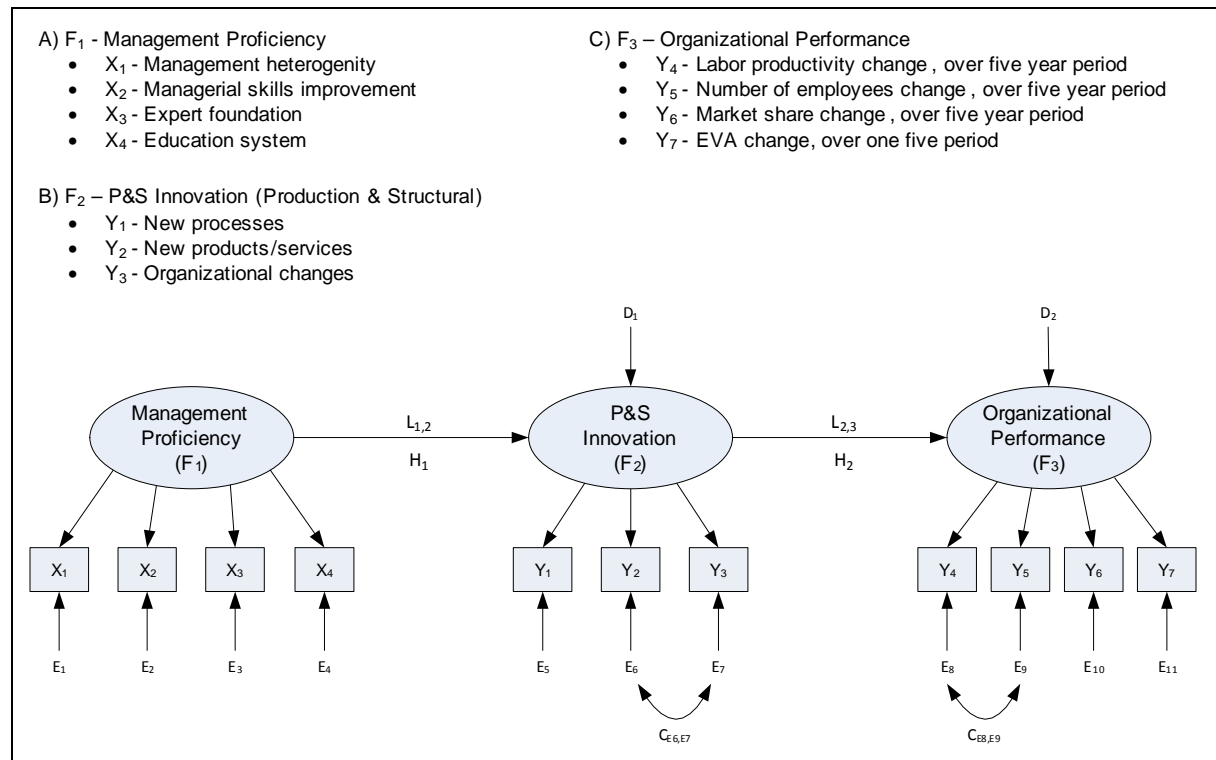

Figure 2. Structural model of innovation (management) impact on organizational performance

The chi-square difference between the two models is  $\Delta\chi^2 = 3.295$ , with one degree of freedom ( $p > 0.05$ ). Insignificant chi-square difference indicates that the model fit could not be improved by estimating another structural path.

There was only one standardized residual greater than  $|4.0|$  and modification indices point only to the addition of covariance between error terms of indicators, so the conclusion is the same as for the measurement model – there is no need for any model re-specification.

### Discussion

The results obtained by testing both the measurement model (Figure 1) and structural model (Figure 2) indicate an excellent fit between the theoretical model and real world represented with the data sample. The observed absolute and incremental goodness-of-fit indices (Table 3) confirm that the model imposed covariance matrix ( $\Sigma$ ) is similar to the data sample covariance matrix ( $S$ ). Such outcome points to overall empirical model validity, meaning that the measurement validity of all proposed constructs was fully confirmed.

Two more indicators of the results' quality should be reported here – statistical power and effect size. Statistical power for this model amounts to  $(1 - \beta) = 0.62$  at  $\alpha = 0.05$ , which falls short of the commonly acceptable level of 0.8.

Regarding the effect size, the model explains 19.7% of the variance in the  $F_2$  construct, which represents a medium effect. Likewise, the model explains 7.4% of the variance in the  $F_3$  construct, which represents a small effect. The main reason for such a small effect is that all indicators of  $F_3$  construct measure changes, and it is much harder to predict flows than states in the models like this one.

These results indicate a low explanatory value of the model, meaning that the model explains rather small amount of variance in endogenous constructs and that notably bigger part refers to error variance.

Finally, the most important part of model testing is model's structural path analysis (Table 5). The structural paths represents proposed hypotheses and, as it could be seen from Table 5, all of them are statistically significant and in expected directions. Practically, this means that all proposed hypotheses are confirmed, which results from an inter-constructs direct effects analysis:

1. The level of structural and production innovation is predicted with managerial proficiency ( $L_{1,2} = 0.44$ ;  $p < 0.001$ ), which confirms hypothesis H1.
2. Improvement in organizational performance is predicted with increase in the level of structural and production innovation ( $L_{2,3} = 0.27$ ;  $p < 0.05$ ), which confirms hypothesis H2.

The strong support to all proposed hypotheses suggests that the cause-and-effect chain of mutual relationships between the managerial potential, level of innovativeness and organizational performance really exists on the company level. In other words, the successful validation of the proposed model implies that companies with a managerial potential sufficient for proper innovation management will achieve a higher organizational performance.

In addition, the analysis of indirect effects results shows that higher managerial proficiency has a positive impact on the level of structural and production innovation which, subsequently, has a positive impact on organizational performance improvement ( $L_{1,3} = L_{1,2} \times L_{2,3} = 0,12$ ;  $p < 0,05$ ).

This result provides some additional insights into the theory that is built within the model. Namely, the model indirectly points to a positive impact of managerial potential on company's performances. Literature research reveals a number of studies that point to such conclusions (Gu 2003; Huang *et al.* 2011; Stock & Zacharias 2011), which further confirms validity of the proposed theoretical model.

## **Conclusion**

In this study we wanted to empirically test the impact that innovation (management) has on organizational performance on the company level under the conditions of immature and underdeveloped markets. Therefore, relying strongly on the existing knowledge base, we focused our efforts on the design of a theoretical model of innovation management impact on organizational performance that could be used under the market conditions of the Federation of Bosnia and Herzegovina (F B&H).

Our analysis has shown that all proposed hypotheses are supported, and that the designed theoretical model is valid and applicable. Accordingly, it was found that the managerial proficiency has a direct and positive effect on the level of structural and production innovation, which subsequently, has a positive effect on organizational performance.

Finally, despite the low explanatory value of the model, the most important result of this study is that it empirically proves the positive relationship between (sound management of) innovation and organizational performance.

## **Limitations and Suggestions for Future Research**

There are a few limitations that apply to this research. First, in order to keep the model simple we have used only a limited set of observed variables and, as a consequence, we had a smaller portion of constructors' variance explained. Future research could seek to improve the measures we used in our model to enhance an explanatory value of the model.

Second, all collected data, which were used for the analysis, come from one country only. Therefore, the obtained results could be generalized only for the population from which the sample was drawn. In order to generalize these results outside the context of the F B&H, other data samples, which would represent a broader population, must be used.

Due to a small sample size, no validation of the model was done, either with multiple samples or with a single sample randomly split into two or more subsamples (Schumacker & Lomax 2010). Other studies may further improve the model and test its validity by applying it to a different dataset.

## **Implications of the Research**

We have designed a very simple theoretical model of organizational performance that could be applied in any economic surroundings. What is more important, our model could be used as a basis for further development and improvement of the understanding of interdependence between innovations, innovation management and organizational performance.

This research and its results contribute to the body of knowledge related to innovation management and performance measurement and management by designing an applicable model with corresponding constructs and individual indicator items, i.e. by designing measurement scales and types that could be used for future research.

## **References**

Abrahamson, E. (1991). Management Fad and Fashions: The Diffusion and Rejection of Innovations. *Academy of Management Review*, 16(3): 586-612.

## ORGANIZATIONAL PERFORMANCE – THE IMPACT OF MANAGERIAL POTENTIAL AND INNOVATION

---

- Acs, Z.J., Audretsch, D.B. (1988). Innovation in Large and Small Firms: An Empirical Analysis. *American Economic Review*, 78(4): 678-690.
- Anderson, J.C., Gerbing, D.W. (1988). Structural Equation Modeling in Practice: A Review and Recommended Two-Step Approach. *Psychological Bulletin*, 103(3): 411-423.
- Bezdrob, M., & Bičo Čar, M. (2012, June). Performance Measurement Model – Developing And Testing A Measurement Model Based On The Simplified Balanced Scorecard Method. *University of Zagreb, 6th International Conference "An Enterprise Odyssey", Šibenik, 13<sup>th</sup>-16<sup>th</sup> June 2012*.
- Bisbe, J, Otlej, D. (2004). The Effects of the Interactive Use of Management Control Systems on Product Innovation. *Accounting, Organizations & Society*, 29(8): 709-737.
- Camelo-Ordaz, C., de la Luz, F-A.M., Salustiano, M-F. (2006). Influence of Top Management Team Vision and Work Team Characteristics on Innovation. *European Journal of Innovation Management*, 9(2): 179-201.
- Choi, S., Jang, H., Hyun, J. (2009). Correlation between innovation and performance of construction firms. *Canadian Journal of Civil Engineering*, 36(11): 1722-1732.
- Christensen, C.M. (1997). *The Innovators Dilemma*. Boston: Harvard Business School Press.
- Collins, J.H., Moschler, J. (2008). The Life Cycle of Innovations. *Defense AR Journal*, 15(1): 74-84.
- Cooper, R.G., Kleinschmidt, E.J. (1987). New products: What separates winners from losers?. *Journal of Product Innovation Management*, 4(3): 169–184.
- Copeland, T., Koller, T., Murrin, J. (2000). *Valuation - Measuring and Managing the Value of Companies*. 3<sup>rd</sup> Edition, New York: John Willey & Sons.
- Crossan, M.M., Apaydin, M. (2010). A Multi-Dimensional Framework of Organizational Innovation: A Systematic Review of the Literature. *Journal of Management Studies*, 47(6): 1154-1191.
- Damanpour, F. (1991). Organizational Innovation: A Meta-Analysis of Effects of Determinants and Moderators. *Academy of Management Journal*, 34(3): 555-590.
- Damanpour, F., Schneider, M. (2009). Characteristics of Innovation and Innovation Adoption in Public Organizations: Assessing the Role of Managers. *Journal of Public Administration Research & Theory*, 19(3): 495-522.
- Eshlaghy, A.T., Maatofi, A. (2011). Learning Orientation, Innovation and Performance: Evidence from Small-Sized Business Firms in Iran. *European Journal of Social Sciences*, 19(1): 114-122.
- Evan, W.M. (1966). Organizational Lag. *Human Organization*, 25(1): 51-53.
- Finney, S.J., DiStefano, C. (2006). Non-normal and Categorical Data in Structural Equation Modeling. In Hancock, G.R., Mueller, R.O. (Eds), *Structural Equation Modeling: A Second Course*. Charlotte: Information Age Publishing, 269-314.
- Geroski, P. (1994). *Market Structure, Corporate Performance, and Innovative Activity*. Oxford: Clarendon Press.
- Gu, A.Y. (2003). State Ownership, Firm Size, and IPO Performance: Evidence form Chinese "A" Share Issues. *American Business Review*, 21(2): 101-108.
- Hair, J.F., Black, W.C., Babin, B.J., Anderson, R.E. (2009). *Multivariate Data Analysis*. 7<sup>th</sup> Edition, Upper Saddle River: Prentice Hall.
- Herring, S., Galagan, P. (2011). Why Innovation? Why Now? *T+D*, 65(9): 26-28.
- Huang, L., Chen, S.K., Han, S.B. (2011). The Effects of Business Reorganization and Technical Innovation on Firm Performance. *Journal of Business & Economic Studies*, 17(1): 29-36.
- Joreskog, K.G. (2004). Structural Equation Modeling with Ordinal Variables Using LISREL, Scientific Software International.
- Available at: <http://www.ssicentral.com/lisrel/techdocs/ordinal.pdf>.
- Accessed 19 December 2011.
- Hurley, R.F., Hult, T.M. (1998). Innovation, Market Orientation, and Organizational Learning: An Integration and Empirical Examination. *Journal of Marketing*, 62(3): 42-54.
- Kaplan, R.S., Norton, D.P. (1992). The Balanced Scorecard—Measures that Drive Performance. *Harvard Business Review*, 70(1/2): 71-79.
- Kaplan, R.S., Norton, D.P. (1996). *The Balanced Scorecard: Translating Strategy into Action*. Boston: Harvard Business Press.
- Katila, R. (2007). Measuring Innovation Performance. In Neely, A. (eds) *Business Performance Measurement: Unifying Theory and Integrating Practice*. (2<sup>nd</sup> Edn). Cambridge: Cambridge University Press, 304-317.
- Kenett, R.S., Shmueli, G. (2009). On Information Quality. *University of Mariland*.
- Available at: <http://ssrn.com/abstract=1464444>Working.
- Accessed 19 December 2011.



- Kim, I.H. (2004). The Synthesis Model of Value Creation: New Horizon for Dynamic Management View. *Strategic Management Society 24th Annual International Conference*, San Juan, Puerto Rico, October 31-November 3 2004.
- Kimberly, J.R. (1981). Managerial Innovation. In P.C. Nystrom & W.H. Starbuck (Eds.), *Handbook of organizational design, Volume 1: Adapting Organizations to their Environments*, Oxford: Oxford University Press.
- Kimberly, J.R., Evanisko, M.J. (1981). Organizational Innovation: The Influence of Individual, Organizational and Contextual Factors on Hospital Adoption of Technologies and Administrative Innovations. *Academy of Management Journal*, 24(4): 689-713.
- Klomp, L., van Leeuwen, G. (2001). Linking Innovation and Firm Performance: A New Approach. *International Journal of the Economics of Business*, 8(3): 343-364.
- Lebas, M., Euske, K. (2007). A Conceptual and Operational Delineation of Performance. In Neely, A. (eds) *Business Performance Measurement: Unifying Theory and Integrating Practice*. (2<sup>nd</sup> Edn). Cambridge: Cambridge University Press, 125-139.
- Matsuno, K., Mentzer, J.T., Özsomer, A. (2002). The Effects of Entrepreneurial Proclivity and Market Orientation on Business Performance. *Journal of Marketing*, 66(3): 18-32.
- Mol, M.J., Birkinshaw, J. (2009). The Sources of Management Innovation: When Firms Introduce New Management Practices. *Journal of Business Research*, 62(12): 1269-1280.
- Neely, A. (2007). *Business Performance Measurement: Unifying Theory and Integrating Practice*. (2<sup>nd</sup> Edn). Cambridge: Cambridge University Press.
- Neely, A., Gregory, M., Platts, K. (2005). Performance Measurement System Design: A Literature Review and Research Agenda. *International Journal of Operations & Production Management*. 25(12): 1228-1263.
- Neely, A., Hii, J. (1998). "Innovation and Business Performance: A Literature Review", *The Judge Institute of Management Studies, University of Cambridge*,  
Available at: [http://ecsocman.hse.ru/data/696/521/1221/litreview\\_innov1.pdf](http://ecsocman.hse.ru/data/696/521/1221/litreview_innov1.pdf).  
Accessed 14 August 2012.
- Otley, D. (2007). Accounting Performance Measurement: A Review of its Purposes and Practices. In Neely, A. (Ed), *Business Performance Measurement: Unifying Theory and Integrating Practice*. 2<sup>nd</sup> Edition, Cambridge: Cambridge University Press, 11-35.
- Parthasarthy, R., Hammond, J. (2002). Product Innovation Input and Outcome: Moderating Effects of the Innovation Process. *Journal of Engineering & Technology Management*, 19(1): 75-91.
- Rogers, E.M., Shoemaker, F.F. (1971). *Communication of Innovations: A Cross-Cultural Approach*. New York: Free Press.
- Schumacker, R.E., Lomax, R.G. (2010). *A Beginner's Guide to Structural Equation Modeling*. 3<sup>rd</sup> Ed. New York: Routledge.
- Simonetti, J.A. (1994). Impoverishment and Nestedness in Caviomorph Assemblages. *Journal of Mammalogy*, 75(4): 979-984.
- Stock, R.M., Zacharias, N.A. (2011). Patterns and Performance Outcomes of Innovation Orientation, *Journal of the Academy of Marketing Science*, 39(6): 870-888.
- Tidd, J. (2001). Innovation Management in Context: Environment, Organization and Performance. *International Journal of Management Reviews*, 3(3): 169-183.
- Vaccaro, I.G., Jansen, J.J.P., Van Den Bosch, F.A.J., Volberda, H.W. (2009). Management Innovation: Uncovering the Influence of Top Management Teams. *Copenhagen Business School Management Innovation Conference*.  
Available at: <http://www.cbs.dk/en/layout/set/print/content/download/115700/1564763/file/Management%20Innovation%20-%20Uncovering%20The%20Influence%20Of%20Top%20Management%20Teams.pdf>.  
Accessed 19 December 2011.
- Zott, C. (2000). Dynamic Capabilities and the Emergence of Intra-industry Differential Firm Performance: Insights From a Simulation Study. *Department of Entrepreneurship, INSEAD*.  
Available at: <http://home.business.utah.edu/mgtwh/WSC/zott.pdf>.  
Accessed 14 August 2012.



# THE IMPACT OF ORGANIZATIONAL CULTURE ON MOTIVATION

Nebojša Janićijević<sup>1</sup>

**Abstract:** *This paper explores how different types of organizational culture impact the possibility of satisfying different needs and motives of the members of an organization. By over viewing motivation content theories, three basic groups of needs and motives which drive the members of an organization have been identified. Also, based on classification known as Competing Values Framework, the basic types or kinds of organizational culture have been described. Then, possible influences of each of the organizational culture types on each group of needs and motives have been analyzed. It has been observed that each of the organizational culture types represents a suitable ambience for satisfying one group of needs, but at the same time it inhibits satisfying the other two groups of needs of the people in organizations.*

**Keywords:** *motivation, organizational culture, organization*

## Introduction

The assumption of organizational culture's impact on motivation of the members of an organization has been present in the literature for a long time, but it is relatively poorly theoretically developed and empirically tested (Mahal, 2009). In order to explain the organizational culture impact on motivation, it is necessary to answer two questions. First, how does culture impact motivation, i.e. what is the mechanism of this influence? Second, in which direction does culture impact motivation, i.e. how do particular types of organizational culture influence the motivation of employees? While the first question has relatively been explored, both theoretically and empirically, the second question has largely been neglected.

With respect to mechanism of organizational culture's impact on motivation, the existing researches show that it is a social identification caused by the need of people for belongingness and relatedness (Alvesson, 2002; Martin, 2002; Brown, 1998). Namely, all major motivation theories show that people as social being have a strong need to belong to some social group or community. They have the need to feel accepted, loved and appreciated by some social group. Still, people do not wish to feel accepted by just any group, but by the group which they can identify with. By belonging to such a group, people build a part of their identity on the identity of that group. Organizational culture is, according to numerous authors, precisely the basis of identity of a social group in which it develops. A strong organizational culture with clearly expressed values, which the members of an organization accept and hold on to in everyday behavior, creates a clear identity of that organization with which the existing members, as well as the potential members, can identify with. The culture of an organization must be strong in order for people to have something to belong to. If an organization has no identity, i.e. if its culture is weak, then it will not be able to satisfy the need of people for belongingness, because people will not perceive it as a separate social community which one can belong to and with which one can identify with. Hence, a strong organizational culture provides the conditions for satisfying the need for belongingness of its members. The stronger a culture, the easier it is for the people to identify with and relate to the organization, and thereby to satisfy their need for belongingness. When the members of an organization feel accepted by the collective of organization which they identify with, they will be motivated to put in more effort to achieve the organizational goals, they will work harder and have a greater work performance. However, in order for people to identify with organization, satisfy the need for belongingness and be motivated, it is not enough for

---

<sup>1</sup> Faculty of Economics, University of Belgrade, jnebojsa@eunet.rs

## **THE IMPACT OF ORGANIZATIONAL CULTURE ON MOTIVATION**

---

organization to just have a strong organizational culture with prominent and clear values, but it is also necessary for it to have congruence of these values and individual, personal values of the members of an organization (O'Reilly, Chatman, Caldwell, 1991). A strong organizational culture with values opposite from personal values of an individual will not enable identification and relating of the individual with the organization, but just the opposite: a potential member of organization will not even enter it, and the existing member will have a strong desire to leave it. This means that culture can be not only a motivator, but also a demotivator, if there is no compatibility between individual values and organizational culture values.

The second question related to organizational culture impact on motivation, which deals with the direction of this influence, is almost entirely neglected in the literature. This question, however, is very significant for both researchers as well as for practicing managers. Namely, it would be very useful to know what needs and motives of employees are supported by and what are inhibited by specific types or kinds of organizational culture. The direction of organizational culture' impact on motivation is observed in stimulative or destimulative impact of certain types of organizational culture on individual needs and motives of the members of an organization. The assumption is that organizational cultures with different values and norms have different implications on satisfying various kinds of needs and motives of employees. In other words, different types of organizational culture create different context for manifesting and satisfying different needs and motives. Members of an organization, as we will see in the overview of theories, are motivated by different needs. The fact is, however, that these needs and motives have different significance for different people. Some people will primarily be motivated by material needs and rewards, while others will wish to satisfy the need for belongingness, and again others will be directed solely on satisfying the need for achievement and growth. Compatibility of organizational culture type and the dominant motive of some member of organization will lead to his/her better motivation and higher work performance. Organizational culture creates context which stimulates and facilitates satisfying some needs and motives, while it destimulates and makes it difficult to satisfy other needs and motives of the members of an organization. It is important to know which needs and motives of the members of an organization are stimulated, and which are destimulated by particular type of organizational culture, since it leads to a higher degree of motivation of the members of an organization. Hence, the main question to be answered is: what are the implications of different types of organizational culture on satisfying different needs and motives of employees? In order to answer this question, different types of organizational culture, as well as different needs and motives of employees must first be identified. Then, it is necessary to determine, both theoretically and empirically, which types of organizational culture are suitable for satisfying specific needs and motives of employees. This paper represents the first step towards it. It contains theoretical elaboration of the assumption on the directions of organizational culture's impact on motivation. Thus, it will result in hypotheses through which causal relationships between organizational culture types and needs or motives of employees are operationalized and concretized. It will then be possible to empirically test these hypotheses.

The structure of this paper is adjusted to its goal. First, the needs and motives classification will be presented which emerges from the major motivation content theories. Then, organizational culture will be presented and its types will be identified by accepting some of the widely known classifications in the literature. In the last segment of the paper, hypotheses will be developed about causal relationships between organizational cultures types and the needs and motives of employees.

### **Motivation**

Motivation has always been an important topic in management, whereby work motivation, i.e. motivation of people to work in organizations has always been explored in the area of management.

The significance of motivation arises from the fact that it determines the amount of effort that the members of an organization will put in achieving of the organizational goals, and thereby also their work performance and organizational performance as well. Numerous motivation theories are well-known in the literature on management. They explain what motivates people to work and how does this process of motivation develop. So far, several key contributions have emerged in the literature in revealing of this issue: Maslow's Hierarchy Of Needs, Alderfer's ERG Model, Herzberg's Two-Factor Theory (also known as Herzberg's Motivation-Hygiene Theory and Dual-Factor Theory), and McClelland's Theory of Needs (also referred to as The Three Need Theory).

Maslow discovered that people in organizations are driven by five groups of needs which are hierarchically arranged (Maslow, 1943). These five groups of needs are: physiological needs, safety needs, love or belongingness needs, esteem needs and self-actualization needs. Maslow later grouped the five stated needs into two groups: *Basic Needs*, which include physiological and safety needs, and *Growth Needs*, which include belongingness, esteem and self-actualization needs. The hierarchical arrangement of these needs means that there is an order for their satisfying. This, practically, means that the needs of "higher" order cannot be satisfied until the needs of "lower" order, i.e. the needs closer to the base of the hierarchical pyramid, are satisfied.

Alderfer's model of needs, also called ERG Model, introduces a more flexible approach to explaining the relationships between certain types of needs (Alderfer, 1972). This author claims that people in organizations are driven by three types of needs: *Existence needs*, *Relatedness needs*, and *Growth needs*. Existence needs correspond to Maslow's basic needs; relatedness needs correspond to Maslow's belongingness and love needs, while growth needs refer to desire of people to learn new things, improve their abilities, participate in interesting and challenging jobs, and achieve results. There is no hierarchical relationship among these needs. Alderfer even claims that certain factors, such as cultural ambience or personal history, can largely influence that an individual significantly favors some at the expense of other needs.

Herzberg's Two-Factor Theory states that motivation of employees is regulated by two groups of factors: Hygiene factors and Motivators (Herzberg, 1968). The essence of his contribution is that he discovered that different factors determine satisfaction and dissatisfaction of employees at workplace. Hygiene factors determine the presence or absence of dissatisfaction, while motivators determine the presence or absence of satisfaction. Thus, according to him, if a person has a high salary (hygiene factor), it does not necessarily mean that this person is satisfied, but only that he/she is not dissatisfied. If the job is not challenging (motivator), it does not mean that an employee will be dissatisfied, but only that he/she will not be satisfied. In the group of hygiene factors Hertzberg included mostly extrinsic factors, such as salary, working conditions, business policy, company organization, relations with the superior officers, and the like. In the group of motivators Hertzberg mostly included intrinsic factors, such as: challenging work, possibility for learning and personal growth, job advancement, recognition, and the like. Hertzberg argued that managers can by means of hygiene factors motivate employees to put in effort only to a certain limit, i.e. that all the creative energy and potential of the employees cannot be fully exploited by exclusive reliance on these factors. In order for managers to fully exploit all energy and potential of the employees, they must motivate them by the use of motivators.

McClelland (McClelland, 1966) also differentiated three types of needs that people satisfy in organizations. These are: *need for affiliation*, *need for achievement*, and *need for power*. Need for affiliation is also identified in other motivation theories, while need for achievement is very similar to self-actualization needs and growth needs. What is new in McClelland's theory is the *need for power*.

There is an obvious similarity between these four theories of needs and motives stimulating people to work in organizations which can best be observed in the following figure:

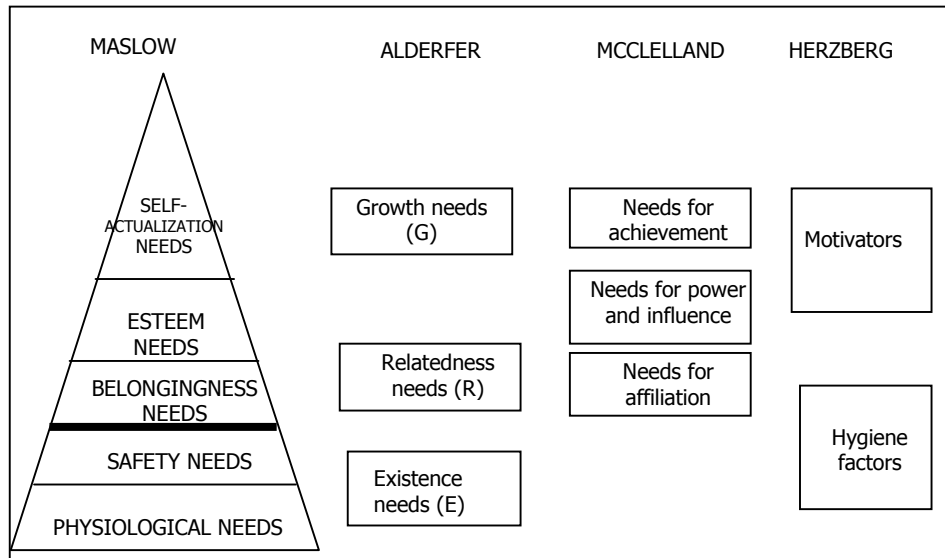

**Figure 1: Motivation theories comparison.**

Source: Janićijević N. (2010) Organizaciono ponašanje, Beograd: Data status, pp. 128.

For the purpose of further research of organizational culture's impact on motivation, it is necessary to make a synthesis of contributions of all the described motivation content theories. This synthesis would enable us to identify the basic needs and motives which are influenced by different types of organizational culture. The overview of motivation theories shows that four basic groups of need which drive people in organizations can be distinguished: physiological needs, safety needs, belongingness needs, and growth needs. Belongingness or relatedness needs are present in every motivation content theory. People as social beings have the need to be members of some social group, but also to be accepted by this group as its equal members. This need is also the reason why the strength of culture, by means of identification, impacts the level of motivation of the members of an organization, as previously explained. Also, all theories of motivation agree that employees in organizations undoubtedly have the need for growth, achievement and self-actualization as well. People have the need to learn new things, to personally grow and live up to their full potentials, and to advance in an organization. Beside physiological needs in Maslow's theory and as a part of existence needs, in Alderfer's theory, safety needs are also present. People in organizations have the need to be safe not only physically, but also psychologically and socially. They have the need to be safe from being fired, harassed, or in some other way brought in situation in which they would not be able to satisfy their basic interests and rights. Finally, physiological or basic material needs are also recognized in almost all theories of motivation. People satisfy these basic needs mainly through earnings and other forms of rewards in organizations. Even though physiological needs are very important to employees, they are not included in our analysis since we do not see how organizational culture can influence their fulfillment. So, in the following analysis we will focus on the impact of organizational culture on satisfying safety needs, needs for belonging and growth needs.

## Organizational culture

Organizational culture can be defined as a “system of assumptions, values, norms and attitudes manifested through symbols which the members of an organization have developed and adopted through shared experience and which help them determine the meaning of the world around them and how to behave in it” (Janićijević, 2011). As it may be observed from the definition, organizational culture has cognitive and symbolic component in its content. Cognitive component comprises of mutual assumptions, values, norms, and attitudes that the members of an organization share and that shape their mental (interpretative) schemes. In this way organizational culture determines the way in which the members of an organization perceive and interpret the world around them, but also the way to behave in it. Organizational culture’s cognitive content enables the members of an organization to uniquely assign meanings to occurrences within and outside of the organization and to uniquely react to them. Hence, if a strong organizational culture exists in an organization, all the members of an organization will similarly and predictably make decisions, take actions and enter interactions. Symbols are visible part of organizational culture which manifest its cognitive component. Semantic, behavioral and material symbols strengthen, convey, but also change organizational culture (Dandridge, Mitroff, Joyce, 1980).

In order to explore the direction in which organizational culture impacts motivation of employees, it is necessary to identify the types or kinds of organizational culture. Thus, we will be able to determine which types of organizational culture favor satisfying of previously identified needs and motives. For this purpose, we will use the existing several classifications of organizational cultures present in the literature. One of the major and most often used organizational culture types’ classifications in the literature is called Competing Values Framework (Cameron, Quinn, 2006). In this classification, organizational cultures are differentiated according to two basic criteria: 1. flexibility, changes, dynamicism vs. stability, order, predictability; 2. internal orientation, integration, harmony vs. external orientation, differentiation, competition. Based on these two dimensions of organizational culture, a matrix of four fields containing four different types of cultures can be constructed. Quinn and Cameron constructed the matrix shown in the Figure below, which recognizes the following organizational culture types: clan culture, hierarchy culture, market culture and adhocracy culture.

*Clan Culture.* In this type of organizational culture, the metaphor for organization is an extended family or clan. Organization is a very friendly place for its members and resembles an extended family. The leader of organization is considered a head of the family, but also a mentor. Tradition, commitment and loyalty hold people together. A long-term commitment to human resources development is emphasized, and a great importance is ascribed to cohesion and work ethics. Success is defined based on customer satisfaction and the very employees’ satisfaction. Organization is oriented towards support and highly values teamwork, consensus and participation, care for people and individual growth. The importance of commitment is emphasized, and people are incited to express ideas. Decision-making is often conducted through informal channels.

*Hierarchy Culture.* Organization with this type of culture is highly formalized and structured place. Formal procedures and rules guide everyday work of people. The most important thing is to achieve efficient, harmonious and smooth functioning of organization. Following the same rules and procedures is what holds people together. A long-term efficiency, low costs and harmonious functioning are emphasized. Stability, predictability and safety of employment are highly valued. Internal and control orientation in this type of culture form orientation towards rules in which rationality, procedures, hierarchy, authority and labor division are emphasized.

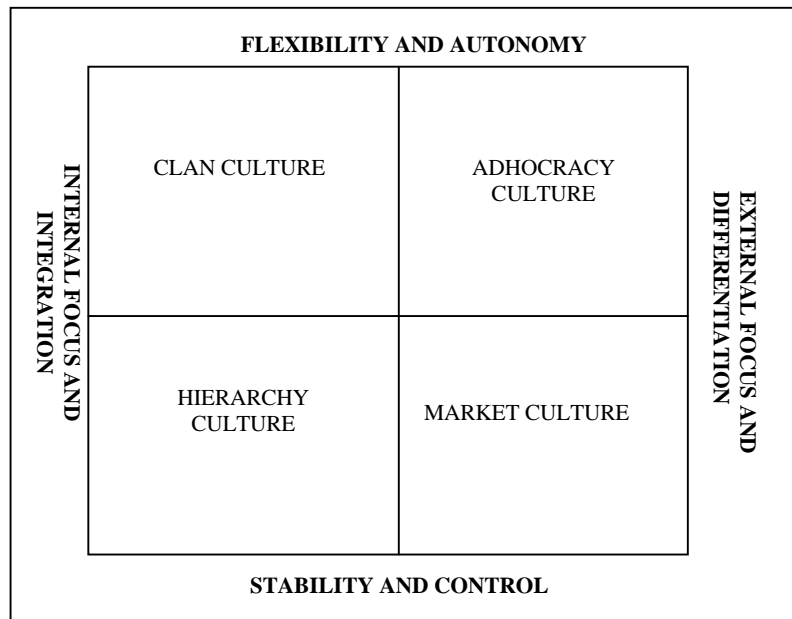

**Figure 2: Competing Values Framework.**

Source: Cameron, K.S., Quinn, R.E. (2006). *Diagnosing and changing organizational culture: The competing values framework*. Reading, Ma: Addison-Wesley

*Adhocracy Culture.* This culture makes organization a dynamic, creative and entrepreneurial place. People are incited and they are expected to take actions and assume risks. Leaders are innovators and the ones who assume risks. People in organization are connected by the desire for experimenting and trying out new things. In the long-run, the emphasis is on growth through obtaining new resources. Success in organization is measured by new products or services. Individual initiative and autonomy are encouraged. External and flexibility orientation in this type of culture implicate orientation towards innovations and include changes, innovations, information seeking, anticipation, openness and experimenting.

*Market Culture.* With market culture, organization is oriented towards result – the main concern is to get the job done. People are expected to be competitive, and targeted and result oriented behavior is also expected. Leaders encourage hard work, achieving of the results and competitiveness among employees. People are held together by the desire for success. In the long-run, the emphasis is on success on the market and achieving of measurable results in it. Success is measured by market share, sales as well as by financial measures of business operations. Strong competition, both on the market as well as within the organization, is highly valued. The combination of external focus and control in this type of culture results in orientation of managers and employees towards goals: rationality, performance, accomplishments, responsibility, and performance-based system of rewards.

### **Direction of organizational culture impact on motivation**

Research of the direction of organizational culture’ impact on motivation of employees implies establishing a causal relations between identified kinds or types of organizational culture and identified needs and motives of employees. We have previously identified organizational culture types as: clan culture, hierarchy culture, market culture, and adhocracy culture. We have also identified three basic groups of needs and motives of employees in organizations which are impacted by culture



as: belongingness needs, safety needs and growth and self-actualization needs. Now it is necessary to develop hypotheses on their interrelations.

Having in mind the values of a clan culture, we may establish three hypotheses on its impact on satisfying the needs and motives of the members of an organization. First, we may establish the hypothesis that in organizations dominated by this type of culture, the employees will to a high degree be able to satisfy the belongingness needs. Organization with this type of culture is perceived as an extended family, the leader has an obligation to look after the needs of employees, and employees maintain very close mutual interrelations with an intensive communication. All this enables the employees in such an organization to feel as a part of the family. And when the leader is also a charismatic person and develops a clear mission of organization, then the members of an organization will be committed to both the organization and its leader.

Second, we may establish the hypothesis that, having in mind the low degree of formalization and specialization, as well as a high authoritarianism of the leader, the employees in this type of culture will not be able to significantly satisfy their need for safety. Organizations with a clan culture are prone to changes dictated by the leader, but those changes are most often unplanned, spontaneous and improvised. Since everything depends on the leader and his/her will and since the structures are very loose and specialization and formalization are low, the employees cannot feel safe in such an organization. Still, this connection is of moderate strength since some employees can obtain the feeling of safety out of confidence in and commitment to the charismatic leader, as well as out of close relationship with the leader.

Third, we may assume that most employees in a clan culture will not be able to satisfy the needs for achievement, growth and self-actualization. Given the very high centralization of decision-making and authoritarian and also often charismatic leadership, the members of organization do not have enough space to express their potentials. Organization is, above all, dependent on its leader who, indeed, can satisfy his/her need for achievement and self-actualization, but this precisely inhibits the satisfying of the same needs of his/her employees. „Grass doesn't grow under an old oak“ is an old folks saying which metaphorically depicts the clan culture's impact on satisfying growth needs of the members of an organization. Hence, it is no wonder that in this type of culture the so-called “spin-off” effect is most often encountered: since the members of an organization with emphasized needs for achievement, growth and self-actualization cannot satisfy these needs in the present organization, they leave it and establish new organizations of the same type, which will compete with the organizations that they previously belonged to and in which they will, as leaders, be able to satisfy their growth needs. Still, this negative correlation between clan culture and satisfying the needs for achievement is of moderate intensity, because in organizations with this type of culture there are always some employees who, due to their close relationship with the leader and the confidence the leader has in them, receive tasks which enable them to satisfy their need for achievement. Thus we may establish the following hypotheses:

*H<sub>1</sub>: Domination of clan culture in an organization is positively and highly correlated with satisfying the belongingness needs of its members.*

*H<sub>2</sub>: Domination of clan culture in an organization is negatively and moderately correlated with satisfying the safety needs of its members.*

*H<sub>3</sub>: Domination of clan culture in an organization is negatively and moderately correlated with satisfying the needs for growth of its members.*

Hierarchy culture is a bureaucratic culture based on rationality, logic, competence, objectivity, formalization, standardization and specialization. In this culture, the metaphor for organization is a

## THE IMPACT OF ORGANIZATIONAL CULTURE ON MOTIVATION

---

machine in which people are reduced to the level of disposable parts. Organization functions through strict following of highly developed and formalized procedures, rules, guidelines, etc. Technical competencies and performances of employees and managers are the basic criterion and condition of their advancement.

Based on hierarchy culture characteristics, we may establish three hypotheses on its implications on satisfying the needs of the members of an organization. First, we may establish the hypothesis that employees in organization dominated by this type of culture will be able to satisfy their safety needs to the highest degree. Bureaucratic organization based on a hierarchy culture is highly formalized and all the processes in it take place according to the defined in advance and formalized procedures, while work tasks are highly specialized and determined by guidelines and rules. If an employee performs his/her tasks according to the procedures and rules, regardless of the results of the task performing, he/she is absolutely safe and protected against self-willedness of managers. In a true bureaucracy, everyone is entirely safe and protected as long as they obey the structures, systems, rules and procedures. In addition, bureaucratic organizations are usually very large organizations, which are difficult to change and rarely fail, and that creates an additional feeling of safety among their members.

Second, we may establish the hypothesis that satisfying the belongingness needs of the members of an organization will be highly inhibited in a hierarchy culture. The metaphor of the machine, which is most often used to describe organizations with hierarchy culture, is in itself indication enough about the inability of satisfying the belongingness and relatedness needs. Bureaucratic organizations strive to an ideal of achieving maximum depersonalization of their structure and of personalities of their employees having no influence on the organization. Such organizations are perceived by the employees as “cold” and “inhumane”. Rules and procedures are more important than people. Employees perform their strictly specialized tasks and have no room for bonding with others.

Third, it may be assumed that in a hierarchy culture the members of an organization cannot significantly satisfy their needs for growth, achievement and self-actualization. Precisely due to the fact that in bureaucratic organizations everybody must follow procedures and perform highly specialized tasks exactly the way it was determined by organizational rules and regulations, the employees have no room for satisfying the needs for achievement and self-actualization. Employees in such organizations are more oriented towards “climbing” the hierarchical ladder than towards creativity, accomplishment, initiatives, and self-actualization. But, some employees can even in bureaucratic organizations still satisfy the needs for achievement or growth. These are employees who belong to techno-structure (Mintzberg, 1979), which precisely prescribes the procedures and rules for all other employees in the organizations. Based on everything above said, we may establish the following hypotheses:

*H4: Domination of hierarchy culture in an organization is positively and highly correlated with satisfying the safety needs of its members.*

*H5: Domination of hierarchy culture in an organization is negatively and highly correlated with satisfying the belongingness needs of its members.*

*H6: Domination of hierarchy culture in an organization is negatively and moderately correlated with satisfying the needs for growth of its members.*

Market and adhocracy cultures in Competing Values Framework emphasize orientation towards tasks and results. Competitiveness, hard work and accomplishment are highly valued in these cultures. They are indeed team-oriented, but the individuality of the members of an organization is still

preserved. These two types of cultures are extremely oriented specifically towards consumers' needs and creating value for consumers. Organizations dominated by these types of cultures are flexible, since they highly value changes, tolerance to risk-taking and uncertainty. Learning is expected of all the members of an organization, since it is the only way to build individual and organizational competency which is the foundation of both personal as well as organizational performance. Decision-making is mostly decentralized and employees' participation, especially participation of experts, in decision-making is high. Besides common elements, each of these cultures also has some specific characteristics. The ideal in adhocracy culture are innovativeness and creativity, and it also has a longer time-horizon. In contrast, market culture above all values the market result achieved in the short-term, and does so in the form of quantitative measures: sales, profit, market share, etc.

Having in mind these characteristics of market and adhocracy cultures, we may establish three hypotheses on their impact on motivation of employees. First, adhocracy and market cultures are suitable for satisfying the needs for achievement, growth and self-actualization of its members. From the description of these cultures, it is notable that organizations dominated by these cultures are the places where employees are required to and expected to: be competent and to constantly develop and improve their competence, to work hard and put in effort in results achieving, to be creative and innovative, and to achieve results. Thus, it is clear that these organizations are a suitable context for the people who most value satisfying the needs for growth.

Second, we may establish the hypothesis that adhocracy and market cultures are not at all suitable for satisfying the safety needs of employees. These cultures highly value changes and flexibility, competitiveness between employees and their development. Risk and uncertainty are accepted in these cultures. Therefore, organizations dominated by these types of cultures are on no account the places where employees who seek safety above all would be satisfied.

Third, we may establish the hypothesis that adhocracy and market cultures are partly not suitable for satisfying the belongingness needs of employees. In these cultures, individuality is highly emphasized (especially in adhocracy culture), as well as competitiveness among the employees (especially in market culture). Organizations dominated by these types of culture are highly competitive places with little mercy for those who do not achieve results and are not competent. Relations between employees are created rather based on cooperation in performing of tasks that on solidarity, identification with a social group or emotive relatedness. It is natural that employees in such environment cannot satisfy the need for belongingness. Still, teams make sure that the impact of adhocracy and market cultures on satisfying the need for belongingness is not entirely negative. Within teams, often formed in such organizations, the expert employees can to a certain extent satisfy the belongingness need. Although there is rivalry within teams, some teams are still created as a separate entity and develop their own group culture so the employees can identify with them, relate to them and thus, at least partly, satisfy the need for belongingness. Hence, we may establish the following hypotheses:

*H7: Domination of adhocracy and market cultures in an organization is positively and highly correlated with satisfying the needs for growth of its members.*

*H8: Domination of adhocracy and market cultures in an organization is negatively and highly correlated with satisfying the safety needs of its members.*

*H9: Domination of adhocracy and market cultures in an organization is negatively and moderately correlated with satisfying the belongingness needs of its members.*

**Conclusions**

By summarizing all the hypotheses on implications of different organizational culture types on the possibility of satisfying different needs and motives of the members of an organization, we have reached the following conclusions. First, three organizational culture types are relevant from the aspect of the impact of culture on motivation: 1. clan culture; 2. hierarchy culture; and 3. adhocracy and market cultures. Second, the stated organizational culture types impact the possibility of satisfying the following needs or motives: 1. needs for belongingness; 2. safety needs; 3. needs for growth. Third, each of the stated three types of cultures positively affects satisfying of one group of needs and inhibits, more or less, satisfying of the other two groups of needs. Clan culture represents a suitable context for satisfying the need for belongingness, hierarchy culture provides for satisfying the safety need, while adhocracy and market cultures facilitate satisfying the needs for growth. Clan culture inhibits satisfying the needs for growth as well as safety needs, hierarchy culture is a negative context for satisfying the needs for growth as well as the needs for belongingness, while adhocracy and market cultures are not a good context for satisfying the safety needs and also the needs for belongingness. Fourth, different organizational cultures are suitable for employees with different intensity of certain needs and motives. Employees with a strong need for belongingness are motivated the most when they work in organizations dominated by clan culture. They will not be motivated at all to work in organizations dominated by hierarchy culture, and will also partly not be motivated in market and adhocracy cultures. Employees with a strong safety need will have best conditions for satisfying these needs in hierarchy culture, hence they will be motivated the most in such cultures. However, they will not be motivated in all other cultures since they are unfavorable context for satisfying the safety needs, which is especially true for market and adhocracy cultures. Finally, employees who most value the needs for achievement, self-actualization and growth will be motivated the most in adhocracy and market cultures. On the other hand, these employees will have difficulties in satisfying the needs for growth in hierarchy culture, and to a lesser extent also in clan culture. These conclusions are very important both for human resources management policies and practice, especially in the field of recruitment and selection, as well as for leadership style in an organization.

**Table 1: Summary of the impact of organizational culture on motivation**

	Safety Needs	Belongingness Needs	Growth Needs
Hierarchy culture	++	--	-
Clan culture	-	++	-
Market and adhocracy cultures	--	-	++

**References**

Alderfer, C. (1972). *Existence, Relatedness and Growth*. New York: Free Press.  
 Alvesson, M. (2002). *Understanding Organizational Culture*. London: Sage.  
 Brown, A. (1998). *Organizational Culture*. Edinburgh: Pearson Education.  
 Cameron, K. S. and Quinn, R. E. (2006). *Diagnosing and Changing Organizational Culture: The Competing Vales Framework*. Reading, Ma: Addison-Wesley.  
 Dandridge, T., Mitroff, I. and Joyce, W. (1980). Organizational Symbolism: A Topic to Expand Organizational Analysis. *Academy of Management Review*, 5, 77–82.  
 Herzberg, F. (1968). One More Time: How Do You Motivate Employees? *Harvard Business Review*, 46, 53–62.

- Janićjević, N. (2011). Methodological Approaches in the Research of Organizational Culture. *Economic Annals*, 46, 69–100.
- Janićjević, N. (2010). Organiozaciono ponašanje, Beograd: Data status.
- Mahal, P.K. (2009). Organizational Culture and Organizational Climate as a Determinant of Motivation. *The IUP Journal of Management Research*, Vol. VIII, No. 10.
- Martin, J. (2002). *Organizational Culture: Mapping the Terrain*. London: Sage.
- Maslow, A., (1943), A Theory of Human Motivation, *Psychological Review*, 50, 370–396.
- McClelland, D. (1966). *That Urge to Achieve*, THINK Magazine.
- Mintzberg, H. (1979). *The Structuring of Organizations*. Englewood Cliffs: Prentice Hall.
- O'Reilly C.A., Chatman J. And Caldwell D.F. (1991). People And Organizational Culture: A Profile Comparison Approach To Assessing Person-Organization Fit, *Academy of Management Journal*, 34, 487-516.
- Schein E. (2004). *Organizational Culture and Leadership*. Thousand Oaks: Sage.



# BOARD STRUCTURE AND CORPORATE PERFORMANCE: TRADITIONAL VS. CONTEMPORARY APPROACH

Verica Babić<sup>1</sup>

Jelena Nikolić<sup>2</sup>

Jelena Erić<sup>3</sup>

**Abstract:** *In dealing with the agency problem, the board as an internal mechanism of corporate governance has a control role in order to protect the owners' best interests. In addition to control, the board has a strategic role in the process of strategy formulation and implementation. In line with board roles, board effectiveness, seen as the degree to which boards are successful in carrying out their roles, represents an important determinant of corporate performance. Traditional approach has been based on the hypothesis that board structure determines its effectiveness. However, the empirical research dichotomy and new research perspectives indicate that board structure is significant, but not the only factor affecting board effectiveness and, consequently corporate performance. In this paper, we analyze relationship between the board structure and corporate performance. Starting from traditional perspective limitations, this paper contributes by proposing contemporary framework and expanding the understanding of the interdependence between board effectiveness and corporate performance.*

**Keywords:** *board structure, board effectiveness, corporate performance, corporate governance, contemporary approach.*

## Introduction

In the study of corporate governance, the essential issue is how to ensure that managers act in the best interest of owners. According to the agency theory, in terms of separation of ownership and control, the interests of owners and managers may collide, resulting in traditional agency problem between the owner (*principal*) - manager (*agent*). The agency theory hypothesis that managers as shareholders' agents may make decisions contrary to the owners' interests. In dealing with the agency problem and conflict of interests, the board as an internal mechanism of corporate governance has a role to monitor and control managers, in order to protect the owners' best interests. In addition to control, the board has a strategic role, which evolved from the strategy evaluation and ratification, to active participation in the process of formulation and implementation.

Traditional approach has been based on the hypothesis that board structure determines its effectiveness, and consequently, on corporate performance. Therefore defining the actual board structure becomes crucial. Board structure is evaluated on the basis of three structural variables: board composition, leadership structure and board size. Traditional perspective further argues that understanding of board structural variables was a sufficient basis for defining the principles and the formulation of regulations required for effective corporate governance. In addition, board effectiveness, seen as the degree to which boards are successful in carrying out their roles, represents an important determinant of corporate performance. In the line with traditional approach, *research paper focuses* on interdependence between the board structure and corporate performance. *The main*

---

<sup>1</sup> Faculty of Economics, University of Kragujevac

<sup>2</sup> Faculty of Economics, University of Kragujevac, jnikolic@kg.ac.rs

<sup>3</sup> Faculty of Economics, University of Kragujevac

## **BOARD STRUCTURE AND CORPORATE PERFORMANCE: TRADITIONAL VS. CONTEMPORARY APPROACH**

---

*research objective* is to investigate correlation between board structural variables and corporate performance. Relevant *hypothesis* paper is based on are:

- H1: *The proportion of independent, non-executive directors is positively related to corporate performance.*
- H2: *CEO duality is negatively related to corporate performance.*
- H3: *Board size is negatively related to corporate performance.*

In order to test hypotheses, *the method* of secondary data comparative analysis is applied, examining the impact of the board effectiveness on corporate performance. The paper is expected *to contribute* to recent research efforts by expanding the understanding of corporate performance improvement. This paper will address several research issues. *First*, traditional model of board effectiveness will be analyzed, as well as limitations. Although the traditional research find the board structure to be the key board effectiveness factor, the empirical research dichotomy indicate that board structure is significant, but not the only relevant factor. Traditional approach proved to be inadequate as board structure has important, but not decisive effect on board effectiveness and corporate performance. *Second*, traditional approach results ambiguity leads to development of new approaches to this issue. One of these contemporary approaches, emphasizing socio-psychological factors in the board effectiveness research is presented in final section of this paper. *Finally*, other relevant factors are highlighted too, such as institutional framework, ownership structure, managerial discretion etc.

### **The traditional model: Board structure as a factor of board effectiveness**

The formal board structure is topic that has been widely analyzed in the field of corporate governance is. The key discussion questions are: what is the appropriate balance between executive and non-executive directors; what is the appropriate size for the board; what is the optimal leadership structure (Tricker, 2009, p. 61).

From the traditional perspective, the board effectiveness is evaluated on the basis of three structural variables: the board composition, namely the proportion between external, independent and internal board directors, leadership structure, duality in board chairperson and CEO positions, and the board size.

### **Board composition**

The board composition indicates the ratio between the number of non-executive, independent directors (outsiders) and the number of executive directors (insiders), based on following classification of board directors (Tricker, 2009):

- *Executive director* - is a member of the board who is an executive manager, too;
- *Non-executive director* - is a board member who does not hold any executive management position;
- *The affiliated or connected non-executive director* - is director who, even though not being a manager, does have some relationship with the company. The relationship might be that the director is a retired executive of that company; is a close relative of the chairman; was



nominated by a large shareholder; is linked with major supplier, distributor, customer, or financial partner; etc.;

- *The independent non-executive director* - has no affiliation or other relationship with the company that could affect the exercise of objective, independent judgment. The independent non-executive director's role essentially could be perceived from two different points of view (Mallin, 2010, p. 173). One, that has been given much emphasis in the last decade, is as a control of executive directors. Second is contribution that non-executive directors can make to the overall leadership and development of the company.

In accordance with previous deliberation, we can conclude that even among non/executive members differences exist in terms of their roles. There is a difference between the *non-executive director* and *non-executive independent director*. The idea of non-executive directors independence is emphasized in various codes and reports: *Cadbury Report* (1992) stated that non-executive directors should be independent of management and free from any business or other relationship which could materially interfere with the exercise of their independent judgment; *OECD principles* (2004) stated that a sufficient number of board members will need to be independent (regulatory rules should define the necessary and sufficient number of independent directors); *The Combined Code* (2008) states that the board should identify in the annual report each non-executive director it considers to be independent. Although there are different independence standards, the key risk for investors is that the independence standards will not in reality result in truly independent directors. The United Kingdom *Corporate Governance Code* sets out a number of tests for independence. Non-executive independent position will be compromised if (Bain & Barker, 2010, p. 62): they've been appointed by a major shareholder; they have significant links with other directors; they have close family ties to the business, including ties to its advisers; they receive remuneration and rewards from the company other than their fees or have been an employee of the company within the past five years; their term of office exceeds nine years.

According to various codes, it can be conclude that independence is a complex issue. It is generally taken as meaning that there are no relationships or circumstances that might affect the director's judgment. Independence is defined as having "*no material relationship with the listed company, either directly or as a partner, shareholder, or officer of an organization that has a relationship with the company*" (Mallin, 2010, p. 175). Independence is important for monitoring role performance. It enables a director to objectively evaluate the top executives, strategy, business model and risk management policies. It also provides mean for objective measurement of corporate performance against predetermined targets. Independence means that compensation arrangements are established through arms-length negotiation and that acquisitions are determined in the best interest of shareholders (Larcker & Tayan, 2011, pp. 142-143). While definitions of independence vary, most agree that in order to be independent, director should not have any other relationship to the company aside from the position in the board. This excludes not just full-time employees, but also employees' family members and consultants (Monks & Minow, 2002, p.190).

In reference to the definitions of independence and previous classification of board directors, generally, there are four possible board structures – a board with all executive directors, a board with a majority of executive directors, a board with an majority non-executive director, and board with non-executive directors only (Tricker, 2009, pp.60-63).

*In the all executive director board* the top managers are also the directors. This structure is found in many small, family firms and start-up businesses. The key determinant is that directors on such boards rarely make clear distinction between their roles as managers and their roles as directors.

## **BOARD STRUCTURE AND CORPORATE PERFORMANCE: TRADITIONAL VS. CONTEMPORARY APPROACH**

---

*In the majority executive director board* some non-executive directors have been included in the board decision making, even though remain minority. Non-executive directors participate in board activities for various reasons. The executive directors of a successful, growing company may feel the need for additional expertise to back up their own experience, get involved in new technologies, or face more complex managerial or financial issues. However, in the majority executive director board, executive directors continue to exercise considerable power. The conventional wisdom was that non-executive directors could be quite useful on board, adding additional experience, and insights to discussions, but they should never be majority. In that sense, executive directors wielded the power over what they perceived as "their" company. However, the majority of the boards of the most successful listed companies are dominated by non-executive directors and the most of them are likely to be independent.

*When non-executive directors are in the majority*, the board culture, its internal relationships and activities are in most cases different comparing to boards dominated by executive directors. Consequently, the outside directors are expected to provide oversight and supervision of executive activities, the achievement of corporate objectives and assurance of compliance with corporate governance regulations.

*In the all non-executive directors board* the outside directors are expected to execute duties without undue influence from management, because they don't have to report to the CEO. They are expected to provide expertise and guidance in defining company strategy and business model, and are better in performing monitoring role of the board comparing to insiders. However, outside directors tend to have less information about internal activities than inside directors. This information gap is more likely to occur when specialized knowledge is required to run the company. Quality of decision making can be jeopardized when information gap occurs or when outsiders lack independence (Larcker & Tayan, 2011, p. 139).

Although companies are required to meet the independence standards, it does not guarantee that outside directors are truly independent. From this perspective, when being nominated by insiders, outsiders are formally independent, but in reality they are not. When this occurs, quantitative indicator for outside representation becomes deceiving. These findings indicate the need for a further research of board composition and members' characteristics.

### **Leadership structure**

Leadership structure can be defined as duality in board chairperson and CEO positions. The key dilemma about leadership structure in contemporary corporate governance literature is whether the chairman and CEO roles should be combined in one person or not. The chief executive officer (CEO) has the executive responsibility for the running of the company; on the other hand, the chairman has other responsibilities: presiding the board, making sure that directors have all the necessary information and provide equal opportunity to participate in board decision making (Mallin, 2010, p. 167). The primary task of the chairman is to chair their boards. This is what they have been appointed to do and, the duties at the top of company may be divided, chairing the board is their responsibility alone (Cadbury Report, 1992). The difference between the authority of chairman and that of chief executives is that chairmen carry out the authority of the board, while chief executives carry out the authority delegated to them by the board.

According to the agency theory and *UK Code on Corporate Governance*, the roles of chairman and CEO should not be exercised by the same individual. The division of responsibilities between the chairman and CEO should be clearly established (*UK Code on Corporate Governance*). The two roles should not therefore be combined and carried out by one person, as this would give an individual too much power. The argument is that separation leads to the balance of power distribution, avoids the

potential for power abuse, and enables the chief executive to concentrate on management, whilst the chairman handles the running of the board and relations with shareholders (Tricker, 2009, p. 58).

Despite the well honed recommendation around the world that the chairman/CEO positions should be separate, in the United States the roles are frequently combined. According to stewardship theory, duality in positions has a positive implication on the board effectiveness since this enables the power and authority to be concentrated in one person acting in best company's interests (Daily & Johnson, 1997). It is more important to establish the organizational structure that will facilitate corporate governance, than enable monitoring and control of management (Davis, Schoorman, & Donaldson, 1997). Duality in positions makes sense, because the CEO knows the way the company operates.

The CEO has greater access to current and comprehensive information about the state of the company comparing to other board members, resulting in disbalance of power and influence in his favor. In contrast, the typical outside director's access to information about company affairs is limited, in most cases due to the part-time nature of the directors' engagement. Lack of information puts directors at a serious disadvantage when it comes to assuming a leadership role in boardroom discussions (Conger, Lawler, & Finegold, 2001, p. 58). The arguments in favour of combined roles is that a one leader should run dynamic organization, while dividing leadership duties leads to conflict (Tricker, 2009, p. 59). In addition, there are clear advantages of combining the CEO and chairman roles. By centralizing board leadership in a single individual, there is no ambiguity concerning who runs the business. This way any possibility of dysfunctional conflict between CEO and board chairman is eliminated, while positive effects are generated. The combined CEO/chair roles make it easier for CEO to take the advantage of the board as an advisory body (Conger, Lawler, & Finegold, 2001, p. 59).

Recently, a number of dramatic and heavily reported companies in the US collapsed, apparently due to abuse of power by the head of the company. It is therefore obvious that institutional investors should make additional efforts in order to separate these roles. A powerful argument against duality in positions of board chairman and CEO is that they are fundamentally different. CEO was appointed to lead the company, while the chairman was appointed to lead the board (Nikolic & Erić, 2011).

In parallel with different research results and conclusions, the roles of chairman and CEO continue to be one of the unresolved dilemmas in corporate governance (Chia-Wei Chen, Barry Lin, & Bingsheng Yi, 2008). Many governance experts assert that it is important to separate positions of chairman from the position of CEO (Dalton & Dalton, 2005; Roberts, McNulty, & Stiles, 2005). This argument is gaining widespread support as a corporate governance best practice. However, when the roles of chairman and CEO are separated, the relationship between the chairman and CEO is one of most crucial and delicate relationships in organization. It is the case because these may be the people of significance with high public profiles, and big stakes can be involved. It involves close liaison between two persons, each of them having the power to influence another one (Tricker, 2009, p. 257). Although it is difficult to maintain the proper leadership balance between the board chair and the CEO, it can be concluded that separation of positions is a preferable solution.

### **Board size**

Board size, defined as a number of board members, is another issue under dispute. The board size has tendency to be related to the company size (for instance, companies with annual revenues of 10 million \$ have 7 directors, on average, and companies with revenues of more than 10 billion \$ have 11 directors, on average) (Larcker & Tayan, 2011, p. 155). Optimal board size may vary according to the board's life cycle, its mission, as well as fundraising requirements.

## **BOARD STRUCTURE AND CORPORATE PERFORMANCE: TRADITIONAL VS. CONTEMPORARY APPROACH**

---

Agency theory standpoint is that the number of board members is an indicator of CEO domination. The number of members and the degree of CEO's domination are negatively correlated, leading to improved management monitoring (Zahra & Pearce, 1989). Larger boards have more resources at disposal to dedicate to both, oversight and advisory function (Larcker & Tayan, 2011, p. 155). They have an enhanced capacity for co-opting external influences and generating critical resources (Johnson et al., 1996), as well as take the advantage of experience diversity (Larcker & Tayan, 2011, p. 55).

However, Hermalin and Weisbach (2003) argued that larger boards can be less effective than small boards. A large board meetings could result in increased potential of conflict, since expressing opinions within a large group is generally time consuming and frequently results in a lack of cohesiveness (Lipton and Lorch, 1992). In addition, the problem of coordination outweighs the advantages of having more directors (Jensen, 1993) and it often moves into a more symbolic role (Hermalin & Weisback, 2003).

Board size may affect the strategic board role. According to Judge and Zeithalm (1992) board size is negatively correlated with the degree of board involvement in strategic decision-making. When the boards are large, constructive discussion and creative conflict between the members are facing constraints. Large boards suffer from ineffective decision making, less candid discussion, responsibility overlap, and risk aversion (Larcker & Tayan, B, 2011, p. 155). In addition, if the strategic changes in company's development are analyzed it can be concluded a negative correlation between the board size and the degree of strategic changes exists (Levrau & Van den Berghe, 2007b). Given the tradeoffs, many experts believe theoretically optimal board size exists. Over time, as the function of the board changed from being almost symbolic to nowadays when boards fulfill their responsibilities in full capacity, there was a need for resizing. Generally, the average board is getting smaller, and therefore the board dynamic is easier. Moreover, with the rapid rise in directors' compensations, the costs of large board are being assessed against the possible benefits, and in many cases the conclusion has been that the costs far exceed the benefits. There are many possible explanations, but probably the most important is that boards are becoming more functional. Another reason has been the increase of the responsibilities and directors duties, both through legislative and regulation. Directors are fulfilling obligations, and within a smaller, more structured board, they are in better position to do so (Leblanc & Gillies, 2005, p. 119).

Much of the public debate on board structure has focused on pressure for smaller board size. It is argued that although larger board size initially facilitates key board roles, there comes to the point when larger boards suffer from coordination and communication issues, and hence board effectiveness declines (Lipton & Lorsch, 1992; Jensen, 1993). Lipton & Lorch (1992) recommended limiting the number of directors to seven or eight, as more than that would be difficult for the chairman to control. On the other hand, small boards lack the advantage of having the spread of expert advice and opinion. Large boards have in their disposal diversity in terms of experience, skills, gender and nationality (Dalton & Dalton, 2005). "Expropriation of wealth" by the CEO or inside directors is relatively easier with smaller boards due to relatively few outside directors. Directors in a small board are preoccupied with the decision making process, lacking time for monitoring activities (Shakir, 2008).

### **The traditional model of board effectiveness**

From traditional perspective, the board effectiveness model based on the assumption that the board structure determines its effectiveness and the company's financial results has been developed (Zahra & Pearce, 1989; Daily & Dalton, 1994; Dalton et al., 1998; Dalton et al., 1999). The theoretical research framework is based on agency theory and stewardship theory. With reference to the main agency theory hypothesis, the board effectiveness is affected by degree of its independency from the

management. It is thus logical to conclude that the board should be composed of a large number of independent directors (Babić, Nikolić, & Erić, 2011). Thus, research evidence findings suggest that boards composed of a large number of independent, non-executive members are more effective due to enhanced capacity of exercising objective control of managers (Johnson, Daily, & Ellstrand, 1996). According to the agency theory, the position of the chairman and CEO should be separated. However, with reference to the stewardship theory which argues that the management act in the owners' interest, the boards composed of a large number of internal, executive members have better performance. Also, duality chairman/CEO position has positive influence on the board effectiveness. Board effectiveness depends on its strategic role implicitly affirming the hypothesis that the boards composed of a large number of internal, executive members are in fact more effective ones, for the executive members possess the required knowledge, skills, and information for making the strategic decisions (Levrau & Van den Berghe, 2007a). The given stances being at odds indicate that correlation between board composition and effectiveness in fact depends on the theoretical research framework and the role of the board whose effectiveness is being evaluated (Babić, Nikolić, & Erić, 2011).

Although the results of empirical studies referring board structure impact on the board effectiveness are ambiguous, it can be concluded that traditional research is based on the idea that the structural characteristics determine the board effectiveness, and therefore corporate performance. In the context of these considerations, defining the principles and regulations regarding board structure are major prerequisite for effective corporate governance. Improvement in corporate governance can be achieved through restructuring the board, which means increasing the number of non-executive independent directors, the separation of the board chair and the CEO position, and defining optimal board size (Dalton et al., 1994).

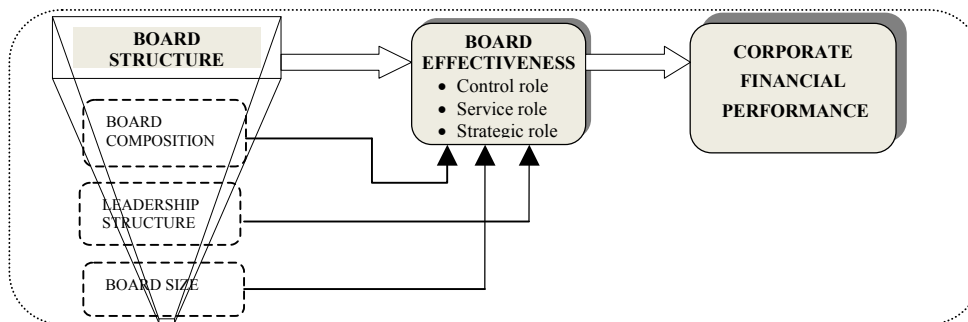

**Figure 1. Traditional model of board effectiveness**

Source: Adapted from Leblanc, R. & Gillies, J. (2005). Inside the boardroom. John Wiley and Sons, Canada, p. 133.

### **Board structure and corporate performance**

Although in many cases implicit, claims that codes and regulations designed to improve corporate governance have been devised primarily to eliminate conflict and to restrain managers' power, until nowadays researchers are making considerable effort to determine whether the changes in board structure have impact on corporate financial performance, as well. Measures such as Return on Assets (ROA), Return on Equity (ROE), Dividend Yield (DY), Tobin Q and EPS (Earnings Per Share) are financial performance measures that are most frequently used at academic research. These measures of corporate performance have been used extensively in research in corporate governance. ROA measures how much profits a firm can achieve using one unit of assets. It helps to evaluate the result of managerial decisions on the use of assets which have been entrusted to them. ROE measures

## BOARD STRUCTURE AND CORPORATE PERFORMANCE: TRADITIONAL VS. CONTEMPORARY APPROACH

---

the earnings generated by shareholders' equity of a period of time, usually one year. It encompasses three main levers which management can utilize to ensure health of the firm: profitability; asset management; and financial leverage. DY refers to the annual dividend per share divided by current stock price. DY is an easy way to compare relative attractiveness of various dividend-paying stocks. Tobin Q refers to the market value of total assets divided by the book value of total assets. Earnings per share refers to the portion of a company's profit allocated to each outstanding share of common stock (Topak, 2011; Ongore & K'Obonyo, 2011). In the following considerations, different empirical research results exploring this relationship between the key structural variables and corporate financial performance will be discussed.

### Board composition and corporate performance

There is disagreement among researchers regarding the optimal board composition. According to Zahra and Pearce, (1989) effective boards will have high *proportion of outside directors*. Daily and Dalton (1994) explore key determinants of the relationship between board composition and financial results, highlighting that successful companies tend to have a higher percentage of external directors. According to Johnson et al. (1996), the boards with more independent, non-executive members are more effective, due to increased ability to control managers, therefore contributing increased financial performance.

Even so, there is insufficient and contradictory empirical evidence that a preponderance of outside directors is associated with improved corporate performance. Some researchers argue that: higher outsider ratio is positively correlated with enhanced corporate performance (Daily & Dalton, 1994), is not a factor influencing performance (Kesner & Johnson, 1990, Daily & Dalton, 1992; Daily & Dalton, 1993), or has negative effect on corporate performance (Baysinger, Kosnik, & Turk, 1991; Goodstein & Boeker, 1991).

Anyway, one of the most frequently referred to is the empirical study examining the relationship between the board structure and company performance in large corporations, conducted by Milstein and MacAvoy (Leblanc et al., 2005, p. 123). The study results indicate that well managed companies have, on average, 7% better performance comparing to competitors (performance measure was five years change in stock price). However, it is impossible to conclude whether the improvement in performance was due to the changes in governance or a consequence of other factors, such as substantial changes in marketplace.

Rosenstein and Wyatt (1990) argued that adding an outside director to the board leads to a statistically significant increase in stock price during initial public offering (IPO). Interestingly, added insider to the board face negative reaction by shareholders if he is minor stockholder, but their reaction is opposite if he holds major share of company stocks. The impact of outside directors on the long-term operating company performance is unclear. Bhagat and Bernard (2002) found almost no relationship between the percentage of outsiders and the long-term performance of the company's stock.

Jackling and Johl (2009) argued that the greater proportion of outside directors would be positively associated with firm performance. The results show some evidence of a positive and significant relationship between board composition in terms of outside directors and financial performance as measured by Tobin's *Q*. In Duchin, Matsusaka and Ozbas (2010) found that the effectiveness of outside directors depends on the cost of acquiring relevant information. When the access to information is facilitated, company performances rise following the appointment of outsiders to the board. Otherwise, company performances decrease. The findings tend to support the idea that outside directors are more effective when it is easy to close the information gap between insider and outsider knowledge.

However, research results are often contradictory, making it difficult to make general conclusions about the correlation between board composition and company performance. Actually, outside directors have both positive and negative influence. Outsiders have the potential to bring expertise and independence to the board, which can reduce agency costs and improve firm performance. However, outsiders tend to have information disadvantage that can decrease their effectiveness. Even though the research results are inconclusive, shareholders should pay special attention to this problem. Further research efforts should be dedicated to more in depth, reliable and comparable measurements scales.

### **Leadership structure and corporate performance**

Researchers have studied the impact of separating the chairman and CEO roles on corporate performance. Whether combining or separating the leadership is beneficial to the firm is an empirical question. However, the empirical evidence is ambiguous and inconclusive (Chia-Wei Chen, J. Lin & Bingsheng Yi, 2008). Most studies have found evidence that separation leads to improved corporate performance. According to Donaldson and Davis (1991) there is a positive correlation between the dual board structure and the company's financial results. Contrary to these findings, Rechner and Dalton (1991) indicate that the separation of chairman and CEO can be associated with better company performance. Daily and Dalton (1994) highlight some of the key aspects of relationship between board composition, leadership structure and its financial results. The results of their study provide evidence that successful companies have a higher percentage of external members and there is no duality between the position of CEO and chairman.

However, some empirical results indicate that there is no evidence that separation leads to improved corporate performance. Baliga, Moyer and Rao (1996) found that companies that separate CEO/chairman roles do not exhibit significantly positive stock price returns during IPO. They also found no evidence that change in the independence position of the chairman has any impact on the company operating performance, and only weak evidence that it leads to long-term market value creation. Similarly, Boyd (1995) provided a meta analyses of several papers on chairman/CEO duality and found, no statistically significant relationship between the independence status of the chairman and corporate performance. Due to contradictory empirical studies, general conclusion cannot be derived. The evidence suggests that an independent chairmanship does not necessarily generate improved corporate outcomes, neither duality results in diminished shareholder value. Depending on circumstances, decision of whether to split the chairman and CEO roles, or not, should stay within discretion right of shareholders (Larcker & Tayan, 2011, pp. 135-136).

### **Board size and corporate performance**

Also, researchers have examined *the relationship between board size and corporate performance*. Yermack (1996) measured the relationship between board size and firm value. He found that as board size increases, firm values going down. The largest deterioration in value occurs when board size is between five and ten directors, suggesting that inefficiencies cumulate the most within this range. The author concluded that between board size and firm value an inverse correlation exists. Van den Berge and Levrau (2004) found that board size positively influences its effectiveness in performing the control role and enhancing corporate performance.

However, Coles, Daniel and Naveen (2008) argued that other factors influence the relationship between board size and firm value, as well. The authors argued that complex companies might benefit from large boards, because they bring more information to the decision-making process. In this sense, a large board should have positive performance effect at complex companies where incremental

## **BOARD STRUCTURE AND CORPORATE PERFORMANCE: TRADITIONAL VS. CONTEMPORARY APPROACH**

---

expertise is needed. They found that board size is negatively correlated for simple firms and positively correlated for complex firms. This evidence casts doubt on the idea that smaller boards with fewer insiders are necessarily value improving (Larcker & Tayan, 2011, pp. 155-156). Although a host of theory-driven rationales suggest a relationship between board size and corporate performance, the literature provides no consensus about the nature of that relationship (Daily et al., 1999).

Using the largest sample employed to date over a long time period, Guest (2009) examines the impact of board size on firm performance. The conclusion is that board size has a negative impact on firm performance. Also, he found that large firms that have large boards, exhibit stronger negative relation board size – performance. Therefore, board size has a strong negative impact on profitability, Tobin's Q and share returns. The empirical evidence appears to support this view, with a majority of studies advocating a significantly negative relation between board size and corporate performance. If larger board size indeed "causes" worse performance, then larger boards would represent inefficient governance that could possibly be improved by a "one size fits all" approach to board size (Guest, 2009).

The above arguments were empirically tested and a negative association between board size and performance were reported by Yermack (1996), Eisenberg, Sundgren and Wells (1998) and Barnhart and Rosenstein (1998). Yermack (1996) analyzed a sample of 452 large U.S industrial corporations in period 1984-1991 and consistently found an inverse relationship between board size and firm value. Following Yermack's analysis of large firms, Eisenberg, Sundgren and Wells (1998) tested the relationship between board size and profitability of small and medium Finnish firms. They presented evidence of a negative association between board size and profitability, thus supporting the theory put forward by Lipton and Lorch (1992) and Jensen (1993). Similarly, Barnhart and Rosenstein (1998) found that firms with small boards outperform firms with large boards. Vafeas (2000) reported that firms with the smallest boards (minimum of five board members) are better informed and thus can be regarded as having increased monitoring capacities (Shakir, 2008).

Bennedsen, Kongsted and Nielsen (2004), in their analysis of small and medium-sized closely held Denmark corporations reported that board size with less than six members has no effect on performance, but significant negative relation exists when the board size increases to seven or more directors. Bennedsen, Kongsted and Nielsen (2008) approve the board directors' size is negatively related to performance on a panel of 700 companies in Denmark. Cheng et al. (2008) focused on 350 firms of Yermack (1996)'s sample over the same period approve this correlation. However, Kiel and Nicholson (2003) found a positive relationship between board directors' size and performance in Australia.

There are various arguments regarding board size. All the prior studies find either negative or positive relationship between board size and firm performance. The results of the recent study conducted by Topac (2011) contradict with the results of all prior studies. This study reveals that there is no relationship between board size and performance. Nevertheless, further research of should be carried out in order to clarify how different circumstances and variables affect relationship between board size and corporate performance.

### **Corporate board in the contemporary corporate governance approach**

Limitations of traditional research perspective and results ambiguity led to development of new research perspectives to this issue. Development of behavioral perspective indicates that the actual board structure although necessary, is not the only condition for board effectiveness as precondition for improvement of corporate performances. Boards' effectiveness has been analyzed depending on processes within boards and the board members individual characteristics and. Consistent with behavioral perspective, many authors conclude that board effectiveness is influenced by the following



board processes: cognitive conflict, efforts norms, and use of knowledge and skills. Opening the *black box* of board behaviour and understanding the board processes implies the involvement of individual characteristics of board members into board effectiveness analysis (Babić, Nikolić, & Erić, 2011).

Board effectiveness is not merely influenced by formal board structure, but is also by interactions and processes within boards. Nonetheless, this does not imply the irrelevance of structural variables, but rather suggests they should be perceived as factors influencing board behavior. The actual board structure forms a precondition for generating effective relations and interactions among board members. Studying of both structural variables in line with traditional perspective and socio-psychological factors influencing board's behavior in line with behavioral perspective is expected to offer the integrative approach.

The integrative approach encompasses both research perspectives and indicates that structural and process variables are interdependent and that their combined influence indicates on the actual degree of board effectiveness.

In general, development of integrative framework raises new issues and requires in depth analysis of factors influencing board effectiveness and consequently corporate performance. Academic debate on optimal corporate governance structure appears was mainly directed to the role of board disregarding other equally important aspects of governance such as institutional framework, ownership structure and managerial discretion. Thus, the corporate governance framework in its current form is evidently lacking monitoring, aligning the owners, directors and managers' interests and actions with wealth creation and stakeholders interests. Ownership structure has a direct bearing on the risk-taking orientation of the firm. Agency problems arise whenever investment ideas and preferences of principals (owners) are at variance with those of their agents. Hence, the board of directors acts as mediator between the principals and agents, and is in charged for three main roles: control, service and strategic. The board effectiveness seen as the degree to which boards are successful in carrying out their roles depends on both, board structure and board processes. In addition, the board helps in, among other ways, monitoring and controlling managerial discretion. Broadly speaking, there are two major influences on managerial discretion. The key internal influences moderating managerial discretion (imposed by the board) include intangible resources, firm leverage, size, organizational design and culture. Aside from internal, there are external influences that pertain to the role of markets in monitoring and controlling managers. The most significant market-related constraints arise from industry structure, managerial labor markets, product markets and financial markets.

In order to examine factors impacting corporate performance it is necessary to analyze institutional framework determining internal mechanisms of corporate governance such as ownership and board structure. Likewise, market influences and internal influences must be further investigated. Relevant conclusions referring relationship between board effectiveness and corporate performance, as well as recommended improvement measures, can be devised after comprehensive and thorough analysis above mentioned aspects. This paper, therefore, proposes a conceptual framework (Figure 2) combining various influences on corporate performance. This framework can shed more light and help in better understanding the relationship between corporate governance system and corporate performance, representing potential foundation for further research.

**BOARD STRUCTURE AND CORPORATE PERFORMANCE: TRADITIONAL VS. CONTEMPORARY APPROACH**

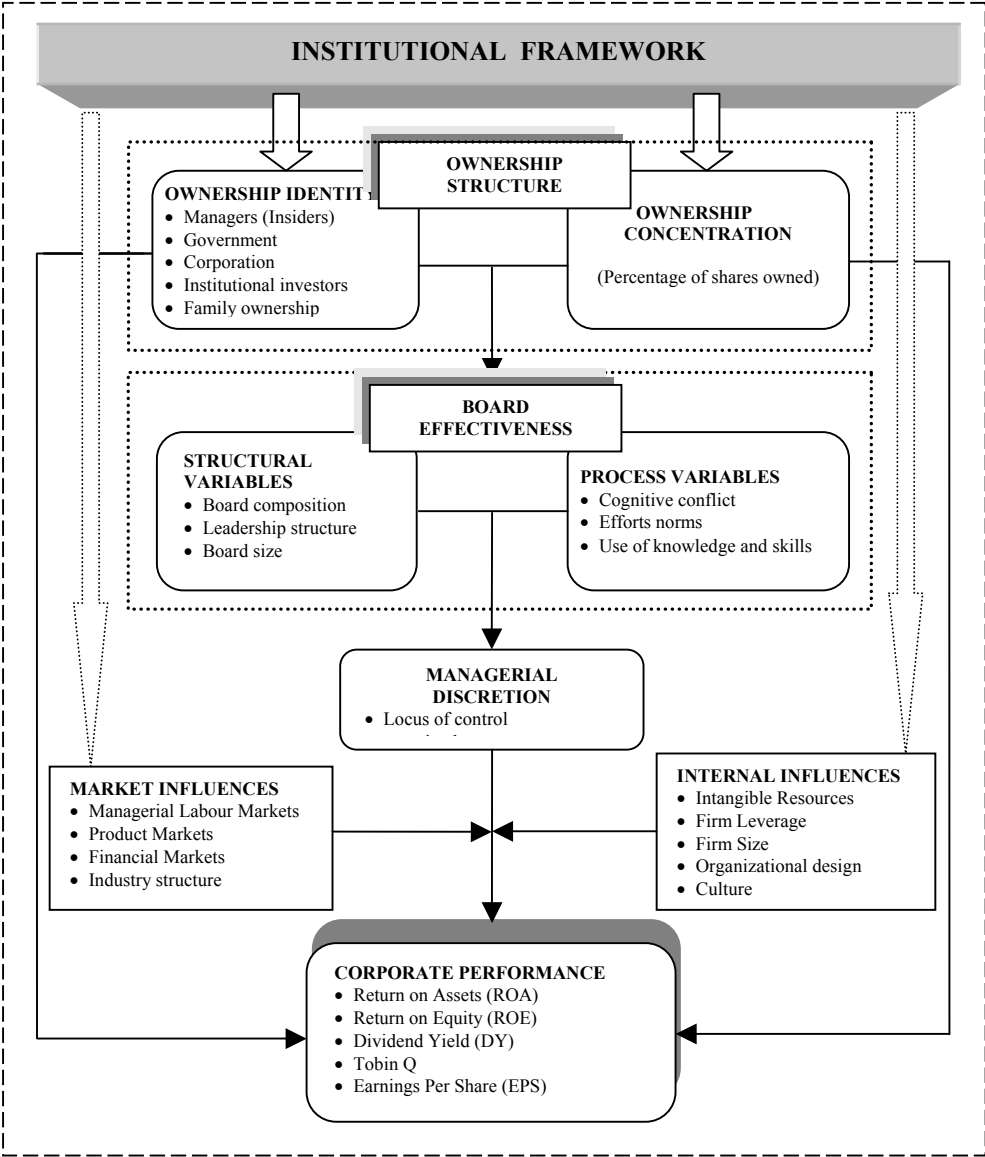

**Figure 2. Conceptual framework: Corporate governance-corporate performance relation**

Source: Adapted from Ongore, V.O. & K'Obonyo, K.O. (2011). *Effects of selected corporate governance characteristics on firm performance: Empirical evidence*. International Journal of Economics and Financial Issues, 1, 99-122.

**Conclusions**

In this area of increased attention to corporate governance, board effectiveness has taken the important role. Traditional research of factors influencing board effectiveness mainly focuses on the limited number of board structural characteristics. This approach proved to be inadequate since it

points out the fact that board structure has crucial affect on board effectiveness and corporate performance.

*Hypothesis H1* is not corroborated, since outside directors have both positive and negative influence in various circumstances, resulting in often contradictory research results. *Hypothesis H2* is confirmed, even though empirical results are not consistent, recommendation is in favor of separation between CEO and chairman position. *Hypothesis H3* affirms negative relationship between board size and firm performance, in most cases.

Starting from the limitations of traditional research and inconsistencies in empirical results, there has been the development of new behavioral approach, emphasizing the socio-psychological factors in the board effectiveness research. From behavioral perspective, board effectiveness is not merely influenced by formal board structure, but by interactions and processes within boards, as well. Clearly, structure cannot be disregarded, but results in partial consideration of board effectiveness.

In addition, recent studies indicate that it is important to take a count other relevant factors, such as institutional framework, ownership structure, managerial discretion, as well as many important internal and market influences. It is also necessary to have in mind performance evaluation indicators, either financial or nonfinancial, or both, because consistency and comparability of research results rely on them. In this paper, financial indicators are analyzed. Although there are examples of a positive correlation between the board structure and corporate performance, it is not possible make general conclusions due to the lack of empirical evidence. Therefore, future research efforts should be pointed toward combining of different research perspectives and investigating impact not only on financial, but organizational performance as well.

## **References**

- Babić, V., Nikolić, J., & Erić, J. (2011). Rethinking board roles performances: Toward integrative model. *Economic Annals*, 190, 140-162.
- Bain, N. & Barker, R. (2010). *The effective board: Building individual and board success*. An Institute of Directors Publication, Great Britain
- Baliga, B.R., Moyer, C.R., & Ramesh, S.R. (1996). CEO duality and firm performance: what's the fuss? *Strategic Management Journal*, 17, 41–53.
- Barnhart, S.W. & Roseinstein, S. (1998). Board composition, managerial ownership, and firm performance: an empirical analysis. *The Financial Review*, 33, 1-16.
- Baysinger, B. D., Kosnik, R. H., & Turk, T. A. (1991). Effects of board and ownership structure on corporate R&D strategy. *Academy of Management Journal* 34, 205-214.
- Beverley, J. & Shireenjit, J. (2009). Board structure and firm performance: Evidence from India's Top Companies. *Corporate Governance: An International Review*, 17, 492–509.
- Bennedsen, M., Kongsted, H. C., & Nielsen, K. M. (2004). Board size effects in closely held corporations. *Working Papers, CAM Institute of Economics, University of Copenhagen*
- Bennedsen, M., Kongsted, H.C., & Nielsen, K.M. (2008). The causal effect of board size in the performance of small and medium-sized firms. *Journal of Banking and Finance*, 32, 1098-1109.
- Bhagat, S. & Bernard, B. (2002). The non-correlation between board independence and long term firm performance. *Journal of Corporation Law*, 27, 231-274.
- Boyd, K.B. (1995). CEO duality and firm performance: a contingency model. *Strategic Management Journal* , 16, 301–312.
- Conger, J. A., Lawler, E.E., & Finegold, D. (2001). *Corporate Boards: New Strategies for Adding Value at the Top*. John Wiley and Sons, Inc. San Francisco

## BOARD STRUCTURE AND CORPORATE PERFORMANCE: TRADITIONAL VS. CONTEMPORARY APPROACH

---

- Chia-Wei Chen, J. Barry Lin, & Bingsheng Yi (2008). CEO duality and firm performance: an endogenous issue. *Corporate Ownership & Control*, 6, 58-65.
- Cheng, S., Evans, J.H., & Nagarajan, N.J. (2008). Board size and firm performance: the moderating effects of the market for corporate control. *Review of Quantitative Financial Accounting*, 31, 121-145.
- Daily, C. M. & Johnson, J. L. (1997). Sources of CEO power and firm financial performance: a longitudinal assessment. *Journal of Management*, 23, 97-117.
- Dalton, D. R., Daily, C. M., Ellstrand, A. E., & Johnson, J. L. (1998). Meta-analytic reviews of board composition, leadership structure, and financial performance. *Strategic Management Journal*, 19, 269-290.
- Dalton, D.R., Daily, C.M., Johnson, J.L., & Ellstrand, A.E. (1999). Number of directors and financial performance: a meta-analysis. *Academy of Management Journal*, 42, 674-686.
- Cadbury, Sir Adrian (1992). *Report of the Committee on the Financial Aspects of Corporate Governance*, Gee and Co. Ltd., London
- Coles, J. L., Daniel, N. D., & Naveen, L. (2008). Boards: Does one size fit all? *Journal of Financial Economics*, 87, 329-356.
- Combined Code (2008). *The Combined Code on Corporate Governance*. Financial Reporting Council, London
- Daily, C. M. & Dalton, D. R. (1992). The relationship between governance structure and corporate performance in entrepreneurial firms. *Journal of Business Venturing*, 7, 375-386.
- Daily, C. M. & Dalton, D. R. (1993). Board of directors leadership and structure: Control and performance implications. *Entrepreneurship Theory and Practice*, 17, 65-81.
- Daily, C. M. & Dalton, D.R. (1994). Bankruptcy and corporate governance: The impact of board composition and structure. *Academy of Management Journal*, 37, 1603-1617.
- Dalton, C.M. & Dalton, D.R. (2005). Boards of directors: utilizing empirical evidence in developing practical prescriptions. *British Journal of Management*, 16, 91-97.
- Dalton, D. R., Daily, C. M., Ellstrand, A. E., & Johnson, J. L. (1998). Meta-analytic reviews of board composition, leadership structure, and financial performance. *Strategic Management Journal*, 19, 269-290.
- Davis, J. H., Schoorman, D. F., & Donaldson, L. (1997). Toward a stewardship theory of management. *Academy of Management Review*, 22, 20-47.
- Duchin, R., Matsusaka, J. & Ozbas, O. (2010). When are outside directors effective? *Journal of Financial Economics*, 96, 195-214.
- Eisenberg, T., Sundgren, S., & Wells, M.T. (1998). Larger board size and decreasing firm performance: an empirical analysis. *The Financial Review*, 33, 1-16.
- Goodstein, J. & Boeker, W. (1991). Turbulence at the top: A new perspective on governance structure changes and strategic change. *Academy of Management Journal*, 34, 306-30.
- Guest, P. M. (2009). The impact of board size on firm performance: evidence from the UK. *The European Journal of Finance*, 15, 385-404.
- Hermalin, B.E. & Weisbach, M. S. (2003). Board of directors as an endogenously determined institution: A survey of the economic. *Working Paper Series*, Center for Responsible Business, UC Berkeley <http://escholarship.org/uc/item/7tm3j0hp>
- Jensen, M.C. (1993). The modern industrial revolution, exit and failure of internal control systems. *The Journal of Finance*, 48, 831-880.
- Johnson, J. L., Daily, C. M., & Ellstrand, A. E. (1996). Boards of directors: a review and research agenda. *Journal of Management*, 22, 409-438.
- Judge, W.Q. & Zeithaml, C. P. (1992). Institutional and strategic choice perspectives on board involvement in the strategic decision process. *Academy of Management Journal*, 35, 766-794.
- Kesner, I.F. & Johnson, R.B. (1990). An investigation of the relationship between board composition and stockholder suits. *Strategic Management Journal*, 11, 327-336.
- Kiel, G.C. & Nicholson G.J. (2003). Board composition and corporate performance: How the Australian experience informs contrasting theories of corporate governance. *Corporate Governance*, 11, 189-205.
- Larcker, D. & Tayan, B. (2011). *Corporate Governance Matters: A Closer Look at Organizational Choices and Their Consequences*. Pearson Education, Inc., New Jersey
- Leblanc, R. & Gillies, J. (2005). *Inside the boardroom*. Canada: John Wiley and Sons.

- Levrau, A. & Van den Berghe, L. (2007a). Corporate governance and board effectiveness: Beyond formalism. *Vlerick Leuven Gent Working Paper Series 2007/3*.
- Levrau, A. & Van den Berghe, L. (2007b). Identifying key determinants of effective boards of directors. *Vlerick Leuven Gent Working Paper Series 2007/11*.
- Lipton, M. & Lorsch, J.W. (1992). A modest proposal for improved corporate governance. *Business Lawyer*, 48, 59-77.
- Mallin, C.A. (2010). *Corporate Governance*. Oxford University Press, Inc., New York
- Monks, R. & Minow, N. (2002). *Corporate Governance*. Oxford: Blackwell Publishing.
- Nikolić, J. & Erić, J. (2011). Ključni faktori efektivnosti upravnog odbora. *Poslovna Ekonomija*, 2, 213-229.
- OECD (2004). *Principles of Corporate Governance*. OECD Publication Service, Paris
- Ongore, V.O. & K'Obonyo, K.O. (2011). Effects of selected corporate governance characteristics on firm performance: Empirical evidence from Kenya. *International Journal of Economics and Financial Issues*, 1, 99-122.
- Rechner, P. L. & Dalton, D. R. (1991). CEO duality and organizational performance: A longitudinal analysis. *Strategic Management Journal*, 12, 155-161.
- Roberts, J., McNulty, T., & Stiles, P. (2005). Beyond Agency conceptions of the work of the non-executive director: Creating accountability in the boardroom. *British Journal of Management*, 16, Special Issue, S5-S26.
- Rosenstein, S. & Wyatt, J. (1990). Outside directors, board independence and shareholder wealth. *Journal of Financial Economics*, 26, 175-191.
- Shakir, R. (2008). Board size, board composition and property firm performance. *Pacific Rim Property Research Journal*, 16, 1-16.
- Topac, S.M. (2011). The Effect of Board Size on Firm Performance: Evidence from Turkey. *Middle Eastern Finance and Economics*, 14, 119-127.
- Tricker, B. (2009). *Corporate Governance: Principles, Policies and Practices*. Oxford University Press, Inc., New York.
- Vafeas, N. (2000). Board Structure and the Informativeness of Earnings'. *Journal of Accounting and Public Policy*, 19, 139-160.
- Yermack, D. (1996). Higher valuation of companies with a small board of directors. *Journal of Financial Economics*, 40, 185-212.
- Zahra, S. A. & Pearce, J. A. (1989). Boards of directors and corporate financial performance: a review and integrative model. *Journal of Management*, 15, 291-334.



# CULTURAL INFLUENCES ON REWARD SYSTEM IN ORGANIZATIONS

Dušan Mojić<sup>1</sup>

**Abstract:** *The relationship between national cultural values and reward system in organizations have been analyzed in the paper. It is revealed that the choice of reward principle (equity, equality or need) is, to a large extent, determined by cultural factors. Individualism / collectivism dimension has been emphasized as the most important in that respect. Finally, it is possible to identify two cultural patterns or clusters, which are suitable for the creation of two different reward systems in organizations – a system based on equity principle and a system based on equality principle.*

**Keywords:** *organizations, national culture, reward system*

## Introduction

The importance and relevance of cultural factors in designing structures, systems and processes in organizations have been widely recognized in the theory and research of management and organization in the last few decades. Significant part of these analyses has been devoted to impact of cultural values and norms on designing and functioning of the reward or compensation system. Main goal of this paper is to present the most important theoretical and empirical contributions in that respect and to point to some possible research and practical implications of these findings.

Reward system in organizations represents a part of wider field of study – Human Resource Management – HRM, which itself is a part of organizational science dealing with all aspects of the employment in an organization (Peković et al. 2006). HRM in organizations usually includes following activities: workforce planning, recruitment and selection, education and training, performance appraisal and compensation, career development, etc. (Janićijević, 2004). According to Bratton and Gold (1999), HRM activities can be classified into the following five functional areas:

1. Staffing;
2. Rewards;
3. Employee development;
4. Employee maintenance;
5. Employee relations.

Employee reward system is definitely the most often perceived element of the HRM system, because it has the utmost importance for the employees to whom it refers to, but also for the managers who apply it. The reward system defines, among others, the financial rewards as one the most important motivational factor in an organization. As for the managerial point of view, the compensation system is the single most important means for influencing the employee behavior.

Reward system in its narrow sense includes money, goods, status and/or services provided by the employer to employees in exchange for the work performed. In its wider sense, reward system can include performance appraisal system, which has not only developmental purpose, but also an important role in determining the level of salaries, bonuses and similar reward schemes.

---

<sup>1</sup> Faculty of Philosophy, University of Belgrade, dmojic@f.bg.ac.rs

Compensation system consists of two types of rewards: financial and non-financial. Financial rewards refer to salary system (including direct and indirect rewards). Non-financial rewards are respect, performing a challenging job, status, personal development opportunities, etc. These are all, as we can see, psychological rewards for the employees in their workplaces (Bogićević, Milikić, 2008).

### Culture and reward system

Compensation in organizations, along with motivation and performance appraisal, represents one of three mostly studied areas of HRM in intercultural management (Janićijević, 2004). Generally, variations in these and other aspects of HRM in organizations in different societies have been mostly explained by cultural, but also by institutional factors. Namely, it is rightfully argued that cultural explanation itself is not enough, and institutional factors influencing HRM in organizations such as political, economic and legal system, tradition of industrial relations, organization and overall influence of trade unions and similar factors must be taken into account (Sparrow et al. 2004).

However, the majority of authors argue that the way in which the rewards have been allocated in organizations is dominantly determined by cultural values and norms (Schuler, Rogovsky, 1998; Hofstede, 2001; Tosi, Greckhamer, 2004). Earley and Erez (1997) remind that “mechanical” transfer of reward system into another culture can result in its failure and, finally, in total rejection of culturally “inappropriate” principles and practice.

Generally, employees can be rewarded based on their results (*principle of equity*), equally (*principle of equality*), or based on their needs (*principle of need*). These principles are often called also the principles of distributive justice. Huo and Steers (1993) concluded that there is a significant empirical support for the claim that culture plays an important role in deciding who will get rewards in organizations and what kind of rewards it will be. In their opinion, culture can influence the compensation system in three ways:

1. By determining what is considered to be important and valuable for employees;
2. By defining the way in which motivation and performance are analyzed or evaluated;
3. By pointing at possible (culturally appropriate) solutions for problems of motivation, available for managers in organizations.

Comparative studies of reward systems in different cultures have been mainly focused on three key questions:

- Overall level of rewards;
- Reward structure (ratio of financial and non-financial rewards);
- Types or forms of rewards (combination of direct and indirect salaries) (Sparrow, 1999).

Although Geert Hofstede’s contribution in studying the impact of national culture on most processes, structures and systems in organizations is widely recognized and well-known, here it is most appreciated. There is almost no serious research about the relationship between cultural factors and reward system without some reliance on Hofstede’s model (Gomez-Mejia, Welbourne, 1991; Schuler, Rogovsky, 1998; etc).

When speaking about particular dimensions of national culture, most attention have been devoted to the relationship between individualism/collectivism and rewards in organizations. Generally, studies mainly point at the use of equity principle in individualistic cultures and principle of equality in collectivistic cultures. Individualistic cultures value competition, achievement and personal goals and, therefore, promote principle of reward that recognizes and values individual contributions. On the other side, collectivistic cultures emphasize cooperation, interdependence and



group goals and, because of that, prefer compensation systems that support and maintain group harmony (Aguinis, Henle, 2003). However, it is important to remind on the fact that collectivistic cultures differentiate among so-called *in-group* members (members of primary groups) and so-called *out-group* members (members of “outside” groups), applying the principle of equality on *in-group* members, and the equity principle on *out-group* members (Leung, Bond, 1984).

US companies prefer reward systems based on the equity principle, as the best way to motivate employees, while more collectivistic cultures such as Japan, South Korea and Taiwan reject this principle almost completely (Steers, Sánchez-Runde, 2002). Empirical findings also supported the hypothesis that, for example, Swedish collectivistic orientation would result in the choice of equality-based reward principle, while US individualistic orientation will favor *equity-based* principle of compensation. Cultural dimension of individualism/collectivism acts as a moderating variable in determining the preferences of reward allocation (Earley, Singh, 1995).

Brown and Reich (1997) showed that US companies introduce reward system based on individual performance (because of the dominant individualistic values), while Japanese companies mostly favor seniority principle (rewarding long-term employed and older members), as one aspect of collectivism. It is interesting that attempts to introduce compensation systems based on individual performance (as in Western culture) increased overall expenses of workforce. Namely, companies with such schemes could not reduce salaries of less productive workers (in order to “save their face”). Group harmony (*wa*) would be also violated, so salaries were increased for all employees and new compensation scheme showed to be culturally inappropriate, and therefore unsuccessful.

Study of students’ attitudes from USA, Japan and South Korea (Kim et al. 1990) revealed, however, that equity reward principle can be traced in all three cultures, but with different strengths. Individualism influences such differences, although Japan (with significantly lower score compared to USA on this dimension) was not so distant in that respect. The authors argue that “masculinity/femininity” dimension moderates the above-mentioned influence of individualism and collectivism in Japan. Generally, in collectivistic cultures people tend to believe that too much reward differentiation should be avoided in organizations in order to keep the harmony of in-group relations. However, in Japan, strong achievement orientation and strive for business success can explain similar reward attitudes of Japanese and US students.

Systems of individual rewards in US companies tend to make clear connection between compensation and corporate financial success, by emphasizing the importance of personal results. In other cultures, the principle of equality is more appropriate, promoting compensation based on group effort and performance. The relationship between principles of distributional justice and culture is very important, particularly regarding individualism/collectivism dimension. For example, one US based multinational company failed to introduce individually based compensation system in its Danish subsidiary because local employees refused to accept such differentiation between different groups in organization. Strong egalitarian values led members of this subsidiary to opt for equal rewards instead for increased individual bonuses (Steers, Sánchez-Runde, 2002).

Also, it is often argued that in individualistic cultures the relationship between an individual and an organization is rational and calculative, founded on a contract. Because of that, in such cultures there is a strong preference towards the equity principle. In collectivistic cultures, on the other side, an organization is seen as a family and relationship between individual and collective is emotional and ethical, favoring the use of equality principle in reward allocation. Nevertheless, as already mentioned, the equality principle in collectivistic cultures is valid only for *in-group* members, while rewards to *out-group* members are distributed also according to equity principle.

Most important needs in individualistic cultures are material needs and needs for achievement, so most important rewards are based on financial incentives and possibilities for self-improvement and advancement. In collectivistic cultures, needs for security and relatedness are the most prominent, and

## **CULTURAL INFLUENCES ON REWARD SYSTEM IN ORGANIZATIONS**

---

compensation system should take this fact into account. Individualistic cultural values are compatible with formalized performance appraisal system (based on evaluation of individual performance). Therefore, performance appraisal system and management by objectives (MBO) are most commonly found in individualistic cultures.

On the other side, in collectivistic cultures there is a strong resistance towards individually based performance evaluation, making the use of formalized performance appraisal system and management by objectives almost impossible. The main reason is the concept of “saving face”, very common in collectivistic cultures, stating that explicit and public evaluation of individual performance of the organizational member endangers the group cohesion, and it is therefore unacceptable.

Similarly, in cultures with strong individualism rewards are mainly based on individual performance, while in collectivistic cultures seniority, formal education and skills, etc. are more appreciated. More developed reward schemes, such as pay for performance can be found predominantly in individualistic cultures, as well as individual bonuses and variable pay. Contrary to that, far more often group or team incentives can be found in collectivistic cultures, together with more important and more often various forms of non-financial incentives such as child care, organized transportation, etc. (Janićjević, 2004).

Power distance also significantly influences reward system in organizations. This cultural dimension informs us about the extent in which is unequal distribution of power expected and accepted in one culture. The same stands for an unequal reward distribution in organizations and its cultural justification. In another words, the salary span should be larger in cultures with stronger power distance. The same logic is valid for some benefits (status symbols), for example, separate parking spaces for managers (one of the strongest manifestations of US national culture in companies).

Gomez-Mejia and Welbourne (1991) state that in cultures with stronger power distance hierarchical compensation systems are more appropriate, with bigger salary span, reflecting status differences between managers and subordinates. On the other side, cultures with weaker power distance are convenient for more egalitarian reward systems, with smaller salary span and group distribution of financial incentives.

Uncertainty avoidance determines culturally desirable and acceptable level of uncertainty and risk that is built in compensation system. Stronger uncertainty avoidance in national culture implies lower risk (variability in pay) for majority of employees. Aside for an emphasis on fixed pay, these systems are also characterized by strong centralization and orientation towards internal organizational justice.

Contrary, in cultures with weaker uncertainty avoidance, larger portion of salaries can be variable, compared to cultures with stronger uncertainty avoidance (Schuler, Rogovsky, 1998). In such systems variable part of a salary is a key element in reward system, which is generally more decentralized and flexible and much more oriented toward external justice (Gomez-Mejia, Welbourne, 1991).

In accordance to this, pay for performance schemes are more often in cultures with weaker uncertainty avoidance, while reward systems based on seniority, formal qualifications and skills are more common for cultures with stronger uncertainty avoidance. Similarly, bonuses and provisions as reward forms are more frequent in former than in latter cultures. As for managerial reward systems, weaker uncertainty avoidance culturally favors higher share of bonuses in their overall salaries. Non-financial benefits are more important and more often in cultures with stronger uncertainty avoidance than in cultures with weaker uncertainty avoidance (Janićjević, 2004).

Pennings (1993) showed that more risk oriented US managers were often ready to accept total variability of their salaries, while European managers agreed to only 10% variability of financial rewards. In similar vein, cultural differences also influence preferences of financial and non-financial

rewards. Schneider and Barsoux (1997) revealed that employees in Sweden tend to choose free time over additional income (although high taxes might also influence this choice), while Japanese workers prefer financial rewards (with almost complete orientation toward group-based performance and incentives).

Employees in Japanese organizations tend to use only half of their sixteen days of holiday they are entitled to (compared to thirty five days in France and Germany). Namely, using all holiday days could be understood as lack of commitment to a group and workers who do so or refuse to work overtime have often been labeled as selfish (*wagamama*). As a consequence, *karoshi* (death caused by too exhausting work) is a very serious problem of the whole Japanese society, while, on the other side, people from Sweden consider free time an important part of their rights to healthy and happy life.

Finally, last dimension of national culture, “masculine/feminine” values influence reward system in organizations by emphasizing different types of gains/rewards. In “masculine” cultures the focus is on achievement (“confirmed” by salary, but also by advancement and challenging job), while in “feminine” cultures job security, good relationships between organizational members and overall quality of life have been emphasized.

Strong focus on achievement of “masculine” cultures implies result as a principle of distributive justice, unlike “feminine” cultures, who emphasize the principle or norm of equality. Therefore, the former cultures are more suitable for merit pay system, while the latter are more oriented toward various forms of indirect rewards or benefits. One of the empirically best supported research hypothesis is about the connection between strong “masculine” values and rare presence of various flexible benefits such as child care at workplace, career-break schemes and maternity leaves (Schuler, Rogovsky, 1998).

Dominant “masculine” values are also congruent with higher variability of salaries (especially for managerial bonuses). Such cultural orientation also implies sharper divide of gender roles, making differences in salaries of men and women more acceptable than in “feminine” culture. “Masculine” cultures are more convenient for systems of individual performance appraisal, as well as pay for performance schemes. As for “feminine” cultures (which emphasize the importance of overall quality of life), individual result is less important as a criterion of personal evaluation and it is inseparable from the personality itself, reducing that way the possibility for application of the performance appraisal system (Janićijević, 2004).

The analysis presented in the paper showed certain similarity of the influences of some cultural dimensions on reward system in organizations. Collectivism, strong uncertainty avoidance and “feminine” values are culturally congruent with preference of equality principle in organizations (based on seniority, formal qualifications or education). On the other hand, individualistic cultures, cultures with weak uncertainty avoidance and “masculine” values favor the use of compensation system based on individual results or performance. The same stands for the share of variable part of salaries, being much bigger in former than latter cultures.

Nevertheless, when studying the relationship between national culture and organizational systems, structures and processes, it is always plausible to remind on the necessity of system or holistic approach, i.e. viewing national culture as a system of assumptions and values rather than a simple grouping of particular dimensions. In that respect we can recognize two patterns (in Max Weber’s terminology “ideal types”) of cultural impact on the design of compensation system in organizations.

Cultural pattern A includes low power distance and uncertainty avoidance, strong individualism and mainly “masculine” values. The impact of these cultural orientations is very similar. Namely, most important needs in this cultural pattern are material needs and needs for achievement, and therefore, most important rewards are financial, as well as advancement possibilities. The basic principle of distributive justice is the equity principle. Performance appraisal system is individual,

formal and clear. The share of variable in overall salary is very high, especially for managers. Individually based incentives are prevailing, with less present non-financial employee benefits.

Cultural pattern B has high power distance and uncertainty avoidance, collectivism and mainly “feminine” values. Security needs and relatedness are far more emphasized. The reward system is built based on the equality principle, informal, group and implicit performance evaluation. Variable pay depends on seniority or group performance, education and skills, being merely a minor part of the overall salary, with strong emphasis on non-financial employee benefits (Janićijević, 2004).

Cultural pattern A is most similar to Anglo-Saxon and, less, Scandinavian national cultures, while cultural pattern B is close to some cultures of Latin America (Venezuela, Columbia), but also Serbian national culture and cultures of former Yugoslav republics (all of the latter classified by Hofstede in the same cultural cluster). However, it have to be mentioned that majority of national cultures cannot be classified into these two clusters and, because of that, we need to carefully examine the interrelationship of all cultural dimensions and their synergetic impacts on the design of reward system in organizations.

### **Implications for research and business practice**

Based on the presented analysis of the cultural influences on the compensation system in organizations, we can point at some practical recommendations for further theoretic and empirical studies and functioning of companies.

First, remainder about the culturally-bounded concepts and theories of management and organization is very important in this analysis for researchers, but also for practitioners (managers). Namely, an implicit and explicit emphasis on the crucial importance of financial rewards comes from the most influential cultural orientation in contemporary capitalism – Western (particularly Anglo-Saxon), in spite of an increasing support to a view that the principles of distributive justice (including the reward system in general) in organizations are to a great extent determined by the characteristics of national culture.

Second, it has already been mentioned in the paper that the impact of cultural dimension of individualism/collectivism on compensation system has been mainly emphasized. Therefore, we must particularly have in mind research findings revealing that the equity principle is most common in individualistic cultures, while equality principle is congruent with collectivistic cultural values. Of course, it must not be forgotten that collectivistic cultures often differentiate *in-group* members (for whom the principle of equality is applied) and *out-group* members (who are rewarded based on their results or equity principle).

Third, one of the most important issues in reward system is the ratio of fixed and variable pay in financial rewards. In cultures with high uncertainty avoidance variability in salaries is smaller and vice versa, but other cultural dimensions have also considerable impact. Individualism and “masculine” values are congruent with higher degree of variable pay, while collectivism and “feminine” orientations are culturally more appropriate for higher share of fixed salary.

Fourth, in contemporary sphere of work especially important issue is “reconciliation” of private/family and professional life, which reflects on the reward system in organizations. Namely, in “masculine” cultures (with similar impact of individualism), the emphasis is more on financial rewards and promotion opportunities than on various employee benefits linked to overall quality of life (different forms of insurance, flexible work hours, etc). Of course, it is just the opposite in cultures with dominant “feminine” values (and collectivism), with primary concern for the quality of life (along with already mentioned aspects, it includes child care, “career brake schemes” and so on).

Finally, system or holistic approach in the analysis of the influence of national culture on compensation system is here much easier in comparison to its impact on other organizational systems, structures and processes. We have in mind already mentioned finding that some cultural dimensions have similar impact in that respect. This makes the analysis less complex, but along with the warning that these cultural clusters or patterns are just “ideal types”, not that often found in reality (majority of cultures of the world cannot be classified into these clusters).

### **References**

- Aguinis, H. and C. A. Henle (2003). The Search for Universals in Cross-Cultural Organizational Behavior. In: *Organizational Behavior: The State of the Science* (Greenberg, J., Ed.). Second Edition, Mahwah, NJ; London: Lawrence Erlbaum Associates, 373-419.
- Bogićević Milikić, B. (2008). *Menadžment ljudskih resursa*. Četvrto izdanje. Beograd: Ekonomski fakultet.
- Bratton, J. and J. Gold (1999). *Human Resource Management: Theory and Practice*. Second Edition. Mahwah, NJ: Macmillan Business.
- Brown, C. and M. Reich (1997). Micro-Macro Linkages in High-Performance Employment Systems. *Organization Studies*, 18, 5, 765-781.
- Earley, C. P. and M. Erez (1997). *The Transplanted Executive: Why You Need to Understand How Workers in Other Countries See the World Differently*. Oxford: Oxford University Press.
- Earley, P. C. and H. Singh (1995). International and Intercultural Management Research: What's Next? *Academy of Management Journal*, 38, 2, 327-340.
- Gomez-Mejia, L. R. and T. Welbourne (1991). Compensation Strategies in a Global Context. *Human Resource Planning*, 14, 1, 29-41.
- Hofstede, G. (2001). *Culture's Consequences: Comparing Values, Behaviors, Institutions, and Organizations across Nations*. Thousand Oaks, CA: SAGE Publications.
- Huo, Y. P. and R. M. Steers (1993). Cultural Influences on the Design of Incentive Systems: The Case of East Asia. *Asia Pacific Journal of Management*, 10, 1, 71-85.
- Janićijević, N. (2008) *Organizaciono ponašanje*. Beograd: Data status.
- Janićijević, N. (2004). Specifičnosti ocene učinaka i kompenzacije zaposlenih u preduzećima Srbije. *Poslovna politika*, 33, 5, 47-52.
- Kim, K. I. et al. (1990). Reward Allocations in the United States, Japan, and Korea: A Comparison of Individualistic and Collectivistic Cultures. *Academy of Management Journal*, 33, 1, 188-198.
- Leung, K. and M. H. Bond (1984). The Impact of Cultural Collectivism on Reward Allocation. *The Journal of Personality and Social Psychology*, 47, 4, 793-804.
- Pennings, J. M. (1993). Executive Reward Systems: A Cross-National Comparison. *Journal of Management Studies*, 30, 2, 261-280.
- Petković, M. et al. (2006). *Organizacija: dizajn, ponašanje, ljudski resursi, promene*, 4. izmenjeno i dopunjeno izdanje, Beograd: Centar za izdavačku delatnost Ekonomskog fakulteta.
- Schneider, S. C. and J.-L. Barsoux, (1997). *Managing across Cultures*. New York: Prentice Hall.
- Schuler, R. S. and N. Rogovsky (1998). Understanding Compensation Practice Variations across Firms: The Impact of National Culture. *Journal of International Business Studies*, 29, 1, 159-177.
- Sparrow, P. R. (1999). International Rewards Systems: To Converge or not to Converge? In: *International HRM: Contemporary Issues in Europe* (C. Brewster and H. Harris, Eds.) London: Routledge, 102-119.
- Sparrow, P. R. et al. (2004). *Globalizing Human Resource Management*, London: Routledge.
- Steers, R. M. and C. J. Sánchez-Runde (2002). Culture, Motivation, and Work Behavior. In: *The Blackwell Handbook of Cross-Cultural Management*. (M. Gannon and K. Newman, Eds.), Oxford: Blackwell Business, 190-216.
- Tosi, H. L. and T. Greckhamer (2004). Culture and CEO Compensation. *Organization Science*, 15, 6, 657-670.



# NEW FORMS OF INSTITUTIONAL ARRANGEMENTS: THE CASE OF RAPP ZASTAVA (NORWAY – SERBIA)

Momčilo Đorđević<sup>1</sup>

**Abstract:** *The subject of this work are, as mentioned in the title, the new forms of institutional arrangements for new business environment. The first part talks about the new business environment, the factors that lead to changes and their implications. The emphasis is on company business in international markets, and the selection of appropriate strategies of internationalization, which will be appropriate to this new business environment. There are many reasons that are discussed in this paper, and would rather indicate that partners from different countries to accept different strategies, rather than opting for a strategy of export, or a strategy of direct investments abroad. The paper discusses the value of various indirect internationalization strategy, which may be useful for those domestic companies that are in front of problem the choice of acceptable strategies of internationalization. In new forms of institutional arrangements, the focus is on possible relationship with other firms and organizations. An initial decision for a firm seeking growth is whether to do so using its own endeavors (organic growth) or to short-cut the growth process by some kind of institutional relationship with other firms. These can take many form, including licensing, franchise, joint venture, alliances, mergers and acquisition.*

*The important part of this paper refers to the business case of RAPPMARINE (Norway) and their entering strategy on the Serbian market.*

**Keywords:** *international marketing, licensing, franchising, strategic alliance, joint ventures, acquisitions*

## Introduction

The subject of the research in the paper „THE INTERNATIONAL BUSINESS STRATEGIES IN NEW COMPETITIVE SURROUNDING“, from the previous Conference (held on December 14, 2010), as it is mentioned in the title, was the strategies of company internationalisation in a new competitive surrounding. The part of the author’s empirical research was presented, that included 51 company from the Region „Sumadija and Pomoravlje“, which adopted some of the strategies of internationalisation. The research had the aim to, among other things, indicate the necessity of accepting certain strategy of internationalisation of a company. Moreover, on the basis of the frequency of accepting certain strategies of internationalisation, to establish the form (the way) of internationalisation, that are preferred by the companies of the Region „Sumadija and Pomoravlje“ (Djordjevic et al., 2012)

The paper for this Conference: "NEW FORMS OF INSTITUTIONAL ARRANGEMENTS, STUDY CASE: RAPP ZASTAVA (NORWAY - SERBIA)" is practically the continuation of that research. In the first part of the paper new business surrounding, factors and their implications that stipulated the changes, are being discussed. Choosing the appropriate strategy of internationalisation of a company for that new, business surrounding, is also the subject of the research of this paper. There are several of the theoretic models for choosing a strategy, where identification of the main strategic options that lead to realizing business aims is assumed. One of these options are the institutional strategies. In the focus of the institutional strategies there is a relation with other companies and organisations. Initial decision for a company is whether to rely on its own possibilities for growth (organic growth), or to choose some of the institutional arrangements with other

---

<sup>1</sup> Faculty of Economics, University of Kragujevac, mdjordjevic@kg.ac.rs

companies. This way implies different forms, including franchises, joint ventures, alliances, mergers, acquisitions (Wall, 2010).

In the paper is also presented a part of the research that refers to the „business case of RAPP MARINE GROUP company“, i.e. the way and reasons for their choice of the acquisition strategy on Serbian market. The aim of the research is, among other things, to perceive all the advantages, and the dangers (traps) of the acquisition strategy, that is adopted by this company in its business on the Serbian market.

It is started from the basic hypothesis that the accepting of the process of internationalisation is the necessity for national companies. Derived hypothesis is that the strategies of indirect internationalisation (from simple contracts on marketing cooperation, licences, to joint ventures and acquisitions), attractive, intermediate solution in relation to the strategies of export and uncertain and risky, independent investments abroad.

In the process of research of the internationalisation strategies of the companies in the Region „Sumadija and Pomoravlje“, combination of different qualitative research approaches has been used, with the domination of case study research. This paper is a part of a wider research, on the companies from the territories of Sumadija and Pomoravlje, which have adopted some of the strategies of internationalisation, including the company „RAPP/ZASTAVA“ (Djordjevic et al., 2012).

This research can be useful for those company managers who find themselves before the choice of some of the numerous, different strategies of internationalisation. Each company has its specific features, both from the aspect of internal and external surrounding. In that sense, the choice of the adequate internationalisation strategy in business, for the specific company, should be in accordance with, or the reflection of its internal and external surrounding. Empirical research of the behaviour of other companies in the choice of internationalisation strategies, is only useful experience, which has to be taken into consideration in making a decision.

### **Previous contributions**

„New forms of institutional arrangements“ belong to, or are developed within the strategies of indirect company internationalisation. There are numerous books and articles written on this subject. Well-known is the book „Cooperative strategy - successful applying through strategy alliances“ by the author Dussage (1999). The book consists of key subjects necessary for understanding of the importance of this strategy. Moreover, the author Mockler (1999) has written a well-known book „Multinational strategic alliances“, that consists of the instructions for understanding of the usage of different strategies of indirect internationalisation in multinational organisations.

It is also worth to mention the authors of the report of the Council held at the Institute for international management, in Belgrade, in 1992. In the Council, among other authors, very distinguishable paper had professor Momcilo Milisavljevic „Competitive advantage in international economy“, that is the result of the research on the macro-project „Strategies of companies in market economy“. Professor Milisavljevic has recognized the importance of this strategy for the realization of competitive advantage, which is the condition for the success on the market. There is no unique understanding in which factors the roots of gaining and losing competitive advantage should be looked for. Most often, as the important factors the following are specified: managing of the economy, managing of a company, the quality of the national strategy and the understanding of changes in the factors of success in international economy.

The quality of managers in companies is an important assumption for the realization of relatively permanent competitive advantage in certain branch of the economy. Management has to be long-term, not short-term oriented to accentuate the innovation of a product, process and marketing



methods, for accepting reasonable risks and to be prepared for business cooperation with companies from other countries, emphasizes professor Milisavljevic.

Porter (1990) also recognizes the importance of cooperation strategies with ino-partners for realization of competitive advantage. It is started from the assumption that the competition is dynamic and evolutive and that it is necessary to perceive the reasons why the companies in some national surroundings are prone to innovate rather than in others. The companies are the ones that can create and maintain competitive advantage. The role of the state is not to support directly non-efficient companies, but to do everything possible to improve basic factors of national competitive advantage.

Since countries do not compete on the international market, but the companies from these countries, the quality of the managers is an important assumption for the realization of relatively permanent competitive advantage in certain branch. Management has to be long-term oriented and prepared for, among other things, business cooperation with companies from other countries, i.e. for involving in international alliances.

Porter emphasizes that the strategies of cooperation among companies, that are located in different countries, are one of the ways to compete globally. Those companies participate in the activities of the value chain with partners on global level. The existence of larger number of contracts, and not just among the companies from developed countries, but with the companies from the developing countries, as well, can be ascertained. (Porter, 1990).

Prahalad C. (from the University of Michigan, USA) emphasizes that the future period will be marked by the growing role of partnership and alliances and their influence on competitive dynamics. These partnerships and alliances are not the repetition of traditional mutual investments in different industries. The intentions, expenses and risks of these new forms differ. This is a new, unexplored area, and at the same time a challenge for company managers to find new ways of competition, states Prahalad (Dussage and Garrette, 1999).

### **New competitive surrounding**

The evaluation of competent authors in the area of strategies is that, in the following decades, managers will be faced with rapidly changeable competitive surrounding. It is about new competitive surrounding whose characteristics are: sudden and abrupt changes, such as deregulation, globalisation, informational technology and Internet. These are at the same time new conditions of business that have to be appreciated. Managers will have to adopt new approach, for new conditions of business-to learn how to compete in different ways. One of the main areas (domains) of business, which offers the possibility for different competition is the area of partnership and alliances.

Prahalad (Dussage and Garrette, 1999) emphasizes that now there is „discontinuity of competitive surrounding“ as the consequence of the influence of key strategic factors:

- Fast technological changes
- Privatisation and deregulation
- Internet-based technologies
- Pressures of different groups (ecological, groups for protection of customers, etc)
- New forms of institutional arrangements with other companies.

These factors change the context of business strategy from the positioning of a company within clearly determined industrial structure, to expansion and shaping of that structure under the influence of personal initiative. In a new business surrounding, in contrast to a traditional one, a strategy has the

new roles in accordance with changed conditions, which are the consequence of the effects of key strategic factors.

In accordance with the subject of this paper, especially important is the influence of the forms of institutional arrangements with other companies. As it will be seen in the business example, as the consequence of the effects of key strategic factors, only within one of the internationalisation strategy different versions of acquisition have emerged (Lynch, 1989):

- One of the partners is buying joint venture,
- One of the partners is buying the other partner,
- Someone from the outside is buying joint venture.

„RAPP ZASTAVA“ is the version of acquisition where one, successful and financially powerful partner („RAPP MARINE GROUP“) is buying the other partner (who is in different problems and without enough finance).

### **The forms of institutional arrangements**

Large number of companies in contemporary economy do not have enough of their own resources to independently accomplish competitive advantage. The fact is that the international alliances of „capital coalitions“ for conducting successful strategies, that provide competitive advantage, are more and more present in global economy. The term alliance covers all the types of cooperation among companies in international economy, that are more than ordinary market transactions, and less than joining and merging of companies. All the types of partnerships, such as licences, cooperation and joint ventures, rank among company alliances (Milisavljevic, 1992).

In order for alliance to truly contribute to movement of competitive advantage for the benefit of a company, it is necessary a national base for branch competition to exist. This is the reason why, before entering of a company into alliance, it is necessary to estimate whether national base could be improved, by which the accomplishment of competitive advantage could be provided. There is an area, or the possibility for active role of the state in the contribution to the development of national base, which strengthens competitive position of a company on the international market. This, originally Porter's idea, is further developed into new thesis on the importance of national origin of a company-that competitive power (certain forms of international cooperation) is developed on the basis of comparative advantage of a country, from which the company originates.

In this new context, managers have to significantly adjust their managerial approach with the aim to use specific advantages that are offered by alliance. International strategic alliances can be observed as the means for usage of comparative advantages of involved countries, or the advantages that are specific for that country (Shan and Hamilton, 1991).

The wave of mergers and acquisitions has taken the time of 1980s, unfortunately with very unsatisfying results. According to many analysts even 80% of mergers and acquisitions was unsuccessful. The acquisitions show two types of defects. First, there are problems and difficulties of „integration“ with taken company, which have experienced certain traumas. Another problem with mergers and acquisitions is that all of the activities, properties, and other values of a bought company are not always involved. Unsatisfying results of functioning of many mergers and acquisitions are one of the reasons why international alliances are popular. Alliances enable avoidance of cultural and organisational shock, especially, if the mergers and acquisitions preceded. Alliances refer by the definition to the specific area of cooperation, which is most often specified by the contract. The extent

of cooperation can be widened gradually, but those activities, which are not interesting for the partners, can be excluded from the agreement.

One research of the functioning of international alliances has shown the following (Bleeke and Ernst, 1991):

1. Alliances are more efficient than mergers of foreign companies for new business activities and for new markets,
2. Alliances between strong and weak companies do not give good results,
3. It is better for the results of alliances to be above the initial aims and expectations,
4. Alliances between equally strong partners have greater success,
5. More than 75% of analyzed alliances have been concluded by merging of the weaker partner to the stronger one.

In the analysis of the results of this research it is pointed that, in choosing the strategy, two alternative strategies: alliance or merger (acquisition) should be considered in parallel.

### Strategies of indirect internationalisation

Strategies of indirect internationalization (from simple contracts on marketing cooperation, licenses and franchise to joint ventures and acquisitions), are often the choice strategies, since they represent attractive, neutral solution in relation to extremes (the strategy of export and uncertain and risky, independent investments abroad).

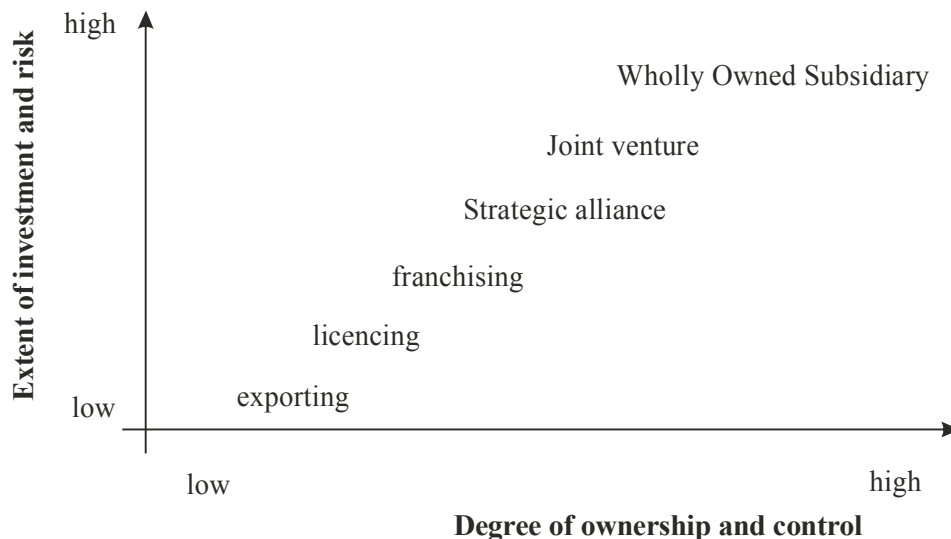

**Figure 1: Entry Modes for International Expansion,**

*Source: Dess, G. et al., 2004, Strategic Management-Creating Competitive Advantages, fifth edition, McGraw-Hill, Irwin, p. 259*

As it is shown in the picture, there are two extremes of the ways of international expansion. When we talk about one of the extremes, exporting strategy, one should have in mind the

## NEW FORMS OF INSTITUTIONAL ARRANGEMENTS: THE CASE OF RAPP ZASTAVA (NORWAY – SERBIA)

characteristics of this strategy approach: relatively small risk, significant expenses and limited control. The exporters have typically little control over marketing and the distribution of their products, high expenses of transport and customs, and different types of services they could pay to the distributors. The company does not receive information „at first hand“, which is very important, especially on the international markets, on which the products and services have to be adjusted to local tastes and preferences.

On the other hand, independent, „green field“ investments abroad are highly risky. As it was already pointed, the choice of the type of approach depends on many factors, but the analysis of the risk is one of the important ones. If the strong local presence is wanted, then the independent, „green field“ investments are a good way. But, it is necessary, in the process of deciding, to include the analysis of all the relevant risks (Kluyver and Pearce, 2003).

In support of the choice in favor of some of the forms of institutionalised strategies speaks the well-known fact as well, that competitive power (certain forms of institutional arrangement) is formed on the basis of comparative advantage of a country which the mentioned company comes from (Shan and Hamilton, 1991).

### Business case of the company „RAPP marine group“, (Norway)

In the process of the privatisation of national companies from Serbia, „RAPP MARINE GROUP“, from Norway, at the auction held on October 9, 2006 in Belgrade, has become majority owner (over 70% of shares) of the national company ZASTAVA MASINE from Kragujevac. This is a multinational company, that has its business offices all around the world. Basically, the production of this company includes two types of programe:

- The production of frames (cranes, „winches“) for ships and oil platforms
- The production of fire-protecting doors for ships.



Figure 2: the company RAPP MARINE

Source: Internal materials of the company, RAPP NEWS 2007.

In the company „RAPP –ZASTAVA“ in Kragujevac „winches“ for ships and oil platforms are produced and sold on the markets all around the world. Today, „RAPP-ZASTAVA“ is according to all the parametres a successful company. In Kragujevac „winches“ are produced for which there is demand on the markets all around the world, and the employees regularly receive their salaries, which are above the average. A very important thing is that there are plans for further development of the business.

**Acquisition „RAPP-ZASTAVA“**

The company „RAPP MARINE GROUP“ from Norway, has chosen, after detailed research of relevant factors, among others, potential and compatibility, to buy national company ZASTAVA MASINE from Kragujevac (one of several versions of the acquisition strategy).

„RAPP-ZASTAVA“ is the kind of acquisition where one, successful and financially powerful partner („RAPP MARINE GROUP“) is buying the other partner (which is in different problems and without enough finance).

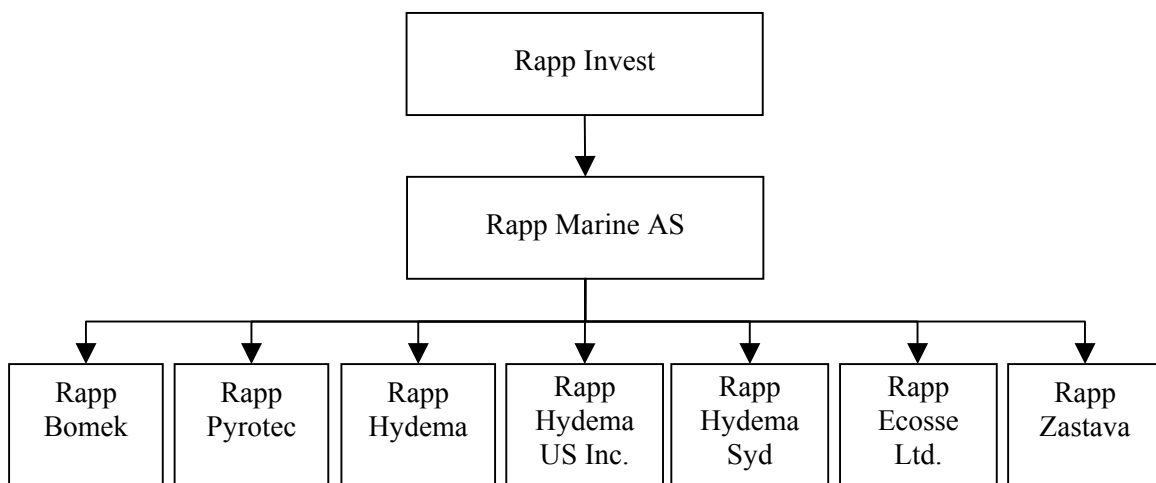

**Figure 3: Organization Chart, March 2012**

*Source: Internal materials of the company*

For „RAPP MARINE GROUP“, which in financial sense does not have problems, the acquisition of the company „ZASTAVA MASINE“ was a good strategic alternative. Apart from this, the acquisition was a reasonable option because the two companies are more similar than different. Namely, while considering potential and compatibility, „ZASTAVA MASINE“ had at their disposal about thirty machines. The evaluation of the Norwegian partner was that, with small modifications of the existing machines and the purchase of additional equipment, „ZASTAVA MASINE“ can be empowered for the production from the programe „RAPP MARINE GROUP“, („winches“ for the marine industry and fishing).



**Figure 4: „winch“ that is produced in the company „RAPP ZASTAVA“**

*Source: Internal materials of the company*

The representatives of the company „Rapp Marine Group“, prof. Dr Sverre Are Jensen (who is at the same time the president of the Managerial Board of the Company), and Tor S. Andersen (one of the owners of the Company), gave, by the invitation, the lecture on the company Rapp Marine and its strategy of the access on the Serbian market. The lecture was well visited by the students of the third and fourth year of the Faculty of Economics. After the held lecture, which was in English, the students gave their comments and asked the questions.

### **The project of socially responsible behaviour of the company „Rapp Marine Group“ in Serbia**

The proof that RAPP MARINE is the „right company“ that came into Serbia, is that by the purchase of the company ZASTAVA MASINE, they did not stop. Meetings and deals on the ways of broadening the cooperation have ensued. In 2010, Sverre Are Jensen, professor at BODDO GRADUATE SCHOOL OF BUSINESS and the president of RAPP MARINE GROUP, Slobodan Milovanovic, the president of RAPP ZASTAVA and professor Momcilo Djordjevic, from the Faculty of Economics, exchanged the ideas and made an arrangement about further ways of cooperation.

The plan for carrying out the cooperation between „Rapp Marine Group“, Nordland University and University of Kragujevac, is a good example of socially responsible behaviour of the company towards its „stakeholders“ (both the Norwegian and Serbian ones).

Norwegian part has provided complete financing of the Project of social responsibility, which was successfully implemented during 2011-2012.

### **The goals of the Project**

- Development of the local community in Kragujevac, Serbia (long-term goal),
- The contribution of the Project to the decreasing of the unemployment rate in Serbia. With this, the company RAPP MARINE has shown its interest in the community in which it is doing business.
- Employment of the trained staff (short-term and long-term goal),
- Since the Project includes important business aspects, including companies which actively participate, the possibility of successful employment of the students in these companies is an important goal.
- Increasing of the knowledge through international cooperation of the two Universities (short-term and long-term goal)
- This Project will also contribute to further development of the two Universities, considering the mutual research activities and the exchange of students and staff.
- The development of the University (short-term and long-term goal)
- Considering the possibility of acquiring knowledge between the two Universities, competence of the students within each University has been growing significantly. It is expected that the Universities will also profit due to this Project and advance as educating institutions.
- Strengthening of the friendship between the two countries (short-term and long-term goal)

In the focus of the Project is the connection between educative and business sector. For „RAPP ZASTAVA“ and „RAPP MARINE GROUP“, this project has an extreme importance. Several participants (from Norway and Serbia) has been included in the Project. It was the challenge of a kind for both countries and included companies and institutions.

The proposer of this Project has also received positive response from the Norwegian ambassador in Serbia, Haakon Blankenborg. The ambassador has supported the idea of this Project and Norwegian embassy included itself in its financing with significant capital.

The plan for implementation of the Project: the cooperation between Rapp Group, Nordland University and the University of Kragujevac began on October 6 and 7, 2011. Among other things, the Project also predicted the inclusion of 20 students of Master programe from the Faculty of Mechanical Engineering, and 5 student of Master programe from the Faculty of Economics, as well as the engagemet of the students in „intership“ programe, which is one of the main focuses of the Project.

The realization of the Project covered time period of 2011-2012. In this period four seminars for the students of Master studies, from the University of Kragujevac (from the Faculty of Economics and the Faculty of Mechanical Engineering) have been realized. The lectures were held by the professors from the University of Kragujevac, professors from Norway, as well as the experienced managers from the company „RAPP MARINE GROUP“.

The lectures in all the seminars were in English. Students had previously finished the course of English language (received adequate sertificates on the level of the acquired knowledge of English language), which was financed by the budget of the Project. Moreover, all the students had to pass practical part - practical training in the company „RAPP ZASTAVA“ in Kragujevac.

Finally, before final 4th semester all of the 25 students of master studies were on the professional practice in Norway, the USA, Scotland, where the parent company has its branches. The visit and professional practice in the branches of the company „RAPP MARINE GROUP“, judging by the words of students themselves, was priceless. That was a unique, important experience, not only in business, but in cultural sense, as well. Many of the students for the first time had the opportunity to

meet other surroundings, other cultures. For them, as future company managers, it is extremely important to develop and maintain global insight, or the orientation in their behaviour.

In order to surmount traditional, provincial aspects of the international business, companies and their managers have to have wider perspective of the one that means „only“ doing business inside their own borders. Global insight is necessary for managers that want to have certain role on the global scene – to possess shaped mental attitude that is characterized by tolerance and certain level of knowledge on international business management (Wild et al., 2003).

In that sense, this Project has had, judging by the words of participants, priceless value. The project was ended after finished fourth semester, which was held at the Faculty of Mechanical Engineering, in Kragujevac, in June 2012. At the same time, there are agreements of the project team about starting other, similar projects (joint programes for Master and Doctoral studies, special programe on rational usage of energy, protection of the environment, etc).

### **Conclusion**

This paper has had as its subject of the research the choice of the appropriate strategy of the internationalisation of a company, for a new business surrounding, whose characteristics are: sudden and abrupt changes, such as deregulation, globalisation, informational technology and Internet. Company managers will have to implement the new approach - for the new business conditions - to learn how to compete in different ways. One of the main areas of business, which offers the opportunity for different competing is the area of partnership and alliances.

In the focus of the institutional strategies is the relation with other companies and organizations. Initial decision for a company is whether to rely on its own possibilities of growth (organic growth) or to choose some of the institutional arrangements with other companies. Especially important is the influence of the new forms of institutional arrangements with other companies.

In the paper, among other things, is also presented the part of the research considering „business case of the company RAPP MARINE GROUP“, i. e. The way and reasons for choosing the acquisition strategy on Serbian market. Advantages and the dangers (traps) of the acquisition strategy are observed, which were implemented by the company, which was the goal of the research.

Great number of companies in Serbia, which have accepted some of the numerous strategies of internationalisation, certifies basic hypothesis of this paper. Moreover, what is also proved by the „business case of the company RAPP MARINE GROUP“, nderived hypothesis that strategies of indirect internationalisation, from simple contracts on marketing cooperation, licenses, to joint ventures and acquisitions are attractive, neutral solution in relation to strategies of export and uncertain and risky, independent investments abroad, is also certified.

This research can be useful for those company managers who are faced with some of the numerous, different strategies of internationalisation. Each company has its specific features, both from the aspect of internal and external surrounding. In that sense, the choice of adequate internationalisation strategy of business, for a specific company, should be in accordance with, or the reflection of its internal and external surrounding. Empirical research of the behaviour of other companies in the choice of internationalisation strategies, is only useful experience, which has to be taken into consideration while deciding.



## References

- Bleeke, P. and D. Ernst (1991). The Way to Win in Cross-Border Alliances. *Harvard Business Review*, novembar-december.
- Bradley, F. (1999), *International Marketing Strategy*. Third Edition. Prentice Hall Europe.
- Brandenburg M., (1986), *Free yourself from servitude*, Accountancy, New York
- Dess, G., Lumpkin, G. and A. Eisner (2004). *Strategic Management-Creating Competitive Advantages*, fifth edition. Irwin: McGraw-Hill.
- Djordjevic, M., Sagic, S. and V. Marinkovic (2012). How Companies Enter International Markets: Presentation and Analysis of the Empirical Research. *Актуални проблеми економики*. 7(133), 331-342.
- Dussage, P. and B. Garrette (1999). *Cooperative Strategy, Competing Successfully Through Strategic Alliances*. England: John Wiley & Sons, Ltd.
- Glaister K. (1991). *A Conversation with Michael Porter*, from A International Competitive Strategy Perspective European, *European Management Journal*, Vol. 9, no. 4.
- Glaister K. (1991). *International Success: Company Strategy and National Advantage*, *European Management Journal*, Vol. 9, No. 3.
- Gullander S. (1976). *Joint Ventures and Corporate Strategy*. Columbia Journal of World Business, New York
- Jepma C. and A. Rhoen (1996). *International Trade: A Business Perspective*. London-New York: The Dutch Open University, Longman.
- Kluyver, C. and J. Pearce (2003). *Strategy, A View From The Top*. New Jersey: Prentice Hall.
- Milislavljevic, M. (1992). Konkurentna prednost u međunarodnoj ekonomiji. Zbornik radova sa Naučne konferencije. Beograd: Institut za Internacionalni menadžment, 15-22.
- Mockler, R. (1999). *Multinational Strategic Alliances*. New York: John Wiley & Sons, Ltd.
- Porter, M. (1990). *The Competitive Advantage of Nations*. London: The Macmillan Press.
- RAPP (2010). *Welcome to The Rapp Marine Group*, Rapp Marine <http://rappmarine.com/>
- RAPP NEWS (2007). *Newsletter From Rapp Marine Group*, Rapp Marine AS, 8037, Bodo, Norge.
- Shan, W. and W. Hamilton (1991). Country-Specific Advantage and International Cooperation. *Strategic Management Journal*, 12, 419-432.
- Wall, S., Minocsha, S. and B. Rees (2010). *International Business*, Third Edition. New Jersey: Prentice Hall Pearson Education.
- Wild, J., Wild, K. and J. Han (2003). *International Business*, Second Edition. New Jersey: Pearson Education.
- Zahra, S. and G. Elhagrasey (1994). Strategic Management of International Joint Ventures, *European Management Journal*, No. 1.



# HEALTHCARE AND PROCUREMENT MANAGEMENT – ISSUES WITHIN THE SERBIAN MARKET

Slobodan Aćimović<sup>1</sup>

Veljko Mijušković<sup>2</sup>

**Abstract:** *Efficient healthcare management assumes adequate coordination of all relevant business functions. The focus of analysis is on quality procurement management, as a relevant source of competitive company advantage, regardless of its primary activity. The concentration on healthcare and procurement management is double justified: First, procurement optimization is not just an economic question in this sector, but a vital managerial segment for its key users-patients. Second, through procurement process we intend to show high correlation between individual functions on healthcare micro level and general sector organization, along with issues caused by mismanagement, analyzing the case of Serbia.*

*Following the stated logic, research is divided into two parts. The first considers the importance of company procurement management, emphasizing the specifics in healthcare. The second, using case study research method, analyses key issues of Serbian healthcare and consequences on procurement process. The research also offers a set of recommendations for problem diminishing/elimination in future.*

**Keywords:** *management, procurement, healthcare, corruption, Serbia*

## Instead of an introduction- the importance of company procurement management

There are various elements that need to be defined when we talk about specifics and importance of managing company procurement. Among the most important we focus on: **the role and function of company procurement, defining its character and finally its contribution to company business performance** (Aćimović and Mijušković, 2011).

Company procurement can potentially mean a source of competitive advantage, but it can also cause inefficiency. The existence of such extreme attitudes is caused by different treatment given to procurement by company management. If the management is less proactively oriented, and with traditional attitude not following the principles of modern market approach, than procurement is usually scattered, non-integrated and subject to some other business functions. In this case, the highest stadium is periodical grouping into **procurement process**. Unfortunately, even if grouping of activities into a process occurs, it is usually an incomplete and isolated exception.

Modern business concepts of company organization offer quite a different opinion about the way procurement should be positioned. First, it is necessary to create unified business processes, which are integrally given in one **business function**. Besides that, the importance of procurement for success of a company has already been recognized and is indisputable. The best confirmation of these claims are modern business models and concepts of activity organizing, where we primarily point out the **value chain concept**, created by leading American author in the field of management, Micheal Porter. The illustration of his concept is given in **figure 1**.

---

<sup>1</sup> Faculty of Economics, University of Belgrade

<sup>2</sup> Faculty of Economics, University of Belgrade, mijuskovic@ekof.bg.ac.rs

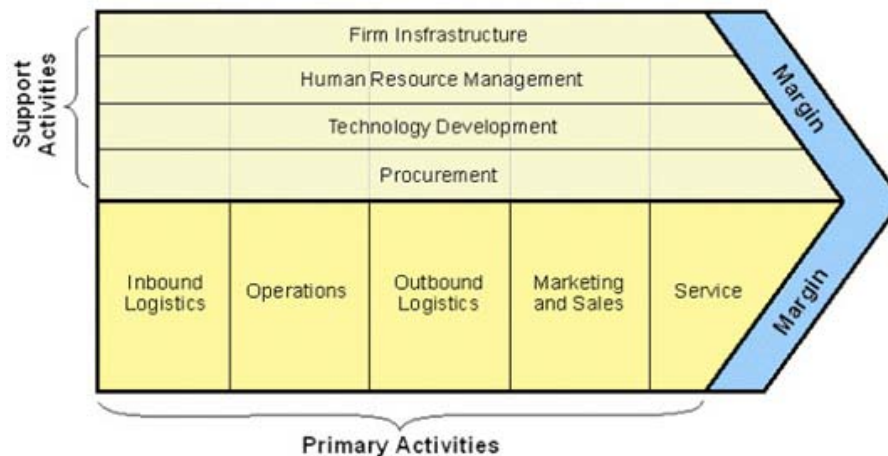

Figure 1. The value chain concept (Porter, 1985)

According to Value chain concept, Porter defines two groups of activities, unified into business functions (Porter, 1985):

- **Primary activities.** This group of activities contributes to creation of value within business processes and company functions. These activities should constantly be improved in order to increase the newly-formed value. From given illustration, we can see that within this category Porter identifies: inbound logistics, operations or process of production, outbound logistics, sales, marketing and post-sales activities (service).
- **Support activities.** This group of activities does not directly participate in the creation of value, but is practically a precondition of its creation. Namely, as a human organism could not function without spinal support, in the same manner, company value could not be created without support activities. In this group we identify: company infrastructure, human resources, technology development and procurement.

A short conceptual review of Porter's methodology is aimed to show that company procurement has not only significantly improved its position in modern business, but has gained one of the central places, as an infrastructural support in creating company value. Numerous practical examples, of which Dell computers is cited as a textbook example, only confirm the correctness of attitudes in demonstrated concept.

Analyzing the **character of procurement function**, we can say that it is multiple. First, strategic positioning and important decision making concerning procurement point out the importance of **marketing elements**. Namely, in carrying out business activities, earlier focus on strictly planning company sales is transferred on to the domain of procurement, since it is considered a pre-phase and an inseparable part of sales process. Putting it metaphorically, we are talking about «two sides of one medal». Therefore, the function of procurement, as well as all other business decisions connected with it, must be unified under the marketing strategy of a company, regardless of it dealing with production or service activities (Lovreta and Petković, 2010).

However, besides undisputed influence of marketing elements, scientific circles more and more argue and also stress the importance of the **logistic component** of procurement. Precisely, while strategic level defines procurement process and phases, its operationalization assumes adequate

logistic organization. Practically, the aim set by marketing function is carried out by logistic support. The given realization is carried out by optimizing subsystems which are part of the logistic management: supplies, warehousing, transport and information processing (Božić & Aćimović, 2012). Without pretenses to determine precise quantitative relation between logistic and marketing dimension of procurement character, we can conclude that the logistic component, as far as the activity operationalization is concerned, certainly has the prime edge.

Finally, when defining the **contribution of the procurement function** for a precise company, we can summarize previous analysis as a logical conclusion. Namely, if adequately organized, positioned and united, procurement function can be used as a tool for minimizing input company costs and achieving competitive advantage on that basis. Furthermore, a significant advantage of good procurement organization is a stronger negotiation position and better strategic approach towards business partners, as an external effect of implementation. Concluding, the procurement potential is seen in forming a base for creating internal company value, which has already been explained within the Porter model. The importance of this function is understood both in international, but also domestic relevant literature. If adequately used, the potential of this function can bring numerous benefits to many domestic companies, which is shown in detail in some of the authors' previous papers (Mijušković, 2011).

The scope of the paper refers to specifics of using modern management, and specially procurement management within the supply chain of healthcare institutions. The healthcare industry, as a very specific field of economy, up until recently, has only been concerned with the curing process, while modern management techniques were mostly neglected. Simply put, every healthcare institution should be managed both in medical but also economic sense, and that is why the savings aspect on the procurement side is credit worth. Paper focus is on assessment of possibilities of benchmarking quality solutions of developed western economies of organizing healthcare procurement onto Serbian healthcare sector. Therefore, the following three parts of the paper are dedicated to a concise review of chosen western practice of general and procurement management in healthcare sector, while the final two parts of the paper summarize the main issues of Serbian healthcare and potential solutions, seen from the managerial perspective.

### **The specifics of procurement management in healthcare**

It is justifiably expected for the healthcare sector of one economy (in the broadest sense speaking) to grow and participate more and more in the global GDP in the following few years. At the same time, deregulation of this sector and entrance of private capital has eliminated from the market many healthcare institutions due to uncontrolled variable costs and decreasing profits. This «radical turn in healthcare» is the result of increased price competition and regulatory environment of developed western economies. Experience of these countries show that only those participants of this sector, which are adequately prepared and use right management methods can expect to survive on the market. Within this part of the paper we analyze key trends in healthcare industry, relevant from the aspect of procurement management, as well as specific problems of this field which appear in every day functioning.

***Present global business trends in healthcare industry.*** Healthcare industry is in constant search for approved and used business techniques in order to improve its performance in many business areas. Goal of implementing processes based on principals of modern management is a direct consequence of using existing system of compensation, DRG system (Schreyogg et al., 2010) and increased competition. The most important healthcare supply chain management trend is the emphasized accent on efficiency and effectiveness. Within that general orientation, we can distinguish two key trends (Benton, 2010):

- Management and supply control by one major source or supplier;
- The automation of technological processes;

The main source of supply, assumes the majority of functions in supply chain department of some healthcare institution. There are numerous advantages to this arrangement, such as savings concerning labor force in hospitals, activity extent and supply level. Maybe the key element to success of these arrangements lies in the level and quality of communication and coordination between hospital departments and suppliers. External entity on supply side can facilitate and optimize problems concerning behavior since it is, by nature, objective and interested in offering high level of service.

There is no doubt that high technology represents a very important component in contemporary healthcare system. However, to be precise, the usage of high technology in healthcare is mainly connected to diagnose setting and illness treatment. Although the advancements in healthcare modern technology and sophisticated information systems usage are evident, they still achieve results of poorer quality compared to production and/or trade sector. Certain studies have shown that the trend of using these technologies is still uprising and that it will only have an upward path. A good example of these studies is the one analyzing the usage of bar code technology in pharmaceutical supplies management (Chester and Zilz, 1989). The results of using these technologies should lead to increased efficiency, lowering of total supply costs, improving space usage and lowering the needed level of supplies. The technology automation is implemented in all aspects of healthcare supply chain management, with the accent on optimizing the processes of procurement and supplies.

***Procurement issues specific to healthcare sector.*** Hospitals, as central constituents of the healthcare system, represent complex organizations which offer a variety of services to their patients, but also to medical and other staff. These services include catering, cleaning, pharmacology, laboratory analysis, surgery, radiology, administrative support and other services. Each of these services is connected to a different area, uses unique materials, and therefore is in need of procuring various inputs. That is why a complex procurement system is necessary, so that the right resources and materials would be acquired when needed, in the right quantity and on time. Operative hospital costs have become extremely important, since the already mentioned western system of compensation is not solely based on costs. In mid-eighties of the previous century, starting with USA, a specific DRG concept was implemented. According to this refund system, hospital financing is based on unified fee for determined patient diagnosis, regardless of the following costs (Davis and Rhodes, 1988). The essence of this concept is to limit hospital expenses, as key units in healthcare, and to encourage them to function efficiently and cost-effectively. Since adequate procurement management can be a source of numerous savings, the connectedness with this concept is completely justified. Of course, such a rational system is not equally globally accepted and implemented in practice.

Treating procurement as a process, we determine a great number of inputs and materials for hospital functioning which have the character of ***independent demand procurement units***. However, there are certain resources created within hospitals, characterized by dependent demand, while supplies supporting these resources are mostly raw materials in process of production. Hospital departments, accumulating supplies are copy centers, cafeterias, restaurants and pharmacies. In case of hospitals, but also complete healthcare sector, the ***key dilemma is to buy or rent certain resources***. The demand for some resources, and thus procurement procedure can be carried out according to surgical timetable. For example, a certain quantity of blood plasma of a special group, must be kept for safety reasons during those days when open hearth operations, or similar complicated procedures, are carried out.

***Concept and technology breakthroughs as good assistants in managing healthcare procurement.*** Basically, the issue of procurement management is mostly connected to solving the problem of inventory and its adequate optimization. Although the term is much broader than this aspect, the major line of activities precisely has to do with inventory management. Concepts and technologies developed to solve the inventory problem in general supply chain management (or shortly SCM), can be successfully applied to the healthcare sector, of course, regarding its area specifics. For example, concepts such as VMI, CPFR, and Flowcasting, which represent standard SCM tools are successfully implemented in the medical sector in certain countries, such as USA, and ease the procurement process (Lysons and Gillingham, 2006). Besides the usage of business concepts, technology advancements additionally improve many procurement activities in healthcare. One of the mostly used technologies when it comes to SCM, which also found its role in the healthcare sector is RFID (Raviprakash et al., 2009). The tracking technology of RFID allows the healthcare institutions to keep the best possible record and visibility of their inventory at all times, tuning the ordering and other administrative activities and decreasing the possibilities of any frauds and manipulations (Acharyulu, 2007). The extremely fast evolution possibilities brought by the internet modifies the up-coming technologies and concepts to fit the existing trends. Thus, the e-procurement idea, the basic concept upgraded to meet the new demands, has also started to be a part of the operations of healthcare sector procurement (Smith and Flanegin, 2004). From this short recapitulation we can see that both concept and technology innovations are significant factors of general SCM improvements, but also advances in particular industries, such as healthcare.

### **The procedure of organizing group procurement in healthcare**

A characteristic western, procurement solution in healthcare is an Organization for group procurement- OGP. The specifics of OGP lie in its intermediating between users and providers of healthcare services such as hospitals, nursing homes and other healthcare agencies, securing savings and improving efficiency of transactions. That is achieved by aggregating ordered resource quantities and using that "leverage" as a discount negotiation basis with producers, distributors and other salesmen. According to newer research, almost every hospital in USA (about 96-98%) opts for OGP contracts within their procurement functions. (Benton, 2010). Furthermore, throughout USA by average, hospitals use two to four OGP contracts per institution. This fact affirms their importance and growing interest for OGP. Estimates demonstrate that OGP services provide saving in hospitals, nursing homes etc. between 10 and 15% of procurement costs. More than 600 organizations in USA have participated in some form of group procurement. Some of the typical OGP characteristics are (Benton, 2010):

- OGPs create contracts with sellers (for example producers) on the behalf of their clients (for example hospitals);
- Sellers pay administrative fees to OGPs based on sales volumes. The fees are used to finance operation. Resource surpluses are distributed to owners or are used to finance new business endeavours;
- OGPs can be distinguished by size, service scope and property type;
- OGPs do not possess supplies nor do they participate in any other supply chain aspect.

The cash flow connected to hospital procurement using OGPs is shown on figure 2.

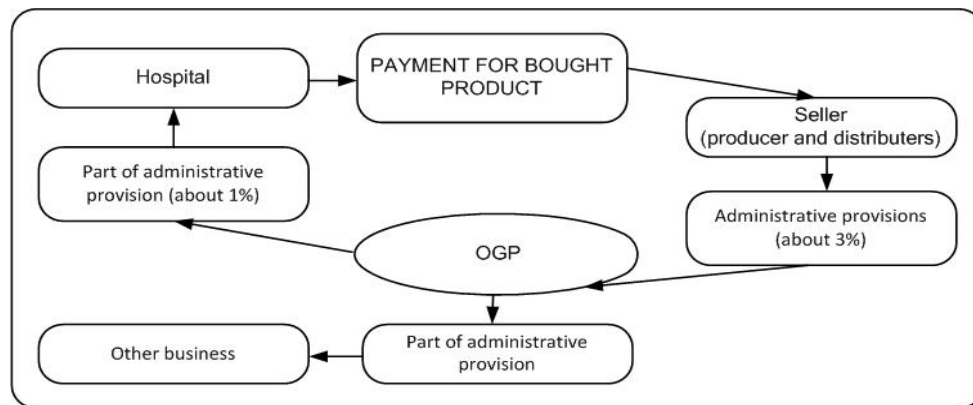

**Figure 2. The cash flow connected to hospital procurement using OGP (Benton, 2010)**

### **The procedure of capital medical equipment procurement**

Capital equipment procurement, such as complex medical instruments, semi-robots and robots, machines for surgical assistance etc., presume that healthcare institutions form precise internally defined processes. Differentiating corporate policies and preferred methods of payment shall certainly influence this process. Western experiences show that procurement procedure of these goods is initiated by setting an order for capital equipment procurement. Departments initiating the procurement process are obliged to deliver adequate statistics of usage or potential usage of that equipment, with high prediction (preciseness) level of that statistics. The orders are then revised by one or more entities in charge of procurement: the committee for public procurement, the supply chain management department, as well as the finance department. Approved order is then matched with available budget. If this phase is also passed successfully, demand is suggested for budgeting. It is necessary to mention, that eventhough certain equipment might surpass the available budget, but its procurement is undoubtable, specially formed contingency funds are used. They can participate up to 10 to 25% of totally needed funds.

The main factors influencing decision making about a capital asset, or when choosing between two options, refer to (Watts et al., 1993):

- **Society interest.** This is the starting criterium that needs to be taken into account when making a decision;
- **Marketability.** This represent a concept influencing both internal and external stakeholders in the healthcare sector. Besides considering what the community needs, the hospital should determine the level of marketability of a certain equipment from the perspective of the user;
- **Healthcare institution business goals.** This criterium should determine weather the object of capital procurement is the replacement of an existing unit (financed from amortization funds), the expansion of present technology or expansion into new business area. Seen from the business perspective, new technology is often less urgent to buy and its acquisition is harder to justify, then replacing existent, known technology.
- **Competitiveness.** Assumes sublimation of previous criteria, since regardless of specifics, healthcare institutions basically represent business units. This criterium is therefore very important for consideration.



Besides defining the most important factors during procurement process it is necessary to determine the best supplier for a certain healthcare institution. Respecting that aim the following should be determined (Watts et. al,1993):

- **Determination of functional specification.** Before determining the list of qualified suppliers, the healthcare institution needs to articulate its needs. It is important that every single article can be acquired from at least two suppliers, and that fair treatment of every supplier is guaranteed.
- **Defining the system of preference point giving.** Useful tool, very adequate when it comes to procurement in radiology and nuclear medicine equipment. After determining the important features of acquiring unit, every supplier is graded for every one of them, on the scale from 1(worst) to 10(best). A competing list is made from suppliers with the best score.
- **Candidate evaluation from the competing list.** Having used the preference system, best supplier have been identified. They are gathered at a rehearsal competing union, where competing rules are presented to them. Soon after, a real competing is organized, and the best offer is chosen.

#### **Key problems of Serbian healthcare management with focus on procurement process**

Analyzing the issues in Serbian healthcare, even the most competent and systematic researcher would be troubled. Inadequate business settings, where the perception of healthcare by professional, but also wider audience, highly correlates it with system of stressed entropy and activities of corruption, speaks for itself. Attempting to obtain relevant data which determine the greatest issues in this sector and which leave consequences on quality of all business segments, among which procurement, we define at least two problem levels. Within research domain we define them as:

- Problems of Serbian macro healthcare management;
- Problems of organization and management of micro healthcare subjects;

An important methodological note is that there is no clear line of distinction between two identified levels. Although it may seem that such a classification opens a wider issue scope than the very topic, we consider that precisely this kind of issue setting is necessary, so that we can deduct the very problem essence. Namely, the degree of cause and effect correlation is more than expressed, since the anomalies of macro management determine the appearance of an entire set of irregularities and microlevel operative problems. Thus, the microlevel situation is a direct consequence of macrolevel arrangement. Analyzing the microlevel our focus is mostly on procurement. Problems identified in the paper have been obtained as a combination of detailed search of secondary available data, but also via case-study method and interviews with a greater number of referent experts from different levels of the healthcare sector. The following table summarizes the main identified problems:

**Table 1. Key identified problems in healthcare and procurement management**

Healthcare Macromanagement	Micromanagement (with focus on procurement)
Inadequate education structure and workforce profiling	Constant lack of doctors of certain profile, unemployment of those doctor with surplus profile. Lack of managerial staff in healthcare management, especially in procurement
Lack of clear institution financing system by merit and achieved activities	Attempts in manipulation while competing for funds. Excessive spending and gathering unneeded procured supplies
Desorganization and feeble efficiency concerning patient curing promptness	Creating artificial waiting lists, which opens up possibilities for corruption of wider limits
Avoiding the determinants of Public procurement law	Manipulation of the procurement process of drugs and healthcare institution equipment. Fake and dubious tenders
High level of corruption, numerous affairs and healthcare scandals	Low credibility in doctors and entire healthcare sector

As seen within preliminary review, the list of issues is certainly not short and we do not consider it final (just opened for some future research). Continuing, in short we shall define the essence of each identified problem.

One of key unsolved healthcare management issues is **the establishment of clear and planned policy of human resource management in this sector**. Unfortunately, neither national education institutions nor responsible ministries put sufficient efforts to profile the workforce, so that after graduation, there would be work for everybody. The specialization for some profiles that are in evident surplus is approved despite that fact, while same areas in medicine-pathology, anesthesiology etc. are in constant lack of experts. Their lack or rareness, opens up the possibilities for existing personnel to be additionally prone to corruption (due to less competition and less options for patients to turn to). Special aspect of this problem on healthcare microlevel concerns not only adequate structure of medicine experts, but also other branches which should by all rights participate in running healthcare institutions. Western solutions show that the head management, but also management of certain logistic functions, such as procurement, should be team organized (a doctor and an economist). Such teams, with people of managerial profile, are necessary when it comes to planning resource volumes, prices, terms of supply and stocks policy. Since that is not the case in Serbia, besides other sector issues, a special shortcoming is vital managerial knowledge which can lead to drastic savings, efficient business and generally better organization.

The second problem refers to **lack of clear system of healthcare institution financing**. As we have had the opportunity to stress, some developed, western markets, such as USA, have established a DRG system based on compensation for achieved performances. Although it may not be the best way to determine funds for healthcare institutions, it is certainly more adequate than the unarranged situation in our country. Namely, according to certain research conducted concerning this topic, but also according to statements of the minister in charge of this area, it is not rare that institutions try to make certain manipulations while competing for funds and procurement of equipment. During 2011,

while acquiring software, general equipment but also financial funds for healthcare institutions, more than 11 institutions have been identified in an attempt to commit some kind of fraud (Blic newspaper online, 10 April 2012). Certainly that the number of these irregularities is far greater, however, due to inadequate control, it is hard to determine the exact state. That is why suboptimal procurement management is present in healthcare institutions. Due to mentioned problems, but also general mismanagement in supply chain of medical equipment in Serbia, often certain medicine/equipment is wasted as surplus on stock, while others are in constant lack. However, since the purpose of this equipment is not only normal functioning of healthcare institutions, but primary to save human lives and to give it better quality, shortcomings within this field can and sadly do, leave fatal consequences.

Special problem aspect in Serbian healthcare is connected to *general term of inefficiency*. Namely, an inevitable situation even when going to routine check-ups are long waiting lines and a lot of time spent. With the complexity of healthcare service growing, so does the time needed for that service to be accomplished. Therefore, it is not a rare situation to wait for an operation a few months, even years! Bearing in mind the urgency of some procedures, during waiting time patients' health usually gets worse, and seldom has permanent consequences. The alternative, opted by those who can afford it, is the private healthcare sector. However, according to last available data from RIS, average salary in Serbia is around 360 Euros (RIS, 10 April 2012), while prices for a basic check up in private sector vary from 20 to 50 Euros, and for some services even go up to 100. It is therefore clear that this option is a privilege of few. So, a special kind of paradox arises in Serbian healthcare- on one hand, we have «free of charge» public healthcare, which is too slow and inefficient, and on the other we have the private one, which is financially prohibitive for many. Which ever side is analyzed, patients are the party facing serious trouble! Transferring the problem to microlevel management, artificial waiting lists are created, which are easily modified, with certain financial incentive. More serious problems are located in procurement. There are situations of procurement and usage of over-dose medicaments, so that the doctors in charge would make the best deal possible with pharmaceutical houses, for high fees in return. Numerous affairs, some with tragic outcome, serve as best witness that what we are stating are not exaggerations and rumours (Kurir newspaper online, 8 April 2012).

So, another key issue of Serbian healthcare sector are *abuses in public procurement*, even when the corresponding law in this area is not formally broken. However, data from local institutions dealing with these issues claim that only a small portions of cases concerning healthcare procurement have ever been investigated. This is due to cunning fraud organization, where during tender application in healthcare, such specifications are made, that only the firm for which the business was entitled, can get the job. In that manner, the formal procedure is carried out, law has not been broken, but the manipulation has been effected. The consequences of these actions include: higher prices of equipment/medicine then regularly, bad procurement conditions, equipment//medicine of suspicious quality etc.

Connected with previous, is the issue of *general problems of corruption* in Serbian healthcare. To be objective, these problems are not only present in Serbian milieu, but are subject of fight in regional countries, EU-candidates, but also member states. According to the report of Transparency International, leading agency in fighting corruption, it is necessary to implement a whole set of measures, described by this organization, to lower healthcare corruption to a minimum (Transparency International, 7 April 2012). Although we have not been able to find out the exact amount of financial funds spent on procurement in Serbian healthcare, mostly due to non-existing free secondary data, the secrecy connected to these information and lack of will by the respective authorities to pass on their information during our research, we did manage to get some, indirect information about this topic from the World Bank data base. According to estimates of World Bank, Serbia has the highest spending level on healthcare in Europe (when it comes to what patients actually, both open and hidden pay), and a total corruption and fraud damage in this area is estimated at about 500 million Euros annually. The same study indicates that corruption is highest among surgeons, gynecologists, and

thirdly anesthesiologists. Among surgeons, the most corrupted category are cardiac-surgeons, and neuro-surgeons, while among gynecologists the most corrupted are obstetricians. Corruption is least present in health centers and most in institutes and hospital centers (World Bank, 5 April 2012).

Summarizing the previously stated, we can see that the healthcare sector and its organization are in deep trouble, marked by numerous affairs and scandals (the pig flu affair, the cytostatic affair etc, are only examples of some). This leaves a bad general image of the healthcare sector, its general management, but also management of certain areas, as we have seen on the example of procurement.

### **Instead of a conclusion- set of expert measures for surpassing/minimizing identified issues**

Generally, when analyzing the differences in management and organization between Western and Serbian healthcare we need to be quite realistic- many solutions can not just be copied, no matter how much we would want them to. State investment in Serbian healthcare are not even approximate or comparable to any high-developed country. Furthermore, the inherited problems of the healthcare system, analyzed in the paper, have now exploded, and time is needed to set them to a better acceptable state. In order to solve these problems, serious turns and business changes are needed, both in domain of healthcare management, but also in specific functions, such as procurement.

However, there are activities, first of all in general management, and specially in procurement management, which can be fixed in a short time period. Mostly, these issues could be surpassed or at least minimized with adequate human resource policy in healthcare. Changes should be carried out on both analyzed levels, with the initiative coming from the macromanagement, while detailed operationalization and problem solving should logically be transferred to the level of individual healthcare unit. Bearing in mind global solutions, but also locally identified shortcomings, we have selected only certain measures which should be seriously considered within state healthcare system in the future. It is clear that the entire healthcare sector is vast, so we do not consider to have covered with these measures all problems. A more thorough analysis is yet to come, as part of our future investigation. So, the identified measures include:

- Increase of total efficiency and rationality in healthcare institution business, firstly by redesigning the system of compensation and fund application. Usage of certain global solutions, such as analyzed concept DRG, with respect of national characteristics and economy strength;
- Creating and leading responsible management policy of all resources, specially, human. Optimizing the number and structure of healthcare workers, according to market needs, and not any other criteria;
- Introducing mixed management, for medical and non-medical tasks in every healthcare institution. The necessity of hiring managerial profiles for leading positions, where these skills are needed (general institution management, procurement, logistic and financial healthcare functions etc.);
- Introducing modern software and concepts, by which the problem of inefficiency could be surpassed, with respect to speed of providing healthcare service and elimination of artificial waiting lists;
- Strict control and obedience of Public procurement law. Higher cooperation between juridical and executive government, in order to justly punish frauds, and which is more important, to effectuate the punishment.

These are just some of the measures needed to revitalize the healthcare sector but also some of its business functions in period to come. Only determined and consistent implementation of measures can repair the "clinical image" of the entire sector and its functions. On the contrary, consequences will certainly be long lasting, unthinkable and surely with fatal outcome for all key entities.

The aim of this paper was to identify the key characteristics and shortcomings of the procurement management process in Serbian healthcare. We consider it to be a pioneer paper in this area. As such it opens many questions and dilemmas for further research. First of all, in this paper we have made an insight into the general process of healthcare procurement and its main issues. Therefore, the paper does not have the specific focus on one particular aspect of procurement, for instance, procurement of smaller equipment like surgical instruments, laboratory supplies and/or a range of disposable and reusable medical products. This is an excellent potential topic of analysis of our future work, which can be analyzed in detail using, for example, in-depth case study method. Another aspect of our research to come can focus on specific issues, characteristic for healthcare procurement process of a certain number of selected regional countries and their comparison. This can be achieved in form of primary, field research, using the survey method combined with secondary data analysis. These are just some of the ideas for future research activities, opened by the analysis of such a complex topic, as the healthcare procurement management.

## **References**

- Acharyulu, G. V. R. K., (2007), RFID in the Healthcare Supply Chain: Improving Performance Through Greater Visibility, *ICFAI Journal of Management Research*, p32-45., Vol. 6, no.11.
- Aćimović, S., Mijušković, V., (2012), Efficient procurement management as a source of competitive advantage in turbulent market conditions, In: *Economic development and institutional organization, Volume I*, (Backović, M. and Karadžić, V., eds.), Belgrade: CIDEF, pp.227-243.
- Benton, W., (2010), *Purchasing and supply chain management* (2<sup>nd</sup> ed.), Avenue of the Americas, New York, NY, 10020: McGraw Hill International.
- Božić, V., Aćimović, S., (2012), *Marketing Logistics* (5<sup>th</sup> ed.), Belgrade: CIDEF.
- Chester, M., Zilz, D., (1989), Effects of bar coding on pharmacy stock replenishment, *Journal of Hospital Pharmacy*, pp. 1380-1385 Vol. 46, Issue 7.
- Davis, C., Rhodes, D., (1988), The impact of DRGs on the cost and quality of health care in the United States, *Health policy*, pp. 117-131, Vol. 9, Issue 2.
- Lovreta, S., Petković, G., (2010), *Trade management* (6<sup>th</sup> ed.) ,Belgrade: CIDEF.
- Lysons, K., Gillingham, M., (2006), *Purchasing and Supply Chain Management, 7th Edition*, Edinburgh: Pearson Education Limited.
- Mijušković, V., (2011), Alternative procedures and important aspects of procurement management, *Montenegrin Journal of Economics*, pp. 133-142, Vol.7, no.1.
- Porter, M., (1985), *Competitive advantage*, New York: Free Press.
- Raviprakash, V., Prabu, B., Alagumurthi, N., Soundararajan, V., (2009), RFID: Rx to Healthcare Industry, *ICFAI Journal of Supply Chain Management*, pp. 7-25, Vol. 6 no. 2.
- Schreyogg, J., Stargardt, T., Tiemann, O., Reinhard, B., (2006), Methods to determine reimbursement rates for diagnosis related groups (DRG): A comparison of nine European countries, *Healthcare management science*, pp. 215-223, Vol. 9, no.3.
- Smith, A., Flanegin, F., (2004), E Procurement and Automatic Identification: Enhancing Supply Chain Management In the Healthcare Industry, *International Journal of Electronic Healthcare*, pp.176-198, Vol. 1 no. 2.
- Watts, D., Finney, L., Louie B., (1993), Integrating technology assessment into the capital budgeting process, *Healthcare financial management*, pp. 21-29. Vol.6, no.1.

**Online sources**

Blic newspaper online (10 April 2012), <<http://www.blic.rs/>> .

Kurir newspaper online (8 April 2012) ,< <http://www.kurir-info.rs/>> .

Republic Institute for statistics (10 April 2012), <<http://webrzs.stat.gov.rs/>> .

Transparency international (7 April 2012), <<http://www.transparency.org/>> .

World Bank (5 April 2012) ,<<http://www.worldbank.org/>>.

# STRATEGIC COST MANAGEMENT AS A REPLY TO CHALLENGES OF MODERN BUSINESS ENVIRONMENT

Violeta Domanović<sup>1</sup>

Vesna Stojanović-Aleksić<sup>2</sup>

**Abstract:** *Cost management is a critical success factor of companies in contemporary business environment, which requires a proactive orientation, flexibility and responsiveness to changing demands in the environment. The key idea of the paper is that a success of a company is the result of developing and implementing effective strategies supported by the methods and tools of management accounting and strategic management. Unlike traditional cost control systems that are routinely applied on continuous basis, cost management is applied on ad hoc basis when the possibility of cost reduction is identified. Strategic cost management is the application of cost management techniques so that they simultaneously improve the strategic position of a company and reduce costs. The increasing pressure of global competition, technological innovation and changes in business processes have made that cost management is much more critical and more dynamic than ever before. The paper is going to stress the necessity of strategic cost management in contemporary business environment and to introduce and analyse some tools in order to reduce costs and increase profitability.*

**Keywords:** *contemporary business environment, strategic cost management, strategic management and management accounting tools.*

## Introduction

The business arena in which companies operate today is significantly different than in the past. Questions that come to mind to contemporary commercial entities are related to the driving force of the business environment in the 21st century, the implications of the modern business environment, as well as the steps they should take in order to survive, grow and develop in the long-term in such an environment.

Present time is characterized by discontinuity, uncertainty and turbulence. Some regard it as a period of shock or future digital revolution. The others use terms like post-industrial society, third wave, the knowledge society, the information age and the digital revolution. What is common to all these conceptions is that the dynamism of environmental factors affirms the importance of proactive relationship of the enterprise with the environment, businesses and as well as the importance of preparing for future business conditions. In the modern business environment, a successful company differs from the failure by the ability to manage change, not by the status of the status quo (and Djuricin Janošević, 2005).

The key changes in the modern business environment are related to the different role of knowledge, processes of globalization, the basic transformation, expanding the range of technological possibilities, production of fundamentally new technologies (information technology, biotechnology, new materials) and to the change of the management and organization concepts (Djuricin and Janošević, 2005). This seems to introduce new cost measurement and management and corporate performance management methodologies, as always "exhaustible" source of the competitive advantage.

---

<sup>1</sup> Faculty of Economics, University of Kragujevac, vterzic@kg.ac.rs

<sup>2</sup> Faculty of Economics, University of Kragujevac

## **STRATEGIC COST MANAGEMENT AS A REPLY TO CHALLENGES OF MODERN BUSINESS ENVIRONMENT**

---

For Shank & Govindarajan (1993), cost management can lead to an effective cost control and can ensure an advantage against the competition. From the 80s in the 20<sup>th</sup> century, new cost management practices emerged in response to criticism about the usefulness of the traditional managerial accounting techniques, which generally were based on the internal factors. The necessity of the contemporary business environment has imposed the need for considering also the environmental factors external to firms, which created a new knowledge field and professional practice called *Strategic Cost Management – SCM*.

The adoption of strategic cost management practices by the companies has been the subject of several studies (Guilding, Cravens and Tayler, 2000; Bowhill and Lee, 2002; Dekker and Smidt, 2003, Waweru, Hoque and Uliana, 2005; Cinquini and Tenucci, 2006; Cadez and Guilding, 2007; Noordin, Zainuddin and Tayler, 2009; Angelakis, and Thérío Floropoulos, 2010). The studies showed that this concept has more been adopted in developed countries like Japan, Italy and United States of North America.

The paper is going to stress the necessity of strategic cost management in contemporary business environment and to introduce and analyse some tools in order to reduce costs and increase profitability. Thus, in the following sections, there will be words firstly about the mere characteristics of the contemporary business environment; then, generally about the new concepts of the strategic enterprise management; then, about the necessity of introducing the strategic cost management in the contemporary business environment, as the basis for the strategic positioning and competitive advantage.

### **Characteristics of the contemporary business environment**

Technological development is achieved through the application of new technologies in products, processes and services in all sectors of the economy. There has been the broader domain of influence of technological change on society as a whole, so that we might talk about the process of institutionalization of technological innovation. We are the witnesses of the impact of technological change on the creation of new economic, political and social relations. The third industrial revolution is a phenomenon whose consequences are global and which, moreover, brings continuous period of uncertainty (Domanović, 2010).

According to Prahalad's view (Prahalad, 1998), the competitive environment in the future will shape the next eight major discontinuities: globalization, which calls for creating competitive advantage on a global scale, deregulation and privatization, the volatility of almost all industries, the convergence of various technologies, ambiguity of the industrial borders, operations based on standards, reducing the number of intermediaries and environmental sensitivity.

Integrated understanding of the external and internal environment provides companies with information that is of particular importance when observing the present and anticipating the future. External environment of the company can be divided into three main areas: general, industrial environment and competitors' environment (Hitt, Ireland and Hoskisson, 2001). In combination, the results of the environmental influence analysis affect the development of strategic intentions, strategic mission and strategic actions. Analysis of the general environment is focused on the future, industry environment analysis on understanding of the factors and conditions that affect the profitability of the company, while the competitors' analysis is focused on predicting the dynamics of actions, responses and intentions of competitors (Hitt, Ireland and Hoskisson, 2001, Lynch, 2000; Djuricin and Janošević, 2005).

The above changes in the business environment in recent years have caused significant modifications in the practice of cost management.



### **New concepts of the Strategic Enterprise Management (SEM)**

Modern business environment imposes the need for finding and defining new concepts and tools to support the strategic enterprise management. The aim of introducing new concepts is certainly raising the overall efficiency of the company. Some of these concepts that deserve the attention of modern managers are: total quality management (TQM), kaizen costing, activity-based costing, reengineering, life-cycle costing, value chain and balanced scorecard (Blocher et al., 2005).

#### ***Total quality management***

Total quality management (TQM) is a technique that helps managers to develop policies and practices to ensure that products and services exceed customer expectations. This approach includes expanded functionality, reliability, consistency and courtesy. Cost management is carried out in order to analyze the effects of different design choices for total quality management, and to measure and report on the many aspects of quality including, for example, bottlenecks in the production process and defects, unproductive labour or materials expended, the number of service calls and nature of complaints, warranty costs and product recall.

TQM efforts can build brand loyalty and assist the company to rapidly improve product quality and competitiveness. For example, Hewlett-Packard has introduced a policy of returning the product that customers returned to retailers - something that many computer manufacturers did reluctantly. This policy builds customer loyalty and offers retailers and Hewlett-Packard the early warning of problems products.

#### ***Kaizen costing***

Continual improvement (*Kaizen* is a Japanese word) is a management technique by which the managers and employees are devoted to programs of continual improvements in the quality and other critical success factors. Its origin is attributed to the Japanese manufacturers who tirelessly search for quality. Continual improvement is often associated with the practice of comparing with rivals in the industry (benchmarking) and total quality management as companies seek to identify other companies as models to learn how to improve their critical success factors.

#### ***Activity-based costing (ABC)***

Many companies have realized that they can improve planning, product costing, operational control and management control using analysis of activities in order to develop a detailed description of the specific activities that are performed in the business. The analysis provides the basis for the activity based costing and activity based management (*Activity-Based Management - ABM*). Activity-based costing is used to improve the accuracy of the analysis of costs by improving the allocation of costs to individual products or customers. Activity based management implements the activity analysis as a way of operational and management control. *ABC* and *ABM* are the key strategic tools for many companies, especially those with complex business or a large variety of products.

#### ***Reengineering***

Reengineering is the process of creating a competitive advantage when the company reorganized its operational and management functions, often with the result that jobs are modified,

## **STRATEGIC COST MANAGEMENT AS A REPLY TO CHALLENGES OF MODERN BUSINESS ENVIRONMENT**

---

combined or eliminated. It was defined as "a fundamental rethinking and radical redesign of business processes in aim of dramatic improvements in critical, contemporary performance measures, such as cost, quality, service and speed" (Hammer and Champy, 1993). Under the pressure of global competition, many companies look to re-engineering as a way to reduce the cost of management and operations, and as a basis of a careful re-analysis of strategic competitive advantage. Cost management supports reengineering efforts by providing relevant information.

### ***Life-Cycle Costing***

*Life-cycle costing* is a management technique that is helpful in the process of identifying and controlling the costs of the product throughout its life cycle. The life cycle includes all the steps starting from product design and procurement of raw materials to delivery of finished products and service. These steps include: (1) research and development (2) product design, including prototyping, testing, and cost targets, (3) production, inspection, packaging and storage, (4) marketing, promotion and distribution, and (5) sales and services. Cost management has traditionally been focused only on costs incurred in the third step, i.e. production. Thinking strategically, management accountants now manage the life-cycle costs, including the costs in the upstream and downstream part of the value chain and production costs as well. This expanded focus means that management accountants pay special attention to product design, given that the costs of design reflect the costs of the future phases of the product life cycle.

### ***Value Chain***

The value chain identifies specific steps to ensure the creation of a competitive product or service to customers. In particular, the analysis of value chain management helps companies to disclose what steps or activities are not competitive, where costs can be reduced or whose activity should be outsourced. In addition, the company may apply the analysis of the activities to find ways to increase the value to the customer in one or more steps of the value chain. For example, companies such as Dell, General Electric, IBM and Honeywell have made greater overall profits by moving down in the value chain. The key idea of the value chain analysis is that the company should carefully study each step of the business to determine how each activity contributes to the profit and competitiveness (Wise and Baumgartner, 1999).

### ***Balanced Scorecard – BSC***

Strategic information, which takes into account the critical success factors of companies, provides management a detailed report that allows a supervision of the competitive process and serves as a benchmark for comparing the success with its competitors. Financial measures such as profitability reflect only partial and often only short-term measures of progress the company. Without strategic information, the company is likely to deviate from its course and make up strategically wrong decisions about the products, for example, chooses the wrong products, marketing and distribution methods.

In order to highlight the importance of the strategic use of information, financial and non-financial, the accounting reports on the performance of the company are now often based on the critical success factors of companies grouped into four different perspectives. One dimension is the financial and the other three are non-financial ones (Kaplan and Norton, 1996):

- *Finance*: Ratios of profitability and market value, such as indicators of how successful the company satisfies its owners and shareholders.
- *Customer satisfaction*. Measure of quality, service, lower costs, as indicators of how successful the company satisfies customers.
- *Internal business processes*. Measures of efficiency and effectiveness in the production of goods and services.
- *Innovation and learning*. Measures of the company to develop and utilize human resources to fulfil its strategic objectives in the present and the future.

The accounting report containing these four dimensions is called the *balanced scorecard*. The concept of balance includes the intent of extensive coverage, financial or non-financial, of all the factors that contribute to the success of companies in achieving strategic goals. The Balanced Scorecard provides the basis for a more complete analysis of efficiency than is possible only on the basis of financial data. Consistent application of the balanced scorecard is therefore a critical component of a comprehensive approach that takes the company to become and remain competitive.

### **The necessity of strategic cost management in contemporary business environment**

Current economic circumstances exert a significant pressure on corporations that, in order to improve efficiency, better manage costs. The success of a company is the result of developing and implementing effective strategies supported by methods and tools of management accounting. Cost management is a broad concept and focuses on reducing costs and continually improvement and change rather than on the cost content itself. Unlike the traditional systems of costs control that are routinely applied on continuous basis, cost management is applied on an *ad hoc* basis and when it is necessary to identify the opportunities to reduce costs. Many approaches that have been incorporated into the area of cost management do not always involve the application of accounting techniques. In contrast, cost control relies heavily on accounting techniques.

Cost management consists of those actions that managers take to reduce costs, some of which are based primarily on information obtained from the accounting system. Other actions, however, are undertaken without the use of accounting information. They include improvements to the process, which identifies the ability to perform processes effectively and efficiently, which will have obvious effects on reducing costs.

In today's business environment, cost management has become a critical success factor for the company. Today, simply reducing costs is not enough; instead, the costs must be strategically managed. Strategic cost management is the application of cost management techniques so that they simultaneously improve the strategic position of a company and reduce costs. Robin Cooper and Regine Slagmulder suggest that it is necessary to make three distinct steps to convert from unfocused cost management to strategic cost management (Cooper and Slagmulder, 2003). *The first step* is to revise the existing and planned cost management initiatives to ensure that they enhance the strategic position of the company. *The second step* is to expand the scope of internal cost management beyond the walls of the factory (supply chain). *Finally*, these authors suggest that it is also necessary to expand the program of cost management outside the company to the whole supply chain (Schulze et al, 2012). There are three types of initiatives in relation to the cost management: those that strengthen, that do not affect and those that weaken the company's competitive position in the market.

The objective of strategic cost management is to reduce costs while increasing strategic position of the company. Based on this objective, strategic cost management cannot, as a traditional management accounting, be confined to the four walls of the factory. The dominance of financial

## STRATEGIC COST MANAGEMENT AS A REPLY TO CHALLENGES OF MODERN BUSINESS ENVIRONMENT

---

managerial accounting in the 20th century led to the atrophy of cost management practices. Traditional cost accounting systems are limited to the charges on the products as their proponents. Another potential cost objects, such as suppliers and customers are ignored and the costs related to them are treated as overhead costs that are allocated arbitrarily on products or are recognized as period expenses and directly entered in the income statement. This seems that it is not possible to manage the non-production costs because the main reasons of their occurrence are hidden. In order to manage these costs strategically, it is necessary to link them with some cost objects other than products. One of the primary techniques for this is *activity based management*. The advantage of this technique over traditional costing methods lies in the possibility that the costs, in accordance with the principle of causality, are calculated on the wide range of objects including products, suppliers and customers (Kaplan and Cooper, 1997).

The next step in the adoption of strategic cost management is the process to extend beyond the boundaries of the company, so called inter-organizational cost management (Fayard et al., 2012). Inter-organizational cost management (IOCM) is a strategic cost management practice that extends the application of cost management activities beyond the traditional management of internal costs to include managing costs among supply chain partners. In many cases, these activities are easily recognized as inter-organizational applications of traditional cost management activities, such as an inter-organizational application of activity-based costing (Kaplan & Narayanan, 2001). IOCM activities may also be viewed as supply chain management techniques benefiting supply chain partners, such as just-in-time processes to manage and control inventory levels (Berry, Ahmed, Cullen, & Dunlop, 1997; Callioni, de Montgros, Slagmulder, VanWasenhove, & Wright, 2005). The common theme defining IOCM activities is that they involve collaborative or cooperative actions among supply chain members to reduce costs and to create value for organizations in a supply chain (Coad & Cullen, 2006; Cooper & Slagmulder, 1998). Based on this view of inter-organizational cost management, the set of techniques for managing boundary spanning costs can be considered an organizational resource used to create firm value (Coad & Cullen, 2006; Cooper & Slagmulder, 2004).

In order to reduce costs along the value chain and the simultaneous strengthening the strategic position of the company, it is necessary to align the programs of cost management programs with suppliers and customers. The aim of this inter-firm adjustment of cost management programs is to find the better solutions for the greater cost savings, than in the case that the company, its customers and suppliers do it independently (Cooper and Slagmulder, 1999). Thus, strategic cost management requires that the company introduces changes that are similar to the changes in behaviour that is required from suppliers and customers. All these changes have both costs and benefits. The challenge of strategic cost management is to identify the economies of these changes, and then to find ways how each firm gains the benefit as the entire value chain becomes more efficient.

The *value chain* can also be more efficient if a certain company, its suppliers and customers together find ways to reduce production costs. In this case, it is possible to identify two techniques of cost management: *target costing* and *kaizen costing*. *Target costing* is applied in order to reduce costs in the design phase of the product, while the *kaizen costing* is used in the production phase. When any of these techniques identify the problem of costs, then the individuals from companies in the value chain can work together to resolve the problem.

Information about cost management is relevant to managers in order to improve corporate governance and includes as well as financial information about the costs and revenues so the relevant non-financial information on productivity, quality, and other key factors of a successful company.

Financial information, viewed in isolation, may lead to adverse business decisions, as they focus on the short term. In order to competitive success, the company needs to focus on long-term factors, such as the improvement of products and production processes, product quality and customer loyalty. An emphasis only on financial information may lead managers to focus only on reducing the costs (financial measure) neglecting or even undermining quality standards (non-gauge). Such a decision

may be a critical error that would lead to a loss of customers and market share in the long run. Internationally recognized business consultants, such as Edwards Deming, Peter Drucker and others emphasize the importance of considering non-financial measures and long-term operating results if the company tries to compete successfully in the market. Thus, information about cost management includes information - financial and non-financial and short-term and long-term – that manager requires so he could achieve the competitive success and what exactly *balanced scorecard* enables.

Contrary to the function of cost management, financial reporting function includes preparation of financial statements for external users, such as investors and government regulators. These statements of financial accounting require compliance with certain external requirements. Information about cost management is being developed for use in the company to facilitate the management, but it is not necessary to meet these requirements. The main attributes of cost management information must therefore be usefulness and timeliness, accuracy of financial statements and adjustment to reporting requirements. However, strict adherence to the accuracy might endanger usefulness and updating of information.

Effective strategic management is critical for the success of the company or organization. The increasing pressure of global competition, technological changes and innovations in business processes made that cost management is much more critical and more dynamic than ever before. Managers must think competitively and this requires a strategy.

Strategic thinking involves anticipating changes, and products and manufacturing processes are designed so to fulfil the demand changes. There is important a proactive orientation, flexibility and speed of response to the changing requirements of an environment. It is expected that the product life cycle - the time of the introduction of a new product to its removal from the market - will become shorter and shorter. The success achieved in the past is no longer a measure of success in the future; manager must manage the company looking at the 'windshield', not at the 'rear-view mirror'.

Putting an emphasis on the strategy also requires a creative and integrative thinking, i.e. an ability to identify and resolve problems at the cross-functional standpoint. Business functions are often identified as marketing, production, finance and accounting/control. Rather than being seen as a problem of production, marketing, finance or accounting, cross functional teams consider a problem from an integrative perspective that simultaneously combines the skills of all functions. Attention is focused on meeting the needs of customers; all the resources of the company, from all functions are directed towards this goal.

Since the strategic issues have become increasingly important in the field of management, cost management has evolved from the traditional role of the costing and operational control to a broader, strategic focus: strategic cost management (see Table 1).

Strategic cost management involves the development of information on cost management which facilitates major function of management - *strategic management*. The concept of strategic cost management results in the following main topics, taken from the literature on strategic management (Shank and Govindarajan, 1993): value chain analysis, strategic positioning analysis and cost drivers analysis.

Competing companies include emerging and anticipated changes in the modern business environment into their business planning and practices. Competitive firm is focused on the customer, applies advanced production technology and anticipates the consequences of changes in regulatory requirements and tastes of its customers and recognizes the complex social, political and cultural environment. Cost management focuses not only on the measure, but also to identify those measures that are critical to the success of the company.

**STRATEGIC COST MANAGEMENT AS A REPLY TO CHALLENGES OF MODERN BUSINESS ENVIRONMENT**

---

**Table 1. Management accounting paradigm *versus* strategic cost management paradigm (Shank and Govindarajan, 1993)**

<i>Relevant issues</i>	<i>Management accounting paradigm</i>	<i>Strategic cost management paradigm</i>
Which is the most useful way to analyse costs?	Over products, customers and functions With strong internal focus Added value is the key concept	Over the different phases of the total chain value in which the given company is only one link With strong external focus Added value is treated as a too narrow concept
What is the aim of the cost analysis?	Defines three objectives, regardless of the strategic context: measuring performance, directing attention and problem-solving	Although these three goals are always present, the design of cost management system changes dramatically depending on the basic strategic positioning of the company: either by the strategy of cost leadership or product differentiation strategy
How the cost behaviour should be treated?	The cost is primarily a function of production volume: variable cost, fixed cost, individual cost, the combined cost	The cost is a function of strategic choices on how to apply and the skills of managers in the implementation of strategic choices in terms of the structural causes of the costs and causes of costs in the enforcement process

**Strategic positioning and competitive advantage**

Competitive advantage is the ability of companies to outperform their rivals in terms of one of the primary goals - profitability. However, the company may sacrifice profits for the sake of the ongoing investments in technology or market share, or profit may be waived in order to provide greater customer satisfaction, philanthropy, employee benefits, or benefits in employment.

Anita McGahan and Michael Porter on the basis of the research concluded that the state of the industry affects about 18% of the variation among the companies' profits and competitive position of about 32%. Other possible systematic effects on the profitability of the company, such as variations in profits due to changes in macroeconomic conditions, or change the owner of a business unit, is relatively small. Significant component, which affects nearly 43% of variation of profit, is unsystematic. This component represents the variation that cannot be explained by any systematic influence (McGahan and Porter, 1997).

Competitive advantage cannot be reduced simply to a formula or algorithm. The company, which has the cost advantage, creates greater value by offering products that have caused a lower cost, with the same, or even lower, the perceived benefits. This occurs in three qualitatively different ways. Firstly, the company can achieve parity by offering the same benefits as rivals, for example, exploiting economies of scale in order to reduce the average cost compared to its rivals, which produce the same product, but on a smaller scale. Secondly, the company can achieve nearly the same benefits, including an offer that is much lower than its competitors. Finally, the company can offer a product that is qualitatively different from its competitors. Competitive advantage can sometimes be constructed by redefining the product to take advantage of substantial differences in the benefits and costs compared to the traditional understanding of the product.

Looking for a cost advantage, the objective of the company is to become a leader in costs in its industry or industry segment. Leadership in the cost is a unique position in an industry that requires the company "must find and exploit all sources of cost advantage ... (and) ... selling standard, undecorated products" (Porter, 1985). "The differentiation is achieved "when a firm provides something unique, something that is valuable to customers and beyond simple supply and at a lower cost" (Porter, 1985).

These two sources of competitive advantage define two fundamentally different approaches to business strategy. The company, which competes on the basis of lower cost, varies from companies that compete through differentiation in terms of market positioning, resources and capabilities and organizational characteristics.

According to these types of competitive advantages with choose of scope and extent of the company - a broad market versus a narrow market segment - Michael Porter defined three generic strategies: cost leadership, differentiation strategy and focus strategies. Porter considered these two strategies as mutually exclusive. If a company has a try to gain the benefits of both strategies, it "lies somewhere in the middle".

It is more than likely that companies that find themselves in the middle are not very profitable. They lose big customers who demand low prices or have to forgive part of the profits to win business from low – cost companies. However, these companies also lose highly profitable business – - cream - from companies that are focused on high – profit targets or differentiate their products. Companies that fall into the middle probably suffer from blurred corporate culture and conflicting set of organizational agreements and motivation system (Porter, 1980).

Reconciliation of the product differentiation strategy with low cost was one of the greatest strategic challenges of the 90's in the 20th century. The success of Japanese companies in a wide range of products, from automotive and consumer electronics to musical instruments came because of their ability to connect low cost with quality unprecedented. Principles and methods of total quality management that these companies have adopted and developed dispelled the myth that there is a balance between high quality and low cost. A higher quality in terms of minor defects and higher product reliability frequently involves a simpler product design, smaller suppliers of components that can be closely monitored and fewer service calls and product recall - which affects the economy of all costs.

Differentiation and reduction in costs can be complementary in other ways. The high cost is advertising and promotion can increase its market share, which then provides exploitation of economies of scale across a wide range of products. The existence of economies of scale in advertising and others means that leader in market share can improve its relative cost position forcing rivals to compete on the basis of product differentiation.

### **Cost advantage**

Historically, in the analysis of business strategy, cost advantage was emphasized as the primary source of competitive advantage. Focus on cost advantage reflects the traditional emphasis on price as the primary means of competition among enterprises – competing based on price depends on cost efficiency. It also reflects some of the major strategic concerns of large industrial corporations. During the 20th century, the large corporations' strategies took into account the request for economies of scale and diversity through investments in mass production and mass distribution.

Since the mid 80's of the 20th – century, the economy is a priority, but the focus has shifted toward cost reduction through restructuring, by laying-off, hiring external services, introducing the

## STRATEGIC COST MANAGEMENT AS A REPLY TO CHALLENGES OF MODERN BUSINESS ENVIRONMENT

---

lean production. Also, there was highlighted the requirement for a dynamic rather than static sources of efficiency.

For some industries, the cost benefit is the predominant basis for competitive advantage. Even when the competition focuses on product differentiation, intensifying competition has resulted in cost-efficiency, as well as the assumptions of profitability.

Request for cost economies based on experience includes that the primary strategic goal of the company should be to increase market share. The increase in cumulative production of a company compared to its competitors depends on the relative share of each company. If the relative share of a company is twice greater than the relative share of each other, then the first company will sooner reduce costs at a rate twice greater than of its competitors.

The key for cost analysis is to go beyond the purely mechanical and empirical approaches such as the experience curve and to find the factors that determine the cost position of the company. Experience curve combines five sources of cost reduction: economies of scale, economies of learning, improved process technology, improved product design and redesign processes (Grant, 1998). Other factors that affect the relative cost position of the company might be added to this complex: capacity utilization, input costs and residual efficiency. Factors that determine the unit costs are the cost drivers (see Table 2).

**Table 2. Cost advantage drivers (Grant, 1998)**

<i>Cost advantage drivers</i>	<i>Cost drivers origin</i>
Economies of scale	<ul style="list-style-type: none"> <li>• Factors indivisibility</li> <li>• Specialization and division of labour</li> </ul>
Economies of learning	<ul style="list-style-type: none"> <li>• Increased skills</li> <li>• Better coordination/organization</li> </ul>
Processed technology	<ul style="list-style-type: none"> <li>• Mechanization and automation</li> <li>• Efficient material usage</li> <li>• Greater accuracy</li> </ul>
Product design	<ul style="list-style-type: none"> <li>• Design for automation</li> <li>• Design for material economy</li> </ul>
Input costs	<ul style="list-style-type: none"> <li>• Location advantage</li> <li>• Having low-costing inputs</li> <li>• Negotiation power</li> <li>• Cooperation with suppliers</li> </ul>
Capacity utilization	<ul style="list-style-type: none"> <li>• Fixed/variable costs ratio</li> <li>• Installing and capacity closing costs</li> </ul>
Residual efficiency	<ul style="list-style-type: none"> <li>• Organizational surplus: difference between total available resources and resources necessary for efficient and effective performances.</li> </ul>

Starting from the multiple cost drivers, cost management involves multiple initiatives at different organizational levels. Careful analysis of existing activities in relation to competitors may



open opportunities to reduce costs by reducing input costs, achieving economies of scale and better use of capacity. At the same time, the company must seek opportunities for innovation and redesign process in order to exploit new sources of dynamic efficiency.

### **Differentiation advantage**

The differentiation advantage is achieved if the company is capable that by differentiating their products and services realize the difference in price that exceeds the cost of differentiation.

Analysis of differentiation from the point of supply tells us what a company can do in order to be different from the competitors, but the critical question is whether such a differentiation creates value for customers. If the purpose of differentiation is to realize a profit, then in the focus of the analysis is the potential to increase customer satisfaction and reduce customer costs. Understanding consumers' preferences, ways of their choice, their motivations, the company can identify opportunities for profitable differentiation.

The differentiation advantage implies identifying new and unique opportunities and developing innovative approaches to exploit them. There are two elements to create profitable differentiation. On the supply side, the company must be aware of resources and capabilities through which it can create uniqueness and do it better than its competitors. On the demand side, the key is in understanding the customer, their needs and preferences.

Visible differentiation is related to the physical characteristics of the products or services that are relevant to the selection process and the preferences of customers. These characteristics are size, shape, colour, weight, design, material and technology. Visible differentiation also includes the features of the product or service in terms of reliability, consistency, taste, speed, durability and safety. Products and services that are complementary to the observed products are also important for the differentiation potential. This includes resale services, after-sales service, availability and speed of delivery, banking and the opportunity to upgrade products in the future. For consumer goods, these variables determine the usefulness of direct differentiation that consumers receive from the products. For manufactured goods, differentiating variables affect the ability of companies to benefit customers in their work - hence these variables are a valuable source of differentiation if these companies reduce costs and increase their capacity for product differentiation.

Opportunities for invisible differentiation arise because the value that customers perceive in the product or service does not depend solely on the visible aspects of deals. There are a few products in which buyers choose only the range of physical characteristics. Social, emotional, psychological and aesthetic considerations are present in the choice of most goods and services. The desire for status, exclusivity, individuality and safety are extremely powerful motivational force in the choice of most consumer goods. In the event that a product or service meets the complex needs of customers, differentiation choices include overall image of the company offers. Issues related to the differentiation of the image are particularly important for those products and services whose quality and characteristics are difficult to determine at the time of acquisition ("good" experiential).

Differentiating differs from clustering. Differentiating gives the answer to the question of how the company competes - in what ways the company can offer its customers the uniqueness. This uniqueness may be related to the consistency (McDonald's), reliability (Federal Express), status (American Express), quality (Marx & Spencer) and innovation (Sony). Segmentation, in terms of choice of market segments, relates to the place in which the company competes expressed by consumer groups, locations and types of products.

Although in strategy analysis, traditionally there has always been emphasized cost advantage as a primary basis for establishing a competitive advantage over rivals, in many respects, low costs are

## STRATEGIC COST MANAGEMENT AS A REPLY TO CHALLENGES OF MODERN BUSINESS ENVIRONMENT

---

far less secure basis for maintaining a competitive advantage in relation to differentiation. Differentiation is less affected by changes in the external environment and the harder it is to copy.

The essence of the advantages of differentiation is to increase the perceived value to customers than competitors offer. This requires the company to harmonize the requirements and preferences of customers with its own capacity to create unity.

The value chain provides a useful framework for analyzing the benefits of differentiation. By analyzing how value is created for customers and the systematic assessment of the scope of each activity in order to differentiate, value chain provides the connection of the differentiation source from the standpoint of demand and supply.

\* \* \*

Modern business environment imposes the need for finding and defining new concepts and tools to support the strategic enterprise management. The aim of introducing new concepts is certainly raising the overall efficiency of the company. Current economic circumstances exert a significant pressure on corporations that, in order to improve efficiency, better manage costs. The success of a company is the result of developing and implementing effective strategies supported by methods and tools of management accounting. Cost management is a broad concept and focuses on reducing costs and continually improvement and change rather than on the cost content itself. Unlike the traditional systems of costs control that are routinely applied on continuous basis, cost management is applied on an *ad hoc* basis and when it is necessary to identify the opportunities to reduce costs.

In today's business environment, cost management has become a critical success factor for the company. Today, simply reducing costs is not enough; instead, the costs must be strategically managed. Strategic cost management is the application of cost management techniques so that they simultaneously improve the strategic position of a company and reduce costs.

Competing companies include emerging and anticipated changes in the modern business environment into their business planning and practices. Competitive firm is focused on the customer, applies advanced production technology and anticipates the consequences of changes in regulatory requirements and tastes of its customers and recognizes the complex social, political and cultural environment. Cost management focuses not only on the measure, but also to identify those measures that are critical to the success of the company.

### References

- Adler, R. (2011). Performance Management and Organizational Strategy: How to Design systems that meet the Needs of Confrontation Strategy Firms. *The British Accounting Review*, 43, 251-263.
- Angelakis, G., Theriou, N., and J. Floropoulos (2010). Adoption and Benefits of Management Accounting Practices: Evidence from Greece and Finland. *Advances in Accounting*, v. 26, n. 1, 87-96.
- Apak, S., Erol, M., Elagoz, I. and M. Atmaca (2012). The Use of Contemporary Developments in Cost Accounting in Strategic Cost Management. *Procedia – Social and Behavioral Sciences*, 41, 528-534. Available online at [www.sciencedirect.com](http://www.sciencedirect.com)
- Berry, T., Ahmed, A., Cullen, J., and A. Dunlop, A. (1997). The Consequences of Inter-firm Supply Chains for Management Accounting. *Management Accounting: Magazine for Chartered Management Accountants*, 75, 74-75.
- Blocher, J. E., Chen, H. K., Cokins, G., and T. L. Win (2005). *Cost Management. Strategic Emphasis*. Third edition. McGraw-Hill/Irwin.

- Bowhill, B., and B. Lee (2002). The Incompatibility of Standard Costing Systems and Modern Manufacturing. *Journal of Applied Accounting Research*, v.6, n.3, 1-24.
- Cadez, S., and C. Guilding (2007). Benchmarking: the Incidence of Strategic Management Accounting in Slovenia. *Journal of Accounting & Organizational Change*, v.32, n.2, 126-146.
- Cellini, G., de Mottos, X., Slagmulder, R., VanWasenhove, L. N., and L. Wright (2005). Inventory-Driven Costs. *Harvard Business Review*, 83, 135.
- Cinquini, L., and A. Tenucci (2006). Strategic Management Accounting: Exploring Links with Strategy. Disponível em: <http://www.unisanet.unisa.edu.au/Resources/.../Cinquini%20&%20Tenucci.pdf>. Acesso em: 20 dez 2010.
- Coad, A. F., and J. Cullen (2006). Inter-Organizational Cost Management: Towards an Evolutionary Perspective. *Management Accounting Research*, 17, 342–369.
- Cooper, R., and R. Slagmulder (1998). The Scope of Strategic Cost Management. *Management Accounting (USA)*, 79, 18–19.
- Cooper, R., and R. Slagmulder (1999). *Supply Chain Development for the Lean Enterprise: Inter-organizational Cost Management*, Portland: Productivity Press.
- Cooper, R., and R. Slagmulder (2003). Strategic Cost Management: Expanding Scope and Boundaries. *Journal of Cost Management*, January/February: 23-30.
- Cooper, R., and R. Slagmulder (2004). Inter-Organizational Cost Management and Relational Context. *Accounting, Organizations and Society*, 29, 1–26.
- Coulter, M. (2002). *Strategic Management in Action*. Second edition. Prentice Hall, Upper Saddle River, New Jersey.
- Dekker, H., and P. Smidt (2003). A Survey of the Adoption and Use of Target Costing in Dutch firms. *International Journal of Production Economics*, v. 84, n.3, 293-305.
- Djuričin, D. and S. Janošević (2005). *Strategijski menadžment*. Centar za izdavačku delatnost Ekonomskog fakulteta u Beogradu, Beograd.
- Domanović, V. (2010). *Balanced Scorecard – mogućnosti i efekti primene*. Ekonomski fakultet, Kragujevac.
- Fayard, D., Lee, S. L., Leitch, A. R., and W. J. Kettinger (2012). Effect of Internal Cost Management, Information System Integration, and Absorptive Capacity on Inter-organizational Cost Management in Supply Chains. *Accounting, Organizations and Society*, 37, 168-187.
- Grant, R. M. (1998). *Contemporary Strategy Analysis: Concepts, Techniques, Applications*. Blackwell Publishers Ltd., Oxford.
- Guilding, C., Cravens, K. S., and M. Taykes (2000). An International Comparison of Strategic Management Accounting Practices. *Management Accounting Research*, v.11, n.1, 113-135.
- Hammer, M., and J. Champy (1993). *Re-Engineering the Corporation*. Harper Press. New York.
- Hitt, A. M., Ireland, D. R., and E. R. Hoskisson (2001). *Strategic Management: Competitiveness and Globalization*. South-Western College Publishing.
- Kaplan, R. S., and D. Norton (1996). *The Balanced Scorecard*. Harvard Business School Press, Boston, MA.
- Kaplan, R. S., and R. Cooper (1997). *Cost and Effect*. Boston: Harvard Business School Press.
- Kaplan, R. S., and V. G. Narayanan (2001). Measuring and Managing Customer Profitability. *Cost Management*, 15, 5–15.
- Lynch, R. (2000). *Corporate Strategy*. Second edition. Pearson Education Limited.
- McGahan, A. M., and M. E. Porter (1997). How Much Does Industry Matter Really? *Strategic Management Journal* 18 (Summer).
- Noordin, R., Zainuddin, Y., and M. Tayles (2009). Strategic Management Accounting Information Elements. *Management Accounting Journal*, v.4, n.1, 17-34.
- Porter, M. E. (1980). *Competitive Strategies: Techniques for Analysing Industries and Competitors*. The Free Press, New York.
- Porter, M. E. (1985). *Competitive Advantage: Creating and Sustaining Superior Performance*. The Free Press, New York.
- Prahalad, C. K. (1998). Managing Discontinuities: The Emerging Challenges. *Research Technology Management* 41(3), 14-22.

## STRATEGIC COST MANAGEMENT AS A REPLY TO CHALLENGES OF MODERN BUSINESS ENVIRONMENT

---

- Schulze, M., Seuring, S. and C. Ewering (2012). Applying Activity-Based Costing in a Supply-Chain Environment. *International Journal of Production Economics*, 135, 716-725.
- Shank, K. J., and V. Govindarajan (1993). *Strategic Cost Management: The New Tool for Competitive Advantage*, Free Press.
- Stojanović Aleksić, V. and V. Domanović (2012). Uticaj promene poslovnog ambijenta na stilove liderstva. In: *Institucionalne promene kao determinanta privrednog razvoja Srbije* (V. Leković, ed.), Ekonomski fakultet Univerziteta u Kragujevcu, 295-308.
- Waweru, N. M., Hoque, Z. and E. Uliana (2005). A Survey of Management Accounting Practices in South Africa. *National Journal of Accounting, Auditing and Performance Evaluation*, v.2, n.3, 226-263.
- Wise, R., and Baumgartner (1999). Go Downstream: The Profit Imperative in Manufacturing. *Harvard Business Review*, September-October: 133-141.

# PERFORMANCE MANAGEMENT OF SMALL AND MEDIUM ENTERPRISES IN THE FUNCTION OF ACHIEVING OF SUSTAINABLE DEVELOPMENT

Tatjana Stevanović<sup>1</sup>

Marija Petrović-Randelović<sup>2</sup>

**Abstract:** *As one of the key sustainable development challenges, poverty reduction is in the functional dependence of inclusive economic growth to which achieving can contribute the small and medium enterprises (SMEs) sector. The possibility of using the SMEs potential for development purposes derives from their specialty to accomplish the function of the source of new employment and, accordingly, reduce poverty and increase social welfare. By the analysis of the SMEs sector role in sustainable development, the aim of this paper is to contribute to understanding of its importance in achieving of sustainable economic growth and productive employment, and to indicate on the importance of managing SMEs performance in a way that contributes to sustainable development. Special attention will be devoted to achieved level of the SMEs sector development in Serbia, and providing the recommendations regarding the desired state authorities activities towards creating a stimulative business environment so the objectives of inclusive growth and productive employment become feasible.*

**Keywords:** *SMEs, sustainable development, performance management, Serbia.*

## Introduction

In the last decade of the 20th century recorded the expansion in economic activities of SMEs. Moreover, researches has found that the rate of employment growth was much higher in small than in large enterprises, but that is also recorded the noticeable growth of SMEs in the world. All this indicates that the SMEs sector in the last decade of the 20th century has taken a high place on the development agenda of many countries, particularly in developing and countries in transition.

SMEs are attributed today the role of one of the key factors in the intensification of the economic growth pace and encourage economic development of developed as well as developing and countries in transition. Because this sector has a key role of one of the bearer of faster development and new employment, rightly to it is assigned a significant role in achieving the goals of sustainable development.

Fixed size of the ecosystem put a limit on the volume of the economic system. Ecosystem limits the increase of economic systems in terms of demand for raw materials and energy, and waste streams. This means that economic systems can not increase indefinitely, but to achieve a sustainable volume of economic activity at which ecosystems will not suffer too much pressure. The SMEs sector have along with the increase of global awareness of the importance of sustainable development, turned to the definition of such business strategies that respect the basic principles which underlying this concept. Economic and environmental principles are equally relevant for solving the resource management problem. Sometimes, these principles are in conflict, but the specific issues of resources and the environment should consider how best to both of them use. Ecological-efficiency concept describes a vision for the production of economically valuable goods and services while reducing the ecological impacts of production.

Business has used a number of tools to implement these concepts, including Environment Health & Safety auditing, the Business Charter for Sustainable Development of the International

---

<sup>1</sup> Faculty of Economics, University of Niš

<sup>2</sup> Faculty of Economics, University of Niš, marija.petrovic@eknfak.ni.ac.rs

## **PERFORMANCE MANAGEMENT OF SMALL AND MEDIUM ENTERPRISES IN THE FUNCTION OF ACHIEVING OF SUSTAINABLE DEVELOPMENT**

---

Chamber of Commerce, and the Environmental Management System standards, which originate from an idea of the World Business Council for Sustainable Development. Today, SMEs management is focused on developing and implementing a business strategy which embraces the imperative of sustainability.

In accordance with the laid objective, this paper is structured as follows. After introductory considerations, the attention will be focused on explaining the importance of integrating sustainability issues into business management. Further, it will be discussed the importance of development of sustainable SMEs sector, and then will be analyzed the achieved level of SMEs sector development in Serbia. In the final part will be synthesized the research results.

### **Involvement of sustainability issues in business management**

Globalized and liberalized environment completely changed the traditional concept of companies management. In this respect, modern businesses require to be managed on the basis of target cost, the temporal discontinuity and forecasting the crisis. Management of these companies accepts these concepts, apply them successfully and improved. (Novičević, Antić, Stevanović, 2006)

The result of the internationalization of business is the sale price of a single product. In the modern economy is becoming less usable process of arriving at the selling price by adding the profit on the cost. Product price is the limit, the profit is committed by long-term corporate strategy, and cost becomes a subject of interest for management accountants in an entirely new way.

Products designed with the target selling price requires the design process that will lead to such products. At the analysis of these processes, managers need expert support in various fields of science, especially the field of measurement of inputs, or measurement of resource costs for the first time to appear. Such knowledge is needed from the time of product design, and stage of its conception, and during all the “upward” phase to after-sales service and abandonment of the product. In such circumstances it is important to identify the causal relationship between non-financial data and costs. To this end, management accounting has researched and developed a unique instrument that monitors the costs of the activities within a process.

Business events are taking place in modern conditions during the period of time longer than one fiscal year. The basis for the determination of the time horizon is now the product life cycle. Since each project has its own life cycle, managers need to look at multiple time horizons. Therefore, it is necessary to research and development of specific systems of aggregating the value to projects by time given for the purpose of regular annual, semiannual and quarterly reporting.

In conditions of high business uncertainty, management accountants are oriented towards the so-called “sliding” and reactive predicting, as opposed to budgeting the widely used simulation models, mathematical rationality, which are already at the time of making rebuttable in initial presumptions. In this context, a manager, sales managers and workers must learn the art of timely and adequate response to all possible situations during the manufacture of products in their full consent.

Creating a balanced performance measurement system in terms of business and enterprise management as described above, is associated with compiling the so-called Balanced Scorecard. This is because the organizing and promotion of this instrument solve two basic business problems. First of all, solves the problem of successful implementation of strategies, and on the other, determines the effective and efficient performance measurement system. By its nature, the Balanced Scorecard means carefully selected set of measures arising from the strategy of an organization. As a means of communicating managers with employees and external stakeholders, it determines the framework of management activities and contributes to a more balanced vision of performance. (Mendoza, 2002)

Balanced Scorecard measures the performance of companies in four areas of management: finance, customers, internal business processes and innovation and learning. Therefore, for each management area is necessary to identify the main objectives and translate them into specific measures. The choice of performance measures depends on the particular company, the period referred, and the adopted strategy.

Each of these levels has its own specific role. Thus, in terms of financial management evaluates profitability of a company strategy. This area also represents the shareholders or owners. The main task in this area is to provide a return on shareholder investment.

Manage customers, however, identify target market segments and measure the success of companies in these segments. It is associated with the creation of greater value for customers through innovative and high quality products and services at low prices. Balanced Scorecard in this area highlights the part of company strategy that is focused on providing value to consumers.

The area's internal business processes focused on the value chain of a company. Tasks in this area relate to issues of efficiency of value creation and quality. Performed activities must be analyzed to determine does that add value and discovered the most efficient manner of their execution.

Innovation management is the foundation of company infrastructure. An organization needs the right people, systems and equipment that will enable the achievement of objectives. Without learning and innovation within the company it is impossible to adapt the dynamic environment, with one hand. On the other hand, successful adaptation to change requires ongoing training, staff training, appropriate technology and information systems, and other resources to meet the new needs of consumers.

From an environmental perspective, the advantage of balanced performance measurement system consists in its pointing out the relationship between long-term resources and capabilities, including sustainability issues, and short-term financial results. The merely existence of chains of cause and consequence between resources geared towards sustainability, capability and appropriate activities discourse that the Balanced Scorecard should not only make environmentally induced costs, but all direct and indirect outcomes as important performance measures. In such circumstances, the term "balanced" is broaden on the purpose and goals of corporate sustainability. By introducing such modifications inside the concept of Balanced Scorecard opportunities for the development of the Sustainability Balanced Scorecards-SBSC are created.

Sustainability Balanced Scorecard provides management with simultaneous improvement of environmental, social, and financial business goals. "The most popular formulation for this new view of performance is the Triple Bottom Line" (Dan Montgomery, Rohm, 2000). It "involves planning, managing, and reporting on business results in three areas:

- Economic: sales, profits, ROI, jobs created, cash flow
- Environmental: impacts on air, water, waste, biodiversity, energy use
- Social: product responsibility, community impacts, labor practices, human rights" (Dan Montgomery, Rohm, 2000).

SBSC meet a central requirement of the concept of sustainability related to the continuous improvement of business performance in all aspects of sustainable development. Special eligibility of the concept of BSC to integrate all three dimensions of sustainability resulting in a position to consider the "soft" factors, which can be expressed financially. Those characteristics have environmental and social aspects. Therefore, SBSC help implementing factors such as environmental or social goals within the core of business management. (Figge, Hahn, Schaltegger, Wagner, 2002)

## **PERFORMANCE MANAGEMENT OF SMALL AND MEDIUM ENTERPRISES IN THE FUNCTION OF ACHIEVING OF SUSTAINABLE DEVELOPMENT**

---

There are several ways in which sustainability issues can be included within the concept of Balanced Scorecard. One possible way refers to the redesign of existing perspectives, the second refers to the addition of key new perspectives and the third indicates on the possibility of formulating specific environmental, or social Scorecard. Regarding the first possible way it is important to notice that redesign does not significantly affect the schedule perspectives in the Balanced Scorecard. It is approved in practice that such approach enables the inclusion of the issues of sustainability that have direct importance on the financial, customer market, supplier market, apropos on the labour market.

In the process of building the SBSC, a formulation of derived Scorecard is thus only possible second step. The initial step should be the strategic inclusion of inherently environmental and social aspects into the entity of BSC by assistance of first two alternatives. The first two alternatives in the SBSC creating are not intercourse disconnect. The distinction discovers principally in the characteristics of the important strategic environmental and social aspects. For involved environmental and social aspects in the market system (for example, environmental protection costs), it is quite easy to comprehend them using proper measures into one of four conventional perspectives. Conversely, if environmental and social aspects exercise strategic influence through mechanisms that act in the company's non-market ambient (for example, appeal of the local population), an extended perspective is required.

In the literature there are many practical examples of BSC implementation process, the most adequate for large companies. Commercial applications may be too expensive or too difficult for small and medium enterprises, and is publicly available free software is a good way to start developing a performance measurement system with them.

For SMEs the vision and strategy are not always rigorously documented, organizational culture and management culture is different than the big companies, it is difficult to retain competent staff with serious resource constraints and the current status is very dependent on the aspirations, goals and experiences of owners or managers. Selection and implementation of competitive strategies in the center of activity of entrepreneurs, but is still unaware of the strategic management process. Most SMEs operate with poor planning and forecasting systems and subject to failure in business largely due to poor risk management, inadequate decision-making and implicit implementation of strategic planning. (Jarkko Tenhunen, Juhani Ukko, Tapio Markus, Rantanen, 2004)

### **The importance of development sustainable SMEs sector**

The analysis of the SMEs sector importance for sustainable development is useful to start with the definition of this sector within the largest and deepest integration in Europe. At the same time, it should not ignore the fact that there are many definitions of SMEs, which differ from country to country, primarily because of differences in criteria on which is based their definition, for example, the number of employees, the amount of annual turnover, amount of invested capital, nature of business or a combination of two of these criteria or more.

Within the European economy SMEs play a central role as a source of entrepreneurial skills, innovation and employment. This is approved by the fact that, “there are 20.8 million small and medium-sized enterprises (SMEs) in the European Union, representing 99% of all businesses and providing around 90 million jobs in the internal market. SMEs are the backbone of the European economy and their contribution is essential for pursuing the goals of ‘Europe 2020’, the strategy for smart, sustainable and inclusive growth” (European Commission, 2012). Within the unique internal market, free of barriers, of essential importance for improving the SMEs effectiveness and minimizing the risk of distortions in the market due to the competition is existence of a single definition of SMEs.

The new definition of SMEs, which entered into force on 1 January 2005, represents a key element in creating an enabling business environment for SMEs, confirming at the same time the



readiness of the European Commission to support the development of this sector to achieve sustainable growth, productive employment and social cohesion. Taking into account the criteria, such as staff headcount, annual turnover, and annual balance sheet, the European Union defines SMEs as “the category of micro, small and medium-sized enterprises consists of enterprises which employ fewer than 250 persons and which have either an annual turnover not exceeding 50 million euro, or an annual balance sheet total not exceeding 43 million euro” (European Commission, 2012).

Sustainable development is at the centre of development endeavor throughout the developed, as well as developing and countries in transition. It is of paramount importance for the sustainable future of developing and countries in transition to create new industries that efficiently use the local resources and apply clean technologies in order to increase productivity, and to make products and provide services on the way that satisfy the fundamental people needs without destroying the environment.

The concept of sustainable development has been presented internationally with the main aim to improve the prospects of the future and make the future feasible. “Enterprises are the production organisations in which consumer needs are reflected in products and services through the use of information, human capacity and natural resources. They determine and affect all the stages of the flow of resources through society. They shape, with their networks of customers and suppliers, the overall life cycle of materials. Therefore, in the transition to sustainability, the role of such enterprises is crucial” (Van Weenen, 1999).

Despite the numerous differences in the definition of SMEs as business entities, their goals and mission, the researches showed the existence of several essential characteristics of sustainable SMEs, which include the following:

1. “Focus on elementary needs: the SME presents original or new, more sustainable solutions than those that prevail in the market.
2. Sustainable resources: the SME has a long tradition of sustainable use of resources.
3. Integration of concepts: social, economic, health, safety and environmental aspects are integrated within the SME.
4. Local adoption of sustainability: the SME in its local context aims for sustainability by incorporation of sustainable development as a holistic concept.
5. Local or regional initiatives: more general sustainable SME practice exists or is in development as part of a local or regional initiatives. It marks the beginning of local or regional sustainable industrial development” (Van Weenen, 1999).

To become sustainable, one enterprise is faced with the problem of selection the manner on which it will achieve sustainable production of goods and services. This immediately suggests that the integration of the concept of sustainability in all activities of the company withal requires also the integration of traditional business goals, such as maximizing profits, with the goals of sustainable production and consumption.

In the contemporary competitive global business environment, development of dynamic and flexible SMEs sector implies a change in its fundamental mission: from production to meet the needs in a sustainable manner. It immediately shows that those enterprises that followed with the concept of product's life cycle (from resource extraction to waste product disposal) will have to pay the attention to fulfillment cycle (taking into the account value, needs, response and fulfillment). Besides, SMEs must incorporate the sustainability requirements into their future policy and practice.

The global transformation of unsustainable models of production and consumption into the sustainable models of growth and development involves the increasing role of SMEs sector in undertaking environmentally friendly and socially acceptable activities. SMEs can contribute to the

## **PERFORMANCE MANAGEMENT OF SMALL AND MEDIUM ENTERPRISES IN THE FUNCTION OF ACHIEVING OF SUSTAINABLE DEVELOPMENT**

---

future environmental improvement only in a manner that involves using the environmentally sound technologies in the production process. Orientation towards the implementation of cleaner production models can bring many benefits to SMEs through improving their market share and increase profitability.

Adopting the practice of self-regulation proved to be an effective way to control the environmental impact of SMEs activities. Today, environmental management systems (EMS) rightly occupy a significant place among the mechanisms for improving the production process sustainability. Starkey (Starkey, 1998) points out the existence of the numerous advantages of introducing EMS in SMEs sector:

- Cost Saving
- Ensuring legislative compliance
- Anticipating future legislations
- Reduce environmental risk
- Meeting supply chain requirements
- Improved relations with regulators
- Improved public image
- Increased market opportunities
- Employee enthusiasm.

Besides of the EMS, the International Organization for Standardization (ISO) during 1993 introduces a set of instruments to support environmental management, including, Environmental auditing, Environmental labeling, Life cycle assessment, and Environmental indicators.

In order to increase the contribution of companies, both in private and public ownership, to social aspects of sustainable development was introduced International Standard of ISO 26000 : 2010. The importance of its introduction into one enterprise is reflected in the possibility of realization many benefits of socially responsible business practices, including increasing competitiveness, enhancing reputation, maintenance of employees morale, commitment and productivity, increase trust and strengthen relationships with competent state authorities.

In the Report of the European Commission are resented the results of the Flash Eurobarometer 342 survey, that are carried out between the 24th of January and the 10th of February 2012. The main findings of this survey according the areas of SMEs activities are as follows (European Commission, 2012):

a) Regarding the area of resource efficiency:

- 93% of EU SMEs report that they are taking at least one action to be more resource efficient;
- 35% of EU SMEs indicate that measures to improve resource efficiency have reduced the production costs, while 27% report that their production costs are increased;
- Regarding more specific actions linked to resource efficiency, 25% of EU SMEs report they have an environmental management system in place in comparison to 48% of large companies.

b) Regarding the area of green markets:

- Over a quarter (26%) of EU SMEs offer green products or services, their green sales represent 1-5% of their annual turnover (30%), and half (52%) of them offer products and services with environmental features.

- Food and beverages (25%) and electronic and mechanical machinery and equipment (23%) are the most commonly sold green products and services among SMEs.
  - Customer demand plays a major role in the decision to sell green products or services.
  - Half (49%) of the SMEs that already offer green products or services indicate that financial incentives would be the best way to help the expansion of their range of green products or services.
- c) Regarding the area of green jobs:
- 37% of SMEs in the EU have employees, which may include the owner himself, working in green jobs some or all the time.

### **The analysis of achieved level of development of SMEs sector in Serbia**

Achieved results of implementation of the transition process in Serbia indicated that the period from 2000 to 2008, among other things, is characterized by rapid development of SMEs and their transformation into the most dynamic and most efficient segment of the economy. Besides the fact that this sector becomes crucial for the further rapid development of the Serbian economy, its expansion is in line with the intention of the holder of the economic policies for faster structural adjustment of the Serbian economy to requirements of the European Union and more effective involvement in the European integration process.

This confirms the analysis of level of development of SMEs, which shows that this sector increasingly become more dynamic and the most vital segment of the economy, and plays an important role in the implementation of initiated structural reforms in Serbian economy. According to data for 2008, “it is estimated that SMEs sector participated with about 35% in the GDP of the Republic, and 43.2% in total employment. Foreign trade activities of SMEs in 2008 accounted for 45.5% of exports and 59.3% imports of the Serbian economy. This sector (302 449 businesses entities) is in 2008 made 66.6% of total turnover and 59.1% of GVA and 57.8% of the profits of non-financial sector“ (Republika Srbija, Ministarstvo finansija, 2009). Besides of the dominant share of SMEs in the total number of active enterprises (around 99%), the importance of this sector for achieving sustainable growth and development of Serbian economy confirms its contribution to new job creation and raising the employment.

During 2009 is recorded the slowed development of SMEs primarily arising from the negative effects of global financial and economic crisis. The crisis was negative burden the entrepreneurial climate in Serbia, caused a slowing of entrepreneurial dynamics and restricts the opportunities for job creation and productivity growth. Owing to the measures of the Serbian government for mitigation the negative effects of the crisis, in 2010 showed a slight recovery in economic activity, although the SMEs, due to a slower adaptation to new circumstances, during this year felt the severe effects of crisis.

Comparing the indicators of SMEs development in 2009 and 2010, it could be perceived that during 2010 was recorded following positive trends in this sector:

In 2009 were registered in total 315.827 businesses entities in the SME sector, while in 2010 slight increase for 3.713 resulted from an increase in number of entrepreneurs for 2.439 and micro enterprises for 1.746, while the number of small enterprises decreased by 259, and medium for 213.

1. During 2010 was a slight increase in business activity, apropos turnover in 2010 was higher by about 0.3% (in 2009 amounted to 4,380,545 mill. RSD, and in 2010 was recorded an increase on 4,677,933 mill. RSD).

**PERFORMANCE MANAGEMENT OF SMALL AND MEDIUM ENTERPRISES IN THE FUNCTION OF ACHIEVING OF SUSTAINABLE DEVELOPMENT**

---

2. During 2010 is recorded increase in export value by 15.9% and imports by 1.9% and reducing the trade deficit by 9.1% compared to 2009.

**Table 1: Comparative indicators of SMEs sector development in Serbia, 2009-2010.**  
(Ministarstvo ekonomije i regionalnog razvoja, Nacionalna agencija za regionalni razvoj, 2011, p. 14)

	<b>2009</b>	<b>2010</b>
No. of enterprises	314.827	318.540
No. of employees	872.540	814.585
Turnover (mill. RSD)	4.380,545	4.677,933
GVA (mill. RSD)	778.108	814.417
Export (mill. RSD)	275.378	339.845
Import (mill. RSD)	627.147	680.549
Balance of trade (mill. RSD)	-351.769	-340.704

Though, in 2010 the crisis has caused the following negative trends in the SME sector:

1. Since 2008, the crisis effects had a stronger expression on the reduction of the number of established businesses and stores, and increase the number of businesses entities that lay off the operations.
2. The number of employees reduced on 814.585, which compared to 2009 represent a decrease for 6.6%.
3. The crisis had adversely affected the growth of productivity, which measured by the value of GVA per employment is around 5.7%.
4. Unchanged sectoral orientation of the SMEs (Manufacturing, Wholesale and Retail Trade, Construction and Professional, scientific, and technical innovation activities) does not match the development needs of the Serbian economy, while exports, based on products of low technological intensity can not provide any desired developmental dynamics or to contribute to achieving the objectives of export-oriented growth and development.
5. Instead of stopping, in 2010 has only strengthened the regional development level differences, and the level of SMEs sector development by area. Regarding the indicator of GVA per employee, the differences in the level of the SME sector development have increased between the area with most developed SMEs sector (City of Belgrade) and the least developed sector (Pcinjska) from 2.3: 1 in 2009 to 2.4: 1 in 2010.

The analyzes show that SMEs sector plays an important role in achieving sustainable development of Serbian economy, especially if it takes into account the participation of this sector in the creation of GDP and employment. The crisis is not only negatively burdening the business environment for SMEs, but also limited reacts on solving the key problems with which is facing the sector. One of the “burning issues” relates to the still uncompleted institutional and regulatory environment that acts as a key barrier to creating new businesses and jobs.

Creating an enabling environment for development of the sustainable SMEs sector requires taking the activities of the state authorities that could be summarized as follows:

1. Creation of an adequate system of incentives and addressing the key problems of enterprise development at the stage of growth and development, regarding the practice of highly developed countries of the OECD and the EU.
2. Support the fastest development of SMEs through the implementation of the Strategy of competitive and innovative SMEs in order to create conditions for development a competitive and on knowledge and innovation based SMEs sector, which contributes to achieving the national goals of sustainable development.
3. Changes the funding methods towards strengthen the public-private partnership.
4. Encourage the development of dynamic entrepreneurship that guarantees sustainable economic growth.
5. Taking the measures and activities towards improving the regulatory and administrative environment for the establishment and operation of new enterprises, in order to provide necessary support for the development of sustainable, competitive and export – oriented SMEs sector.

### **Conclusion**

The SMEs sector, by performing the function of the instrument for reducing the poverty through the creation of new jobs, is now considered as the bearer and the world promoter of sustainable growth and development. There are many benefits which development of this sector can bring to the developed, and especially developing countries, ranging from job creation and, accordingly, increase employment to the collecting benefits on the basis of the economies of scale effects.

In order to maximize benefits of the SMEs sector development the government of developing countries and countries in transition and SMEs themselves are faced with numerous challenges, including:

1. Encourage the SMEs sector development by creating a favorable business environment that will be enough persuasive for the development of new enterprises, in order to minimize the proportion of these enterprises in the informal sector of economy.
2. Increasing the SMEs sector competitiveness and productivity.
3. Achieving that level of competitiveness that will enable SMEs to efficiently integrate into the global value chains through trade and foreign direct investment.

Multi-dimensional character of these challenges require an orientation the SMEs efforts towards the creation such management system of their performance that will enable the achievement of greater value to consumers with lower environmental impacts. Besides of increasing SMEs flexibility and adaptability to market conditions and consumer demands, of key importance for the sustainable survival of these enterprises on the market is their compliance with the higher technical (par example, technical barriers to trade), environmental (par example, ISO14000) and labor standards in local and foreign export markets. In addition, the development of cooperative relationships with multinational corporations is a prerequisite of inclusion in a global sales network and collection of benefits arising from these relationships, which are essential for improving their business performance in terms of sustainable development.

## PERFORMANCE MANAGEMENT OF SMALL AND MEDIUM ENTERPRISES IN THE FUNCTION OF ACHIEVING OF SUSTAINABLE DEVELOPMENT

---

### References

- Dan Montgomery, D. and H. Rohm (2000). *Link Sustainability to Corporate Strategy Using the Balanced Scorecard*. Regency Parkway, Suite 425, Cary: USA. (1.3.2012.) <<http://www.balancedscorecard.org>>.
- European Commission. (2012). *SMEs, Resource Efficiency And Green Markets*. Flash Eurobarometer 342 - TNS Political & Social.
- Figge, F., T. Hahn, S. Schaltegger and M. Wagner (2002). The Sustainability Balanced Scorecard – Linking Sustainability Management to Business Strategy. *Business Strategy and the Environment*, Vol. 11, pp. 269–284.
- International Guidance Document. (2005). *Environmental Management Accounting*. International Federation of Accountants.
- Marko Tenhunen, J., J. Juhani Ukko, M. Tapio Markus and H. Rantanen (2004). Applying Balanced Scorecard Principles on the SAKE-system: Case Telekolmio Oy. Department of Industrial Engineering and Management, Lappeenranta University of Technology, Kasarmikatu 4, Finland.
- Mendoza, C. (2002). *Tableau de Bord et Balanced Scorecard*. G.R.E., Paris.
- Ministarstvo ekonomije i regionalnog razvoja, Nacionalna agencija za regionalni razvoj. (2011). *Izveštaj o malim i srednjim preduzećima i preduzetništvu za 2010. godinu*. Beograd.
- Ministry of Economy, Trade and Industry. (2009). *Environmental Management Accounting (EMA) Workbook*. (10. Sept. 2010.). <[http://www.meti.go.jp/policy/eco\\_business/pdf/workbook.pdf](http://www.meti.go.jp/policy/eco_business/pdf/workbook.pdf)>.
- Novičević, B., Lj. Antić and T. Stevanović (2006). *Upravljanje performansama preduzeća*. Niš: Ekonomski fakultet.
- Republika Srbija, Ministarstvo finansija. (2009). *Izveštaj o razvoju Srbije 2008*. Beograd.
- Starkey, R. (1998). *Environmental Management Tools for SMEs: A Handbook*. European Environment Agency: The Centre for Corporate Environmental Management (CEM).
- Van Weenen, H. (1999). *Design for Sustainable Development: Practical Examples of SMEs*. European Foundation for the Improvement of Living and Working Conditions.

# INVESTIGATING CORPORATE ENTREPRENEURSHIP IN SERBIAN CONTEXT

Ljiljana Kantić<sup>1</sup>

**Abstract:** *This paper presents an empirical research and analysis of corporate entrepreneurship within Serbian organisations. The previous study revealed that Corporate Entrepreneurship Assessment Instrument (CEAI) (Hornsby, Kuratko & Zahra, 2002) should be modified in order to be used in Serbian context. The author proposes scale with 41 items in five dimensions (managerial support, rewards, responsibility and job descriptions, decision making and available time). The main aim of the study is to test the validity of modified questionnaire in selected organizations. Respondents were 355 employees with different demographic variables. The research findings revealed on practical implementation of proposed questionnaire in Serbian environment. An innovative organizational culture in Serbian organizations could be determinate with proposed five factors. The findings have significant implications for practitioners attempting to manage change effectively. The research limitations are suggested.*

**Keywords:** *corporate entrepreneurship, innovative organizational culture, Serbia*

## Introduction

The concept of corporate entrepreneurship has not universally accepted name. Therefore, there are different terms in the literature such as an investment and intra entrepreneurship (Hornsby et al., 2002). Corporate entrepreneurship encompasses situations that arise when embarking into new forms of business, while introducing new ideas into the organization and the basic idea that covers the entire business. This entrepreneurship emphasizes the increasing ability of organizations to adopt and develop innovative and creative abilities.

The significance of this research is primarily scientific in nature. This paper is intended to develop an understanding of corporate entrepreneurship in Serbian environment and its conditionality demographic characteristics and features of the organization. In addition, the study replicated and extended previous research, which confirmed the validity of the research instrument (Kontic, 2011).

The main objective of this study was to determine the suitability of a modified version of the questionnaire for measurement corporate entrepreneurship in a transforming economy. An additional objective was to examine how demographic characteristics of respondents influence the occurrence of corporate entrepreneurship. In order to achieve the goal, following research questions have formulated:

1. What is the relationship between the education level and managerial level?
2. Does modified questionnaire explain corporate entrepreneurship in Serbian organizations?
3. Are there differences of a survey of corporate entrepreneurship factors regarding demographic variables?

---

<sup>1</sup> Faculty of Legal and Business Studies, Novi Sad, ljiljana.kontic@yahoo.com

### **Theoretical background**

#### ***The concept of corporate entrepreneurship***

Corporate entrepreneurship is considered as entrepreneurial activities in existing organizations. However, how and why the process of corporate entrepreneurship works remains a black box (Covin & Miles, 1999; Hornsby et al., 2002). Additionally, the researchers have used different terms to describe the entrepreneurial activities such as corporate entrepreneurship (Carrier, 1996; Covin & Miles, 1999; Covin & Slevin, 1991; Dess et al., 1999; Hornsby et al., 2002; Jennings & Lumpkin, 1989; Stopford & Baden-Fuller, 1994; Ucbasaran et al., 2001; Zahra, 1993; Zahra et al., 1999; Zahra et al., 2004), intrapreneurship (Antoncic & Hisrich, 2001; Carrier, 1996; Hostager et al., 1998), corporate venturing (Miles & Covin, 2002), and internal corporate entrepreneurship (Jones & Butler, 1992).

The construct of corporate entrepreneurship is still evolving. Therefore, there is no standard definition of the term.

Many authors argued corporate entrepreneurship has three dimensions proactivity, innovation, and risk taking (Miller, 1983; Morris & Paul, 1987; Covin & Slevin, 1990; Dean et al., 1993).

If corporate entrepreneurship activities are developed in the trend of companies mission, then there is formal corporate entrepreneurship. The informal corporate entrepreneurship occurs spontaneously.

The corporate entrepreneurial activities can be conducted within companies boundaries (internal activities) or as a joint venture (external activities).

"Entrepreneurial actions help to sustain competitive advantage for firms facing rapid changes in industry and market structures, customers' needs, technology and societal values" (Bhardwaj et al., 2011, p. 188).

The corporate entrepreneurship is a complex construct that appears in many forms. Focusing on the name and dimensions provided by different authors may cause confusion. The classification can be useful to some extent that provides us opportunity to understand different approaches and the results obtained by different authors in the research field. In the literature, there is no single or unique approach that is accurately and incorporating different forms of the corporate entrepreneurship.

"Corporate entrepreneurship includes all actions characterized by novelty in resources, customers, markets, or a new combination of resources, customers and markets" (Ireland et al., 2009).

To conclude, there is a need to analyse process and factors of corporate entrepreneurship. This is required when relative new concept is presented as background of empirical study.

#### ***Corporate entrepreneurship measures***

Corporate entrepreneurship has been operationalized in many ways. Undoubtedly, the variance in measures has contributed in some degree to the definitional gap and the labeling problem discussed in the previous section.

The first questionnaire has been focused on proactiveness, risk taking and innovation (Covin and Slevin, 1989). Other questionnaire named Corporate Entrepreneurship Assessment Instrument (CEAI) has been embodied the individual understanding of corporate entrepreneurship (Hornsby et al., 2002). Five factors revealed the existence of corporate entrepreneurship in organizations management support, work discretion and autonomy, rewards and reinforcement, time availability, and



organizational boundaries. The factor structure presented by Hornsby et al. (2002) has been tested in a few settings (Adonisi, 2003; Brizek, 2003; Wood, 2004; Rhoads, 2005; Davis, 2006).

This questionnaire was applied to a sample of local managers in four Serbian organizations. Internal reliability of CEAI measured the Cronbach alpha for the entire questionnaire was 0.927. While the results within the five subscales were 0.918 for Management support, 0.782 for autonomy, 0.743 for reward, time availability 0.465, and organizational boundaries 0.696 (Kontic, 2011). The factor analysis showed that corporate entrepreneurship has been described by 41 items. The modified questionnaire for exploring corporate entrepreneurship in Serbian context, which it used in this study, consists of five factors, namely:

- Factor 1. Management supports 14 items,
- Factor 2. Rewarding / empowering employees 10 items,
- Factor 3. Responsibility and specific job descriptions 10 items,
- Factor 4. Autonomy in decision making 2 items, and
- Factor 5. Time availability 5 items.

### **Research methodology**

The survey was conducted during March and April 2012.

The sample consisted of 355 employees from 12 organizations. There were public and private large, medium and small organizations. Following characteristics of respondents have been analyzed: gender, age, education level, work experience, and managerial position (*see Table 1*).

**Table 1. Sample structure**

<b>Characteristics</b>		<b>Percent of sample (%)</b>
Gender	Female	50.9
	Male	49.1
Age	21-30	14.6
	31-40	27.3
	41-50	35.2
	51-60	18.9
	Over 60	5.4
	Education level	High school
College degree		15.6
University degree		40.3
Master and M.A		14.4
PhD		1.1
Work experience	Newcomers	2
	1-3 years	8.5
	3-5 years	9.4
	6-10 years	17.9
	11-20 years	31.5
	Over 20 years	33
Managerial position	Non manager	70.4
	Middle management	22
	Senior management	7.6

The research instrument was modified CEAI consists of 41 Likert-type questions. The respondents were expected to determine their level of agreement on the five-level scale where 1 meant totally disagree and 5 = strongly agree.

Data analysis included frequency analysis, t-test, ANOVA, descriptive statistics, and factor analysis.

### Results

The Cronbach's alpha coefficient for the questionnaire (41 items) is 0.89, suggesting that the questionnaire has high internal consistency. The highest reliability has subscales of management support (0.93), Rewarding/empowering employees (0.823), and Autonomy in decision making (0.816). The lower reliability has subscales of Time availability (0.74) and Responsibility and accurate job descriptions (0.738). Factor 4. Autonomy in decision making can be considered as unstable because only two items describes them.

Searching for the answer on the first research question revealed that there are correlations between university degree and managerial position ( $r = 0.431$ ).

### *Factor analysis*

Prior to factor analysis, the data have been tested by Kaiser Meyer Oldkins (KMO) test and Bartlet test. It was found that a KMO is 0.907 and Bartletov test was significant at the level of 0.01.

The first analysis was singled out eight factors together explain 63.65% of variance. The factor analysis of proposed five factors showed that 54.93% of the total variance was explained by the modified questionnaire.

What happen with five factors and items that describe them in a previous study?

The factor analysis revealed significant changes in items. New Factor 1 includes all items obtained from a previous study (item 1-14) except for items 2, which has been moved to the Factor 4 and four new items (18,19,20, and 23) from previous Factor 2. New Factor 2 consists mainly of questions that correspond to previous results (item 15-24) and two items (25, 31) from Factor 3.

The Factor 3 consists of items 26, 27, 28, 29, 30, 32, 33, 34 that are obtained in the previous study with the addition of item 39.

The Factor 4 consists of items 2, 24, 35, 36.

The Factor 5 is almost identical with the last factor 5 without item 39.

Following five factors explain corporate entrepreneurship in Serbian organizations (*see Figure 1*):

Factor 1. INNOVATION,

Factor 2. RESPONSIBILITY,

Factor 3. STANDARDIZATION AND ROUTINES,

Factor 4. AUTONOMY IN DECISION MAKING, and

Factor 5. TIME AVAILABILITY.

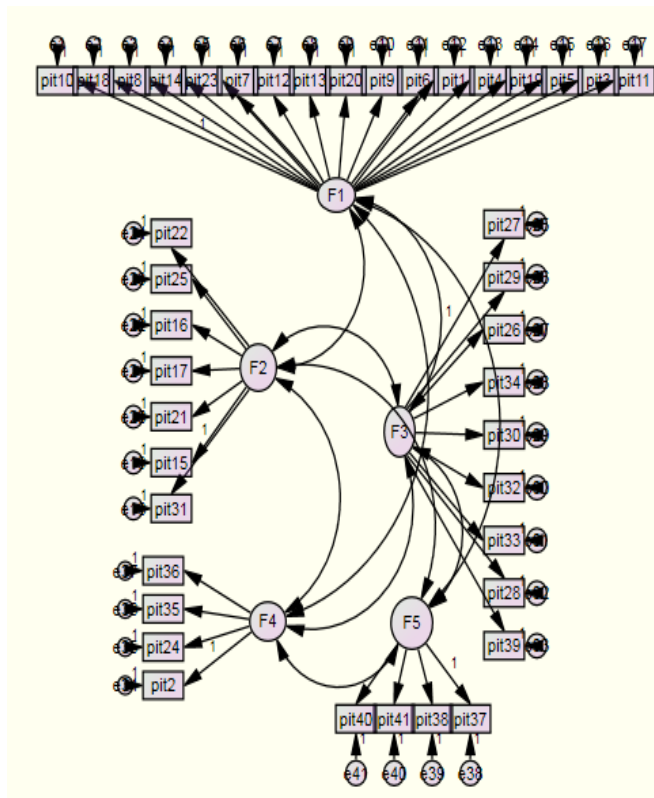

Figure 1. New factor structure

### *Results of testing differences*

The results revealed that there is a gender-based variation in respondents' ratings of innovation, responsibility, and autonomy in decision making. The male respondents gave higher ratings on aforementioned factors than their female counterparts.

*Differences by age.* It was found there are differences in respondents' ratings of new factors. The younger respondents are more supportive to innovation than older respondents. There are significant differences between the respondent in the age 31-40 and 41-60 year old respondents. These differences can not explain the linear growth of years since there was no difference between the youngest group and the other as well as the oldest and others. Factor 4 autonomy in decision making speaks of independence, and the difference between the groups shows that the youngest workers have at least scores on this factor. All these findings have been tested and validated Spearman correlation. It was found that the first two factors negatively associated with age, while others are significantly positively correlated.

*Differences by education level.* There are differences in all factors except on factor 2. Respondents with higher education level gave the higher support to innovation. The level of autonomy increases with educational level and the highest score had respondents with master degree. The differences suggest that the less educated respondents were less burdened by the time than respondents with higher education level.

*Differences by work experience.* It was noticed that there are significant differences in factor 1 and 3. It is observed that there are differences between the groups, and they are so set that can be seen,

that workers with more experience have the lowest scores for innovation support. This result goes in line with the results obtained for differences by age and other such results is reasonably expected.

*The difference between of Managers and non managers.* It was found that there were significant differences on all factors except in factor 3. Managers have significantly higher scores on factors 1, 2 and 4 while non managers are not burdened with less time.

*The difference between the middle and senior management.* Significant differences in factors 1, 2 and 4, where the senior management realized higher scores. They are estimated to have more support to innovation and independence in their work.

*Differences between private and public organizations.* There are differences in four factors except in Factor 4. The first three factors are dominant in private organizations while, in public organizations, employees are significantly less time pressure. This is consistent with the general view of the difference between the two sectors.

*Differences in size of the organization.* The existence of differences for Factors 1,3, and 4. Innovation is the highest in small organizations. Standardization and routine are least present in medium organizations. Independence is significantly higher in large organizations than on small and medium.

### **Conclusion**

Corporate entrepreneurship is considered to be poorly defined (Stopford & Baden-Fuller, 1994). The lack of framework makes difficult to study the phenomenon in a proficient way.

The study contributes to the literature on corporate entrepreneurship and organizational behavior by pointed to five factors that encourage innovation efforts. Factor analysis showed a high degree of reliability using the instrument for accelerating innovation and fostering an entrepreneurial spirit in the studied organizations. Cronbach alpha of the questionnaire was 0.89. From the perspective of management, the results show that the modified questionnaire is a valuable tool in the diagnosis of entrepreneurship organizational culture because it helps in identifying the elements of improvement and development of strategies to establish and implement innovations in organizations in Serbia.

The diversity of national cultures, led to the research instruments was created within a national culture can not fully apply to organizations that belong to other national cultures. Detailed analysis showed that the necessary modifications in respect of issues, but also in the domain of definition and content of factors. Differences in factor structure between the original CEAI and the results obtained in the Serbian organizations recognize the necessity of improvement of the research instrument in its application, in a different cultural context.

From a theoretical perspective, the study represents a significant advance in understanding the internal factors of entrepreneurship in Serbia.

The research results are applicable to the organization of a test can be applied to different national cultures or in other industries. One of the problems facing the paper is not the restriction of the sample in all groups except for gender. For T-test and ANOVA is not recommended that one group is twice larger than the other, because it increases alpha relative to its true value.

## References

- Adonisi, M. P. (2003). The relationship between corporate entrepreneurship, market orientation, organisational flexibility and job satisfaction. Pretoria: University of Pretoria.
- Antonicic, B. & Hisrich, R.D. (2001). Intrapreneurship: construct refinement and cross-cultural validation. *Journal of Business Venturing*, 16(5): 495-527.
- Bhardwaj, BR & K. Momaya (2011). Drivers and enablers of corporate entrepreneurship Case of a software giant from India. *Journal of Management Development*, 30 (2): 187-205.
- Brizek, M. G. (2003). An empirical investigation of corporate entrepreneurship intensity within the casual dining restaurant segment. Virginia: Virginia Polytechnic Institute and State University, Falls Church.
- Carrier, C. (1996). Intrapreneurship in small businesses: an exploratory study. *Entrepreneurship: Theory & Practice*, 21(1): 5-20.
- Covin, J.G. & Slevin, D.P. (1991). A conceptual model of entrepreneurship as firm behavior. *Entrepreneurship: Theory & Practice*, 16(1): 7-25.
- Covin, JG & Miles, MP (1999). Corporate entrepreneurship and the pursuit of competitive advantage. *Entrepreneurship: Theory and Practice*, 23 (3), pp. 47-63.
- Covin, JG & Slevin, DP (1989). Strategic management of small firms in hostile and benign environments. *Strategic Management Journal*, 10: 75-87.
- Covin, JG & Slevin, DP (1990). New venture strategic posture, structure, and performance: An industry life cycle analysis. *Journal Of Business Venturing*, 5(2):123-134.
- Davis, T.M. (2006). Corporate entrepreneurship assessment instrument (CEAI): Systematic validation of a measure. Ohio: Air Force Institute of Technology, Wright-Patterson Air Force Base.
- Dean TJ, Meyer, GD, & DeCastro, J. (1993). Determinants of new-firm formations in manufacturing industries: Industry dynamics, entry barriers, and organizational inertia. *Entrepreneurship Theory and Practice* , 17(2):49-59.
- Dess, GG, Lumpkin, GT, McGee, JE (1999). Linking corporate entrepreneurship to strategy, structure, and process: suggested research directions. *Entrepreneurship Theory Practice* , 23 (3):85-102.
- Hornsby, JS, Kuratko, DF, & Zahra, SA (2002). Middle managers' perception of the internal environment for corporate entrepreneurship: Assessing a measurement scale. *Journal of Business Venturing* , 17: 55-89.
- Hostager, T.J., Neil, T.C., Decker, R.L. & Lorentz, R.D. (1998). Seeing environmental opportunities: effects of intrapreneurial ability, efficacy, motivation and desirability. *Journal of Organizational Change Management*, 11(1): 11-25.
- Ireland, RD, Covin, JG & Kuratko, DF (2009). Conceptualizing corporate entrepreneurship strategy. *Entrepreneurship Theory and Practice* , 33 (1):19-46.
- Jennings, D.F. & Lumpkin, J.R. (1989). Functioning modeling corporate entrepreneurship. An empirical integrative analysis. *Journal of Management*, 15(3): 485-502.
- Jones, G.R. & Butler, J.E. (1992). Managing internal corporate entrepreneurship. An agency theory perspective. *Journal of Management*, 18(4): 733-749.
- Kotic, Lj. (2011) Istraživanje korporativnog preduzetništva u izabranim srpskim organizacijama In *Novi metodi menadžmenta i marketinga u podizanju konkurentnosti srpske privrede*, Jančićević, N. and Lovreta, S. eds, Ekonomski fakultet Univerziteta u Beogradu, Naučno društvo ekonomista Srbije, Univerzitet u Novom Sadu, Ekonomski fakultet Subotica. pp. 103-116.
- Miles, M.P. & Covin, J.G. (2002). Exploring the practice of corporate venturing: some common forms and their organizational implications. *Entrepreneurship: Theory & Practice*, 26(3): 21-40.
- Miller, D. (1983). The correlates of entrepreneurship in three types of firms. *Management Science* , 29(7):770-791.
- Rhoads, G. R. (2005). Initiating an entrepreneurial mindset in the Department of Defense (DoD): Testing a comprehensive model. Ohio: Air Force Institute of Technology, Wright-Patterson Air Force Base.

## **INVESTIGATING CORPORATE ENTREPRENEURSHIP IN SERBIAN CONTEXT**

---

- Stopford, J.M. & Baden-Fuller, C.W.F. (1994). Creating corporate entrepreneurship. *Strategic Management Journal*, 15(7): 521-536.
- Ucbasaran, D., Westhead, P. & Wright, M. (2001). The focus of entrepreneurial research: contextual and process issues. *Entrepreneurship: Theory & Practice*, 25(4): 57-80.
- Wood, C. C. (2004). Entrepreneurial mindset in Department of Defense (DoD) organizations: Antecedents and outcomes. Ohio: Air Force Institute of Technology, Wright-Patterson Air Force Base.
- Zahra, SA (1993). A conceptual model of entrepreneurship as firm behavior: A critique and extension. *Entrepreneurship Theory and Practice*, 17(4):5-22.
- Zahra, SA, Hayton, JC, & Salvato, C. (2004). Entrepreneurship in family vs. Entrepreneurship in family vs. non-family firms: A resource-based analysis of the effect of organizational culture. *Entrepreneurship Theory and Practice*, 28(4):363-381.
- Zahra, SA, Jennings, DF & Kuratko, DF (1999). The antecedents and consequences of firm-level entrepreneurship: The state of the field. *Entrepreneurship Theory and Practice*, 24(2):45-66.

# MEASURING CUSTOMER SATISFACTION

Branko Maričić<sup>1</sup>

Saša Veljković<sup>2</sup>

Aleksandar Đorđević<sup>3</sup>

**Abstract:** *Customer satisfaction is significant in business management because it represents a long-term basis for profitability of both certain lines of product and the entire company. Customer satisfaction in modern market environment is characterized by a large number of alternatives that can fulfill the same need or desire of a customer, and prerequisite for which are retention, loyalty and positive focused communication between companies and sellers on one side and customers on the other. Companies increasingly invest funds and management efforts to improve customer satisfaction. Customer satisfaction improvement implies measuring customer satisfaction and undertaking adequate marketing strategies and tactics, as well as corrective actions. The paper presents known attempts of measuring customer satisfaction on macro and micro levels of marketing analysis.*

*Customer satisfaction index is an important indicator of achieved quality and market performances of the company and can be calculated on micro and macro levels. National customer satisfaction indices are useful frameworks for competitiveness analysis of national economies, industries and individual companies. They are also used for a series of other aspects of observation and analysis. Standardization of customer satisfaction indices in different countries enables comparability of obtained data, which gives the analysis a new quality in the era of globalization and internationalization of operation.*

**Keywords:** *marketing, customers, satisfaction, measuring satisfaction, satisfaction indices*

## Customer satisfaction and significance of its measuring

Customer satisfaction is the basic goal of marketing activities of market participants. It is achieved by designing and delivering value to customers. Satisfaction is the immediate experience that customers have when purchasing and using products and services as a consequence of designed and delivered value (Johson and Wenhstein, 2007).

Customer satisfaction in modern business management is one of the key factors of increase of competitive advantage and company profitability (Maričić, 2011)

According to one of the most commonly used definitions of customer satisfaction (**S**), it is defined as a function of customer expectations (**O**) and perceptual performance of a product or a service (**P**), which can be presented by the following formula (Maričić, 2011):

$$S = f(O, P)$$

Relationship between expectations and product performances has several different relations, which directly determines the level of customer satisfaction. The first relation relates to the case when product performances are smaller than customer expectations (**O > P**), when satisfaction is negative (dissatisfaction). The second relation relates to the case when product fulfills customer expectations

---

<sup>1</sup> Faculty of Economics, University of Belgrade

<sup>2</sup> Faculty of Economics, University of Belgrade, veljkos@ekof.bg.ac.rs

<sup>3</sup> Faculty of Economics, University of Belgrade

## MEASURING CUSTOMER SATISFACTION

( $O=P$ ), when there is satisfaction and customer is mostly satisfied. The third relation relates to the case when product performances exceed customer expectations ( $O < P$ ), which is a higher level of satisfaction that can even lead to customer exhilaration.

The essence of modern marketing and business is in creating and delivering value to customers, which is in accordance to their expectations and preferences. Business management literature insists on the difference between the value marked as *needed (real)*, which customers expect from the product, and *superior value*, which is the basis for gaining competitive advantage in the market. Superior value is the one above customer expectations, which reflects more than positively to their satisfaction and enables gaining competitive advantage in the market (Milisavljević, 2010).

Satisfaction directly depends on the benefit of the product or service for customers. Product performances depend on functional, esthetic and other features of the product and quality. Value for a customer is a more complex category, which apart from the element of benefit also has elements of sacrifice, and, therefore, more precise explanation implies the expansion of observation range in satisfaction analysis (Oliver, 2002). Explanation of dependence between satisfaction and designed value requires defining the difference between expected value and supplied value. Customers make the decision on purchasing based on the expected value *Ve (value expected)*. The value they actually get is the real (supplied) value, in literature called the delivered value *Vd (value delivered)*. Relation between expected and delivered value can be different, which affects the level of customer satisfaction. Possible relations are presented in Figure 1.

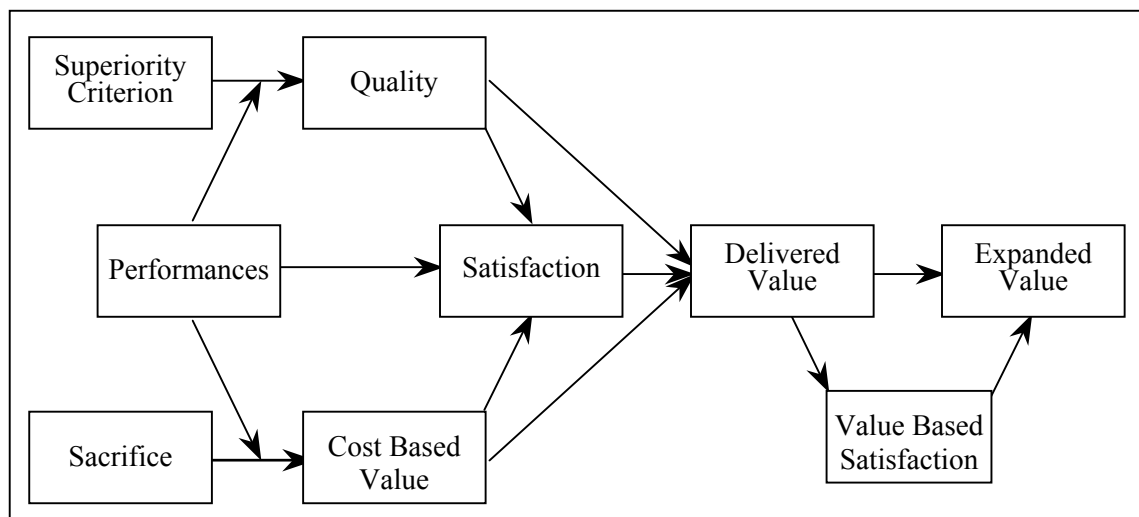

**Figure 1. Redefined satisfaction model (Oliver, 2002)**

If the delivered (obtained) value is equal and larger than expected value ( $Vd \geq Ve$ ), there is satisfaction with customers. If the delivered value is significantly larger than expected value ( $Vd \gg Ve$ ), there is superior satisfaction that, sometimes, creates exhilaration with customers. In modern marketing literature it is more and more commonly listed as the imperative for successful operation.

According to the model presented in Figure 1, there are two levels of customer satisfaction. *The first level of satisfaction* (in figure marked in square Satisfaction) has a traditional approach to satisfaction at its basis, by which the degree of customer satisfaction depends on the expectations and performances of a product or service. The difference between the first level compared to the traditional approach to satisfaction is that the customer satisfaction analysis depends on two elements:

- product features and quality, which fall into benefits; and



- sacrifice expressed through costs for customers.

Therefore, the first level of customer satisfaction depends on the expected basic value. *The second level of satisfaction* (in figure marked in square Delivered Value) is a broader concept that, apart from the basic value, also considers added values designed in different parts of supply chain. The second level of satisfaction is also called value based satisfaction and it depends on customer's expectations of total value, which is created in the entire supply chain.

Redefined approach to customer satisfaction indicates that in order to have a more complete explanation and understanding of satisfaction, having a more complex approach based on the concept of value for customers is necessary. The fact is that satisfaction needs to be explained in the context of designed value, which is confirmed by a large number of empirical researches (Zeithmal, 2008).

In modern business management customer satisfaction is one of the basic goals of marketing, but also a means to achieve other goals of operation (profit, market share, loyalty degree). Pronounced competition and high requirements of modern customers, which are increasingly becoming the feature of the Republic of Serbia's market, imposed the need of continuous improvement of quality of products and services in order to raise customer satisfaction and loyalty levels. Satisfaction is achieved if, through the value design and delivery process, customer expectations are reached or exceeded. Satisfaction is a complex category due to high heterogeneity degree of customer expectations and existence of different possibilities to satisfy these expectations.

In order to successfully manage marketing in a competitive environment and determine effectiveness and efficiency of different marketing instruments and concepts, it is necessary to measure satisfaction. It is a kind of attempt to objectivize and quantify subjective perceptions of customers. Based on results of measuring, different effects can be considered and adequate measures can be undertaken to advance operation.

Different concepts, methods and techniques have been developed to measure customer satisfaction. There are differences between micro and macro approaches to measuring customer satisfaction. Micro level of measuring satisfaction implies measuring effectiveness and efficiency of marketing participants' (e.g. companies) marketing mix. Macro level of measuring customer satisfaction relates to the degree of successfulness in satisfying needs and wishes of customers at the national economy level or industry level.

### **Measuring customer satisfaction at macro level**

Satisfaction appears as a prerequisite for successful cooperation between customers and companies in pronouncedly competitive conditions of modern operation. From macro perspective, in national economy, this data says of the way economy operates with respect to customer satisfaction, but also of the differences between certain sectors, as well as specific companies (competitors), from the aspect of ability and the way to fulfill (meet up to a certain level) the needs and wishes of customers. Apart from this, at the national economy level, based on the value of customer satisfaction index, it is possible to foresee movement of gross domestic product and personal consumption, but also to which percent is price increase of a certain product caused by quality improvement, rather than inflation rate increase. This is why national barometers (measurement scales), or customer satisfaction indices, have great significance for designers of macroeconomic policy of a country. According to some authors, productivity shows quantitative aspect of operation of a company and the entire national economy, and customer satisfaction indices show the quality of these relations (Fornell, 1992). It might be inferred that models for monitoring customer satisfaction on macro level are being developed to promote quality and make economy more competitive, that is to monitor the "health" of the national

## MEASURING CUSTOMER SATISFACTION

---

economy and certain sectors, as well as the way of fulfilling primary objectives of operation regarding satisfaction of customers' needs and wishes.

Due to everything aforementioned, the growing interest in monitoring satisfaction at macro level is not surprising, which was reflected in a large number of established models in different countries of the world. These models have been particularly intensively developed for the past twenty years. They have great significance at national economies level, but also at the level of industries and individual companies. Although there still is not the generally accepted global model, the trend of increasing globalization and standardization when it comes to national barometers is noticeable. They often, despite certain differences, have a lot of similarities. The reason for this may be the fact that customer satisfaction has universal meaning, but also that later developed models usually started from some previously developed model, i.e. they represent its improved version.

Application of identical model in different industries of different countries has the key advantage in comparability of obtained data, which is a prerequisite for improvement of customer satisfaction, company's market performance and general economic condition of a specific state, but also beyond that. Therefore, the general trend of globalization and internationalization, as well as associations of countries (like European Union expansion), also had an impact on the measuring area of customer satisfaction at macro level. Besides, some of the models for monitoring customer satisfaction at the national level present a basis for monitoring in different countries, whether by purchasing of license or by cooperation with experts who originally developed these models.

From historical perspective, the first attempt to create overall national model for measuring customer satisfaction was realized in Sweden in 1989 (*Sverige Kundbarometer*). The research team lead by professor C. Fornellom developed the *Swedish Customer Satisfaction Barometer-SCSB*, examined in the first year (1989) in 28, and next year (1990) in 32 industries of Swedish economy (Johnson, Gustafsson, Andreassen, Lervik, Cha, 2001). The basic goal was to monitor and compare satisfaction indices between separate industries, and, apart from that, to: compare results of a specific company with industry average; compare results in different time intervals; foresee long-term results and effects; and get answers to various questions, like those on sensitivity of certain industries (and companies) to customer satisfaction, on effects of total quality and prices, on impact of customer expectations to satisfaction, on impact of customer complaints and effects of oral propaganda, etc (Fornell, 1992).

Among the first attempts of measuring customer satisfaction at the national level, the German barometer (*Deutsches Kundenbarometer - DK*) needs to be mentioned, which was made in 1992, at the initiative of the *German Marketing Association*, and with the support of *DeutschePost*. German satisfaction barometer was established as a result of power and development of customer orientation of German industries and companies. The model provides basis for continual monitoring and improvement of satisfaction of German citizens. This model includes over 50 branches of German economy into the research. About 45,000 interviews annually are performed by this model using CATI technique (Grigoroudis and Siskos, 2004). German barometer is methodologically significantly different than other national models. In this model customer satisfaction is measured by one claim only (total customer satisfaction with a product/service). Apart from this, there is no causality system between examined variables, so *Deutsches Kundenbarometer* cannot be said to represent a model in a classic meaning of the word (Johnson, Herrmann and Gustafsson, 2002).

After first attempts, during the last decade of the past century similar efforts to establish a customer satisfaction measuring system at the national level were made by countries such as the USA, Singapore, certain countries of the EU, Switzerland, New Zealand, Taiwan, etc. It is interesting that, for example, New Zealand, South Korea, Malaysia and Taiwan fall among the group of countries that defined and tested their own national models, while most other countries accepted some of previously developed models, primarily American (ACSI) and European (ECSI i.e. EPSI), which have broadest

application in their original or adapted version (Bruhn and Grund, 2000; Grigoroudis and Siskos, 2004).

*American Customer Satisfaction Index* has made huge success and has broad application. Hence, only in the last few years several countries has initiated and formed their own customer satisfaction indices using the license of the founder of this index. It is interesting that experts who developed the model in Sweden participated in the realization of the American model. It is precisely based on the Swedish model that a team of Professor C. Fornella established the *American Customer Satisfaction Index* (ACSI). The model is a joint work result of the American Society for Quality and experts from the University of Michigan. Initial version of the American model was examined in 1994. Since 1996, the necessity of separate measuring of product quality and service quality has been emphasized by this model. The fact that this model, as of recently, is being applied in Great Britain, that in Singapore they have been working by this model since 2008, and that the *Turkish Customer Satisfaction Index* – TMME started the application in 2005, speaks of its popularity (Veljković and Marinković, 2010). The latest testing and application of ACSI index are related to Indonesia, Brazil, Malaysia, South Africa and Portugal(www.theacsi.org).

In the end of nineties of the XX century, the *European Customer Satisfaction Index* (ECSI), which connects image, customer expectations, perceived quality and value, all leading to customer satisfaction. The model was made in such a way to enable calculation and comparisons at the company, industry or state level (Cassel and Eklof, 2001).

ECSI is essentially the adaptation of the American model to the European environment. The first results of a study performed in 11 countries of the European Union were presented in 2000. Certain European countries, such as France, Denmark, Switzerland, Norway, Austria and the Netherlands, formulated their own national indices as well. Today, European index is being examined and kept in over 20 countries, and separate studies using this index are being done for 15 countries. In most countries it is now called *Extended Performance Satisfaction Index* (EPSI) (more details at www.epsi-rating.com).

At the initiative of the European Commission and pan-European organizations for quality (*European Foundation for Quality Management* – EFQM and *European Organisation for Quality* - EOQ) it was initially implemented and examined during 1997 (Veljković and Marinković: 2010).

Customer satisfaction and perceived quality are measured using this index in a large number of countries, and, during 2009, over 900,000 telephone interviews were performed, whereby they referred to both final customers and business customers. Among countries where customer satisfaction index was measured using EPSI index, the countries that may be singled out are all Scandinavian countries (Norway, Denmark, Finland, Sweden, Iceland), Baltic countries (Latvia, Lithuania, Estonia), as well as several other European countries (such as Russia, Czech Republic, Portugal, Greece, Ireland, Ukraine, etc.) (<http://www.epsi-baltics.org>).

The interesting example is the one of Norway, where, by using analysis of deficiencies in Sweden, American and European model, members of the CFI group (*Claes Fornell International Group*) proposed a series of modifications in order to improve customer satisfaction measuring system in that country. Their proposals have been incorporated into the new *Norwegian Customer Satisfaction Barometer* (NCSB) (Johnson, Gustafsson, Andreassen, Lervik and Cha, 2001).

Customer satisfaction models imply identification of three groups of variables. These are (Maričić, 2011): causes of satisfaction (e.g. value, quality, expectations), satisfaction (resulting variable of the model) and consequences of satisfaction (complaints, loyalty, etc). These are so called latent variables of the model, whereby it is recommended that each of these is measured using a larger number of statements. Multidimensional approach implies more precise measuring of specific structures. Generally, most variables are measured by 2-6 statements that are included in the questionnaire. Exception to this rule can occur in case of quality of a product/service. Sometimes the

## MEASURING CUSTOMER SATISFACTION

quality is examined by using a larger number of parameters, which is generally the case if SERVQUAL quality measuring model for service sector is applied. Subjects show their positions most frequently in the ten-degree numerical scale. However, for performing these measurements, the five-degree or seven-degree scales are being applied. Index value of each latent variable of the model moves between 0-100. Index of specific latent variable is shown as the sum of average marks that test subjects gave to parameters of measuring, weighted by relevance of stated parameters for customer's selection of product/service (Hill and Alexander, 2006).

Table 1 shows a comparative analysis of the most famous and most accepted models for measuring satisfaction at the national level: *Swedish Customer Satisfaction Barometer* – SCSB, *American Customer Satisfaction Index* – ACSI, *European Customer Satisfaction Index* – ECSI (as predecessor and basis for EPSI model) and *Norwegian Customer Satisfaction Barometer* – NCSB.

**Table 1: Comparative review of selected models for measuring customer satisfaction at the national level**

	Year of occurrence	Founder	Number of industries and companies	Latent variables	Limitations
SCSB	1989	University of Michigan (and CFI group)	32 industries and about 130 companies (in Sweden)	perceived performances, expectations, satisfaction, complaints, loyalty	Annual reporting – lack of more frequent data presentation
DK	1992	GMA & German Post AG	50 industries (in Germany)	satisfaction, separate measuring procedure for other variables	One question for measuring satisfaction, lack of causal approach
ACSI	1994	CFI Group, University of Michigan & ASQ	43 industries and over 200 companies (in the USA)	perceived performances, expectations, perceived quality, satisfaction, complaints, loyalty	Researches did not confirm significant connection between expectations and value, value and quality, expectations and satisfaction in certain industries
ECSI	(1997) 1999	EOQ, EFQM & IFCF	11 countries, minimum 3 sectors per country (in pilot research)	image, customer expectations, perceived quality of product, perceived quality of service, perceived value, satisfaction and loyalty	Small number of sectors included in pilot-research in certain national economies
NCSB	2001	Johnson, et al.	5 service industries (in Norway)	SERVQUAL quality dimensions, price, resolution of complaints, satisfaction, affective attachment, calculative attachment, image, loyalty	Large number of latent variables, not performed application of model in manufacturing sector

Source: Veljković S., Marinković V., (2010) *Modeli za merenje satisfakcije na nacionalnom nivou (Models for Measuring Satisfaction at National Level)*, magazine "EKONOMSKE TEME" No. 3

Methodologically speaking, all national models, with the exception of German barometer, are conceived on the principle of testing causal relation between latent variables. Only in DK model satisfaction is examined separately, by using only one claim, which is a serious limitation and main

weakness of the German model comparing to other models. Apart from this, DK model measures satisfaction using five-degree numerical *scale* (Johnson, Herrmann and Gustafsson, 2002). It is important to emphasize that in the German barometer results related to quality and loyalty in certain industries are shown in the form of frequencies, with the aim to determine percentage of completely satisfied, satisfied and dissatisfied customers (Grigoroudis and Siskos, 2004). Presented claims clearly differentiate DK from other national models. Swedish and American models have presented a foundation for structuring other national indices. Numerous researchers are mainly relying on the *American Customer Satisfaction Index* in their studies. We can state that almost all later formulated barometers present adaptations of Swedish and American models. However, despite all praises and the fact that it represented a role model for conceiving national models in other countries, ACSI demonstrates certain weaknesses. Empirical researches of the CFI group point out that there is weak connection between expectations and value. In studies he performed during 1996, C. Fornell emphasized that customer expectations relate prior to quality than value. That is why a certain obscurity in the expectations-value relation appears. C. Fornell suggests that that the weak impact of expectations to value in services sector and manufacturing of permanent customer goods is noticeable. Customer experiences that they acquire through cooperation with service providers affect their expectations to become more rational, more passive or even stop to exist as the time passes (Johnson, Gustafsson, Andreassen, Lervik and Cha, 2001).

Unlike the American, the European (ECSI) and Norwegian models provide the possibility of more detailed examination of customer loyalty. Value of ECSI model is in the fact that it provides comparable results in a large number of European countries. Apart from this, the model emphasizes necessity of separate review of product quality and service quality. Despite generally good adjustment to measuring satisfaction in service industries, the Norwegian model is much too complex in some of its elements (presence of affective and calculative attachment). NCSB analyzes quality of services (through SERVQUAL dimensions) in detail and introduces variable "resolution of complaints" as a satisfaction starter, which is new compared to previous models. However, it would be beneficial to have this model be examined in manufacturing sector as well. There is a danger that NCSM is too adjusted to needs of service organizations, which reduces the ability of the model to provide relevant data at the level of entire national economy (Veljković, Marinković, 2010).

As far as the application in the Republic of Serbia is concerned, it should be pointed out that in 2005 *Faktor plus*, a marketing research agency from Belgrade, performed satisfaction research in the market of Serbia using ACSI license (Maričić, 2011). Apart from this, the Ministry of Trade and Services of the Republic of Serbia had been planning to develop *Customer Satisfaction Index in Serbia* during 2009 and 2010. A work group of experts from the ministry, the Faculty of Economics of the University of Belgrade and the Statistical Office of the Republic of Serbia was formed, with the task to analyze existing global models, to note specific traits of needs and the market of the Republic of Serbia itself, and to perform trial research and design a model. Overall goals of continual monitoring of customer satisfaction in the territory of Serbia, set by the ministry, were connected to measuring of product and service quality as seen by customers on a continual basis; clearer presentation of condition in the economy of the Republic of Serbia; comparison with the condition in other countries; raising awareness of customers and managers, etc (Veljković, 2009).

Proposal of methodology was made to enable calculation, comparison and continual monitoring of total customer satisfaction index, but also to perform, in future, integral monitoring and connecting of this index to satisfaction index of participants in marketing channels at macro level in the Republic of Serbia (where the relationship between manufacturers, retailers and wholesalers is viewed). Apart from this, care was taken of results comparability, and of aspirations of Serbia towards the European Union, so the model mostly relied precisely on European model for customer satisfaction measurement. Unfortunately, due to budgetary restrictions, and changes that occurred in the ministry itself and its organization, the *Customer Satisfaction Index in Serbia* was not implemented in practice.

### Measuring customer satisfaction at micro level

Improvement of customer satisfaction in companies implies application of adequate measuring system that needs to show to which extent is marketing mix program synchronized with the needs and wishes of customers. There are two basic approaches to satisfaction measurement at micro level:

- Qualitative or explorative research, which in principle has subjective character and experimental trait; and
- Quantitative research, which is more objective and can serve for more precise reasoning.

Both approaches are equally significant and applied in measuring customer satisfaction in companies. Each of them has advantages and limitations. Selection of approach is conditioned with objectives of measuring customer satisfaction and specific needs of research bearer.

Qualitative and quantitative research of customer satisfaction is being performed using a number of methods and techniques. Internal methods are seemingly acceptable for a company, but have limited range due to design of sampling and other research aspects. Specialized organizations apply the so called external methods and techniques of measuring customer satisfaction. Companies choose external methods and techniques in situations when making important decisions or correcting their business policy according to changes and requirements of the market (Maričić, 2011).

The most frequent methods of measuring customer satisfaction used in qualitative approach are: in depth interview and focus groups. Apart from these two basic methods, other measuring methods and techniques have been developed with thorough elements of abovementioned methods at its basis. The basic advantage in applying qualitative approach for measuring customer satisfaction is that, based on it, experiences of customers they had when using products or services can be determined (Lesley and Lamping, 2000). Qualitative research enables viewing both positive and negative experiences and determining basic factors that had an impact on them. This is a significant advantage having in mind the fact that delivering value is one of primary objectives of marketing strategy in modern conditions of operation (Maričić and Đorđević, 2012). Apart from everything mentioned, the important advantage of qualitative approach is also the fact that the examiner or moderator, who is professionally trained, is in immediate contact with customers in research procedure and can motivate them and direct discussion in order to get the necessary information to determine the degree of customer satisfaction and consider possibilities to increase it (Lesley and Lamping, 2000).

The deficiency of qualitative approach in research of customer satisfaction is that evaluations greatly depend on the ability of examiner, which imposes a high level of subjectivity. Likewise, due to rationalization of expenses, qualitative approach is being applied to a smaller number of subjects, so conclusions can be to a significant extent primarily influenced by a demographic, socio-economic or psychological factor.

Quantitative approach implies examination of a larger number of subjects (customers) using questionnaire. Quantitative approach avoids the subjectivity of examiner and eliminates impacts of demographic, socio-economic or psychological factors. Quantitative approach basically provides more reliable information for marketing analysis.

Basic deficiency of quantitative approach in research of customer satisfaction is that the reliability of information mostly depends on the questionnaire used for performing examination. There is no universal questionnaire for measuring customer satisfaction at micro level, which a priori means the necessity to create a separate questionnaire for each research, which increases the possibility of error in estimation of satisfaction level (Lesley and Lamping, 2000). The questionnaire frequently reflects the perspective of the person creating the questionnaire to customer satisfaction. Also, it is more difficult to motivate customers to give as complete and precise answers as possible in quantitative approach. Results of quantitative research cannot measure customer experience in use of

the product or service consumed, which presents a significant limiting factor (Lesley and Lamping, 2000).

Review of available literature points to four basic methods for measuring customer satisfaction at micro level, which rely on quantitative and qualitative approaches or their combination to get as precise result as possible.

The first method is *measuring ratings of all attributes of products and services using structured questionnaire*. This method of measuring customer satisfaction implies determining all aspects (attributes) of products and services and having customer determine the satisfaction rating for each of them. For example, in case of a restaurant, attribute of a product or service can be: environment, courtesy of staff, speed of serving, quality of food, etc. Application of this method for measuring satisfaction would mean having customers determine the rating of each service attribute, which in case of quantitative approach would be evaluation on a scale (e.g. 1. bad; 2. medium; 3. good; 4. very good; and 5. excellent). In case of qualitative approach, by applying a certain method (e.g. focus group) each restaurant offer would be specially evaluated.

The second measuring method is *determining specific deviations of each attribute of a product or service from customer expectations*. This method of measuring presents a kind of diagnosis for each attribute of a product or service with respect to considering ways it affects customer satisfaction and how that satisfaction can be improved. Measuring implies that customers state what is it that was important to them for each attribute of a product or service, i.e. based on what they evaluate that attribute positively or negatively. Measuring enables opposite deduction as well; what is it that was bad in each separate attribute of the product or service. Result of this measuring method is a kind of establishment which elements of each attribute of a product or service have positive impact on customer satisfaction, and which have negative impact. Corrective actions that need to provide improvement of customer satisfaction can be formulated based on the measuring.

The third method of measuring is *determining customer priorities*. This method of measuring satisfaction is the most immediately connected to the concept of value design for customers. Measuring implies determining which elements of a product are the most significant for customers, which have medium significance, and which are almost insignificant. Different product elements have different impact on increase of benefit for customers. Elements that customers see as the most significant have the largest impact to customer satisfaction (Maričić and Đorđević, 2012). Due to the fact that improvement of each element of the product influences the increase of costs and increase of sales price, customer satisfaction management implies focusing on elements with greatest significance. This measuring method provides the possibility to optimize function of value for customers to have maximum customer satisfaction for invested money and other non-cash sacrifice.

One of the latest methodologies used for determining customer priorities is QFD (*Quality Function Deployment*) methodology. QFD presents a useful tool in the product and service design process and the process of connecting quality with designed values. QFD is a process of converting customer preferences into a design of manufacturing process and creation of standards to produce a product/service with quality that offers maximum value for customers. QFD methodology can be presented as a systematic way to gather information on needs, expectations and preferences of customers, and, based on these data, to design products and/or services with such quality that provides maximum value to customers. Basic goal of QFD methodology is to design and deliver customers products of such quality that is in accordance with their expectations and preferences. The methodology provides the possibility to design products with superior performances (from customer's perspective), which is definitely imposed as imperative of modern business management.

The fourth measuring method is *determining satisfaction for different customers*. Measuring starts from the fact that customer satisfaction is a subjective category and that different demographic, socio-economic and psychological characteristics of customers have impact on its value. Measuring

## MEASURING CUSTOMER SATISFACTION

---

implies considering satisfaction for different segments of customers divided on the basis of some of their characteristics – sex, age, education, monthly income, etc. It is possible to apply one of three abovementioned methods, for each segment separately. Measuring enables considering satisfaction in different customer segments and focusing efforts for improvement of satisfaction to targeted market niches. The approach is very useful in modern conditions of operation when companies are more and more compelled to focus their marketing strategies towards specific market segments of customers.

### Conclusion

It can be definitely presumed that all attempts to measure customer satisfaction have much improved the business practice and quality of people's lives. Company performances have been improved, quite significantly in developed countries; foreign managers increasingly use customer satisfaction indices as one of important indicators on movement of company's future profit. However, among offered theoretical solutions and business requirements, there are still large differences that could be overcome by greater application of marketing in operation. The economy's development level and awareness on what one can get with specific attempts and actions of measuring customer satisfaction are very diverse and questionable. The Republic of Serbia has recognized the need to measure customer satisfaction, but, as usually, lacks realization. It seems that everything requires time (which is not an issue), but selfishness must be avoided in pursuing interests and ways leading to so much desired overall well-being. Yes, it goes without saying, this needs to be left to marketing experts.

### References

- Aaker, D. (2008). *Strategic Marketing Management*, John Wiley & Sons Inc. New Jersey.
- Blattberg R., Getz G., Thomson J. (2001). *Customer Equity: Building and Managing Relationships as Valuable Assets*, Harvard Business School Press, Massachusetts.
- Blyth J. (2007). *Consumer Behaviour*, Thomson, London.
- Bruhn, M., Grund M. (2000). Theory, developmente and implementation of national customer satisfaction indices: the Swiss Index of Customer Satisfaction [SWICS], *Total Quality Management*, Vol. 11, No. 7, pp. 1017-1028.
- Cassel, C., Eklof, J.(2001). Modelling customer satisfaction and loyalty on aggregate levels: Experience from the ECSI pilot study", *Total Quality Management*, Vol. 12, No. 7&8, pp. 834- 841
- De Bonis N., Balinski E., Allen P. (2002). *Value-Based Marketing for Bottom-Line Success*, American Marketing Asociation, McGrow Hill, New York.
- EPSI Rating – International Benchmark trends for Customer Satisfaction and Consumer Sentiment monitoring Customer Satisfaction – 2009, <http://www.epsi-baltics.org/index.php?option=content&task=view&id=43> (accessed 10.07.2010).
- Fornell, C. (1992). A National Customer Satisfaction Barometer:The Swedish Experience, *Journal of Marketing*, Vol. 56 (January ), pp. 6-21.
- Grigoroudis, E., Siskos, Y. (2004). A survey of customer satisfaction barometers: Some results from the transportation-communications sector, *European Journal of Operational Research* 152, pp. 334-353.
- Gronoros C. (2007). *Service Management and Marketing: Customer Management in Service Competition*, 3th Edition, John Wiley & Sons, New York.
- Hill, N., Alexander, J. (2006). *Handbook of customer satisfaction and loyalty measurement*, Gower Publishing Limited, Hampshire.



- Johnson, M., Gustafsson, A., Andreassen, T., Lervik, L., Cha, J. (2001). The evolution and future of national customer satisfaction index models, *Journal of Economic Psychology*, Vol. 22, 2001, pp. 217-245.
- Johnson, M., Herrmann, A., Gustafsson, A. (2002). Comparing customer satisfaction across industries and countries, *Journal of Economic Psychology*, Vol. 23, pp. 749-769,
- Johanson W., Weinsten A. (2008). Superior Customer Value In The New Economy, CRC Press, New York.
- Kotler P., Keller K. (2011). Marketing Management, 14<sup>th</sup> edition, Pearson International Edition, New Jersey.
- Lesley A., Lamping D. (2000). Different ways to measure satisfaction, *British Journal of Midwifery*, Vol. 8, No. 7, 2000. pp. 422 – 428.
- Madu C. (2007). Qulaity Function Deployment (QFD) In a Minute, 2<sup>nd</sup> Edition, Chi Publishers, New York.
- Maričić B., Đorđević A. (2012). Kreiranje i isporučivanje vrednosti potrošačima, CID Ekonomski fakultet, Beograd.
- Maričić B. (2011). Ponašanje potrošača, IX izdanje, CID Ekonomski fakultet, Beograd.
- Marinković V. (2012). Marketinški aspekti satisfakcije i lojalnosti, Ekonomski fakultet u Kragujevcu.
- Milisavljević M. (2010). Strategijski marketing, CID, Ekonomski fakultet Beograd.
- Oliver W. (2002). Consumer Value: A Framework for Analysis and Research (Holbrook M.), Taylor & Francis, New York.
- Quester P., Neal C., Pettigrew S. (2007). Consumer Behaviour: Implications for Marketing Strategy, 5<sup>th</sup> Edition, McGraw-Hill Education, New York.
- Terniniko J. (2000). Step-By-Step QFD: Customer Driven Product Disign, 2nd Edition, CRC Press, Florida.
- Vavra G. T. (2002). Customer Satisfaction Measurement: A Step-by-Step Guide for ISO 9001:2000, 1<sup>st</sup> edition, Certification American Society for Quality, Wisconsin.
- Veljković S., Marinković V. (2010). Modeli za merenje satisfakcije na nacionalnom nivou (Models for Measuring Satisfaction at National Level), *Ekonomske teme* No. 3, pp. 383-402.
- Veljković S. (2009). Marketing usluga, CID Ekonomski fakultet, Beograd.
- [www.epsi-rating.com](http://www.epsi-rating.com)
- [www.theacsi.org](http://www.theacsi.org)
- Zeithamal V., Bitner M., Gremler D. (2006). Services Marketing: Intergrating Customer Focus Across the Firm, 4<sup>th</sup> Edition McGraw-Hill, New York.
- Zhang Q., Vonderembse M., Jeen-Su Lim. (2006). Spanning Flexibility: Sustrly Chain Information Dissemination Drives Strategy Development And Customer Satisfaction, *Supply Chain Management: An International Journal*, Vol. 11, No.5, pp. 390–399.



# MONITORING HEALTH RESORT CUSTOMERS' SATISFACTION AND EXPECTATIONS ON THE EXAMPLE OF THE CUSTOMERS OF THE INNOVATIVE CLUSTER OF HEALTH AND TOURISM "HEALTH RESORTS - PEARLS OF EASTERN POLAND"

Jacek Rodzinka<sup>1</sup>

Robert Gora<sup>2</sup>

**Abstract:** *In today's competitive market, companies should make every effort to ensure that customers are fully satisfied with the quality of goods and services offered to them. A higher level of satisfaction provides a chance to change a casual customer to a loyal customer. Loyal customers often buy the products, spend more money on them and recommend the company (or product) to others. From this point of view, loyal customers are the most valuable asset of a company. Two of the key elements shaping customer loyalty is studying the expectations and level of customer satisfaction and responding to their comments. The paper presents the results of research conducted in 2011 among 965 customers staying in 11 health resort entities. The entities were located in five municipalities incorporated into the Innovative Cluster of Health and Tourism "Health Resorts - Pearls of Eastern Poland".*

**Keywords:** *customer satisfaction, customer expectations, health resorts*

## Health Resorts in Poland – Legal Conditions

A health resort is an area where sanatorium treatment is conducted, and which has been marked off as a separate area to use and protect its natural therapeutic resources. Such an area must gain the status of a health resort. The communes which have gained such a status – in full or in part – are called health resort communes (Mika, Jackowska, 2008).

The status of a health resort or of an area of health resort protection is granted to a given area with a resolution of the Council of Ministers. The register of health resorts and areas of health resort protection is kept by the Minister of Health. A commune applies for such status by presenting a health resort report which allows to decide whether it meets the requirements listed in the health resort act.

The status of a health resort is not granted for an indefinite time. At least once every 10 years, the commune must confirm to the Minister of Health that it still meets the requirements to use the status. To do that, another health resort report is prepared and presented to the Minister to confirm that the requirements listed in the health resort act are met.

In Poland there are currently 44 statutory health resorts. Moreover, about 70 more localities may be indicated in our country that have potential health resort values and a chance to become health resorts in the near future.

According to the act on sanatorium treatment, health resorts and areas of health resort protection and on health resort communes (Dz. U. of 2005), borders of an area which has been granted the status of a health resort or of an area of health resort protection correspond with the administrative borders of

---

<sup>1</sup> Faculty of Economics, University of Information Technology and Management, Rzeszow

<sup>2</sup> Faculty of Economics, University of Information Technology and Management, Rzeszow, rgora@wsiz.rzeszow.pl

## **MONITORING HEALTH RESORT CUSTOMERS' SATISFACTION AND EXPECTATIONS ON THE EXAMPLE OF THE CUSTOMERS OF THE INNOVATIVE CLUSTER OF HEALTH AND TOURISM "HEALTH RESORTS - PEARLS OF EASTERN POLAND"**

---

the given commune, town or communal auxiliary units. A health resort status may be granted to an area which meets all of the below requirements:

1. has deposits of natural therapeutic resources of confirmed therapeutic properties as specified in the act;
2. has a climate of confirmed therapeutic properties;
3. has within it sanatorium treatment facilities and equipment prepared to offer sanatorium treatment;
4. meets environment-related requirements specified in the provisions on environmental protection;
5. has technical infrastructure as concerns water and sewage management, energy management, public transport, as well as waste management.

A status of an area of health resort protection may be granted to an area which meets all of the requirements given in points 1, 2, 4 and 5 above.

A commune applying for a status of a health resort or of an area of health resort protection must obtain confirmation of the curative nature of the natural therapeutic resources and of the therapeutic properties of the climate. These are confirmed with a certificate of the curative properties of the natural therapeutic resources and of the therapeutic effect of the climate.

The status of a health resort or of an area of health resort protection provides legal and organisational foundations to conduct sanatorium treatment and recreational and tourism activity in the given area.

Health resorts in Poland may be classified according to various criteria. The ones most commonly used are:

### 1. Geographical location:

- lowland health resorts, located below 200 m above sea level - Augustów, Krasnobród, Busko Zdrój, Nałęczów, Ciechocinek, Połczyn Zdrój, Goczałkowice Zdrój, Przerzeczyn Zdrój, Gołdap, Solec Zdrój, Horyniec Zdrój, Supraśl, Inowrocław, Swoszowice, Konstancin, Swoszowice, Wieniec Zdrój,
- seaside health resorts, located no further than 3 km from the seashore - Kamień Pomorski, Świnoujście, Kołobrzeg, Ustka, Sopot, Dąbki,
- submontane health resorts, located between 200 and 400 m above sea level - Cieplice Zdrój, Piwniczna Zdrój, Czerniawa Zdrój, Polanica Zdrój, Długopole Zdrój, Polańczyk, Duszniki Zdrój, Rymanów Zdrój, Iwonicz Zdrój, Szczawno Zdrój, Kudowa Zdrój, Ustroń, Muszyna Zdrój, Wapienne,
- mountain health resorts, located between 400 and 800 m above sea level - Jedlina Zdrój, Szczawnica, Krynica Zdrój, Świeradów Zdrój, Łądek Zdrój, Wysowa Zdrój, Rabka Zdrój, Żegiestów Zdrój,

### 2. Natural therapeutic resources in the area:

- spas (in the basic sense of the word) - health resorts with therapeutic waters,
- peat health resorts – based on peat treatment,
- mixed health resorts – with therapeutic waters and peat.

The status of a health resort gives the commune a possibility to change its name and to obtain additional revenue on that account. The name of the village or town within whose administrative

borders the health resort area is located is changed by adding to it. That added element is either the word "zdrój" [spa], if the sanatorium treatment uses mainly therapeutic waters, or "cieplice" or "uzdrowisko termalne" [thermal spa or health resort], if the sanatorium treatment bases on thermal waters. Beside the change in name, a health resort commune is entitled to charge a health resort fee, and also receives a subsidy from the state budget. The amount of the subsidy equals the revenues from the health resort fee collected by the resort in the previous year.

The figure below illustrates the location of statutory health resorts in Poland.

**Figure 1. Map of health resorts in Poland**



Source: <http://gazetakuracjusza.pl/> of 12<sup>th</sup> September 2011

As is clearly visible, Polish health resorts are not spread out evenly. Health resort communes are mainly grouped in the mountains and at the seaside. Polish health resorts are located in the most attractive areas of the country as concerns natural, landscape and climatic conditions.

### **Innovative Cluster Health and Tourism**

The Innovative Cluster Health and Tourism “Health Resorts – Pearls of Eastern Poland” has been established under the Agreement of 5<sup>th</sup> June 2009. The initiative joined entrepreneurs and communal governments from 5 health resort communes from the Podkarpacie and Świętokrzyskie regions, two universities – the University of Information Technology and Management in Rzeszów

## **MONITORING HEALTH RESORT CUSTOMERS' SATISFACTION AND EXPECTATIONS ON THE EXAMPLE OF THE CUSTOMERS OF THE INNOVATIVE CLUSTER OF HEALTH AND TOURISM "HEALTH RESORTS - PEARLS OF EASTERN POLAND"**

---

and the College of Management and Public Administration in Zamość, and two advisory, business-support institutions – the Association of Entrepreneurship Promotion in Rzeszów and the Business Support Centre Ltd. in Rzeszów.

The Cluster was created in order to use innovations and undertake joint ventures in business processes. “The founders decided that creating a cooperation network would allow to attain synergy in effect of combining and using the potential of people, enterprises, universities, research units, business environment institutions and state and local governments to transfer and diffuse knowledge as well as innovation among the cooperating entities

The task of the Cluster was to create a platform of cooperation between its participants, in order to execute joint projects financed with the participants’ means, European funds and other national and international funds, with particular allocation to: scientific research, joint investment projects, activities related to modern technology development, as well as to promoting the Cluster, its products and services. The Cluster is of a service-oriented nature – it aims to develop therapy services and health resort tourism in relation with eco-tourism, active and cultural tourism. Also, the Cluster aims at popularising a positive image of Eastern Poland’s health resorts, exchanging knowledge, popularising the best practices of cluster cooperation and promoting the idea of clustering.

The Innovative Cluster Health and Tourism “Health Resorts – Pearls of Eastern Poland” has been established as a result of a project within the Operational Programme: Development of Eastern Poland 2007–2013, Priority I: Modern economy, Measure 1.4: Promotion and cooperation, Component 2: Cooperation, Field 2.2: Establishment and development of clusters (contract for project financing of 30.12.2009 No. PO PW 01.04.03-00-009/09-00). The project aims to develop the cooperative (cluster) relationship among its participants active in the branches of health tourism and health resort tourism, as well as to include other entities interested in cooperation.

### **Treatment offer of sanatorium entities**

In Poland, a patient receives a referral to sanatorium treatment from a doctor, who considers the indications and contraindications for such treatment. In the case of referrals from the National Health Fund (NFZ) patients may benefit from sanatorium treatment once a year. In the case of referrals from the Social Insurance Company (ZUS) there is no such limitation, since it is more profitable to that institution – as the insurer – to send a person who is unable to work to a sanatorium than to pay them social allowance. The condition is that ZUS doctors expect the sanatorium treatment to bring the effect of allowing the rehabilitated person to return to work.

A health resort sanatorium must ensure to the patients all-day residential health care services, service of doctors and nurses, natural therapy treatment using natural therapeutic resources and sanatorium treatment equipment as stated in the treatment programme, prophylactic services and health education.

Sanatorium facilities must provide at least three treatments daily, aimed at treating the given illness through stimulation therapy using natural therapeutic resources, and additional physiotherapeutic treatments.

Classical forms of sanatorium treatment include:

- treatments using therapeutic waters,
- treatments using peloids,
- treatments using therapeutic gases,
- hydrotherapeutic treatments,
- kinesiotherapeutic treatments,

- physiotherapeutic treatments,
- massages.

An important element of the therapy is a diet conforming to the therapy profile, as well as health education and promotion.

An analysis of therapy profiles of the health resorts included in the Innovative Cluster Health and Tourism shows that they are able to provide a wide range of treatments using natural therapeutic resources. The product offer depends on the range of illnesses treated in the particular resorts. Most entities specialise in treating selected types of illnesses, and long years of traditions in that respect make people associate them with treating those. It is an important element that could be used to build the health resort's brand.

Graph 1. Product offer of Cluster health resorts

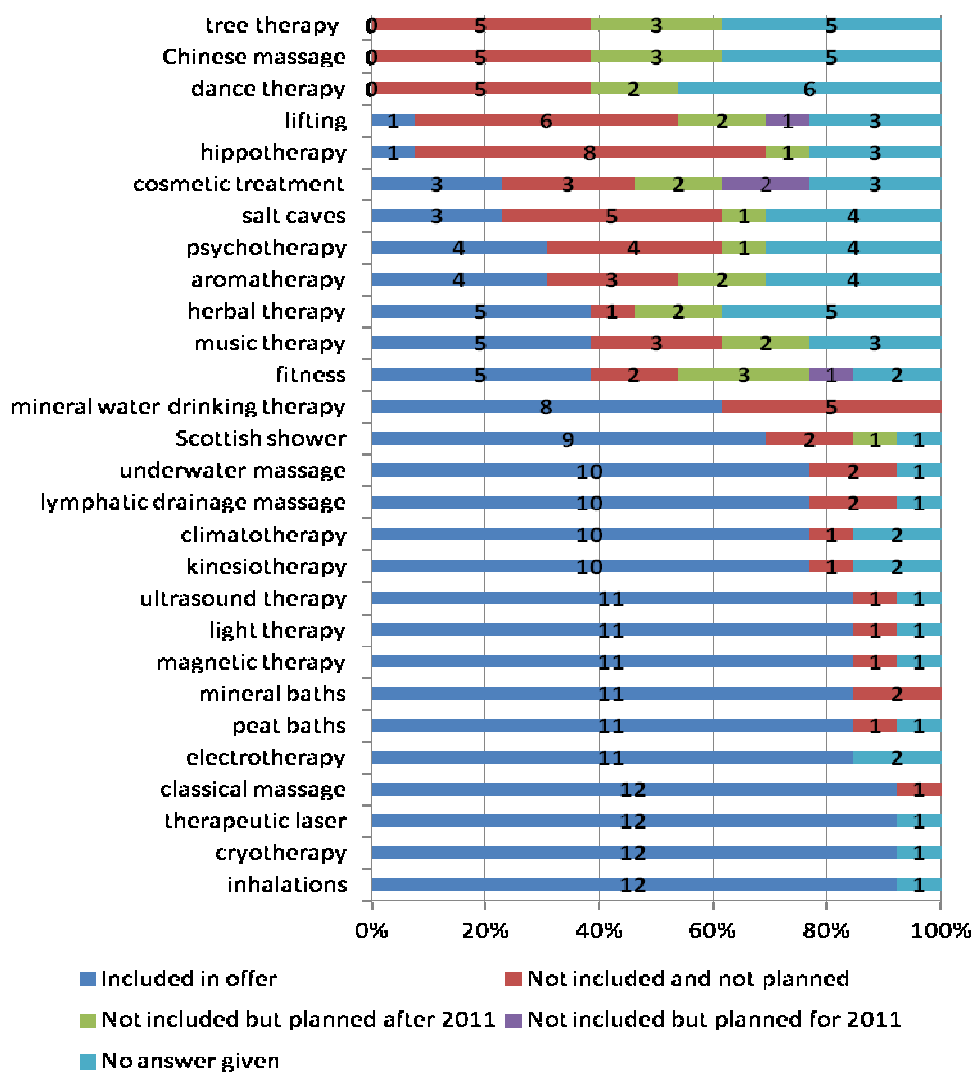

Source: Own study based on the survey

## **MONITORING HEALTH RESORT CUSTOMERS' SATISFACTION AND EXPECTATIONS ON THE EXAMPLE OF THE CUSTOMERS OF THE INNOVATIVE CLUSTER OF HEALTH AND TOURISM "HEALTH RESORTS - PEARLS OF EASTERN POLAND"**

---

In the recent years, entities providing sanatorium services have had to face the need to adjust their offers to the needs of two customer segments. The first group are sanatorium patients, referred there and financed by the National Health Fund, the Social Insurance Company or the Agricultural Social Insurance Fund (KRUS). The other group are commercial customers, who bring notable financial benefits to the resort facilities. It is thus necessary to adjust the offer of products to customer expectations, particularly as concerns the latter groups of service recipients. The management is aware of the need to make changes and, as far as possible, they start investing in renovating the hotel and catering infrastructure, to improve service standards. Also the scope of services and the profile of the programmes offered are changing.

As shown by research conducted in the 1<sup>st</sup> quarter of 2011 on a sample of 13 entities providing sanatorium services, all the entities offer inhalation therapy, cryotherapy, therapeutic laser and classical massage. The offers of most of them include electrotherapy, peat and mineral baths, magnetic therapy, light therapy and sound therapy. Relatively many entities offer kinesiotherapeutic and climatotherapeutic treatment, lymphatic drainage and underwater massages, and Scottish shower. Climatotherapy includes: helio- and aerotherapy, outdoor physical exercises, and natural inhalations. In eight out of the thirteen entities the customers have direct access to curative drinking waters.

Much fewer entities claim to offer treatments from outside the classical range of sanatorium treatment. In five entities the customers may have fitness classes, music therapy, herbal therapy. Aromatherapy and psychotherapy are offered by four entities each. Only a third of the respondents offer cosmetic treatment.

Beside the products listed in the questionnaire, individual entities indicated a range of services related to curative baths (e.g. brine, whirlpool, contrast, carbonic acid, sulphide baths) and relaxation treatments, e.g. Thai massage.

Analysis of the declared changes to the offer both for 2011 and later shows that they concern introducing fitness exercises, cosmetic treatment, music therapy, herbal therapy, aromatherapy, and certain novelties: Chinese massage, tree therapy and dance therapy. The offer should be constructed using the commune's natural environment and considering the current trends and needs of the customers. Health resorts seek ways of supplementing the classical sanatorium offer with relaxation and regenerative treatments. The service package must be flexible enough to attract also commercial customers to the resort. Those customers have bigger financial possibilities, but also higher expectations as concerns customer service, and less time to devote to relaxation. Introducing such services in the offer is an answer to the interest in "wellness" offers. Such services may be put in two groups: those that condition the body and such as relax the spirit and put you in a blissful mood. Body beautification ways include mainly various massages (with and without the use of water), mud and herbal poultices, peeling, gym, fitness, light therapy, cryotherapy, etc. Wellness therapies help to fight problems, both physical and mental. They most commonly include various ways of managing stress, detoxifying and oxygen therapies, slimming therapies and meditations. Massages are one of the most ancient therapies and recently they are returning to the focus of interest. Yet currently, a massage must be enriched with numerous additions. It may be e.g. aromatherapeutic massage, i.e. massage combined with the effects of essential oils. Traditional therapies, e.g. herbal therapy (phytotherapy), which consists in treating a patient using fruits, vegetables and herbs, also enjoy renewed interest.

### **Description of the sample**

The research concerning satisfaction and expectations of the customers of entities providing sanatorium services was conducted in 2011. The examined population consisted of patients using Cluster members' services. CATI (Computer Assisted Telephone Interviews) methodology was



applied, using a standardised questionnaire. An analysis of the occupational status of people partaking in the research shows that most of them – as many as 56% - were retired, 26% of respondents were working, 9% were on a disability allowance, 4% were farmers, 2% ran their own businesses. People who indicated a different status - 2% of respondents – were unemployed, received early pension or a rehabilitation benefit.

Over half of the respondents said the monthly income per person in their family to be from 1000 to 2000 PLN. An income between 500 and 1000 PLN were indicated by 18% of respondents, smaller income – by 5%, and larger than 2000 PLN per capita by 24% of respondents.

57% of respondents stayed in the sanatorium alone, 31% went to the treatment with their families, and 12% went with friends (usually one).

75% of respondents stayed there for longer periods – from 18 to 35 days. People who came to the sanatorium for 10-15 days made up 21% of respondents, and shorter stays (3-8 days) were indicated by only 4% of the patients.

In the examined population, 73% of respondents had their stay in the sanatorium financed from outside. Almost every other person (61%) had a referral from NFZ. 6% of respondents stayed in the sanatorium on referral from ZUS, and just as many from KRUS. As many as 23% were commercial customers. 3% of respondents indicated a different reason for their stay than treatment – including 1% who claimed they were staying there as tourists.

The group which stayed in the sanatorium privately – commercially – included relatively more people aged 60 or more. A tourist stay or a ZUS referral were indicated more often by people under 40. Commercial stay was indicated more often by city dwellers than country dwellers.

38% of respondents were staying in the evaluated health resort for the first time. For the remaining 62% it was at least the second stay (second or third stay were indicated most often – by 14% of respondents).

A repeated stay concerned most frequently elderly people, particularly those over 70 and pensioners. Relatively more often these were people staying in Busko Zdrój and Horyniec Zdrój.

44% of respondents heard about the resort's offer from their doctors. Another 29% had such information from their families, and 18% indicated other sources – most frequently they were referred to the given resort by the institution which organised their stay. 6% of respondents sought information online, 2% had the information from other media (press, radio or television). Only 1% were informed about the resort by a travel agency.

Students, working people and people running a business most often sought information in the Web, and pensioners guided themselves with recommendations from friends and information from travel agencies. Patients staying in Busko Zdrój and Horyniec Zdrój had learned about the entities' offers from friends. Information from the doctor was more often indicated by patients in Iwonicz Zdrój, Rymanów Zdrój and Krasnobród.

42% of respondents could choose the health resort whose rehabilitation services they were to use. The others had no possibility to make such a choice themselves.

A slightly smaller group - 39% of respondents – had a say in choosing the sanatorium facility.

## MONITORING HEALTH RESORT CUSTOMERS' SATISFACTION AND EXPECTATIONS ON THE EXAMPLE OF THE CUSTOMERS OF THE INNOVATIVE CLUSTER OF HEALTH AND TOURISM "HEALTH RESORTS - PEARLS OF EASTERN POLAND"

### Analysis of customer satisfaction with the offer of health resort entities and communes

Many success strategies applied by enterprises put the strongest emphasis on maximum customer satisfaction. Enterprises want then to satisfy all customer needs, or at least most of them (Griffin, 2002).

Customers do not purchase a product, they purchase the benefits related thereto. Satisfaction is when the customer has a sense of his expectations having been met. Most commonly, a customer who is satisfied with a purchase or a service not only remains with the given company, but can even advertise it among friends and family (Johnson, Gustafsson, 2000).

As follows from the conducted research, the respondents are pleased with their stays in the sanatoriums. Chosen elements describing sanatorium facilities were rated on a scale of 1 to 5. In all categories, the dominating rating was 5 – the highest level of satisfaction. The highest ratings were given to the competence and friendly attitude of employees, and to the rehabilitation offer and treatments. High grades were also given to the aesthetic qualities and cleanliness of sanatorium facilities. The lowest grades were given to mineral water pump rooms and to the spa and wellness offer.

**Graph 2. Average customer satisfaction with a stay in a sanatorium entity**

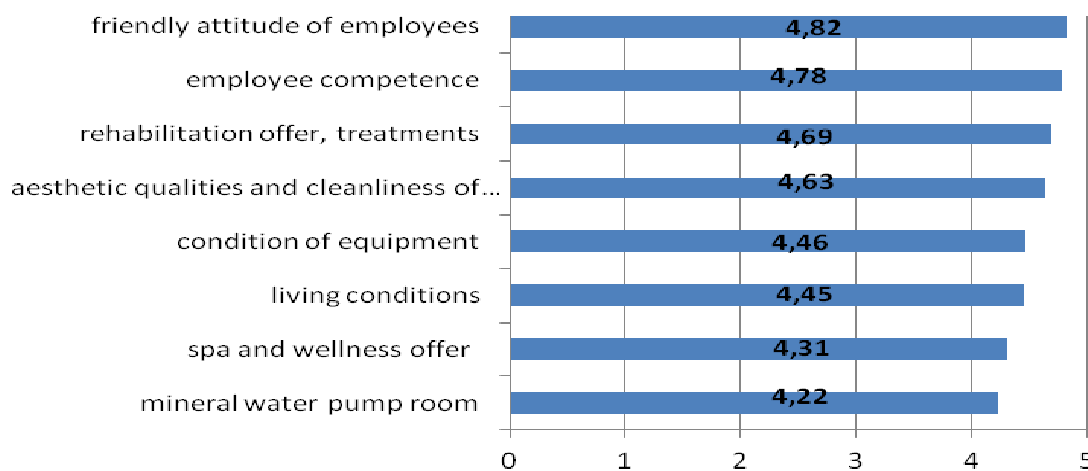

*Source: own study based on research results*

An important element impacting the customer satisfaction level is satisfaction with the proposed offer of rehabilitation treatment. Highly or very highly pleased with that aspect were 96% of respondents.

80% of respondents were pleased or very pleased with the standard of mineral water pump rooms, and about 10% were displeased or very displeased.

The wellness and spa offer pleased 84% of respondents, and displeased 15%. It is a quite large percentage, considering all the evaluated categories. This indicates that sanatorium offers need to have access to such services added.

The examined patients also gave high notes to the condition of the equipment in sanatorium facilities. 88% of respondents were pleased with it.

Accommodation conditions were also assessed well. 89% of respondents were pleased with them, and only 4% claimed to be displeased.

High notes were given to aesthetic qualities and cleanliness in sanatorium facilities. As many as 94% of respondents stated their satisfaction to be high and very high. Only 1% indicated a negative answer.

In the next two categories – friendliness and competence of employees – severe displeasure was indicated only once. 98% of respondents were pleased or definitely pleased with employee competence. A group of nearly the same size (97%) gave the highest notes in the category of friendly attitude of sanatorium workers. It is an undeniable asset of the resorts and significantly impacts the positive evaluations of a stay in a sanatorium.

**Graph 3. Customer satisfaction with a stay in a sanatorium entity**

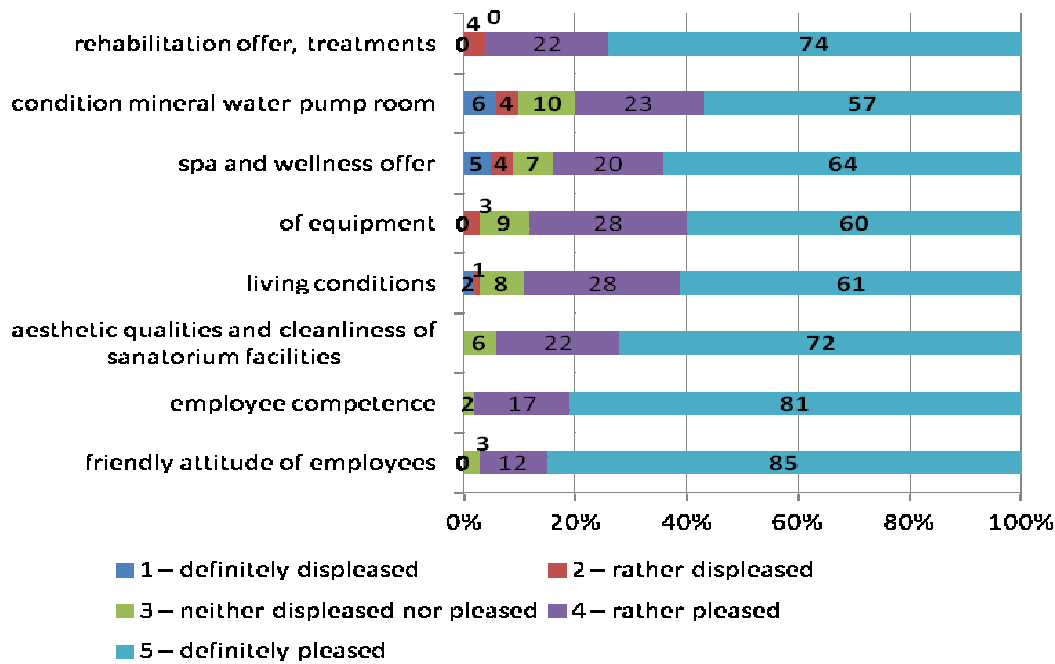

Source: own study based on research results

The highest notes in the analysed categories were given by patients who were over 60 and retired, big city dwellers and country dwellers.

Another part of the research concerned satisfaction with the stay in the health resort town or village. In all categories in which the resorts were evaluated the highest notes prevailed. Particularly high notes were given to the level of security in the resorts, their image and the offer of additional excursions. The lowest notes were given to access to entertainment facilities (cinemas, museums, galleries) and sports and recreation events and infrastructure.

**MONITORING HEALTH RESORT CUSTOMERS' SATISFACTION AND EXPECTATIONS ON THE EXAMPLE OF THE CUSTOMERS OF THE INNOVATIVE CLUSTER OF HEALTH AND TOURISM "HEALTH RESORTS - PEARLS OF EASTERN POLAND"**

**Graph 4. Average customer satisfaction with a stay in a health resort**

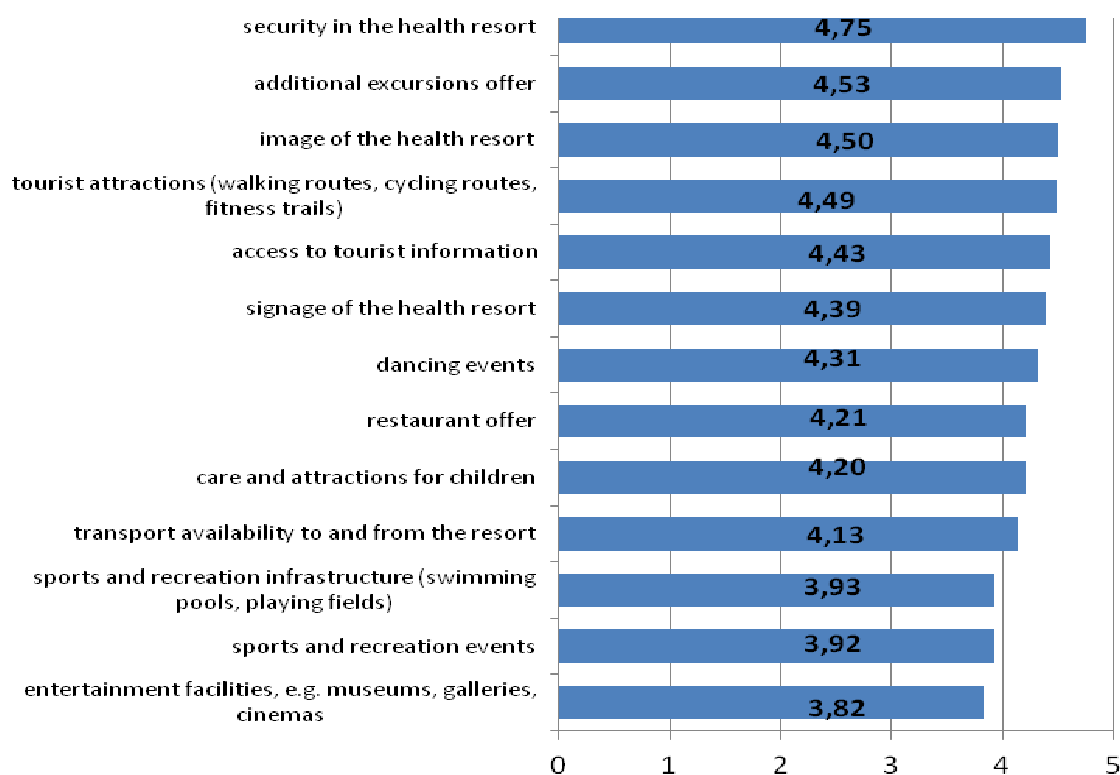

*Source: own study based on research results*

The health resorts are seen as very safe. Such notes were given by 97% of respondents. Only 1% are of a contrary opinion.

Slightly worse notes were given to transport availability to and from the resort. 75% of respondents were definitely pleased or rather pleased. People who indicated displeasure constituted 10% of the group.

In the next category, “access to tourist information”, relatively high satisfaction was indicated. There were 87% definitely pleased and rather pleased respondents. Only 4% of the examined people chose to give a negative note.

The research shows that patients view the health resorts as rather attractive in terms of tourism. 56% of respondents were definitely pleased, and 29% rather pleased. Displeased or rather displeased patients made up 6% in total.

One of the weakest points in the offer of health resorts is the availability of entertainment facilities, such as cinemas, museums or galleries. 39% of the patients were definitely pleased, 24% rather pleased. Quite a large percentage of respondents – 22% – were neither pleased nor displeased. Definitely displeased and rather displeased – 15%.

Better notes were collected by the offer of eating places in the health resorts. 79% of respondents expressed their satisfaction with it, while 6% were not pleased.

High notes were given to the signage of the resorts. 87% of the examined patients were pleased, while only 4% were displeased.

The additional offer of spending leisure time pleased as many as 92% of respondents. That is a very good result, which confirms the excursion offers meeting the patients' expectations. The displeased made up 3%.

84% of respondents were pleased with the organised dancing events. 7% of respondents were displeased with that element of the health resort offer.

Lower notes were given in the two categories of sports and recreation infrastructure, and sports and recreation events. Those elements of the offer pleased 69% and 68% of respondents, respectively. Displeased were 16% and 15%.

**Graph 5. Customer satisfaction with a stay in a health resort**

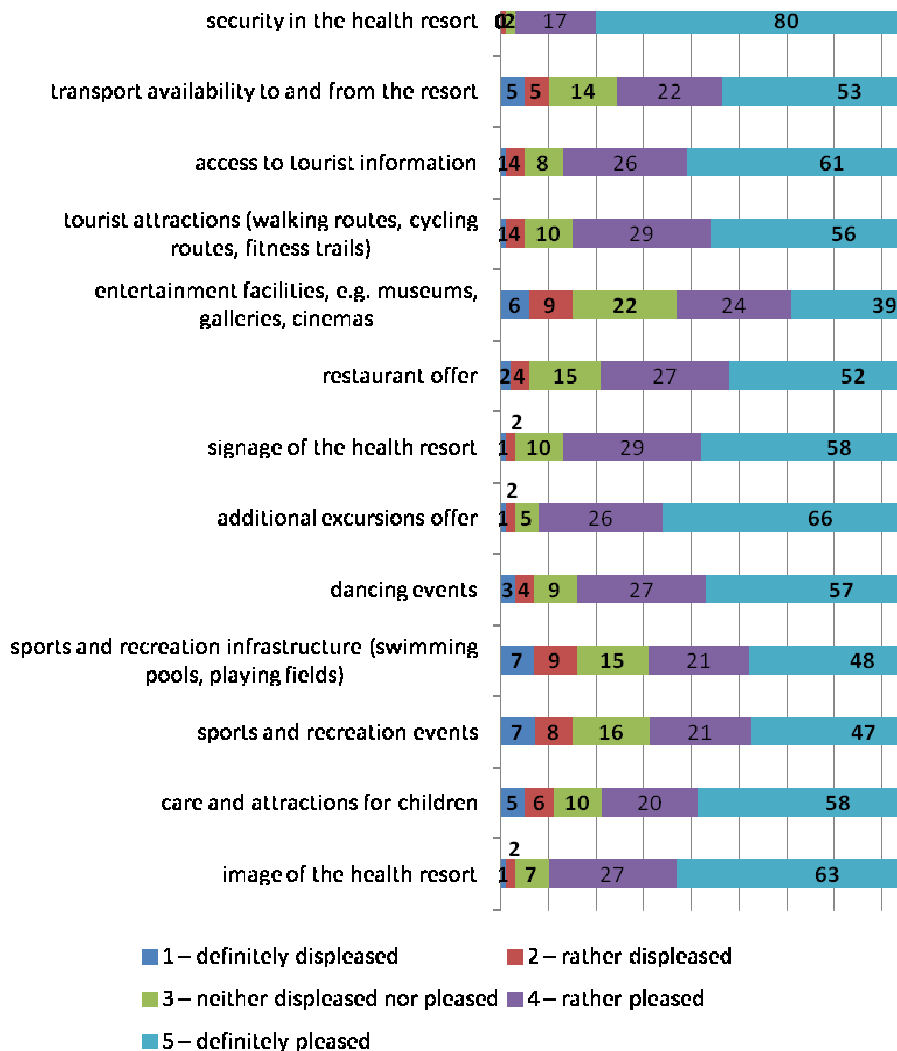

Source: own study based on research results

Organising attractions for children and ensuring care for them was evaluated in a positive manner by 78% of respondents, whereas 11% claimed to be displeased.

## MONITORING HEALTH RESORT CUSTOMERS' SATISFACTION AND EXPECTATIONS ON THE EXAMPLE OF THE CUSTOMERS OF THE INNOVATIVE CLUSTER OF HEALTH AND TOURISM "HEALTH RESORTS - PEARLS OF EASTERN POLAND"

High notes were collected by the image of the health resorts. 90% of respondents were pleased with it, while only 3% expressed displeasure.

The highest notes were given by respondents who were over 60, country dwellers and big city dwellers, people professionally inactive and pensioners, and by patients staying in Busko Zdrój and Rymanów Zdrój.

Analysis of the average results in the particular quarters shows that notes given in the 4<sup>th</sup> quarter were higher than the average for the year. The highest increase in satisfaction concerned the following categories: ensuring care and attractions for children, dancing events, additional offer of excursions, and entertainment facilities. It is also worth noting which categories collected similarly high notes throughout the year. These were: security in the resort, image of the resort, access to tourist information and tourist attractions in the resort.

### Customer expectations

Over a half of respondents (54%) prefer to organise their leisure time by themselves. There are no significant relationships between the expectations and the respondents' age, gender, occupational situation or place of residence.

**Graph 6. Expectations as to leisure time organisation**

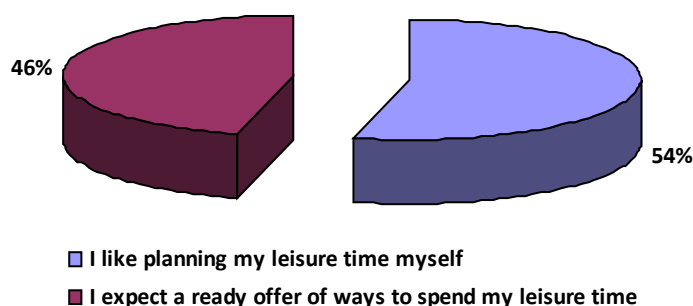

*Source: own study based on research results*

An even larger part of the examined group (61%) like visiting new places. The younger the respondent, the more frequently they claimed to like visiting new places. Respondents staying in Busko Zdrój and Horyniec Zdrój were more willing to revisit the destinations they already knew.

Graph 7. Preferences as to stay



Source: own study based on research

Both the traditional treatment forms and the modern therapies were indicated by approximately half of the respondents. Innovative treatment methods were selected more frequently by a mere 1 percent of the respondents. Traditional treatment forms were indicated more often by people over 70. Professionally active people were more willing to try new treatment methods. Also, women were more inclined than men to try new treatment forms. The fact that patients appreciate and are accustomed to treatments and therapies used for years, and noting at the same time the need to implement new treatment forms should make health resorts consider the possibility of implementing new services based on natural products.

Graph 8. Preferred treatment methods

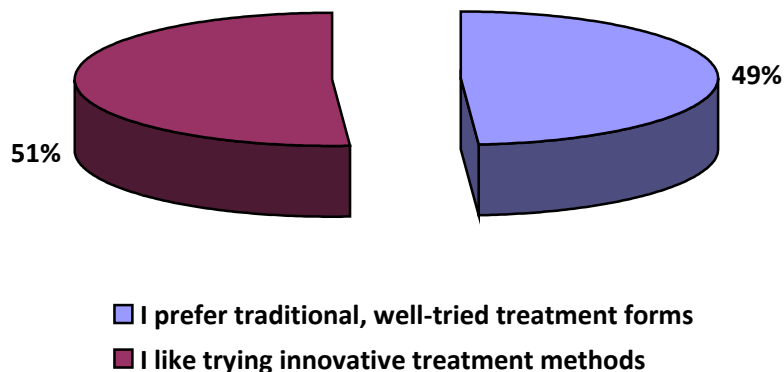

Source: own study based on research results

**MONITORING HEALTH RESORT CUSTOMERS' SATISFACTION AND EXPECTATIONS ON THE EXAMPLE OF THE CUSTOMERS OF THE INNOVATIVE CLUSTER OF HEALTH AND TOURISM "HEALTH RESORTS - PEARLS OF EASTERN POLAND"**

A little over half of the examined group preferred high quality accommodation. Such opinion was given by 52% of the respondents. The answer was indicated more often by residents of cities of over 100 thousand inhabitants, and by professionally active people.

**Graph 9. Preferences as to accommodation standard**



Source: own study based on research results

A vast majority of the respondents opted for spending their leisure time actively. 80% of respondents prefer such leisure activities. That form of spending time was chosen particularly often by people staying in Iwonicz Zdrój, professionally active, aged 41-60, and city dwellers.

**Graph 10. Preferred forms of spending leisure time**

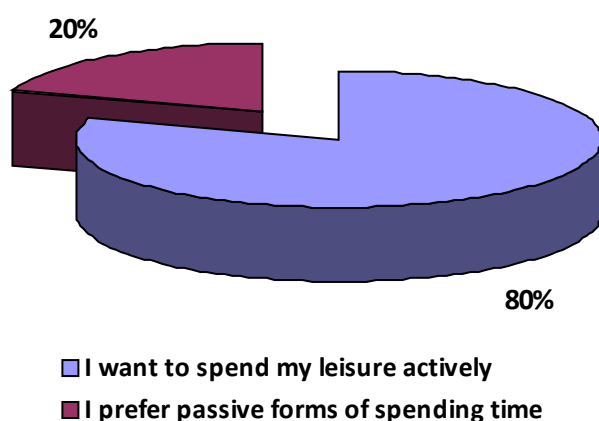

Source: own study based on research results

2/3 of the examined patients were pleased with their stay in the given health resort. They would have gladly come again to the resort they had recently visited. Every fifth person was "rather willing"



to come to the same place again. Respondents displeased with their stay in the sanatorium made up about 7%.

**Graph 11. Willingness to return to the health resort**

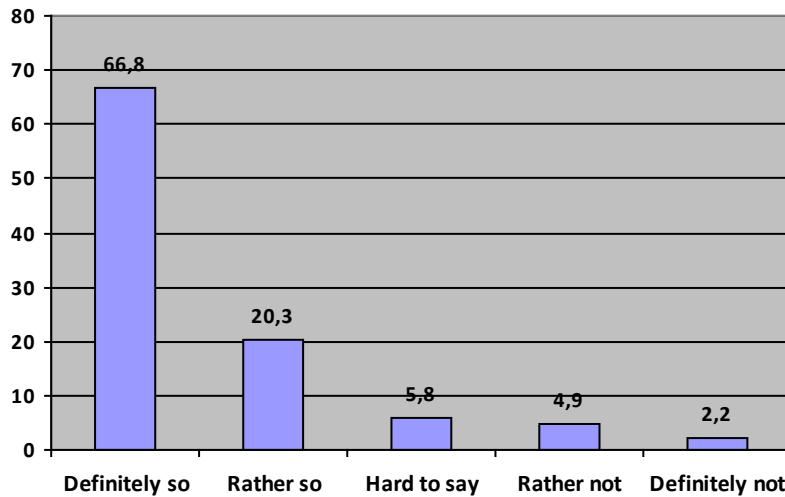

*Source: own study based on research results*

Some respondents did not intend to return to the same resort for sanatorium treatment mainly because: they wished to see other places, it was difficult to get to the resort, or they had to cover considerable distances within the resort to have their treatment. Some also complained about the number and quality of the treatments, or accommodation. Due to various illnesses of the locomotive system, some patients had trouble getting around in mountain resorts – hence they would have preferred to go e.g. to the seaside.

Nearly 74% of respondents would have liked to return to the evaluated health resort for the weekend or summer vacation. Almost 16% stated no such intention.

The wish to return was indicated slightly more often by women, pensioners, working people, and people with an income of 500-1000 PLN per family member.

The reasons why the respondents did not plan to return to the evaluated resort for holidays included: large distance from their place of residence, lack of tourist infrastructure, of tourist attractions, or of sports infrastructure. Other important reasons were also the wish to visit other places, seeing other towns or villages, a squalid locality, and also health problems which made the stay in mountain areas more bothersome.

**MONITORING HEALTH RESORT CUSTOMERS' SATISFACTION AND EXPECTATIONS ON THE EXAMPLE OF THE CUSTOMERS OF THE INNOVATIVE CLUSTER OF HEALTH AND TOURISM "HEALTH RESORTS - PEARLS OF EASTERN POLAND"**

---

**Graph 12. Choosing the health resort for the weekend/summer vacation**

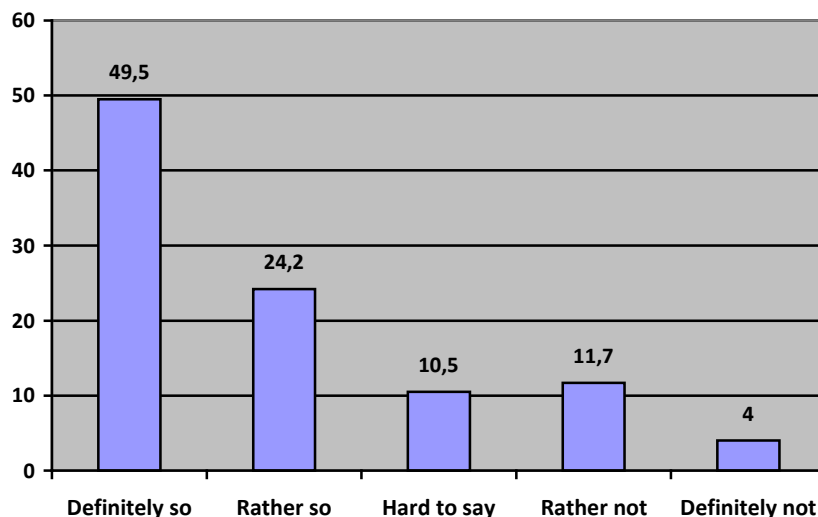

*Source: own study based on research results*

The biggest assets of health resort offers as indicated by the examined patients were mainly the treatment offer and medical care – treatment quality, professional and friendly service by the sanatorium employees. The patients also appreciated good accommodation, living conditions, as well as the salutary climate, air, and peace and quiet in the health resorts.

**Graph 13. Recommending the health resort to family and friends**

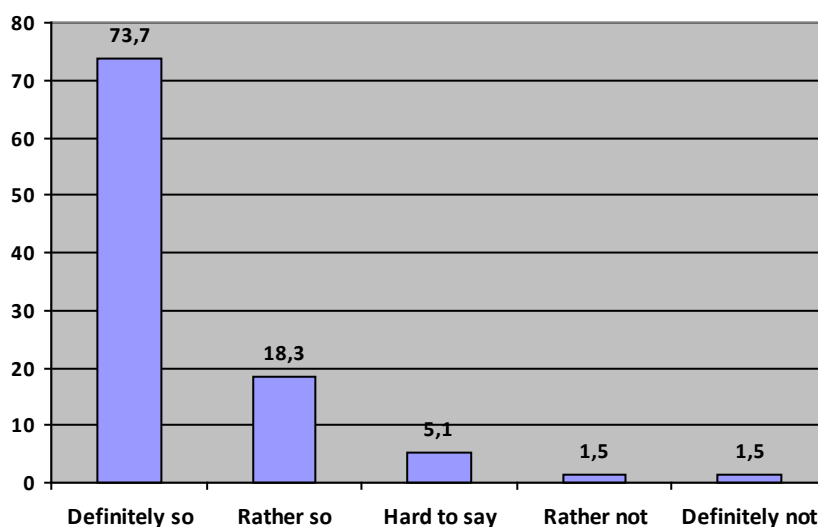

*Source: own study based on research results*

Research shows that 92% of the patients would have recommended the visited health resort to their friends and relatives, compared with only 3% who would not. 5% of respondents did not give a definite opinion. Recommendations for a stay in the particular resort were given slightly more often by elderly people (over 70), people who had stayed in the resort with their families, and patients coming from cities of over 100 thousand dwellers.

The results prove very high satisfaction of patients with their stays in sanatoriums and the high potential and tourist attraction of the examined health resort towns and villages.

### Summary

The results of the conducted research show that in the sanatorium services market there prevail patients whose stay in the health resorts is financed by NFZ, ZUS or KRUS. In most cases, they had no say in choosing the health resort where they were to be treated, and neither did they choose the sanatorium entity the services of which they were to benefit from. The patients go to those resorts mostly in order to have the rehabilitation treatment, but they also use the additional infrastructure of the locality and the entity whose services they use. The level of meeting patients' expectations is influenced by the following elements related to providing sanatorium services:

- service infrastructure (location, equipment, standard of the facilities),
- staff of the service provider (employee number, qualifications, efficiency, individual characters),
- waiting time, timeliness and pace of performing the service,
- customer service system,
- staff working conditions,
- aesthetic appearance and development of the area.

It follows from the research that satisfaction with customer service quality is very high, both as concerns the competence and the friendly attitude of employees. It is worth stressing that the process of customer service is made up by the course of the service, from interesting the customer in one's offer through information, providing the services, to maintaining contact after the customer leaves. An important element of the customer service is managing complaints, which should be done in such a way as to provide a chance to repair the relations with the customer, prevent unfavourable information about the company from spreading, and ensure the employees' motivation to do their duties better. Slightly lower notes than to satisfaction with customer service, but also high ones were given to other elements composing the sanatorium offer of the entities. Noteworthy is the high opinion on the rehabilitation and treatment offer. The examined patients also expressed their considerable satisfaction with elements that made up the offer of the health resort, particularly as concerned security in the resort, and its image. Analysis of open questions shows that patients value the climate of the resorts and fresh air. Noted were also e.g. the well-tended, beautiful park in Busko Zdrój, the well-kept river Tabor in Rymanów Zdrój, clean pavements, flower beds. The climate is also created by buildings typical of health resorts, like pump rooms or the shell-shaped concert venues. Also, certain problems and inconveniences which patients had to contend with were indicated. Littered forests and run-down fitness trails made a negative impression. Unfavourable opinions were also caused by historical buildings falling into ruin, which can still sometimes be seen next to beautifully groomed promenades. It happened that in some sanatoriums the room equipment was obsolete, and the rooms were at least double. In health resorts, more outdoor events should be organised, like concerts, craft fairs, workshops; places e.g. for barbecues could be arranged. Places for tourist entertainment should be provided, e.g. learners' slopes for skiing beginners, cycling routes, walking routes, bike rentals. A

**MONITORING HEALTH RESORT CUSTOMERS' SATISFACTION AND EXPECTATIONS ON THE EXAMPLE OF THE CUSTOMERS OF THE INNOVATIVE CLUSTER OF HEALTH AND TOURISM "HEALTH RESORTS - PEARLS OF EASTERN POLAND"**

---

health resort product can be understood as a coherent composition of elements offered in the market which allows the buyer to satisfy their various needs and achieve the goals that determined the trip.

The patients' satisfaction with their stay is measured by their claims to wish to return to the entity both to stay in a sanatorium and as tourists, and to recommend the entity to their friends and relatives. According to the research results, almost 90% of the respondents claim that they would like to visit the resort again, and nearly 75% of the respondents would choose the resort they had visited for a weekend stay or for summer holidays. Those results show how truly satisfied the patients are.

**References:**

Dz. U. of 2005, No. 167, item 1399 as amended

Griffin J. (2002), *Customer Loyalty: How to Earn It, How to Keep It*, New and Revised Edition, Jossey-Bass Business & Management

Johnson M. D., Gustafsson A. (2000), *Improving Customer Satisfaction, Loyalty, and Profit: An Integrated Measurement and Management System*, Jossey-Bass

Mika M., Jackowska D. (2008), *Formy turystyki zdrowotnej (Health Tourism Forms)*, [in:] W. Kurek (ed.), *Turystyka (Tourism)*, Wydawnictwo Naukowe PWN, Warsaw

# THE MARKETING STRATEGIES OF POLISH EXPORTING COMPANIES ON INTERNATIONAL MARKETS

Jan Wiktor<sup>1</sup>

**Abstract:** *The aim of the paper is to evaluate international marketing strategies of Polish exporters. The paper is based on the results of the grant of the Polish Ministry of Science and Higher Education executed by the Marketing Department of the University of Economics in Krakow. The first section of the paper presents reflections on the identity of Polish companies, the structure of Polish exporters and research methodology. The second part contains a synthesis of the research results. The architecture of marketing strategies implemented by Polish exporters is presented from the point of view of entry modes and business presence strategies in foreign markets.*

**Keywords:** *marketing, marketing strategies, international marketing, Polish exporters, research results*

## Introduction

The paper aims to assess the marketing activities carried out by Polish companies on international markets. Special attention is given to an assessment of the marketing strategies adopted by Polish exporters in their international and global operations. The paper comprises two parts. The first part presents considerations concerning the identity of Polish exporters and the methodological foundations of the conducted research studies. The second part presents a synthetic analysis of the obtained results. The empirical study is the result of the Ministry of Science and Higher Education grant for a team of researchers from the Marketing Department of Cracow University of Economics. The Project entitled “Corporate Marketing Strategies on International Markets” (N N115 042937) was implemented under the author’s supervision in 2009-2011<sup>2</sup>.

## The polish exporter – the problem of identity, research methodology

This part of the paper discusses two issues: the identity of Polish exporters and the methodology of the research study.

Companies operating on the Polish market have different characteristics in terms of their business activities, legal and ownership status as well as capital and organizational structures. Poland is an open market as part of the EU’s internal market. It has no internal borders and it is not protected by customs barriers in its interactions with Community member states. Moreover, it applies unified European regulation in the area of trade exchange and business activities. As an internal and unified market it is based on the four fundamental principles – the free movement of people, goods, services and capital. Poland’s membership in the EU, the openness of the market to European and world capital (outside the EU) and a great potential for expanding in international markets constitute an interesting area for research and empirical studies.

The Polish market is a significant and attractive target for foreign capital, offering favourable entry and business conditions. Foreign companies and their subsidiaries registered in Poland are

---

<sup>1</sup> Faculty of Management, Cracow University of Economics, wiktorjw@uek.krakow.pl

<sup>2</sup> The concept and results of research are presented in the monograph entitled *Marketing Strategies of Polish Exporting Companies on International Markets* (Wiktor, J. W. and P. Chlipała, eds. 2012) The research team: P. Chlipała, A. Czubała, A. Jonas, T. Smoleń, J.W. Wiktor and A. Żbikowska.

## THE MARKETING STRATEGIES OF POLISH EXPORTING COMPANIES ON INTERNATIONAL MARKETS

---

granted the status of “a Polish company”. This status – in the light of public statistics and Polish regulations in force – is granted to all entities which are registered in Poland and which carry out their activities in accordance with Polish laws. The origins of capital or the entity’s current or planned organizational structures do not have any formal significance. All entities are granted the status of Polish companies upon entering the register of business activities (the REGON data base of the Central Statistical Office in Poland). Consequently, Polish exporters include such European and global companies as Fiat Auto Poland [3, 9], Volkswagen Poznań [4, 16], Arcelor Mittal Poland [5, 11], LG Electronics Mława [7, 49], LG Electronics Wrocław [9, 52] and Philips Lighting [10, 53]<sup>3</sup>.

Polish daughter companies of transnational corporations – as indicated by research studies and analyses – do not confine their operations to the Polish market and engage in international activities by implementing different forms of strategies. Their overseas activities – apart from their formal links with mother companies – are treated as operations carried out by Polish companies and, as such, have a formal impact on the “international activities (volume and structure of exports) of Polish companies”. Companies with Polish capital also implement their development strategies by engaging in internationalization processes and active participation in business operations on overseas markets. Both categories of entities constitute a group of “Polish exporting companies” which implement their marketing strategies in international markets. The paper presents a synthetic and selective assessment of their overseas operations.

The other discussed issue concerns the methodology of the conducted research study. The entities analysed under the Project include a group of “Polish exporting companies”. The problem of the identity of a “Polish company” is discussed in the previous paragraph. It is necessary to make a comment on the category of an “exporting company” and the term “export”.

The term “exporting company” is used in the Project in a different meaning than the one suggested by definitions and the economic content of “export” or by European legal solutions (e.g. the VAT act). An exporting company is any entity which sells its products not only outside the customs territory of its country but also within this territory as part of intra-Community supplies. It results from the characteristics of the EU’s internal market and its fundamental freedoms including the free movement of goods and services.

The formal and legal solutions and the principles of public statistics do not provide the possibility of establishing a data base that would comprise detailed information on exporting companies. Consequently, choosing a sample of “Polish exporters” turned out to be a major problem in the course of implementing the Project (Chlipała 2012). The problem was finally resolved. Quantitative analyses were based on two samples. The first sample was composed of the companies which featured *Polityka*’s ranking of 100 Polish largest exporting companies in 2005-2009 (group “E-100”). In the five-year period the sample included 173 companies. Twenty-nine companies responded to the surveys conducted from November 2010 to May 2011 (17%). The second sample was based on companies included in the data base of *Poland Export*’s portal. It is one of the major portals dedicated to Polish export, its problems, development conditions and prevailing trends. The portal has a base of approx. 20,000 Polish companies which, to varying degrees, sell their products outside the Polish territory<sup>4</sup>. On-line surveys in this group of companies were conducted from April 2011 to May 2011. Companies received e-mails (4 reminders), accompanied by a cover letter and a link to an electronic questionnaire. At the time of conducting the survey the website recorded 730 hits (3.7%) along with answers to some of the questions (in most cases general and selective information on company

---

<sup>3</sup> These companies featured the ranking of “100 Polish largest exporters” in 2011. Numbers in brackets – the first one indicates the position in the ranking of Polish exporters, the second one – position among Polish 500 largest companies.

<sup>4</sup> According to estimates, Polish exporters include some 140,000-160,000 enterprises, representing 8.5%-10.00% of the total number of companies registered in 2011 in the Regon data base.

operations). Only 112 questionnaires were qualified for further analyses (0.6% of companies registered in *Poland Export's* data base, group "E-P"). Quantitative analyses covered 141 companies which qualified as "Polish exporters".

The analysed group of companies had the following characteristics:

1. Headcount: 730 employees in both groups of companies. However, distribution of firms was diversified: micro businesses with up to 10 employees accounted for 23% of the sample, large companies with 250-1000 employees - 17%, and those with more than 1,000 employees - 13%. The largest analysed companies had 22,000 and 18,000 employees.
2. Type of company: an independent entity - 74%, capital group - 11%, a daughter company of a foreign enterprise - 15%.
3. Industry – companies represented various forms of business activity, classified - in accordance with public statistics principles - as different sections and divisions of the national economy. The largest group of companies represented trade (17%), the metal industry (15%) as well as construction, food, car and machine industries (9%-11%). The term "trade" requires further specification. It does not signify trade in its literal meaning. An in-depth analysis of a large number of companies indicates that trade also represents the sale of manufacturers' products and a method for indirect export applied by several entities (e.g. members of a capital group).
4. The study identified 17 different countries as geographic overseas sales targets. The major countries included Germany (55% of respondents), the Czech Republic and France (26%), Russia (25%) and Ukraine (24%). The responses confirm the macroeconomic statistics and geography of Poland's foreign trade - after 2009, Poland's major export targets include 1. Germany (26.2%), 2. France (6.9%), 5. the Czech Republic (5.8%), 7. Russia (3.7%)<sup>5</sup>. This classification reflects the concentration of marketing activities carried out by exporters on one specific market. For most companies such a market generates more than 50% of export revenues, being the major overseas sales target.
5. The internationalization ratio ( $W_{Ex}$ ) was a significant characteristic of the analysed companies. It expresses the relation between export and total sales revenues. It provides information on the company's international activities and the significance of overseas markets in accomplishing corporate missions. In the case of *Polityka's* 100 largest exporters  $W_{Ex}$  was at the level of 47.5%, and for the group of 112 companies from *Poland Export's* portal – 44.1%. These figures are comparable, indicating an important role of international activities in both groups of companies. It should be noted, however, that the internationalization ratio was considerably different for the particular entities within E-100 and E-P groups with some of companies starting their international operations ( $W_{Ex}$  at the level of 0-10% for 20% of companies) as well as those which export nearly all their products (90%-100%) (accounting for 8.7% of entities representing E-100 - 15 out of 173 companies).
6. The identity of E-100 companies is marked by their position in Polish exports. A detailed analysis confirms a large share of 100 largest exporters in Poland's total exports. In 2005-2009, these companies accounted for 1/3 of Poland's exports (36.3%). E-100 companies perform a key function in the structure of Polish foreign trade and can be treated as a barometer of economic prosperity and a driver of Poland's economy and its export.

---

<sup>5</sup> See: Statistical Yearbook of Foreign Trade 2010, "Gospodarka i handel zagraniczny Polski w roku 2011", Raport 2012

**The architecture of marketing strategies adopted by polish exporters.  
Results of the study**

Due to space limitations of the paper the author presents the results of general and basic empirical research studies. They refer to a synthetic assessment of export marketing strategies and do not focus on the area related to instruments and tools (4Ps). In accordance with the theoretical assumptions, international marketing strategies are classified as entry strategies and business presence strategies (Wiktor et al. 2008; Duliniec, 2009). Both components cover all the issues related to corporate missions and strategies as part of internationalization undertakings.

***Entry strategies***

In this area of strategic decisions the research studies focus on the following issues: the position of internationalization in the missions of Polish exporting companies, the motives of foreign market entry and internationalization, the scope and character of marketing research, various aspects of entry modes – organization, time, economics, and market space as well as specific entry modes, their motives and future possible undertakings (Żbikowska, 2012).

The results of the study indicate a very positive attitude of the analysed companies to the challenges posed by contemporary markets and economies – increasingly open, deregulated and integrated at the European and global level. This is an important conclusion. Companies respond to the above challenges – at a microeconomic level – by actively engaging in the internationalization of their activities (Czubala, 2012). The obtained results indicate the significance of the market motives of foreign expansion. They can be classified as proactive and reactive motives. The first group relates to exporters' efforts to expand the market of their operations, improve their international image, acquire access to new market segments (prospective buyers) and prolong product life cycles – the size of the domestic market is not consistent with their production capacity. Proactive market drivers are related to economic and financial factors – for the majority of entities, especially Polish daughter companies of transnational corporations, the export of products manufactured in Poland at lower costs than in more advanced countries (by equally skilled workers) is more beneficial, constituting an inherent component of expansion strategies adopted by foreign corporations. Reactive motives, on the other hand, are more passive in character. The research study indicates that a foreign market entry is frequently stimulated by business proposals made by foreign partners, participation in overseas fairs and exhibitions, etc. The common characteristic of such undertakings is a “foreign impulse” encouraging Polish companies to engage in export activities. New market opportunities or interesting proposals made by foreign firms arouse the interest of Polish companies in other markets and stimulate the internationalization of their activities. The factors which belong to the first group describe international strategies adopted by E-100 companies, while the other drivers are characteristic of E-P companies, small and medium businesses as well as those which are at the initial stage of foreign expansion.

An important role in entry strategies adopted by Polish exporters is played by the market size – its potential and absorptiveness – as well as by the possible attractiveness of carrying out overseas operations. The attractiveness of markets is affected by the stability of target countries, foreign exchange risk, the transparency of legal regulations and business practice on foreign markets. A number of companies stress difficulties in entering the markets of Russia, Ukraine and CIS countries as well as the problems of carrying out long-term operations in these territories. Such issues are indicated by a number of companies which represent the *Poland Export* portal.

International expansion relies heavily on marketing research which provides a basis for rational management decisions. Respondents regard marketing research to be a reliable and systematic method for collecting information which is of key importance from the point of view of strategic and



operational management. The results of the Project give interesting insights into the role of research in developing entry strategies. Approximately 40% of respondents carry out comprehensive marketing research studies (as defined by the questionnaire). This result may seem surprising, but it should be noted that *ad hoc* analyses and other sources of information are also widely applied by the participants of the Project. It is an important conclusion – it would not be justified to state that exporting companies do not research their foreign markets – the current and future expansion targets.

Important information provided by respondents concerns a foreign market entry mode and the company's actual engagement in overseas operations. The process of gathering market and marketing information is different in the case of independent and direct market activities as compared with indirect export operations. Indirect export relies more heavily on international agency services.

Nearly 60% of respondents carry out independent market research, while the remaining companies rely on data obtained from their foreign head offices – it refers to daughter companies or information gathered at the level of capital groups and domestic or foreign agents. Such data are usually included in the provisions and clauses of agreements in accordance with the specific requirements imposed by foreign partners and approved by export transaction partners. Important information is also provided by Polish embassies and consulates – the significance of this source of information is mainly stressed by companies featured in *Poland Export*. Most respondents make use of internet information as well as the sectoral analyses and studies of international and global markets. Marketing research carried out independently or supported by head offices or agents focuses on the major factors of the macroenvironment including inflation rates, growth rates as well as political and legal aspects (possible changes in legal regulations). Respondents give little attention to customer needs and preferences on overseas markets. A certain paradox becomes apparent – companies regard the knowledge of consumers as a significant source of competitive advantage in their business presence and competitive strategies. An important question arises in this context: what are the actual sources of marketing information – intuition, experience or assumptions as to short- and mid-term customer expectations? This question is not answered by the surveyed companies.

The obtained results indicate that direct export is the major entry mode adopted by Polish companies (60%). Indirect export is declared by 37% of companies (some entities use both entry modes). Approx. 20% of respondents use other modes, but on a limited scale – foreign direct investment, overseas representative offices, distribution companies, etc. The distribution of answers corresponds to the structure of respondents – there is a clear distinction between answers in the two analysed groups of companies. In the case of 100 largest exporters (E-100) direct entry is affected by their relations with mother companies. The international distribution of products manufactured in Poland is subject to the principles and strategies adopted by foreign corporations. E-P companies, on the other hand, carry out their indirect export activities relying on foreign distribution channels and agents who act as market integrators. The conducted analysis also provides information on the principles and mechanisms of cooperation with foreign buyers – wholesalers, independent trading entities and agents.

A number of companies use waterfall strategies to enter foreign markets (70%). Such strategies reflect the company's cautious and gradual engagement in business activities on selected market segments and the process of learning the principles of operating on international markets. The remaining 30% of companies adopt the sprinkler strategy to enter into overseas markets. This strategy enables companies to benefit from their technological and marketing advantage (gained through a new product, professional services, flexibility, etc.), economies of scale and their lasting position on international markets. This strategy is more frequently adopted by 100 largest exporters from *Polityka*'s ranking than those from *Poland Export*'s data base. The sprinkler strategy is also used by companies which engage in indirect export activities. This differentiation results from capital resources required by the two strategies as well as by the company's participation in the structure of transnational corporations, its position on the international and global market, and – in the case of

## THE MARKETING STRATEGIES OF POLISH EXPORTING COMPANIES ON INTERNATIONAL MARKETS

---

indirect export – the role and position of international agents who operate on a large number of markets and benefit from economies of scale.

### *Business presence strategies*

The Project aimed to identify all the four components of business presence strategies which are described in literatures: 1) a general approach, 2) EPRG model, 3) market competitive strategies, and 4) strategies for servicing buyers. Only some of the objectives were achieved on the basis of the obtained responses (Jonas, 2012). The results of the study provide a basis for general conclusions with regard to competitive and servicing strategies, while they are not satisfactory in terms of assessing the remaining strategies from the point of view of the methodology of scientific research.

In the light of the study it can be concluded that Polish exporting companies rely on two sources of competitive advantage: high quality and attractive prices. High quality which meets world technical and technological standards is stressed by E-100 companies (the largest exporters). Competitive prices are the major source of advantage for *Poland Export* companies. An important remark should be made with reference to prices. According to respondents it is not a nominal price which is a competitive factor but a price referred to all the components of the offering. It is a significant aspect which affects market mechanisms and competition; it is also important from the point of view of the structure of customer needs and preferences. The prices of Polish products in foreign markets reflect value delivered to specific buyers in particular countries. This value, in the light of the study, does not only reflect product utility translated into a given price but it also includes other components – the utility of form, time, place and possession.

An important conclusion of the study is the respondents' declaration concerning their favourable market and competitive position. It correlates with the structure of the largest exporters, their position in the structure of Polish exports as well as their ownership structure (daughter companies of international corporations). Moreover, Polish enterprises are actively engaged in competing on international markets. Respondents stress their openness, innovativeness and creativity. The brand "made in Poland" is also a source of competitive advantage. It is indicated, with regard to both current and future operations, by the entities whose internationalization coefficient exceeds 80%. This is an important conclusion – foreign markets are more significant for these companies in terms of the volume of sales.

The questions related to "a general approach" to foreign markets and the ways in which they are served (EPRG) are not satisfactorily answered by respondents. Therefore, the assessment of these components is indirect in character and based on rough estimates – it offers some generalised statements with regard to product offerings, their components, competitive strategies and the set of utilities offered to overseas buyers. The obtained results, with some reservations, can be placed at the borderline of the ethnocentric and polycentric approach. Nearly 90% of respondents develop independent marketing plans for particular markets. It can, to some extent, indicate a polycentric character of activities reflecting an adaptive approach in international marketing activities. On the other hand, significance attributed to the "made in Poland" brand as an important source of competitive advantage suggests an ethnocentric approach which corresponds to marketing standardization at the international level.

### **Concluding remarks**

The presented results of the research study describe the architecture of marketing strategies adopted by Polish exporting companies on international markets. The study is based on the research Project of the Ministry of Science and Higher Education implemented in 2009-2011 by the Marketing Department of Cracow University of Economics.

The sample of the analysed Polish exporting companies constitutes an interesting area for cognitive and methodological research. However, it does not provide a basis for formulating generalised conclusions. The obtained results lead to some cautious conclusions concerning the foreign expansion of Polish companies, its motives and conditions. These conclusions are related to entry modes and business presence strategies implemented by Polish enterprises in international markets. Although they provide some insights into international marketing strategies, the social and economic challenges posed by international and global markets require further theoretical and empirical research. Such research can have a broad dimension and include the theoretical and methodological aspects of analysing internationalization models and processes and marketing strategies in contemporary international business. This statement may also encourage international academic centres to undertake studies based on unified methodological principles.

### References

- Chlipała, P. (2012). Pomiar i ocena strategii marketingu międzynarodowego - metodyka projektu badawczego. In: *Strategie marketingowe polskich eksporterów na rynkach międzynarodowych* (Wiktor J. W. and P. Chlipała, eds.), Warszawa: Polskie Wydawnictwo Ekonomiczne, 75-96.
- Czubała, A. (2012). Misja w strategiach rozwoju polskich eksporterów. In: *Strategie marketingowe polskich eksporterów na rynkach międzynarodowych* (Wiktor J. W. and P. Chlipała, eds.), Warszawa: Polskie Wydawnictwo Ekonomiczne, 97-115.
- Duliniec, E. (2009). *Marketing międzynarodowy*. Warszawa: Polskie Wydawnictwo Ekonomiczne.
- Gospodarka i handel zagraniczny Polski w 2011 r.* (2012). Warszawa: Instytut Badań Rynku, Konsumpcji i Koniunktur.
- Statistical Yearbook of Foreign Trade* (2010). Warszawa: GUS
- Jonas, A. (2012). Strategie obecności polskich eksporterów na rynkach międzynarodowych. In: *Strategie marketingowe polskich eksporterów na rynkach międzynarodowych* (Wiktor J. W. and P. Chlipała, eds.), Warszawa: Polskie Wydawnictwo Ekonomiczne, 155-177.
- Wiktor, J. W. and P. Chlipała, eds. (2012). *Strategie marketingowe polskich eksporterów na rynkach międzynarodowych*. Warszawa: Polskie Wydawnictwo Ekonomiczne.
- Wiktor, J. W. et al. (2008). *Marketing międzynarodowy. Zarys problematyki*, Warszawa: Polskie Wydawnictwo Ekonomiczne.
- Żbikowska, A. (2012) Strategie wejścia polskich eksporterów na rynki zagraniczne. In: *Strategie marketingowe polskich eksporterów na rynkach międzynarodowych* (Wiktor J. W. and P. Chlipała, eds.), Warszawa: Polskie Wydawnictwo Ekonomiczne, 116-154.



# CREATING THE VALUE OF GLOBAL BRANDS IN THE LIGHT OF THE ANALYSIS OF THE "BEST GLOBAL BRANDS" RANKING

Paweł Chlipala<sup>1</sup>

**Abstract:** *The paper discusses the issue of brand value in international markets and the creating of the value of global brands. The author focus on measurement of brand value – the effects of corporate activities aimed to build and increase brand value. With this purpose in mind, the author analyses the "Best Global Brands" ranking which features 100 most valuable global brands. The presented results cover all the rankings published by Interbrand in 2001–2011. The major objective of the paper is to analyse the geographical and economic aspects of the rankings of the world's most valuable brands. An attempt is made to identify the origin of the most valuable brands. The economic aspect refers to the correlation between brand value and companies' core activities. The analysis of both areas considers time-related factors to identify the prevailing and future trends on the market of the most valuable brands.*

**Keywords:** *brand, global brand, brand value, ranking of brands, most valuable global brands*

## Introduction

Brand value is one of the key issues related to corporate marketing policies. Attention given to the brand value of offered products results from two basic factors: activities aimed to increase brand value and the measurement of brand value. The brand is one of the organization's major intangible assets regarded to be an integral component of the intellectual capital. Therefore, brand management can be treated in the same way as the management of other corporate intellectual resources, and its objective should be to create, increase and measure brand value. This policy is referred to as value creation and value extraction (Chatzkel, 2002).

Brand creation in international markets is part of the general brand strategy and it reflects the choice between generic products and branded products, and in the latter case decisions are made with regard to brand ownership and the scope of brand impact depending on the brand's local or global impact (Oczkowska, 2008). The global brand can benefit from economies of scale, reducing marketing costs as well as the costs of servicing target buyers. The use of global brands is justified when demand for products is not conditioned by cultural factors. It refers to renowned designs and prestigious brands which are easily identified by clients, especially mobile ones (Duliniec, 2004).

Measuring brand equity poses a great challenge for contemporary companies and brand market monitoring institutions. It is a complex process because of its characteristics. Measurement is emotional, irrational, intangible (values, attitudes, beliefs) and symbolic (Adcock, 2000). Measuring brand equity is difficult due to a number of "soft" components of the process which can hardly be expressed by parameters. Measuring tools must be diversified, interactive (contacts with clients) and based on qualitative criteria (Moeller and Landry, 2009). Depending on the adopted methodology, the results of measuring the same brand may be different – measuring the brand equity of global products cannot be standardised. At the same time, the issue of measuring brand equity has been attracting much attention since the end of the 20th century – brands, as already noted, constitute the company's major assets. Contemporary companies value their intangible assets, including brands, for the needs of their shareholders and to communicate such information to clients in their efforts to strengthen the company's position and improve product image perceived by customers (Webster, 2002).

---

<sup>1</sup> Faculty of Management, Cracow University of Economics, pawel.chlipala@uek.krakow.pl

## **CREATING THE VALUE OF GLOBAL BRANDS IN THE LIGHT OF THE ANALYSIS OF THE "BEST GLOBAL BRANDS" RANKING**

---

Literatures offer a number of approaches to brand equity measurement. The proposal made 20 years ago by Aaker is still valid; it identifies 5 categories (Hollensen, 2011):

1. Brand loyalty – repeated purchases despite competitive offerings,
2. Brand awareness – recognizability level and brand knowledge,
3. Perceived quality – quality perceived by clients,
4. Brand associations – values attributed to brands and emotional attitudes of clients,
5. Other proprietary brand assets – trademarks, patents and marketing channel relationships.

On the basis of various brand equity concepts Fill (2005) proposes three dimensions of brand equity measurement:

1. Brand dominance: a measure of its market strength and financial performance,
2. Brand associations: a measure of the beliefs held by buyers about what the brand represents and stands for,
3. Brand prospects: a measure of its capacity to grow and extend into new areas.

Brand equity concepts vary in terms of their structure and measuring components. It should be noted that different concepts give attention both to financial and marketing aspects. Brand value is perceived from the perspective of internal competences and resources, but the major factor is the way in which it is perceived by consumers and their behaviour. Brands are assessed in terms of their present value as well as projected cash flows.

The paper focuses on the problem of creating brand value from the point of view of the measurement process. The analysis concentrates on global brands which target clients worldwide and which have the highest value as a result of economies of scale and the number of buyers. The further considerations focus on the methodological aspects of measurement and the results of the analysis of the "Best Global Brands" ranking compiled by Interbrand. The main objective of the analysis is to diagnose the position of the most valuable global brands and to describe how their value changes in the course of time. The presented results cover all the rankings published by Interbrand in 2001-2011, featuring 100 best global brands. The problem is presented in its geographical and economic dimension. An attempt is made to identify the origin of the most valuable brands and determine world dominance in this field. As regards the economic aspect, the author identifies the correlation between brand value and companies' core activities. The analysis of both issues considers time-related factors to identify the prevailing trends on the market of the most valuable brands and to present forecasts for the coming years.

### **The rankings of brands – a source of information on the value of global brands**

Over the recent years brand equity measurement has become an important issue for companies as well as for the organizations which manage brand creation and monitor the market of global brands. It leads to the publication of a number of rankings which present the most valuable global brands. Table 1 presents the examples of popular rankings of brands:

- Interbrand's "Best Global Brands" – compiled annually since 2001 and featuring 100 most valuable global brands,
- MillwardBrown's "BrandZ Top 100 Most Valuable Global Brands", compiled since 2006,
- European Brand Institute – Eurobrand's "Top 100 Brand Ranking – Brand Corporations Worldwide", published since 2008.

**Table 1. The 2011 list of most valuable global brands – selected ranking agencies**

Position in ranking	Interbrand		MillwardBrown		Eurobrand	
	Brand	Value (\$m)	Brand	Value (\$m)	Brand	Value (\$m)*
1	Coca-Cola	71,861	Apple	153,281	Apple	53,998
2	IBM	69,905	Google	111,498	Coca-Cola	42,696
3	Microsoft	59,087	IBM	108,849	Microsoft	39,791
4	Google	55,317	McDonald's	81,016	Google	37,344
5	GE	42,808	Microsoft	78,243	IBM	35,847
6	McDonald's	35,593	Coca-Cola	73,752	McDonald's	34,844
7	Intel	35,217	at&t	69,916	at&t	34,536
8	Apple	33,492	Marlboro	67,522	P&G	34,275
9	Disney	29,018	China Mobile	57,326	Pepsico	33,484
10	Hewlett-Packard	28,479	GE	50,318	Philip Morris	33,321

*\*Eurobrand's original figures are denominated in EUR. USD values based on the exchange rate at the end of December 2011- European Central Bank: 1 EUR = 1.29 USD*

*Source: Interbrand (2011), WPP and MillwardBrown (2011), European Brand Institute (2011)*

A quick analysis of 10 most valuable brands according to 3 prestigious rankings indicates huge differences in valuations. MillwardBrown's (2011) most valuable brand more than doubles Interbrand's (2011) best brand, being 3 times as high as Eurobrand's (2011) leading brand. It is even more spectacular that a triple difference between MillwardBrown's (2011) and Eurobrand's (2011) leading position refers to the same brand - Apple. The difference in the valuation of this brand between Interbrand (2011) and MillwardBrown (2011) is five-fold. Interbrand's (2011) list does not feature China Mobile, while it ranks 9th on MillwardBrown's (2011) list and 12th in Eurobrand's (2011) ranking. There are countless examples of such differences on the lists of 100 most valuable brands. The existing discrepancies lead to some important questions concerning ranking lists: what is the source of such differences in brand value and how are rankings compiled? How reliable are the figures cited by particular agencies? Do the analyses for compiling ranking lists make any sense?

In order to offer answers to these questions, it is necessary to have a closer look at the methodological issues. The organizations whose rankings are presented in Table 1 apply different methodologies. Tables 2 and 3 present the approaches adopted by MillwardBrown (2011) and Interbrand (2011). European Brand Institute cites renowned brand equity experts but it does not present its methodology, which makes the assessment of rankings difficult. Brand equity measurements presented by MillwardBrown (2011) and Interbrand (2011) are based on similar principles – economic benefits derived from the possession of branded services and goods. Both agencies give attention to discounted cash flows related to brands. Each methodology estimates the significance of brands in consumer choices and considers consumer behaviour in relation to branded products.

**CREATING THE VALUE OF GLOBAL BRANDS IN THE LIGHT OF THE ANALYSIS OF THE "BEST GLOBAL BRANDS" RANKING**

**Table 2. Methodology for estimating brand value - MillwardBrown**

<b>Steps</b>	<b>Description of activities</b>
Step 1: Calculating Branded Earnings	Assigning an appropriate portion of company earnings to particular brands. Analyses are based on various financial data, e.g. annual reports.
Step 2: Calculating Financial Value	Estimating future earnings prospects with the use of BrandZ™ formula. This component assesses future earnings prospects as a multiple of current earnings.
Step 3: Determining Brand Contribution	Valuation of factors which may influence the value of the branded business, for example price, convenience, availability and distribution. This step includes so called Brand Contribution for estimating the brand's uniqueness and its ability to stand out from the crowd, generate desire and cultivate loyalty.  The company conducts regular and cyclical studies, Currently, they cover over two million consumers and more than 50,000 brands in over 30 countries.
Step 4: Calculating Brand Value	The last step calculates brand value by multiplying brand financial value by brand contribution.

*Source: MillwardBrown (2011)*

**Table 3. Methodology for estimating brand value - Interbrand**

<b>Steps</b>	<b>Description of activities</b>
Financial Performance	Assessment of return on investment based on Economic Value Added (EVA). Calculations are based on net operating profit after tax (NOPAT) less industry weighted average cost of capital (WACC). The financial performance is analysed for a five-year forecast and for a terminal value.
Role of the Brand	Estimation of the portion of the decision to purchase that is attributable to brand - this is exclusive of other aspects of the offer like price or feature. Necessary data for estimation are gathered, depending on the brand, from one of three methods: primary research, a review of historical roles of brand for companies in that industry, or expert panel assessment.  Estimation of the role of the brand in buying decisions leads to an amount expressed in percentage terms which is multiplied by the economic profit of the branded products or services to determine the amount of branded earnings that contribute to the valuation total.
Brand Strength	Ten dimensions of brand activation are considered (internal factors – clarity, commitment, protection and responsiveness – describing the organization's approach to brands and its ability to manage them effectively, and external factors – authenticity, relevance, differentiation, consistency, presence and understanding – describing the brand's market and marketing potential and the related communication opportunities). Brand strength measures the ability of the brand to secure the delivery of expected future earnings. The brand strength inversely determines, through a proprietary algorithm, a discount rate. That rate is used to discount branded earnings back to a present value based on the likelihood that the brand will be able to withstand challenges and deliver the expected earnings.

*Source: Interbrand (2011)*



There are minor differences between Interbrand (2011) and MillwardBrown (2011) methodologies. The two agencies use their own brand structure concepts and principles for estimating earnings and discounting future cash flows generated by brands. The differences result from the fact that estimations are considerably affected by qualitative methods as well as expert and client opinions. In this context the reliability of calculations raises a number of doubts (considering such huge differences, one of the agencies is likely to make erroneous judgments). This issue, however, can be viewed from a different perspective. Brand value, similarly to other intellectual resources, represents intangible assets. Unbiased assessments in this area pose major problems for measuring the intellectual capital and, in particular, brand value. It should be stressed that assessing intangible assets is a pioneer research activity. Also, the agencies which select and measure best global brands must choose from a huge number of products. For example *Interbrand is qualifying for its rankings the product or service that have brand value in excess of \$1 billion, records at least one-third of its sales outside the home base and avails its financial and marketing data to the general public. It causes that many brands as Wal-Mart or BBC are eliminated (Chu and Keh, 2006)*. Apart from differences in brand value assessments, ranking lists can be viewed from a more synthetic perspective and provide insights into certain patterns and trends in assessing the most valuable brands. Therefore, the author believes that the conclusions of the overall analysis are valuable, but they should be interpreted with some reservations.

It is difficult to make judgments as to which of the presented methodologies is more reliable. The agencies only present their valuation concepts. The analysis presented in the paper is based on Interbrand's ranking. This choice results from the agency's experience – its reports have been published for more than 10 years providing the most detailed information on the agency's methodological approach: brand structure and value calculation methods.

### **The value of global brands – an analysis of the "Best Global Brands" ranking**

The main subject of the analysis of the Interbrand's rankings published in 2001 and 2011 was to explore geographical and economical structure of brands equity. The problem of author's interest was accumulation of the best global brands value, according to the Pareto's 20-80 rule. Interbrand's data permitted to determine the complex value of most expensive global brands and to indicate the countries' and region's share of the total value of best global brands. The usage of historical data from "Best Global Brands" rankings provided the opportunity to indicate the main trends the most valuable brands equity and to make prediction the future value of 100 best global brands. There was used linear regression to estimate these values. Interpreting the results of prediction it should be taken into consideration this method has some restrictions: historical data is expanded to the future, but contemporary, turbulent companies' environment can influence changes, that could not be included in the forecast. Therefore predictions presented below should be treated us background for the qualitative estimations.

Table 4 presents the total value of best global brands published in "Best Global Brands" by Interbrand in 2001–2011.

The total value of 100 best global brands exceeds one trillion US dollars (1, 258, 151, 000, 000), representing a 27% increase as compared with the year 2001. Considering global inflation rates, changes were not considerable. The 2002-2003 period recorded a 1% decrease which was due to the US economic crisis in 2007. An increase in equity value was recorded as late as in 2011. The list of 100 most valuable brands is characterised by a high level of concentration. In 2011, 10 most valuable brands accounted for 37% of the ranked brands, while 20 leading brands reached the level of 55% of the total value. The 2001–2011 period does not record any major differences in this trend.

**CREATING THE VALUE OF GLOBAL BRANDS IN THE LIGHT OF THE ANALYSIS OF THE  
"BEST GLOBAL BRANDS" RANKING**

**Table 4. Total value of best global brands - Interbrand**

Year	Value (\$m)	Value of Top-20 (\$m)	Value of Top-10 (\$m)
2011	1,258,151	698,212	460,777
2010	1,201,257	652,644	433,125
2009	1,158,304	628,290	422,901
2008	1,214,397	645,408	424,934
2007	1,157,785	618,658	411,588
2006	1,092,724	587,020	396,569
2005	1,045,060	563,830	388,359
2004	995,595	551,751	381,123
2003	973,952	555,338	386,575
2002	976,657	555,559	387,850
2001	988,291	588,454	409,661

*Source: author's research*

Table 5 presents the structure of brand ownership in 2011 according to Interbrand. Nearly every second brand belongs to a US company. These brands account for more than 60% of the total value of brands of the "Best Global Brands" ranking. It results from the fact that an average value of US brands is higher than world average values (10 first positions taken by US companies – Table 1). The highest position of a non-US company is taken by Toyota (11th). Since the first publications the first 10 positions have been taken by US brands; in the earlier years Top-10 included Nokia (2010 – 8th, 2009 – 5th, 2005 – 6th, 2001 – 5th) and Toyota (2009 – 8th, 2005 – 9th). The US dominance is also confirmed by figures presented in Table 6. The list presents brands by continent - "Best Global Brands" indicate that North America is mainly represented by US brands, several Canadian brands and a small percentage of Mexican brands.

**Table 5. Brand ownership structure – 2011 "Best Global Brands" ranking**

Country	Number of brands	Brand value (\$m)	average brand value (\$m)	country's share in total value (%)
United States	49	793,913	16,202	63.1
Germany	10	108,431	10,843	8.6
Japan	7	85,387	12,198	6.8
France	7	60,021	8,574	4.8
Switzerland	5	30,386	6,077	2.4
United Kingdom	5	27,466	5,493	2.3
Netherlands	3	16,950	5,650	1.4
Italy	3	16,148	5,383	1.3
South Korea	2	29,435	14,718	2.3
Sweden	2	28,322	14,161	2.3
Canada	2	15,939	7,970	1.3
Spain	2	13,153	6,577	1.2
Finland	1	25,071	25,071	2.0
Mexico	1	3,924	3,924	0.3
Taiwan	1	3,605	3,605	0.3

*Source: author's research*

An analysis of the share of the particular continents in the structure of the most valuable brands in 2001–2011 indicates that the US share declines in favour of European brands. In 2001, the US share accounts for 76%, and in 2011 – 65%. In 2001, European brands account for 17% of the total value of 100 best global brands according to Interbrand, while in 2011 their share amounts to 26%. The remaining brands are represented by Asian companies from Japan and Korea. According to “Best Global Brands”, German brands have the strongest position among European companies. A strong position in the recent years has been held by French brands. All the European brands, with the exception of Switzerland, represent EU member states.

**Table 6. The geographical distribution of the values of brands – ”Best Global Brands”**

Year	North America		Europe		Asia	
	number of brands	value of brands (\$m)	number of brands	value of brands (\$m)	number of brands	value of brands (\$m)
2011	52	813,776	38	325,948	10	118,427
2010	55	796,590	37	299,263	8	105,404
2009	53	739,938	38	308,124	9	110,242
2008	54	780,779	37	316,854	9	116,764
2007	53	751,555	36	287,977	11	118,253
2006	52	721,982	37	264,126	11	106,616
2005	53	708,031	37	242,138	10	94,891
2004	58	706,519	34	205,373	8	83,703
2003	63	709,117	29	183,295	8	81,540
2002	66	730,273	27	170,582	7	75,802
2001	64	747,809	29	166,357	7	74,125

Source: author’s research

Table 7 presents the industry structure of the most valuable brands in 2011 according to Interbrand. The electronics and automotive industries dominate the list in terms of quantity as well as value. High positions are held by business services and financial services as well as FMCG products including beverages. The highest average value of brands is represented by computer software manufacturers and business services – the companies whose products are based on intangible and knowledge-related resources.

The data presented in Table 7 can be analysed in terms of geographical dominance. Most leading industries are represented by the United States. The highest positions in electronics are held by ”Intel”, ”Apple” and ”hp”, and in business services – ”IBM”, ”Cisco” and ”Oracle”. The industries in which the leading positions in terms of value are held by non-US brands include the automotive industry: ”Toyota”, ”Mercedes” and ”BMW” as well as luxury goods – the only area of European dominance. This industry is represented by ”Louis Vuitton”, ”Gucci” and ”Hermès”.

**CREATING THE VALUE OF GLOBAL BRANDS IN THE LIGHT OF THE ANALYSIS OF THE  
"BEST GLOBAL BRANDS" RANKING**

**Table 7. The structure of brands by industry - "Best Global Brands" in 2011**

<b>Industry</b>	<b>Number of brands</b>	<b>Industry leaders</b>	<b>Total value (\$m)</b>	<b>Average value (\$m)</b>
Electronics	14	1. United States, 2. United States, 3. United States	213,510	15,251
Automotive	12	1. Japan, 2. Germany, 3. Germany	142,212	11,851
Business Services	5	1. United States, 2. United States, 3. United States	135,023	27,005
Beverages	4	1. United States, 2. United States, 3. Switzerland	104,170	26,043
Financial services	14	1. United States, 2. United States, 3. United Kingdom	100,668	7,191
FMCG	11	1. United States, 2. United States, 3. France	90,356	8,214
Internet Services	4	1. United States, 2. United States, 3. United States	82,293	20,573
Diversified	5	1. United States, 2. Germany, 3. United States	63,902	12,780
Computer Software	2	1. United States, 2. United States	63,257	31,629
Luxury	7	1. France, 2. Italy, 3. France	54,096	7,728
Restaurants	4	1. United States, 2. United States, 3. United States	49,250	12,313
Media	3	1. United States, 2. Canada, 3. United States	44,916	14,972
Alcohol	7	1. United States, 2. France, 3. United States	36,370	5,196
Apparel	3	1. Sweden, 2. Spain, 3. United States	28,564	9,521
Sporting Goods	2	1. United States, 2. Germany	20,682	10,341
Transportation	1	1. United States	12,536	12,536
Home Furnishings	1	1. Sweden	11,863	11,863
Energy	1	1. Netherlands	4,483	4,483

*Source: author's research*

Table 8 presents the share of leading brands in the total value of "Best Global Brands". This share is stable in character. Since 2001, the highest value has been represented by electronics, but its share records a slightly declining trend, while business services show a slight increase. The brands representing financial services increased their share in the total value of brands until the beginning of the financial crisis. The largest increase in the total value was recorded by Internet Services brands with 4 brands featuring Interbrand's ranking since 2004. Faster than average increases are expected for internet services in the coming years, which is less likely for business services.

**Table 8. The share of leading brands in the total value of 100 best global brands according to Interbrand (%)**

Year	Electronics	Automotive	Business Services	Beverages	Financial services	FMCG	Internet Services
2011	17	11	11	8	8	7	7
2010	16	11	10	9	8	8	6
2009	17	11	10	8	7	8	5
2008	16	12	9	8	11	7	4
2007	16	12	9	8	12	7	3
2006	17	12	9	8	10	7	3
2005	17	12	9	9	10	8	2
2004	16	12	10	9	10	8	2
2003	17	11	9	10	8	8	1
2002	18	11	9	9	8	7	1
2001	20	12	9	9	6	6	1

Source: author's research

Despite global economic instability the value of the best brands is likely to rise steadily. It is confirmed by historical data and the fact that new brands appear on ranking lists every year, replacing the brands which deteriorate in value. Table 9 presents the results of a simplified forecast based on trend extrapolation. The forecast indicates that the most valuable brands are likely to record an increase by several per cent as compared with 2016, and the total increase in 2016 as compared with 2011 is expected to reach the level of 11%. A relatively faster general increase in value is expected for as compared with an increase in the most valuable brands – they are likely to decrease in value in 2012 and 2013, reaching the following levels in 2016: Top-20 – an increase by 5%, Top-10 – an increase by 2%.

**Table 9. Total value forecasts - Interbrand**

Year	Value (\$m)	Value of Top-20 (\$m)	Value of Top-10 (\$m)
2016	1401199	731204	95493
2015	1370735	718494	89525
2014	1340271	705784	83556
2013	1309807	693074	77588
2012	1279343	680364	71620

Linear regression for the total value of brands  $y = 30464x + 913775$ ; for Top-20:  $y = 12710x + 527844$ ; for Top-10:  $y = 5968,3x + 373596$

Source: author's research

**CREATING THE VALUE OF GLOBAL BRANDS IN THE LIGHT OF THE ANALYSIS OF THE  
"BEST GLOBAL BRANDS" RANKING**

The projected shares of the particular continents in 100 most valuable brands are based on linear regression. The data indicate that around the year 2015 the shares of North America and Europe are likely to reach the same level of 44%. In the light of the position and increase in the value of US best brands this scenario is not realistic. However, the share of US brands is likely to decrease in favour of Asian brands.

Table 10 presents the value of selected brands in particular Interbrand's rankings. Projected values are based on linear regression. The figures should be treated with caution – it is a simplified forecast which does not consider a number of external factors. However, the outlined trends are very likely.

**Table 10. The value of selected brands - "Best Global Brands" in 2001–2011, trend extrapolation for 2012-2016 (\$m)**

<b>Year</b>	<b>Coca-Cola</b>	<b>IBM</b>	<b>Microsoft</b>	<b>Google</b>	<b>GE</b>	<b>Apple</b>
2016	69,365	73,589	53,880	127,178	50,089	37,682
2015	69,281	71,958	54,555	119,426	49,663	35,411
2014	69,119	70,326	55,230	111,673	49,237	33,139
2013	69,119	68,695	55,905	103,920	48,811	30,868
2012	69,037	67,064	56,580	96,168	48,385	28,597
2011	71,861	69,905	59,087	55,317	42,808	33,492
2010	70,452	64,727	60,895	43,557	42,808	21,143
2009	68,734	60,211	56,647	31,980	47,777	15,433
2008	66,667	59,031	59,007	25,590	53,083	13,724
2007	65,324	57,090	58,709	17,837	51,569	11,037
2006	67,000	56,201	56,926	12,376	48,907	9,130
2005	67,525	53,376	59,941	8,461	46,996	7,985
2004	67,394	53,791	61,372	-	44,111	6,871
2003	70,453	51,767	65,174	-	42,340	5,554
2002	69,637	51,188	64,091	-	41,311	5,316
2001	68,945	52,752	65,068	-	42,396	5,464

*Source: author's research*

The analysis covers 5 leading brands which had the highest value in 2011, as well as "Apple", the 8<sup>th</sup> brand in Interbrand's ranking and the leading brand in the other rankings (Table 1). Each company represents a different industry: "Coca-Cola" – beverages, "IBM" – business services, "Microsoft" – Computer Software, "Google" – internet services, "GE" – diversified, "Apple" – electronics. It is the industry that determines an increase in the value of brands. Coca-Cola, the leader of Interbrand's ranking since 2001, is likely to decrease its value in favour of brands based on knowledge and high technology which represent a greater potential for expansion.

### Concluding remarks

The paper discusses a broad and significant issue for company activities – creating the value of global brands. Attention is given to brand value which is related to the activities aimed at increasing shareholder value. The measurement of brand value is part of a broadly understood process of valuating corporate intellectual assets. This is a pioneer, difficult and non-standardised process. On the other hand, measuring brand value is of key significance as it represents a major part of corporate value.

Currently, companies as well as organizations which deal with brand development and management show an increasing interest in brand value measurement. This trend is reflected in a number of rankings which feature the most valuable global brands. The fact that a number of global brands are included in prestigious rankings confirms the effective activities in the area of brand value creation as well as the high level of brand awareness among global consumers. The particular rankings represent diversified approaches to brand valuation resulting from different methodologies and brand structure concepts as well as from various qualitative methods for brand value estimation.

The paper presents the author's analysis of the most valuable global brands. The analysis is based on Interbrand's rankings – very old and prestigious rankings based on a transparent methodology. The objective of the paper is to diagnose the geographical and economic position of the most valuable global brands and to discuss the prevailing trends on this market. The analysis indicates that 100 most valuable global brands represent an enormous value which steadily increases and is likely to rise in the coming years. Brand value is highly concentrated - 10 most valuable brands account for nearly 40% of the total value of listed brands. The fastest increase in value is recorded by brands based on knowledge and high technology. The results of the analysis indicate the US dominance in creating most valuable global brands. The leading position of the United States is not likely to be threatened in the near future, but the gap between this country and other nations may gradually decrease.

The analysis of Interbrand's rankings allows specifying two main problems that would be considered in the future research in this field. The first problem is methodological. There is still a big challenge to find objective, accurate measure of brand's value. The second issue is empirical. It concerns comparative studies of data from different rankings. Enlargement data sources can help to eliminate results of wrong brand value estimations and it should be inspiration for a deeper discussion on the methodology of evaluating brand equity.

### References

- Adcock, D. (2000). *Marketing Strategies for Competitive Advantage*. Chichester: John Wiley & Sons.
- Best Global Brands*. 2011. Interbrand (31 July 2012) <<http://www.interbrand.com/en/best-global-brands/best-global-brands-2008/best-global-brands-2011.aspx>>.
- Best Global Brands. Methodology*. 2011. Interbrand (6 August 2012) <<http://www.interbrand.com/en/best-global-brands/best-global-brands-methodology/Overview.aspx>>
- BrandZ Top 100 Most Valuable Global Brands*. 2011. MillwardBrown (8 August 2012) <[http://www.millwardbrown.com/BrandZ/Top\\_100\\_Global\\_Brands/Methodology.aspx](http://www.millwardbrown.com/BrandZ/Top_100_Global_Brands/Methodology.aspx)>.
- Chatzkel, J. (2002). *Intellectual Capital*. Oxford: Capstone Publishing.
- Chu, S. and H. T. Keh (2006). Brand value creation: Analysis of the Interbrand-Business Week brand value rankings. *Marketing Letters*, 17, 323–331.

## CREATING THE VALUE OF GLOBAL BRANDS IN THE LIGHT OF THE ANALYSIS OF THE "BEST GLOBAL BRANDS" RANKING

---

- Duliniec, E. (2004). *Marketing międzynarodowy*. Warszawa: Polskie Wydawnictwo Ekonomiczne.
- Fill, Ch. (2005). *Marketing Communications. Engagement, Strategies and Proactice*. Harlow: Prentice Hall.
- Hollensen, S. (2011). *Global Marketing. A Decision-Oriented Approach*. Harlow: Prentice Hall.
- Moeller, L. H. and E. C. Landry (2009). *The Four Pillars of Profit-Driven Marketing. How to Maximize Creativity, Accountability, and ROI*. New York: McGraw-Hill.
- Oczkowska, R. (2008). Produkt w marketing międzynarodowym. In: *Marketing międzynarodowy. Zarys problematyki* (Wiktor, J. W. et al.), Warszawa: Polskie Wydawnictwo Ekonomiczne.
- Reports – BrandZ Top 100 Global Brands. 2011. WPP (30 July 2012) <[http://www.wpp.com/NR/rdonlyres/CC79CED7-AEC2-4AFE-9286-AE548A193F5F/0/WPP\\_BrandZ\\_2011.pdf](http://www.wpp.com/NR/rdonlyres/CC79CED7-AEC2-4AFE-9286-AE548A193F5F/0/WPP_BrandZ_2011.pdf)>.
- Top 100 Brand Ranking – Brand Corporations Worldwide. 2011. Eurobrand (1 August 2012) <<http://www.iconnet.com/medialib/file/eurobrand2011-BRAND-RANKING-Brand-CorporationsTop-100worldwide2011.pdf>>.
- Webster, F. E. (2002). *Market-Driven Management. How to Define, Develop, and Deliver Customer Value*. Hoboken: John Wiley & Sons.



# SERBIAN CONSUMER ACCEPTANCE OF FUNCTIONAL FOODS: SOCIODEMOGRAPHIC AND ATTITUDINAL DETERMINANTS

Jelena Filipović<sup>1</sup>  
Žaklina Stojanović<sup>2</sup>

**Abstract:** *This study aimed to investigate determinants of acceptance of functional food in Serbia and to analyze to what extent these factors affected individuals' consumption of food with health claims. The findings indicate that individuals' education, standard of the household and level of knowledge on products with health claims and perception of some products attributes affect the frequency of functional food consumption. Functional food consumers in Serbia differ from their global counterparts relative to their age, gender, presence of children in household and appraisal of healthiness of functional food. It is recommended that companies should provide consumers with more information on functional food and attempt to diminish the relevance of price through other product's attributes. Since this paper presents the first national assessment of factors that influence functional food consumption in Serbia it will be a valuable benchmark for future studies in the field.*

**Keywords:** *functional food, Serbia, cluster analysis, health claims consumption*

## Introduction

In the last decades market and academic research have reported a raising awareness and interest of consumers in health matters and functional foods in general (Urala and Ldhteenmdki, 2004; Ares and Gambaro, 2007). Several factors could be acknowledged as influencing agents for this trend: recognition of the role of the food in the preservation of health (Krystallis et al, 2008), increase in life expectancy and increasing cost of healthcare (Menrad, 2003). Even though the lack of an official definition of the functional food complicate and limit to some extent monitoring of functional food markets, there are clear evidence that this market has been in the rise in the previous period and it is expected that this trend will continue in the future also. This market was estimated to be \$47.6 billion, whereas the United States were the largest market segment, followed by Europe and Japan (Sloan, 2002). It is projected that the market of functional food will exceed \$130 billion by the year of 2015 (Functional Foods and Drinks: A Global Strategic Business Report). The same report argued that developing regions would be the prime growth engines, especially highlighting East Europe, Asia-Pacific, Latin America and Middle East. This is in line with Sibbel's (2007) assertion that functional foods are commercially relevant in many countries globally.

In spite of this, it could be noted that there is a vast number of studies that tackled functional food market in developed countries (U.S. and EU mainly), while consumer behavior on this matter remained understudied in emerging markets (van Trijp and van der Lans, 2007; Verbeke et al., 2009; Dmitrovic et al., 2009). Several scholars (Frewer et al., 2003; Milosevic et al., 2009) called for attention in reference to this observation, emphasizing that consumer behavior related to functional food varied considerably cross-culturally, with regard to the diversity of specific socio-cultural environments. According to these authors European market is heterogeneous in terms of acceptance of functional food, appraisal of its characteristics and appreciation of different kinds of functional food and nutritive claims. Therefore, it can be concluded that it is necessary to conduct more research on this matter in developing countries and, thus help better understanding of functional food consumption patterns and market potentials in those regions.

---

<sup>1</sup> Faculty of Economics, University of Belgrade, jfilipovic@ekof.bg.ac.rs

<sup>2</sup> Faculty of Economics, University of Belgrade

## SERBIAN CONSUMER ACCEPTANCE OF FUNCTIONAL FOODS: SOCIODEMOGRAPHIC AND ATTITUDINAL DETERMINANTS

---

One of the widely accepted definitions (Diplock et al., 1999) describes functional food as a food that “affects beneficially one or more target functions of the body, beyond adequate nutritional effects, in a way that is relevant to either an improved state of health and well-being and/or reduction of risk of disease”. In the more simple manner, it could be alleged that functional foods are those which can promote health and diminish the risk of illness (Christidis et al., 2011). Hence, European Union legislation (Regulation (EC) No 1924/2006 of the European Parliament and of the Council of 20 December 2006 on nutrition and health claims made on foods) approves two types to be designated on the foodstuffs: nutrition claims and health claims (HC), whereas the latter are used to mark functional foods.

Elements that affect food choice are generally considered to be: the consumers, the food and the environmental and economic issues. Concerning the consumers, usually two groups of attributes are taken into account – their socio-demographic characteristics and their attitudes and motivations to use functional foods. In the sphere of the food, beside its sensory characteristics, the type of the health claim made on the package and the kind of the foods that is carrier are acknowledged also to be important in food selection and acceptance.

It can be argued that of numerous socio-demographic characteristics that have been examined in broad range of studies undertaken on the subject of functional food consumption, just few of them proved to be significant. Nevertheless, research consistently point out that socio-demographic features have certain power to explain differences in acceptability and intention to use functional food (Verbeke, 2005; Ares and Gambaro, 2007).

There is general consensus with respect to the gender of functional food’s buyers – females demonstrate stronger purchase interest towards this kind of food (Childs, 1997; Poulsen, 1999). This outcome is quite salient, provided that females are persons who are responsible for food purchasing in the households. Moreover, functional food users in Europe are often more educated and of higher economic status (Hilliam, 1996; Anttolainen et al., 2001). However, in the domain of consumers’ age there cannot be find such unanimity of opinions and findings. According to Poulsen (1999) and Urala (2005), elderly (older than 55 years) show more intention to buy functional food, which is adverse to the findings of Childs (1997). Another important socio-demographic attribute pertains to the presence of children in household (Xu and Wu, 2008; Verbeke et al., 2009). This finding may be explained in the way that families with children potentially have higher risk aversion, while also seek for fortification in their foods.

In the recent years, lifestyle factors appear to gain in the relevance for unfolding consumers’ food selections. It is deemed that if person lives a healthy lifestyle, that will reflect to her/his food consumption (Villegas et al., 2008), while functional food can provide consumers with a modern way of leading a healthier life without changing their eating habits (Chen, 2011). Studies (Urala, 2005; Krystallis et al., 2008) consistently allege that one of the crucial motives for consumers to use functional food is the preservation of good health status and that one’s health condition and the type of a product’s health claim are highly correlated (van Kleef et al, 2005) with his/her acceptance of a certain functional food product. With regard to the HC, even though they are perceived to be useful (William, 2005), consumers are usually skeptical towards their trustworthiness (Verbeke et al., 2009). It should be noted, that knowledge of food and food ingredients contribute positively to the functional food consumption (Christidis et al., 2011) and that more informed (i.e. knowledgeable) consumers understand better (Grunert et al., 2011) benefits that they could gain from the balanced diet. Indeed, as Sun (2008) concluded, individuals’ perception of their health status, their health concerns and nutritional knowledge would affect the formation of their healthy eating attitudes, and consequently, their habits related to functional food usage.

Furthermore, psychological factors determine to the very high extent what foods individual eats. Of these factors, the most prominent ones related to making food choice are: food preferences, food likes and dislikes and response to sensory attributes (Asp, 1999), which correspond to the attitudes.

Attitudes can be defined “as a psychological tendency that is expressed by evaluating a particular entity with some degree of favour or disfavour” (Urala and Ldhteenmdki, 2004). In other terms, “attitude is the sum of experiences and information about a product (cognition), which evokes positive or negative feelings towards it (affection) and drives the tendency to behave in a certain way (motivation to buy and eat it)” (Behrens et al., 2007).

With respect to the functional food consumers’ attitudes are mostly focused on the healthiness, taste, convenience of use (Gray et al., 2003; Urala and Ldhteenmdki, 2007) and price. It is generally considered and established that belief in the health benefits of functional foods determined positively acceptance of this kind of food (Verbeke, 2005). Nonetheless, the way in which HC are being presented have very low impact on perceived overall healthiness and consumer appeal (van Trijp and van der Lans, 2007), which is in line with consumers’ expressed skepticism towards HC. In addition, consumers are not willing to compromise taste for eventual health benefits (Gray et al., 2003; Ares et al., 2008), implying that sensory attributes are the essential in determining ultimate food choice. Correspondingly, certain findings (Asp, 1999) suggest that liked foods are those that are familiar and considered pleasant, while disliked foods are rejected either because they are perceived to be unpleasant or they have never been tasted. Concerning the perception of the price of the functional food, rather equivocal findings are encountered in the subject literature (Krystallis et al., 2008; Verbeke et al., 2009). One rational explanation could be the one proposed by Verbeke et al. (2009), citing that consumers may express the price argument in order to rationalize their reserves against functional foods, even though underlying reasons for this rejection is rather related to non-economic considerations.

Stemming from the subject literature and observed research gaps, this study aimed to explore determinants of acceptance of functional food in Serbia and to analyze to what extent these factors affected individuals’ consumption of food with HC.

## **Research methodology**

### ***Participants and sampling***

The questionnaire was administered to 505 respondents in Serbia, while stratified three-stage random sampling method was adopted, in order to ensure nationally representative samples. Primary sampling units were polling station territories, which encompassed about 200 households defined by street names. In the second stage specific households were chosen; and in the third phase sampling units were actual respondents. In order to optimize the sample plan and reduce sampling error, the stratification was done by region and type of settlement. The survey was undertaken in September 2010 and data collection was organized through face-to-face interviews at respondents’ homes. Respondents’ personal characteristics are provided in the Table 1.

### ***Instrument***

The questionnaire was developed in order to investigate broad range of research questions, regarding motives on food choice and consumption, attitudes, knowledge and social norms related to four product categories (fruit, traditional food, organic food and products with HC). In the last section of the survey, participant’s socio-demographic data were gathered. The questionnaire was developed in English, translated in Serbian and then back-translated to English. The comprehensibility of the questionnaire was investigated by pilot study that comprised 60 respondents.

**SERBIAN CONSUMER ACCEPTANCE OF FUNCTIONAL FOODS: SOCIODEMOGRAPHIC AND ATTITUDINAL DETERMINANTS**

**Table 1: Statistical features of respondents**

<b>Variant</b>	<b>Sample population</b>	<b>Percentage</b>
Gender		
Male	197	39.0
Female	308	61.0
Age		
18-30	115	22.8
31-50	153	30.3
51-65	143	28.3
66 or above	94	18.6
Education		
Unfinished elementary school	117	23.2
Finished elementary school	19	3.8
Finished secondary	276	54.7
College or university degree	93	18.4
Standard of household		
Bad	121	24.0
Moderate	253	50.1
Good	131	25.9
Children in household		
Yes	140	27.7
No	365	72.3
State of health		
Very bad	10	2.0
Bad	48	9.5
Moderate	156	30.9
Good	201	39.8
Very good	90	17.8
Body Mass Index		
Underweight (<18.4)	14	2.8
Normal (18.5 to 24.9)	251	49.7
Overweight (25 to 29.9)	189	37.4
Obese (>= 30)	51	10.1
Level of information		
Not informed at all	61	12.1
Very poorly informed	106	21.0
Moderately informed	234	46.3
Very well informed	78	15.4
Fully informed	26	5.1
HC on products labels are useful		
Agree	372	73.7
Disagree	133	26.3

Given the research subject of this paper, only relevant part of the questionnaire, which concerns products with HC, will be described. In the introductory part of the survey it was explained to the

respondents what it was meant by the term “products with HC” and some examples were given. We considered this to be important since some previous studies (van Trijp and van der Lans, 2007; Christidis et al., 2011) identified that consumers in various European countries often do not know the term of “functional food” or related concepts (e.g. health claims). The formulation in the questionnaire was as following: “Health claims that we see on product packages are claims that link a nutrient to a normal functioning of the body or a specific disease. An example of a health claim – *High in calcium, Calcium helps build strong bones. Adequate calcium throughout life, as part of well-balanced diet, may reduce risk of the osteoporosis*”. Some pictures with products with HC (e.g. probiotic yoghurts, milk enriched with vitamins) were provided also, ascertaining respondent’s better apprehension of this kind of the food.

Self-reported assessment was applied in responses to questions about: a) frequency of consumption, b) respondent’s level of information on food with HC, c) whether participant perceives HC made on product labels to be useful, d) his/her state of health, e) standard of his/her household. For evaluation of frequency of consumption 10-points scale was used, including subsequent items: more than 2 times a day, twice a day, once a day, once in 2-3 days, once a week, 2-3 times a month, once a month, several times a year, once a year or less, never. Attitudes were measured by 7-point semantic differential scales, ranging from -3 to 3, including 0, which represented neutral score. Answer modalities for the other questions can be observed in the Table 1.

### **Data analysis**

Several statistical techniques were employed for investigating data: regression, cluster analysis, independent-samples t test and chi-square. Multiple linear regression was run aiming to establish whether certain respondent’s features affect his/her frequency of purchasing of products with HC. These results are accompanied with descriptive statistics, which should help better understanding of obtained data in regression analysis.

In the second phase of the examination, hierarchical cluster analysis was performed. Respondents were segmented into the clusters based on their attitudes towards food with HC (i.e., their expressed level of evaluation of the following food attributes – bad/good; unpleasant/pleasant; unhealthy/healthy; inconvenient for consumption/convenient for consumption; tasteless/tasty; cheap/expensive). Ward’s aggregation method and Euclidian distances were applied.

Clusters profiling through identifying distinctive characteristics of each of the clusters was obtained by chi-square test and independent-samples t test. In the case of categorical variables (e.g., gender, presence of the children in the household, etc.) chi-square test at the significance level of 5% was performed, while in the case of metric variables (e.g., frequency of consumption of products with HC and respondent’s knowledge about products with HC), independent-samples t test was considered to be suitable, again at the significance level of 5%. All statistical procedures were conducted using PASW Statistics 18 for Windows (SPSS Inc, Chicago, IL, 2009).

### **Results and discussion**

In order to assess the influencing factors on the frequency of consumption of products with HC, a multiple linear regression was performed. The complete list of the variables included in the model is presented in the Table 2. Five kinds of explanatory factors are considered: socio-demographic (e.g., gender, age, education, etc.), physiological (overall state of health and body mass index), level of information (knowledge) of products with HC, skepticism of products with HC and attitudes towards the products with HC (e.g., whether respondents perceive this kind of products to be good, healthy, tasty, etc.). The regression model explained 44.4% of the variance of the experimental data.

**SERBIAN CONSUMER ACCEPTANCE OF FUNCTIONAL FOODS: SOCIODEMOGRAPHIC AND ATTITUDINAL DETERMINANTS**

**Table 2: Descriptive statistics**

<b>Variable</b>	<b>Mean</b>	<b>Std. Deviation</b>
How often they consume products with HC	5.88	2.542
Gender	1.61	0.488
Age	2.43	1.037
Education	2.68	1.025
Standard of the household	2.02	0.707
Children in household	0.28	0.448
Overall current state of health	3.62	0.950
BMI	3.55	0.711
Level of information	2.81	1.009
HC on product labels are useful	1.26	0.441
Bad/Good	2.15	1.254
Unpleasant/Pleasant	2.07	1.241
Unhealthy/Healthy	2.19	1.227
Inconvenient for consumption/Convenient for consumption	2.11	1.256
Tasteless/Tasty	1.96	1.338
Cheap /Expensive	2.01	1.336

The results of the regression analysis are reported in the Table 3. Among socio-demographic explanatory variables affecting consumer's frequency of consumption of products with HC, education and economic standard of the household had significant influence. Consumers with higher educational level and higher income would buy products with HC more often, which supports some previously published data (Hilliam, 1996; Verbeke, 2005).

Physiological factors, overall state of health and body mass index, have not proved to be statistically significant in predicting consumers' frequency of buying HC products. Reason for this can be found in the fact that respondents estimated their generic health status, not concentrating on some particular health issue that they could be concerned of, while some preceding studies denoted that functional food use was associated with specific health problems (Verbeke et al., 2009), and thus, specific functional food types, as well as with the care about calories intake (Sun, 2008).

As expected, respondents who considered being better informed about this kind of food, tended to buy products with HC more often. These outcomes corroborate conclusions drawn by Grunert et al. (2011) and by Sun (2008). Interestingly, consumers' skepticism of products with HC – consumers who agreed with the statement that HC made on product labels were useful in helping her/him to decide which product to consume, have not appeared to affect the frequency of consumption of products with HC.

Three out of six investigated attitudes toward the products with HC are found to have significant influence on frequency of consumption of HC products. Results show that the consumers' perception of the goodness and taste of some product to the higher extent lead to more frequent consumption of that product. On the other hand, if a product is perceived to be more expensive, consumers are less likely to buy it.

**Table 3: Regression results for frequency of consumption**

Variable	Beta
Gender	-0.011
Age	0.022
Education	-0.105**
Standard of the household	-0.108**
Children in household	0.036
Overall current state of health	0.063
BMI	0.022
Level of information	-0.397**
HC on product labels are useful	-0.028
Bad/Good	-0.238**
Unpleasant/Pleasant	-0.038
Unhealthy/Healthy	0.063
Inconvenient for consumption/Convenient for consumption	0.002
Tasteless/Tasty	-0.188**
Cheap /Expensive	0.152**

Asterisks indicate that estimated coefficients are significant at \*5% or \*\*1% level of confidence

Hierarchical cluster analysis was run in order to establish whether consumers with different attitudes towards functional food differ in their consumption patterns concerning that kind of food. This criterion for clusters segmentation is in line with previous studies stating that the beliefs and attitudes outweigh the impact of socio-demographic determinants on functional food acceptance (Verbeke, 2005; Christidis et al., 2011; Grunert et al., 2011). Two clusters are identified: Cluster 1, including 375 respondents and Cluster 2, composed of 130 participants. Statistically significant differences between these two clusters are found in four cases, as reported in Table 4.

**Table 4: Items of the attitudinal questionnaire and average scores for each of the three identified clusters**

Attitude scale items (By your opinion products with HC are...)	Cluster 1 – HC Enthusiasts (n=375)		Cluster 2 – HC Opponents (n=130)		Cluster 1 x Cluster 2
	Mean	Std. Deviation	Mean	Std. Deviation	
Bad/Good	2.74	0.512	0.45	1.201	*
Unpleasant/Pleasant	2.63	0.712	0.45	1.005	*
Unhealthy/Healthy	2.73	0.636	0.64	1.194	*
Inconvenient for consumption/ Convenient for consumption	2.67	0.673	0.50	1.156	*
Tasteless/Tasty	2.50	0.936	0.42	1.113	*
Cheap /Expensive	2.29	1.162	1.20	1.470	*

Asterisks indicate that average scores for clusters 1 and 2 are significantly different at 5% level of confidence according to t test

## SERBIAN CONSUMER ACCEPTANCE OF FUNCTIONAL FOODS: SOCIODEMOGRAPHIC AND ATTITUDINAL DETERMINANTS

---

The majority of respondents were classified in the Cluster 1 and they exhibited very positive attitudes towards the products with HC – therefore this cluster was named HC Enthusiasts. However, they perceived functional food to be quite expensive ( $M=2.29$ ) in contrast to participants of the Cluster 2 ( $M=1.20$ ). Opposite to them, the participants of the Cluster 2, named HC Opponents, showed rather unfavourable attitudes towards functional food, considering it to be not very pleasant ( $M=0.45$ ), nor tasty ( $M=0.42$ ).

In clusters profiling several factors were distinguished as significant, according to chi-square statistics – education, age (at 10% level of confidence), respondent's state of health and respondent's level of information about food with HC. Unexpectedly, gender, age, standard of the household and person's opinion on whether HC on product labels help product choice for consumption have not significantly affected the segmentation. The HC Enthusiasts are younger, more educated and assess that their health condition to be very good ( $M=2.51$ ). Adversely, HC Opponents were less educated, perceived their health status to be lower and were older than their counterparts from Cluster 1. The significance of the enumerated factors in the differentiation of various segments of consumers of the functional food have been recognized in previous literature (Anttolainen et al., 2001; Xu and Wu, 2008; Verbeke et al., 2009).

Highly significant differences were found among clusters for the respondent's appraisal of the how much he/she was informed about products with HC and frequency of consumption of the functional food. Results of the independent samples t-test revealed that HC Opponents thought to be less informed about products with HC than the HC Enthusiasts, which is confirmed by descriptive statistics also ( $M1=3.01$ ,  $M2=2.23$ ; means are given respectively for Cluster 1 and Cluster 2). Moreover, both clusters significantly varied with regard to the frequency of consumption of products with HC. In this case, inspection of the clusters' means could be also useful, in terms that it exhibits that HC Enthusiasts buy functional food often ( $M=5.32$ , once a week on the average), while HC Opponents do the same very rarely ( $M=7.50$ , several times a year). These findings suggest that consumers' attitudes towards food characteristics have impact on the frequency of consumption of functional foods, which is underpinned by prior subject research (Gray et al., 2003; Grunert et al., 2011).

### Conclusions

This paper presents the first cross-national assessment of factors that influence functional food consumption in Serbia. Provided that estimates indicate raising significance of Eastern European market of foods with HC, gaining an insight and better knowledge of local consumers on this matter is of the crucial importance. This study revealed manifold differences between Serbian consumers of functional foods and their global counterparts.

Several variables established as highly relevant in previous subject research failed to demonstrate their significance in determining differences in level of consumption of products with HC in our case. Above all, these variables pertain to gender, presence of children in household and perceived state of health. The majority of previous studies ascertained that these three factors highly affect individuals' consumption of products with HC, however our regression model did not confirm the same. In addition, perceived healthiness of food, pleasure and convenience of consumption have not appeared to influence frequency of consumption, which is opposite to findings of some prior research (Urala and Ldhtenmdki, 2007; Villegas et al., 2008; Chen, 2011). It may be concluded that taste and price represent prevailing elements in determining how often food with HC would be used, which has already been confirmed to be true for foods in general.

Cluster analysis indicated that companies should put more efforts in informing consumers about functional food and HC. Provided that respondents of the Cluster 2 (HC Opponents) demonstrated



unfavourable attitudes toward functional food, but on the other hand they expressed to be poorly informed about products with HC, marketers could consider providing more information on this matter to them in order to influence their more positive attitudes in the future. Individuals recognized as HC Enthusiasts should be more investigated in terms of lifestyle in order to achieve their effective marketing targeting, since they represent driving force and the most lucrative segment of Serbian functional foods market. Moreover, with regard to the fact that they are very sensitive to the price and perceive functional food to be expensive, companies should try to communicate better to which extent prices of products with HC differ comparing to prices of conventional products, and what kind of benefits they provide their consumers with for these premium prices.

Finally, some limitations should be mentioned also. Firstly, self-reported measures as the indicators of consumption frequency and level of information on products with HC were applied, which could lead to fairly inaccurate assessments. Secondly, since face-to-face interviews were conducted, that might imply sensitivity to socially desirable answers. In order to improve further studies in this field, utilization of diary method could be more reliable in investigating consumption and level of knowledge on functional food.

### Acknowledgements

The research leading to these results has received funding from the European Union's Seventh Framework Programme (FP7 2007-2013) under grant agreement 212 579, co-ordinated by Dr. Dominique Barjolle. The financing of this work by European Commission is gratefully acknowledged.

### References

- Anttolainen, M. et al. (2001). Characteristics of users and nonusers of plant stanol ester margarine in Finland: An approach to study functional foods. *Journal of the American Dietetic Association*, 101, 1365–1368.
- Ares, G. and A. Gambaro (2007). Influence of gender, age and motives underlying food choice on perceived healthiness and willingness to try functional foods. *Appetite*, 49, 148–158.
- Ares, G., A. Giménez and A. Gambaro, (2008). Does information about the source of functional ingredients influence consumer perception of functional milk desserts?. *Journal of the Science of Food and Agriculture*, 88, 2061-2068.
- Asp, E.H. (1999). Factors affecting food decisions made by individual consumers. *Food Policy*, 24, 287–294.
- Behrens, J.H., R.J.B. Heinemann and U.M. Lanfer-Marquez (2007). Parboiled rice, A study about attitude, consumer liking and consumption in Sao Paulo, Brazil. *Journal of the Science of Food and Agriculture*, 87, 992-999.
- Chen, M.F. (2011). The joint moderating effect of health consciousness and healthy lifestyle on consumers' willingness to use functional foods in Taiwan. *Appetite*, 57, 253-262.
- Chen, M.F. (2011). The mediating role of subjective health complaints on willingness to use selected functional foods. *Food Quality and Preference*, 22, 110-118.
- Childs, N.M. (1997). Functional foods and the food industry, consumer, economic and product development issues. *Journal of Nutraceuticals, Functional and Medical Foods*, 1, 25–43.
- Christidis, N. et al. (2011). A cross sectional study of consumer awareness of functional foods in Thessaloniki, Greece. *Nutrition & Food Science*, 41,165–174.
- Diplock, A.T. et al. (1999). Scientific concepts of functional foods in Europe, Consensus Document. *British Journal of Nutrition*, 81, 1–27.

## SERBIAN CONSUMER ACCEPTANCE OF FUNCTIONAL FOODS: SOCIODEMOGRAPHIC AND ATTITUDINAL DETERMINANTS

---

- Dmitrović, T., I. Vida and J. Reardon (2009). Purchase behavior in favor of domestic products in the West Balkans. *International Business Review*, 18, 523–535.
- Frewer, L., J. Scholderer and N. Lambert (2003). Consumer acceptance of functional foods: issue for the future. *British Food Journal*, 105, 714–731.
- Functional Foods and Drinks, A Global Strategic Business Report, [http://www.prweb.com/releases/functional\\_foods/functional\\_drinks/prweb4688424.htm](http://www.prweb.com/releases/functional_foods/functional_drinks/prweb4688424.htm), [Accessed, 16 May 2012]
- Gray, J., G. Armstrong and H. Farley (2003). Opportunities and constraints in the functional food market. *Nutrition & Food Science*, 33, 213–218.
- Grunert, K.G., J. Scholderer and M. Rogeaux (2011). Determinants of consumer understanding of health claims. *Appetite*, 56, 269–277.
- Hilliam, M. (1996). Functional foods: The Western consumer viewpoint. *Nutrition Research*, 54, S189–S194.
- Krystallis, A., G. Maglaras and S. Mamalis (2008). Motivations and cognitive structures of consumers in their purchasing of functional foods. *Food Quality and Preference*, 19, 525–538.
- Menrad, K. (2003). Market and marketing of functional food in Europe. *Journal of Food Engineering*, 56, 181–188.
- Milošević, J. et al. (2012). Understanding the motives for food choice in Western Balkan Countries. *Appetite*, 58, 205–214.
- Poulsen, J.B. (1999). *Danish consumers' attitudes towards functional foods*. Working Paper 62. Aarhus School of Business, MAPP, Aarhus.
- Regulation (EC) No 1924/2006 of the European Parliament and of the Council of 20 December 2006 on nutrition and health claims made on foods, <http://eur-lex.europa.eu/LexUriServ/LexUriServ.do?uri=OJ:L:2007:012:0003:0018:EN:PDF>, [Accessed: 15 May 2012]
- Sibbel, A. (2007). The sustainability of functional foods. *Social Science and Medicine*, 64, 554–561.
- Sloan, E. (2002). The top 10 functional food trends. The next generation. *Food Technology*, 56, 32–57.
- Sun, Y.H.C. (2008). Health concern, food choice motives, and attitudes toward healthy eating: The mediating role of food choice motives. *Appetite*, 51, 42–49.
- Urala, N., *Functional foods in Finland, Consumers' views, attitudes and willingness to use*. <http://www.vtt.fi/inf/pdf/publications/2005/P581.pdf>, [Accessed, 8 May 2012]
- Urala, N. and L. Lähteenmäki (2004). Attitudes behind consumers' willingness to use functional foods. *Food Quality and Preference*, 15, 793–803.
- Urala, N. and L. Lahteenmaki (2007). Consumers' changing attitudes towards functional foods. *Food Quality and Preference*, 18, 1–12.
- van Kleef, E., H.C.M. van Trijp and P. Luning (2005). Functional foods, health claim-food product compatibility and the impact of health claim framing on consumer evaluation. *Appetite*, 44, 299–308.
- van Trijp, H.C.M. and I.A. van der Lans (2007). Consumer perceptions of nutrition and health claims. *Appetite*, 48, 305–324.
- Verbeke, W. (2005). Consumer acceptance of functional foods: sociodemographic, cognitive and attitudinal determinants. *Food Quality and Preference*, 16, 45–57.
- Verbeke, W., J. Scholderer and L. Lahteenmaki (2009). Consumer appeal of nutrition and health claims in three existing product concepts. *Appetite*, 52, 684–692.
- Villegas, B., I. Carbonell and E. Costell (2008). Effects of product information and consumer attitudes on responses to milk and soybean vanilla beverages. *Journal of the Science of Food and Agriculture*, 88, 2426–2434.
- William, P. (2005). Consumer understanding and use of health claims for foods. *Nutrition Research*, 63, 256–64.
- Xu, L. and L. Wu (2008). Food safety and consumer willingness to pay for certified traceable food in China. *Journal of the Science of Food and Agriculture*, 90, 1368–1373.

# ETHICAL CONSUMER ACTION IN ACHIEVING SOCIAL AND POLITICAL GOALS

Dražen Marić<sup>1</sup>

**Abstract:** *The origins of many of the most inspiring examples of ethical action by consumers date back to the 1970s, when the first fair trade initiatives started. Ethical banking emerged with the first social banks starting up in the USA and Europe. From these beginnings, there are many markets in which ethical consumers have had significant effect – from animal testing and lead in petrol through to organics and animal welfare in farming. Ethical consumerism has grown to be a force to appreciate. There is no doubt, however, that the field has to grow up again, if it is to find opportunities for activism that live up to the wild facts of environmental deterioration and global injustice. A new valley of technology has opened up which offers ways to connect people across the long chains of economic exchange. Ethical consumer action in achieving social and political goals such as consumer boycotts or/and positive buying, has become one of the major forces that creates contemporary business environment, moreover, has significant impact on business success or failure.*

**Keywords:** *consumerism, ethics, consumer action, boycotts, positive buying*

## Introduction

“I shop – therefore I am.” (New millennium Descartes)  
Helene Cherrier & Jeff Murray

It can be asserted that humanity is currently in a stage of the most intensive technological advancement ever, which, under the influence of economic and political changes, alters the social environment of modern consumers. Individuals' lifestyles and their way of living, which can be identified through consumption patterns, adapt to these changes, while influencing them at the same time. The conclusion is very clear – not only does present consumer behaviour influence their current quality of living, but also the quality of living of succeeding generations, which is equally important.

If we consider consumption as a general purpose of the production of goods and services within a society, it is necessary to further consider consumption as a source of most problems in the natural environment, and finally, as a source of all inequality and injustice within humanity.

The domain of marketing ethics, where the term *social responsibility* is most frequently used, draws growing attention, not just of theoreticians and professionals, but also of all relevant parties and institutions which facilitate the functioning of a society. This, however, is still an insufficiently explored domain, characterized by many controversies and disagreements. This is particularly characteristic of the problem regarding discovering and thoroughly explaining mechanisms between (un)ethical marketing practices and consumer behaviour, and vice versa.

Modern consumers build their personal identities and lifestyles increasingly through their personal consumption. Consumers' decisions and their evaluations of total values of products are predominantly influenced by symbolical values and values reflecting individuals' maturity and their sense of responsibility for the environment. The modern 'newborn' consumers epitomize a new type of consumer that try to change their society for the better by altering their own behaviour and accentuating ethical demands.

---

<sup>1</sup> Faculty of Economics Subotica, University of Novi Sad, drdrazen75@yahoo.com

The aim of this article is to present complex phenomena of ethical consumption and ethical consumer behaviour, along with different kinds of consumer activism used to accomplish social and political goals. The fundamental premise of this article is that modern consumers are becoming increasingly aware of their ability to improve the society they live in through their behaviour and purchase decisions, and therefore behave more and more pursuant to that.

### **Ethical consumption era**

Most authors that deal with marketing ethics and social responsibility based their research on the doctrine first proposed by Philip Kotler, who is considered to be a founder social marketing movement. Given the fact that what consumers' desire may not necessarily be good for them (e.g. tobacco), Kotler's followers stress the threat of creating a happy customer in the short term, for both consumer and society may suffer as a direct result of such actions in the long run (Carrigan & Attala, 2001).

Therefore, contemporary consumer behaviour and consumption cannot be observed as a simple process based on rational behaviour and decision criteria that require optimal information, time, and a rational choice. Quite the opposite, purchase decision and the subsequent consumption are predominantly irrational processes that occur within a consumer's consciousness and are directed by emotions mood, time pressure, perceptions, tastes, beliefs, attitudes, opinions, but also by expectations of the society and limited natural resources. Socially responsible marketing must respond to these demands addressed to products and services that possess a clear ethical dimension.

Research into socially responsible marketing and ethics in consumer behaviour is further burdened with problems concerning divergence in the use and meanings of terms such as 'ethical behaviour', 'ethical shopping' and 'ethical consumption'; most researchers, however, agree that the term 'ethical consumer behaviour' is the most extensive one, and that it encompasses the following two. Ethical consumer behaviour can be interpreted as "decision-making, purchases and other consumption experiences that are affected by the consumer's ethical concerns" (Bray, Johns & Kilburn, 2011, p, 597). Analogous to this definition, 'ethical consumption' can be understood as "the purchase and use of a products and services chosen freely by an individual consumer that concern a certain ethical issue, such as human rights, labour conditions, animal well-being, environment, etc." (De Pelsmacker, Driesen & Rayp, 2005, p. 363). Some forms of ethical consumption contribute to the improvement of natural environment, while others are focused on benefits for people. An additional problem emerges from the absence of consensus among authors on the answer to the question: 'Satisfaction of which stakeholders' interests should be a priority within a society?'

Examining literature from this area, one can identify two fundamental views of ethical consumption, which, one might say, are derived from the everlasting debate between the consequentialists and deontologists. This is related to differences between the conservative outlook on ethical consumption – one that finds that consumers must adhere to clearly defined ethical norms if they wish to behave and consume ethically, and the liberal outlook – one that considers ethical consumption a free choice, based on beliefs, values and sense of responsibility, which are different for every individual.

Ethical consumption encompasses a wide array of activities – from ethical investments, i.e. ethically motivated purchases of shares and securities, to purchases of 'fair-trade' products and organized consumer boycotts. Despite being very complex and diverse, ethical consumption, can be classified into five groups shown in Table 1.

**Table 1: Types of ethical consumption**

<b>Type:</b>	<b>Product-oriented purchasing</b>	<b>Company-oriented purchasing</b>
<b>BOYCOTTS</b>	Aerosols, Timber from unsustainable forestry	Philip Morris, Nike, Nestle
<b>POSITIVE BUYING</b>	Fair-Trade mark, Blue Angel Eco label, Green Apple	Body Shop against animal testing
<b>FULLY SCREENED-ethical ratings across whole product area</b>	Green Consumers Guide	Ethical screening of investments
<b>RELATIONSHIP PURCHASING-consumers seek to educate sellers about their ethical needs</b>	Community Supported Agriculture USA, UK	Individual consumer building relationship with shopkeepers
<b>ANTICONSUMERISM / SUSTAINABLE CONSUMERISM</b>	Avoiding unsustainable products (cars)	Adbusters

Source: Harrison R., Newholm T., Shaw D., *THE ETHICAL CONSUMER*, London: Sage Publications Ltd., 2005, pg 3.

Through social and ecological requirements, ethical consumption features as a new kind of connection between a consumers and the outside world. The beginning of the 21<sup>st</sup> century raised the already growing interest in ethical consumer behaviour and ethical consumption, along with their and their importance, to a superior level. This was facilitated by advancements in technology, information and communication, which made it possible to clearly exhibit and rank all individual and institutional activities in terms of ethical and responsible behaviour.

In making a purchase decision, modern ethical consumers are not primarily guided by personal benefits, but extend their purchase criteria with certain issues concerning general interest.

### **Consumer empowerment**

Even though it can also be partly ascribed to developing countries, highly developed countries are characterised by the fact that consumers play an increasingly significant role in processes of manufacturing and creating value of products and services; therefore, the basic function of consumption – satisfaction of vital human needs – is moving towards the satisfaction of advanced human needs and accomplishment of goals concerning general welfare. A new consumer culture has been established, in which consumers’ concern for consequences of their purchase choices on the natural environment and society (Shaw, Newholm, Dickinson, 2006) There is also an evident growth in consumers’ commitment to fulfil their purchase decisions not driven by selfish interests, but rather interests of the community they belong to.

A modern consumer is a sophisticated consumer (Carrigan & Attala, 2001), which means that they are very well informed, have a higher and better quality education, and are aware of their consumer rights – rights that they formulate into exact and complex demands they subsequently impose on companies. Consumer sophistication has resulted in new consumption patterns, which are distinct for altered preferences and a growing demand for ethical goods and services, such as experimental consumption and recreational shopping (Žnideršić & Marić, 2007). It is also necessary to highlight the fact that there is a disagreement between a consumer’s sophisticated traits and their sophisticated consumption. The fact that a consumer possesses certain sophisticated traits does not

mean that they will certainly act sophisticatedly in reality. This means that having sufficient knowledge and ability to act ethically is not enough; it is necessary to put this knowledge and ability into use and behave in such way. The modern consumer is a consumer who is extremely active in the market and the society, i.e. somebody who refuses a subordinate role.

The rise in consumer activism was additionally caused and stimulated by the exponential growth in quantity and the increase in availability of information on global challenges of social and economic development. News and reports on unethical conduct of both enterprises and individuals are no longer available only to most persistent activists who advocate protection of consumer and animal rights, natural environment etc. Greater interest of the media in these issues made such information available to everyone. Development of the Internet significantly contributed to all this. The number of consumers actively involved in market activities intended to exert pressure on producers and distributors to adhere to ethical requirements is growing on a daily basis. Evidently, we witness the shift of negotiating leverage from producers to consumers, even though it must be mentioned that consumers are still not in a better position. Powerful public protests, boycotts, along with favouring some (ethical) over other (unethical) companies through purchases, or refraining from purchase, change the traditional market situation and corroborate the intensification of consumer power.

It is necessary to highlight the fact that, despite certain reports on the increase in consumption of ethical products, the share of ethical consumption in overall consumption remains at a rather low level. A situation where actual consumer behaviour differs from their previously stated intentions is referred to as ‘the attitude-behaviour gap’, ‘the intentions-behaviour gap’, or ‘the word-deed gap’ in the literature. (Carrington, Neville & Whitwell, 2010, p. 141). Explanation of the origin of the behaviour gap is based on two considerations (De Pelsmacker, Driesen and Rayp, 2005). The first one states that consumers’ attitudes and perceptions unquestionably determine their intentions and purchase behaviour. Accordingly, a certain number of ethical behaviour models were proposed. The second states that it has been confirmed on numerous occasions that attitudes and statements on consumer intentions represent very unreliable sources for predicting their actual purchases, especially in the domain of social marketing. The latter is an outcome of the so-called ‘consumer dissonance’, which reflects the situation where consumers do not make statements on their behaviour, preferences or intentions the way they really feel, but the way they consider to be socially acceptable and presents themselves as better persons. Despite all, studies clearly indicate that consumers certainly know how to reward or penalize companies that behave unethically, but it is more probable that they will penalize unethical behaviour than reward ethical conduct (Carrigan, Attala, 2001).

Shaw, Newholm and Dickinson (2006) provided an outstandingly comprehensive and often cited outlook on the process of strengthening consumers’ position and their role on the market. They examined this phenomenon through three dimensions:

- Consumption as voting – nowadays, consumers are becoming aware of the fact that they can impact their environment through their purchase decisions in a way almost identical to voting at political elections. The perception of a market as a democratic milieu, where every penny represents a right to vote and each purchase decision represents a vote in the economic elections. Strengthening consumers’ position and their influence implies that, through purchases, they cast a vote for a particular model of production and business in general, and not only for certain features of a final product.
- Consumer sovereignty and the market – if we look upon consumption in the same way as Adam Smith, that is, as a culmination and a goal of all economic activities, then we can perceive the strengthening of consumer sovereignty and as consumers’ ability to choose between a vast number of providers of goods and services, to condition them on which goods and services to offer and the way of producing them. Consumer sovereignty increases with the development of information flows, greater possibility of choice and stronger competition, but decreases with government interventions and income decrease.

- Consumer power in the market – refers to the legitimate consumers’ power to purchase certain products or refrain from such purchase, which may result in growth or decline in revenues of particular companies and industries, which ultimately manifests itself in macroeconomic indicators of the entire economy.

Ethical consumer behaviour and consumers’ awareness of their strengthened position in the market and society can essentially be recognized as a social reaction to the perceived injustice, in the broadest sense of the word. Consumers feel this injustice very emotionally but react to it in a very rational way. More often, they resort to various forms of active social engagement in order to achieve their social and political goals.

### Consumer boycotts and positive buying

When exploring the phenomenon of ethical consumer behaviour as a means of achieving social and economic goals, most authors primarily deal with phenomena such as consumer boycotts and anti-consumption. Claims most frequently used to support the acknowledged notion that consumers are willing to take very serious actions in order to make companies and other institutions to behave in compliance with ethical principles are a result of organized consumer boycotts of large corporations (Shell Oil – decrease in sales of 50% and Nestle - \$40 million loss). Other data may serve as evidence of the increase in the number of consumers who are absolutely willing to be actively engaged in any form of consumer action, even boycotts, over the last five years. Data collected in a study carried out in the United Kingdom suggest that 44% of respondents stated that they had participated in boycotts over the last 12 months. (Carrigan & Attala, 2001, p. 564), while this percentage in Sweden, Canada, USA and Italy is 27.9%, 21.6%, 21.2% and 19.7%, respectively (Hoffmann, 2011, p. 1703). Naturally, different studies specify different figures, but all reveal the same trend – consumers are increasingly assuming the role of the so-called social supervisor of economic and social settings.

Elaboration on ethical consumer behaviour intended for achieving social and political goals initially requires making clear distinction of terms (Hoffmann, 2011, pg. 1703): *consumer boycott* – which is a form of *anti-consumption* – which is further a method of *consumer resistance*. These are very similar terms and many authors are mistaken not to recognize differences between them, but differences are present and important. Anti-consumption always implies desistence of consumption of particular goods or services produced by certain industries. Consumer resistance mostly concerns active and increased consumption of goods and services of particular producers and industries that display convincing ethical attributes and represent a competition to those who lack these attributes. Consumer boycotts most often combine these activities. Galvagno (2011) provided an interesting outlook on differences between anti-consumption and consumer resistance. This is presented in the following table:

**Table 1. Concepts of anti-consumption and consumer resistance**

<b>Anti-consumption as an ATTITUDE</b>	<b>Consumer resistance as BEHAVIOUR</b>
- personal and without intentions to influence others	- an individual has the chance and the power to change something within the society
- restricted to the refrainment of purchase	- completely intentional activity aimed at making a change in the society
- may lead to consumer resistance	- may exist without the attitude that motivates anti-consumption

Source: Galvagno M., *The intellectual structure of the anti-consumption and consumer resistance field: an author co-citation analysis*, *European Journal of Marketing*, Vol. 45, No. 11, 2011, p. 1699.

A significant number of studies of ethical consumer behaviour involve attempts to identify and classify different types of consumers that dominantly exhibit ethical behaviour. Often cited authors, Iyer and Muncy (2009, pg. 161) proposed their matrix of ethical consumer types, based on the object and the goal of anti-consumption. This is presented in the following table:

**Table 2. Types of anti-consumers**

		Goal of anti-consumption	
		<i>Social interest</i>	<i>Personal interest</i>
Object of anti-consumption	<i>Overall consumption</i>	GLOBAL IMPACT CONSUMERS	SIMPLIFIERS
	<i>Specific products. brands, producers, industries</i>	MARKET ACTIVISTS	ANTI-LOYAL CONSUMERS

Source: *Iyer R., Muncy J.A., Purpose and object of anti-consumption, Journal of Business research Vol. 62, 2009, p. 161*

In order to determine and predict amongst which consumers, and in what way, will the effect of these factors manifest on specific ethical behaviour, the same authors conducted further analyses and associated anti-consumption with psychological concepts of assertiveness, self-consciousness and self-actualization of individual consumers.

Upon analyzing studies on behaviour of consumers who were ethically active in consumer boycotts from 1976 to 2009, Hoffmann (2011, pg. 1703) proposed three categories of ethical consumers:

- Triggers – consumers who motivate others to actively engage in consumer boycotts, while they themselves are motivated by some kind of anger and animosity towards particular products, companies, industries, or become engaged as a result of a sincere concern for certain personal or social issues;
- Promoters – encourage other consumers, support them and provide personal example for active engagement in consumer boycotts;
- Inhibitors – represent a group of consumers who rationally supply others with arguments against participating in consumer boycotts. These consumers are motivated by the fear of consequences that can result from engaging in an active boycott, lack of substitute products, satisfaction from the use of a boycotted product, loyalty to a brand or a producer, etc.

The same author emphasizes that a consumer boycott can even be perceived as a new or a renewed product on the market; thus, its success should be observed through the process of diffusion of innovation among different categories of novelty adopters (Hoffmann, 2011).

Boycotts have a long and noble history of contributing to progressive social change, as well as succeeding in their more immediate goals. One of the earliest examples was the boycott in England of sugar produced by slaves. In 1791, after Parliament refused to abolish slavery, thousands of pamphlets were printed encouraging the boycott. Sales of sugar dropped by between a third and a half. By contrast sales of Indian sugar, untainted by slavery, rose tenfold in two years. In an early example of fair trade, shops began selling sugar guaranteed to be have been produced by 'free men'. (retrieved from <http://www.ethicalconsumer.org/boycotts/successfulboycotts.aspx>, July 26, 2012, 13:30).



Research of consumer boycotts must begin with the delineation of their effectiveness and success. Harrison, Newholm & Shaw (2005) believe that effectiveness of a consumer boycott can be observed through a decrease in sales of a boycotted product or a company, while the success of a consumer boycott can be measured by the degree of achievement of political and social goals, which was initially the cause for the boycott. This leads to a conclusion that there are such consumer boycotts which are effective but unsuccessful and vice versa, and that efficiency and success are not reciprocally implied. Some authors further emphasize the need for identifying and detecting specifics of various forms of boycotts. In this regard, there are so-called instrumental boycotts, targeted at specific products or producers, and expressive boycotts, which express the general opposition to a particular issue. Similar to that, there are strategic boycotts, aimed at changing a company's business policy, and deterrent boycotts, aimed at publicly exposing all the unethical associated with a particular product or a company.

Consumer boycotts equally affect all industries and brands – from fashion industry, where DKNY Company was pressured into accepting employee association's demands on preventing discrimination and employee abuse, or Benetton, which was forced to discontinue conducting experiments on animals, through automotive industry, where the Mitsubishi Company had to accept the responsibility for environmental problems in Mexico, to tourism, where the Royal Caribbean Cruises had to install wastewater purification equipment on their vessels (retrieved from <http://www.ethicalconsumer.org/linkclick.aspx?fileticket=cOrT55txMvI%3d&tabid=123> on 07.26.2012, 14:00). Unfortunately, there are virtually no such examples in Serbia, and every viable organization of consumers usually involves industrial consumers, such as raspberry manufacturers. There are many examples of failed consumer boycotts, such as the most recent one, the boycott of baby equipment due to enormous margins set by importers and distributors. The boycott took place during the winter of 2011/2012, but the government was not prepared to respond.

In spite of the popular opinion that every change in the conducts of a targeted company, caused by boycotts, suggests the success of a boycott, literature offers a much more complex approach to the assessment of consumer boycotts that encompasses the analysis of following indicators (Harrison, Newholm & Shaw, 2005):

- Survey data – consumers' responses in various surveys and questionnaires on their willingness to participate in a boycott or their actual participations are highly significant indicators of the success of a boycott, since they exhibit consumer's willingness to be actively engaged in boycotts, as well as their actual engagements.
- Financial data – financial reports of boycotted companies clearly indicate the price they paid for being the targets of consumer boycotts. Numerous consumer associations consider every decline of more than 2% in a targeted company's revenue to be an indicator of a successful boycott. The process of disinvestment, as an outcome of consumer boycotts, is also relevant to this topic, along with possible terminations of business arrangements with boycotted companies.
- Company's response to the boycott is decidedly significant, since it affects whether the boycott will arise in the first place, or escalate further:
  - ignoring consumer requests;
  - battling organizers and participants of the boycott;
  - better transparency of company's operations;
  - acceptance of demands;
- Recruitment of new employees – companies that were targeted by organized consumer boycotts often experience an additional, equally dangerous, supervening consequence. Experts and workers often refrain from applying for a job in such companies, which reduces their HR potential, and may drive these companies into serious problems in the long run.

## **ETHICAL CONSUMER ACTION IN ACHIEVING SOCIAL AND POLITICAL GOALS**

---

- Decontamination of the sector from disputable companies – consumer boycotts often facilitate a form of elimination, that is to say, purging companies that cannot meet consumers' ethical demands from the industry branch.
- Government response – success of a boycott increases if it results in government's specific reaction, like passing of a law or a regulation.
- Change in behaviour and perception of individuals on both supply-side and demand-side.

It is interesting to mention a new market phenomenon, identified by the latest research of consumer boycotts – besides (or owing to) the undisputable success of consumer boycotts, many consumers are turning to a more positive side of ethical behaviour – positive buying. This phenomenon was derived from the concept of consumption as economic voting (Shaw, Newholm & Dickinson, 2006). Positive buying involves positive ethical decisions and purchase choices, as a means of support for those producers who behave and do business ethically. Each consumers' purchase decision produces a cumulative effect on the economy, and therefore on society and culture in general. Thus, positive buying often has more substantial influence in comparison with consumer boycotts.

There are certain benefits of positive buying, such as (Shaw, Newholm & Dickinson, 2006, p. 1057):

- sending a clear message about concern for others;
- building a sense of belonging to the social environment for and individual;
- overall human existence

The success of positive buying is most frequently measured and rated by using the so-called Ethical Purchasing Index. The Co-operative Bank's Ethical Purchasing Initiative project is designed to measure the trends and UK market share of various ethical consumer goods and services. Designed in conjunction with the UK NGO New Economics Foundation, its methodology consists of defining an 'ethical shopping basket', tracking consumption in food, energy, housing, household goods, cosmetics, transport, charity and leisure. Their annual reports indicate a continuous increase in consumption of products and services with ethical attributes, but this is still significantly lesser than the consumption of other goods and services. In the literature, this is identified as the ethical consumer behaviour gap.

The success of positive buying is most often quantified and evaluated with the Ethical Purchasing Index. The Co-operative Bank's Ethical Purchasing Initiative project is designed to measure the trends and UK market share of various ethical consumer goods and services. Designed in conjunction with the UK NGO New Economics Foundation, its methodology consists of defining an 'ethical shopping basket', tracking consumption in food, energy, housing, household goods, cosmetics, transport, charity and leisure.

It is necessary to highlight that numerous campaigns for boycotts or positive buying have not provided benefits for all consumers, nor have they accomplished to achieve declared social and political goals. The best example of this is the Fair-trade Movement, which was criticized by many analysts for not providing any benefits to the underprivileged. Even if it did, it occurred in a much more complex and ineffective way than it was initially intended and later propagandized. (Harrison, Newholm and Shaw, 2005).

## Conclusion

Despite the problem of causation, many researchers agree that there is widespread and compelling evidence of consumer positive buying and boycott actions delivering on political and social goals.

Obviously consumer ethical behaviour cannot effectively address the full range of political, social and environmental issues, because they require choice and competitive markets to function. Ethical purchase behaviour is particularly useful at addressing global issues where national governments are reluctant to regulate. And unlike positive buying which tends to require surplus income, consumer boycotts also provide a useful mechanism for poorer marginalised or disempowered communities to defend their rights and interests. Consumer boycotts and positive buying can provide an excellent focus for grassroots public awareness raising which has to be the bedrock of any long-term social change, as well as to raise complex social issues in a way which has immediate relevance to a sometimes cynical and disillusioned public.

Consumer ethical behaviour provides people with a form of political action that is cheap, immediate, non-time consuming and not requiring of any special skill. What better way could there be to allow people who feel politically disempowered to start feeling they can have some influence?

## References

- Bray J., Johns N., Kilburn D. (2011.), *An Exploratory Study into the Factors Impeding Ethical Consumption*, Journal of Business Ethics 2011, Vol 98. No 4., pp 597-608
- Carrigan M., Attala A. (2001.), *The myth of the ethical consumer – do ethics matter in purchase behavior?*, Journal of Consumer Marketing, Vol. 18., No. 7, pp 560-577
- Carrington M.J., Neville B.A., Whitwell G.J. (2010.), *Why ethical Consumers Don't Walk Their Talk: Towards a Framework for Understanding the Gap Between Actual Buying Behavior of Ethically Minded Consumers*, Journal of Business Ethics 2010, Vol 97. No 2., pp 139-158
- Cherrier H., Murray J. (2002.), *Drifting away from excessive consumption: a new social movement based on identity construction*, Advances in Consumer Research, Vol. 29., pp 245-247
- De Pelsmacker P., Driesen L., Rayp G. (2005.), *Do Consumers Care about Ethics? Willingness to pay for fair-trade coffee*, The Journal of Consumer Affairs 2005, Vol 39. No 2., pp 363-385
- Galvagno M. (2011.), *The intellectual structure of the anti-consumption and consumer resistance field: an author co-citation analysis*, European Journal of Marketing, Vol. 45., No. 11., pp 1688-1701
- Harrison R., Newholm T., Shaw D. (2005.), *The Ethical Consumer*, London: Sage Publications Ltd.
- Hoffmann S. (2011.), *Anti-consumption as a means to save jobs*, European journal of Marketing, Vol. 45., No. 11., pp. 1702-1714
- Iyer R., Muncy J.A. (2009.), *Purpose and object of anti-consumption*, Journal of Business research Vol. 62., p. 160-168
- Shaw D., Newholm T., Dickinson R. (2006.), *Consumption as voting: an exploration of consumer empowerment*, European Journal of Marketing, Vol. 40., No. 9., p. 1049-1067
- Žnideršić Kovač R., Marić D. (2007.), *Društvene determinante ponašanja potrošača*, Ekonomski fakultet Subotica
- <http://www.ethicalconsumer.org/boycotts/successfulboycotts.aspx> (retrived July 26, 2012)
- <http://www.ethicalconsumer.org/linkclick.aspx?fileticket=cOrT55txMvI%3d&tabid=123> (retrived July 26, 2012)



# RISK PERCEPTION IN CHOOSING A DESTINATION: A CROSS CULTURAL STUDY AMONG ISRAELI AND SERBIAN TOURISTS

Vladimir Senić<sup>1</sup>

Veljko Marinković<sup>2</sup>

Ella Gordon<sup>3</sup>

**Abstract:** *An alarming increase in the number of terrorist attacks and incidents involving tourists in recent years has had a profound impact on how tourists make their decisions regarding traveling internationally. It seems that nowadays tourists have become more alert of the issues related to risks associated to traveling than ever before. Yet, on the other hand, various nationalities, mainly due to their historical and cultural background tend to have different worldview and perceive risk differently. The main focus of this paper is to investigate whether and to what extent does perceived risk play a role in choosing destination for Israeli and Serbian tourists. Through use of independent samples *t*-tests we examined whether there are statistically significant differences in perceptions among Israeli and Serbian tourists involving 26 risk attributes. By using explorative factor analysis, we determined the factorial structure of risk attributes on Israeli and Serbian samples. Originality and contribution of this research lies in the fact that there is a rather limited number of studies in the region of Southeast Europe and Middle East that focused on comparative analysis of perceived risk between nationalities that live in those two regions.*

**Keywords:** *traveling, destination, perception of risk, Israel, Serbia*

## Introduction

Over the last few decades travel and tourism have grown so significantly that tourism industry has become one of the most important sectors of the world economy. For instance, a recent report by Deloitte (2008) shows that tourists traveling to Great Britain make a total economic contribution of approximately €140.7 billion, accounting for 8.2 per cent of Great Britain's total GDP. On the other hand, it is documented that tourism sector employs well over 200 million people across the globe. Given such a sheer importance that tourism plays in the modern world economy, it appears that understanding consumer behavior is essential in tourism management. Due to the fact that nature of tourism contains such characteristics as intangibility, variability, perishability and inseparability, consuming tourist products always includes various elements of risk: from physical and financial, all the way to psychological. Consequently, being one of the central concepts of tourist behavior, risk plays a major role in decision making. Among a diversity of decisions tourist has to make in traveling, perhaps, one of the most important is the choice of destination. Though there are many elements involved in the decision-making process, the image of the destination plays a significant role. The main aspects the image of destination conveys, such as political, economic, cultural, are related in a certain way to security and safety matters.

Given the importance that the concept of risk plays in deciding on where, when and with whom to travel, we wanted to explore if the traveler's background traits (culture, social values, historical background, etc.) may play a significant role in how they approach risk. Namely, people from

---

<sup>1</sup> Faculty of Hotel Management and Tourism in Vrnjačka Banja, University of Kragujevac, vsenic@yahoo.com

<sup>2</sup> Faculty of Economics, University of Kragujevac

<sup>3</sup> Faculty of Hotel Management and Tourism in Vrnjačka Banja, University of Kragujevac

different cultures may tend to develop different views of risk and hence different destination images. In other words, destination and the risk associated with that destination can be perceived differently by tourists coming from different countries with their specific national cultures and backgrounds (Fuchs and Reichel, 2004; Reisinger and Mavondo, 2005). In order to further investigate this phenomenon, we focused our study on travelers from Israel and Serbia – two countries located at different continents, with different religious backgrounds and finally, different historical paths.

### **The Concept of Perceived Risk in Tourism**

Tourism is characterized by features mainly associated with service industry such as intangibility, variability and perishability that already increase consumers' risk perceptions in comparison when buying regular physical products. Furthermore, tourist product is often exposed to certain factors that influence tourist's perceived risk and often raise the level of risk perceived due to these factors. The scope of factors is broad: ranging from bad weather and food inedibility to crime, terror and political unrest (Fuchs and Reichel, 2004). Accordingly, the spectrum of perceived risks widens including anything from disappointment with destination as not being consistent with tourist's expectations to injury and even death.

Perceived risk is defined as “a consumer's perception of the overall negativity of a course of action based upon an assessment of the possible negative outcomes and the likelihood that those outcomes will occur” (Mowen and Minor, 1998). Risk perceived by tourists is also known in the research of tourism as a determinant of travel patterns in a variety of destinations (Sönmez, Apostolopoulos, Tarlow, 1999). The previous researches point out that tourist characteristics such as nationality, earlier tourist experience, gender, and quest for novelty have an impact on their perceptions of risk (Fuchs and Reichel, 2004; Pizam et al. 2004; Reisinger and Mavondo, 2005). While common border and language, fashion and distance are important issues, risk related to travel destination is one of the most influencing factors (Eilat and Einav, 2004).

Starting from the pioneering research of Roehl and Fesenmaier (1992) the concept of 'perceived risk' has received attention in the field of tourism research. Various studies found different dimension and aspects of risk perception in tourism. Roehl and Fesenmaier distinguished (1992) three major dimensions of perceived risk – vacation risk, physical-equipment risk, and destination risk. A later study by Tsaur, Tzeng and Wang (1997) in which two major types of risk were examined – physical and equipment – indicated that the importance of different factors of tourist perceived risk varies. Issues associated with law and order, were found to be the most significant factors of tourist risk perception. Various types of risk related to a number of factors such as crime, diseases, natural disasters, danger associated with means of transportation, cultural-language barriers were studied by Mäser and Weiermair (1998). The result of their research pointed out that perceived risk can serve as one of the explicatory variables in understanding tourist decision-making process. In addition, their study also indicated that tourists tend to seek more information if the risk is perceived as higher, thus rendering the decision-making process even more rational.

Several types of risk perceptions of different tourist destinations were measured by Sönmez and Graefe (1998 a, b). The risk types included financial, physical, psychological, social, political instability, terrorism and other risks. Their study suggested that there is a direct relationship between the level of perceived risk and international travelling destination choice concluding that the higher the level of perceived risk of the destination the higher are the chances that tourists would avoid travelling to the destination.

### **Perceived Risk in Tourist Decision Making**

Tourist consumer behavior and decision making have always gained attention in the research of tourism management. There is no one commonly accepted opinion in regards with typology and functions of decision making styles. However, a general basis is that decision making styles are affected by the situation of purchasing and by environments, such as risk. This belief is different from what early theory of decision making has suggested (Wong and Yeh, 2009). The early research of decision making proposed that during decision making process consumers generally behave in a rational way weighing in the balance existing alternatives (Josiam and Hobson, 1995). Nevertheless, when the choices they are about to make involve a certain degree of risk, decision makers in reality behave differently than it was previously theoretically assumed and tend to delay their decisions or even quit making decisions (Dhar, 1997). Thereby, Sönmez and Graefe (1998b) came to a conclusion that perceptions of risk and safety concerns play a very significant role in the decision making process of tourist consumer behavior for the reason that they can influence and eventually change rational decision making in relation to travelling manner and destination choice. Due to intensive media coverage, risk perceptions related to a certain destination in fact have significant influence on the decision making process and in certain cases can make a whole region seem risky.

### **Cultural Differences in Perceptions of Risk and Destination Image**

Definitions of culture also indicate that culture is “the sum of people’s perceptions of themselves and of the world” (Urriola, 1989). In other words, people from different cultures may have different perception of certain things and phenomena. It was found out that differences in national cultures are also related to the distinctions in perceived risk associated with international traveling. In his study Tremblay (1989) pointed out that American tourists tend to be more vulnerable to threat of international terrorism than European tourists. One of his explanations suggests that it is so due to the fact that American tourists are more often targets of terrorism and have been more exposed to media coverage of terrorist violence events. Fuchs and Reichel (2004) in their study about the relationship between national cultural differences, religion backgrounds and destination risk perceptions of tourists of different nations visiting Israel, found that destination risk perception differs across national cultures and religions. These findings were also supported by Reisinger and Mavondo (2005) who indicated that risk perceptions associated with traveling are determined by cultural orientation and psychological factors. This proves that tourist national cultural background can be a significant factor responsible for tourist risk perception.

Furthermore, the concept of national culture has been an important subject of study in the field of international business research. Hofstede, the pioneer researcher in culture and its effects on international management, developed a set of dimensions which being measured by survey instruments in order to find average values for a particular group of people, can thus be a measure of their national culture characteristics (Hofstede, 1980; Hofstede, 2001).

Recently conducted the GLOBE project based on Hofstede’s previous study provides deep understanding of cultural differences across nations and can serve as empirical basis in comparing national cultural characteristics. Uncertainty Avoidance, one of the dimensions studied in the project, refers to the degree to which members of a society seek consistency and orderliness in their lives and are intolerant to ambiguity (House et al., 2004). According to the GLOBE data, Serbia (with score 92) and Israel (with score 81) differ in this dimension.

## **Findings**

With an aim to understand perceptions of Serbian and Israeli tourists, an empirical study was conducted on a sample of 315 respondents. Some 47.6% of the sample are Serbian tourists (total of 150 respondents), while 52.4% of the sample involves Israeli tourists (total of 165 respondents). Data was collected in four Serbian cities (Kragujevac, Kraljevo, Čačak, Gornji Milanovac, Jagodina and Svilajnac) and four Israeli cities (Tel Aviv, Herzliya, Haifa, and Ashdod) in March of 2012. Data gathering was done through personal interview technique. Questionnaire included 22 statements, and respondents have expressed their level of agreement with them on a seven-point Likert scale (1 – I disagree completely; 7 – I agree completely). Statements were designed with the objective to learn more about: a) reasons why tourists visit a given destination, b) what types of destinations tourists prefer and c) to what extent are they willing to take risk when visiting a destination. The last two statements have given the opportunity to the respondents to evaluate the level of riskiness of Serbia and Israel as tourist destinations.

Data analysis was performed in Statistical Package for Social Sciences (SPSS) version 13. In terms of statistical analyses, arithmetic means of both sub-samples were calculated and independent samples t test were performed, in order to compare differences in means among respondents belonging to two observed segments. Afterwards, two factor analyses were performed – one on the sub-sample of Serbian tourist and the other on the sub-sample of Israeli tourists. The intent of the researchers was to determine similarities and differences among factorial structures of used statements in both groups of respondents. Statement consistency, which grouped around factors, was measured by Cronbach's alpha coefficient values.

Results of t-test point to a clear difference in attitudes and perceptions of Serbian and Israeli tourists (Table 1). Namely, based on 21 statements, statistically significant difference occurred in evaluations among respondents from two observed countries. Serbian tourists, unlike Israeli tourists, when deciding on a vacation destination prefer to visit locations that have similar cultural milieu (ambiance) as Serbia. Besides this, Serbs prefer to visit an urban setting, as well as summer resorts that offer quite and pleasant atmosphere and nice beaches. On the other hand, Israelis prefer new exotic destinations that are different from their cultural heritage.

An interesting result was the one that stresses that Israeli tourists expressed willingness to take a greater degree of risk in comparison to Serbian tourists. From the total number of statements in the questionnaire, 13 statements described different elements of perceived risk and in all these statements, a statistically significant difference occurred among the two segments of respondents. Particularly interesting responses were on the last two statements in the questionnaire. Namely, Serbs mostly perceive Israel as a risky tourist destination (average mark 4.38) in comparison to Israelis (average mark 3.45). Serbian responses imply that Serbs see Israel as a medium to high risk tourist destination, while Israelis see their own country as place that is in the zone of low to medium risk. On the other hand, both groups of tourists do not see Serbia as a risky tourist destination and no statistically significant differences emerged for this particular statement.



**Table 1: Results of independent samples t test**

Statements	Serbia Mean	Israel Mean	t value
For my trip I generally choose countries which are similar to my country from the cultural point of view	3.60	2.67	4.317**
My preferred destinations are places with seaside that offer nice beaches, tranquility and relaxation	5.72	3.90	9.811**
I prefer to spend my vacation in places with similar cultural surroundings.	3.63	3.00	2.917**
I like city tourism (e.g. visiting London, Rome, Paris, Madrid, Barcelona, Vienna, New York, Prague) with typical sightseeing	5.93	5.51	2.506*
My main motivation for travelling is to relax in a quiet place with peaceful atmosphere	4.86	3.35	7.206**
I accept some risk during my trip because risk is a part of adventure and excitement	4.03	4.70	- 3.211**
A possibility to experience a new culture is very important to me.	5.37	6.65	- 2.726**
My destination choice is based on my zest for excitement and cultural interest rather than on security issues of the country where I plan to go.	3.77	5.51	- 8.680**
I can / am willing to take a certain level of risk during my travel.	3.84	5.20	- 6.821**
I can / am willing to travel alone regardless the risk of my final destination.	2.80	4.94	- 9.766**
I am willing to take risk when necessary.	3.62	5.39	- 8.547**
Situations which have a minimum level of risk are not stressful to me	4.91	5.68	- 3.742**
I see risk as integral part of life	3.89	5.21	- 6.670**
I am a risk taker.	3.11	5.03	- 9.815**
Living in my country is risky (not secure and not safe).	3.66	5.65	- 10.267**
Due to the lifestyle of my country I am accustomed to risk and danger	3.88	5.47	- 8.505**
Constant exposure to some risk is a part of my everyday life	3.20	5.32	- 10.966**
The history of my country/nation has taught me to be ready to take a risk	3.95	5.65	- 8.965**
In the course of its history my country has generally been exposed to danger and threat	5.42	6.11	- 4.024**
Due to the history of my country/nation I am automatically prepared for danger and can adopt relatively easy to risky situations	4.27	5.69	- 7.576**
I consider Israel to be a risky tourist destination	4.38	3.45	5.039**
I consider Serbia to be a risky tourist destination	2.58	2.62	- 0.195 <sup>ns</sup>

\*\* p < 0.01; \* p < 0.05

As a method of factor analysis in this study we used principal component analysis. Varimax rotation was employed to derive a simple structure. In particular, we conducted two separate factor analyses – on both sub-samples. In the Serbian sample, we identified a total of six factors: a) willingness to accept risk, b) risk as a part of lifestyle, c) environments with similar cultural characteristics, d) risk as a part of historical heritage, e) leisure and f) cultural exoticness. Together, these factors describe a total of 64.9% of total variance (Table 2). All factors, except the last one have an acceptable level of confidence (Cronbach's alpha > 0.6). The last factor, cultural exoticness has a somewhat lower level of reliability (Cronbach's alpha = 0.55). The value of KMO index (Keiser-Meyer-Olkin) is 0.728. Given that this value is greater than the needed minimal threshold of 0.5, it can be concluded that the data is adequate for use of factor analysis. Bartlett's test of sphericity is also highly significant ( $p = 0.000 < 0.05$ ).

**RISK PERCEPTION IN CHOOSING A DESTINATION: A CROSS CULTURAL STUDY AMONG ISRAELI AND SERBIAN TOURISTS**

**Table 2. Principal component analysis results (Serbian sample)**

<b>Factors</b>	<b>Factor loading</b>	<b>% of variance explained</b>	<b>Cronbach's Alpha</b>
<b>F1: Willingness to take risk</b>		16.514	0.82
I am willing to take risk when necessary	0.780		
I can / am willing to travel alone regardless the risk of my final destination	0.771		
I am a risk taker.	0.728		
I can / am willing to take a certain level of risk during my travel	0.723		
I accept some risk during my trip because risk is a part of adventure and excitement	0.633		
I see risk as integral part of life	0.584		
<b>F2: Risk as a part of lifestyle</b>		11.866	0.75
Due to the lifestyle of my country I am accustomed to risk and danger	0.831		
Living in my country is risky (not secure and not safe)	0.824		
Constant exposure to some risk is a part of my everyday life	0.640		
<b>F3: Environments with similar cultural characteristics</b>		10.322	0.91
I prefer to spend my vacation in places with similar cultural surroundings	0.921		
For my trip I generally choose countries which are similar to my country from the cultural point of view	0.900		
<b>F4: Risk as a part of historical heritage</b>		9.560	0.67
Situations which have a minimum level of risk are not stressful to me	0.703		
Due to the history of my country/nation I am automatically prepared for danger and can adopt relatively easy to risky situations	0.590		
The history of my country/nation has taught me to be ready to take a risk	0.538		
In the course of its history my country has generally been exposed to danger and threat	0.502		
<b>F5: Leisure</b>		9.100	0.61
My preferred destinations are places with seaside that offer nice beaches, tranquility and relaxation	0.808		
My main motivation for travelling is to relax in a quiet place with peaceful atmosphere	0.578		
<b>F6: Cultural exoticness</b>		7.538	0.55
A possibility to experience a new culture is very important to me	0.757		
I like city tourism (e.g. visiting London, Rome, Paris, Madrid, Barcelona, Vienna, New York, Prague) with typical sightseeing	0.612		
My destination choice is based on my zest for excitement and cultural interest rather than on security issues of the country where I plan to go.	0.601		

Total percentage of explained variance 64.900%; KMO = 0.728; Bartlett Test of Sphericity: p = 0.000

Within the Israeli sample a somewhat different results were obtained. In the first iteration four factors were identified. However, one factor which had two statements (I like city tourism - e.g.

visiting London, Rome, Paris, Madrid, Barcelona, Vienna, New York, Prague - with typical sightseeing; A possibility to experience a new culture is very important to me) had quite low level of confidence measured through Cronbach's alpha coefficient. Therefore, we decided to exclude these statements from the factor analysis. After the second iteration, three factors with adequate levels of confidence emerged (Cronbach's alpha > 0.6) and all factor loadings of the remaining statements had values that were higher than 0.5 (Table 3). As the final result, three factors were formed: a) willingness to take risk, b) risk as a part of lifestyle and historical heritage and c) leisure. These factors described 61.962% of total variance. Once again, adequate data for use of factor analysis were used (KMO = 0.856 > 0.5; Bartlett test of sphericity p = 0.000 < 0.05).

**Table 3. Principal component analysis results (Israel sample)**

Factors	Factor loading	% of variance explained	Cronbach's Alpha
<b>F1: Willingness to take risk</b>		28.512	0.91
I accept some risk during my trip because risk is a part of adventure and excitement	0.787		
I can / am willing to take a certain level of risk during my travel	0.773		
My destination choice is based on my zest for excitement and cultural interest rather than on security issues of the country where I plan to go.	0.765		
I am a risk taker	0.758		
Situations which have a minimum level of risk are not stressful to me	0.746		
I can / am willing to travel alone regardless the risk of my final destination	0.729		
I see risk as integral part of life	0.725		
I am willing to take risk when necessary	0.720		
<b>F2: Risk as a part of lifestyle and historical heritage</b>		18.314	0.82
The history of my country/nation has taught me to be ready to take a risk	0.815		
In the course of its history my country has generally been exposed to danger and threat	0.701		
Due to the lifestyle of my country I am accustomed to risk and danger	0.645		
Living in my country is risky (not secure and not safe)	0.623		
Due to the history of my country/nation I am automatically prepared for danger and can adopt relatively easy to risky situations	0.581		
Constant exposure to some risk is a part of my everyday life	0.519		
<b>F3: Leisure</b>		15.136	0.78
I prefer to spend my vacation in places with similar cultural surroundings	0.843		
For my trip I generally choose countries which are similar to my country from the cultural point of view	0.746		
My preferred destinations are places with seaside that offer nice beaches, tranquility and relaxation	0.702		
My main motivation for travelling is to relax in a quiet place with peaceful atmosphere	0.690		

Total percentage of explained variance 61.962%; KMO = 0.856; Bartlett Test of Sphericity: p = 0.000

## **Conclusion**

Based on the results of the conducted analysis it can be inferred that Israeli tourists are to a greater extent willing to accept risk that is associated with travelling in comparison to Serbian tourists. Such conclusion is derived from the fact that in their history, Israeli population was commonly in the conflict with the neighboring nations, while high tensions with Palestinians remain to this day. On the other hand, Serbia due to its geographic position was either involved or was near war efforts. The most recent example was the civil war that took place in ex-Yugoslavia that culminated with NATO bombing of Serbia in 1999. Yet, in the last 12 years overall in Serbia situation can be assessed as stable which led to lower levels of acceptable risk when travelling in comparison to Israelis. It is interesting to note that even on the Serbian sample we can see a moderate level of willingness to take risk. Certainly, it would be interesting to study if this level is higher compared to other European nations that did not go through war efforts. Nevertheless, in the Israeli sample a rather high level of willingness to accept risk was evident.

Differences have also been reflected when it comes to reasons that motivate tourists to visit a certain destination. For example, Serbs prefer visiting urban settings and vacationing in resorts with beautiful seas and beaches. On the other hand, Israelis prefer exotic destinations and desire to see and experience something new, that is, something different from what they have previously visited and what is different in comparison to their cultural framework.

Results of factor analysis of the two samples showed certain differences, as well as, similarities. In Serbian sample we obtained six, while in the Israeli sample we obtained three factors (however, in the first iteration the Israeli sample had four factors, with one factor being excluded from further analysis due to low level of internal consistency of statements of which it was comprised). During factor formation, differences were particularly evident due to the fact that the factors in the Israeli sample generally comprise of more statements in comparison to the Serbian sample. In fact, statements that were in the Serbian sample grouped around two factors (risk as a part of lifestyle; risk as a part of historical heritage) and in the Israeli sample statements grouped around a single factor (risk as a part of lifestyle and historical heritage). Similar situation was with factors (a) environments with similar cultural characteristic and (b) leisure from the Serbian sample that emerged as a single factor, leisure, in the Israeli sample. However, it is evident that even with noted differences the factor structures of statements in both samples possess a certain level of consistency.

This paper represents a landmark study when it comes to comparing risk perceptions between Serbian and Israeli travelers. The findings yield practical directions to decision makers in travel agencies, as well as to tour operators that can plan tourist arrangements to Serbian and Israeli travelers that are in accordance with their perceptions of risk. This study enables not only for more sophisticated market segmentation, but also it allows for differences among travelers to be valued appropriately. In that sense, marketers can identify the most critical differences in terms of risk perceptions and then create different marketing strategies tailored to different nations and/or cultures based solely on how they perceive risk. This can be successfully done by implementing marketing promotional campaigns that will aim to reduce particular types of risk therefore making certain destinations more attractive and appealing for prospective tourists coming from different cultural backgrounds.

## References

- Deloitte (2008). *The Economic Case for the Visitor Economy*. London: Deloitte MCS Limited.
- Dhar, R. (1997). Consumer Preference for a No-Choice Option. *Journal of Consumer Research*, 24, 215-231.
- Eilat, Y. and Einav, L. (2004). Determinants of International Tourism: A Three-Dimensional Panel Data Analysis. *Applied Economics*, 36, 1315-1328.
- Fuchs, G. and Reichel, A. (2004). Cultural Differences in Tourist Destination Risk Perception: An Exploratory Study. *Tourism*, 52, 21-37.
- Hofstede, G. (1980). *Culture's Consequence: International Differences in Work-Related Values*. Beverley Hills: Sage.
- Hofstede, G. (2001). *Culture's Consequences: Comparing Values, Behaviors, Institutions and Organizations Across Nations*. Thousand Oaks: Sage.
- House, R. J., Hanges, P.J., Javidan, M., Dorfman, P.W. and Vipin, G. (2004). *Culture, Leadership, and Organizations: The GLOBE Study of 62 Societies*. Thousand Oaks: Sage
- Josiam, B. and Hobson, J. (1995). Consumer Choice in Context: The Decoy Effect in Travel and Tourism. *Journal of Travel Research*, 34, 45-50.
- Mäser, B. and Weiermair, K. (1998). Travel Decision-Making from the Vantage Point of Perceived Risk and Information Preferences. *Journal of Travel and Tourism Marketing*, 7, 107-121.
- Mowen, J. and Minor, M. (1998). *Consumer Behavior*, 5<sup>th</sup> ed. Englewood Cliffs: Prentice Hall.
- Pizam, A. and Mansfeld, Y. (1999). *Consumer Behavior in Travel and Tourism*. New York: Haworth Hospitality Press.
- Reisinger, Y. and Mavondo, F. (2005). Travel Anxiety and Intentions to Travel Internationally: Implications of Travel Risk Perception. *Journal of Travel Research*, 48, 212-225.
- Roehl, W. and Fesenmaier, D. (1992). Risk Perception and Leisure Travel: An Exploratory Analysis. *Journal of Travel Research*, 30, 17-26.
- Sönmez, S, Apostolopoulos, Y. and Tarlow, P. (1999). Tourism in Crisis: Managing the Effects of Terrorism. *Journal of Travel Research*. 38, 13-18.
- Sönmez, S. and Graefe, A.R. (1998a). Influence of Terrorism Risk on Foreign Tourism Decisions. *Annals of Tourism Research*. 25, 112-144.
- Sönmez, S. and Graefe, A.R. (1998b). Determining Future Travel from Past Travel Experience and Perceptions of Risk and Safety. *Journal of Travel Research*, 37, 172-177.
- Tremblay P. (1989). Pooling international tourism in Western Europe. *Annals of Tourism Research*, 16, 477-491.
- Tsaur, S., Tzeng, G. and Wang, K. (1997). Evaluating Tourist Risks from Puzzy Perspectives. *Annals of Tourism Research*, 24, 796-812.
- Urriola, O. (1989). Culture in the Context of Development. *World Marxist Review*, 32, 66-69.
- Wong, J.Y. and Yeh, C. (2009). Tourist Hesitation in the Destination Decision Making. *Annals of Tourism Research*, 36, 6-23.



# THE ROLE OF EVENTS IN STRATEGIC (RE)POSITIONING OF A TOURIST DESTINATION

Ilija Morić<sup>1</sup>

Olivera Simović<sup>2</sup>

**Abstract:** *Events are considered to be a part of the attraction of a tourist destination. Undoubtedly, events represent an efficient and innovative tool for creating new marketing opportunities for a tourist destination, and are included in the destination's branding strategy. On the other hand, relatively limited research has been conducted on the methods of tourist destination (re)positioning via events, despite the growing use of this innovative promotional strategy. In this sense, the paper examines the role of events in tourist destination (re)positioning, especially as a part of the integrated destination marketing strategy. The main hypothesis is that events could influence on the (re)positioning of a tourism destination, generating certain economic and socio-cultural benefits for all stakeholders in the tourism industry. In particular, methods of coordinated co-branding of events and destinations are examined. Practical implications are derive, and suggested for tourism policy makers in a tourist destination.*

**Keywords:** *event, tourist destination, (re)positioning, marketing.*

## Introduction

Modern tourism is seen as growing industry that is capable to generate important economic benefits and other social and environmental impacts for destination and individual business, as well (e.g. Bull, 1995; Cooper et al, 2005; Goeldner, 2006; Bhatia, 2006). On the other hand, events represent the attractions of a tourist destination, and very efficient and innovative tool for attracting tourists to a certain destination, increasing their average spend, length of stay etc. For a destination to be competitive in today's tourism market, it is necessary that the destination can be distinguished by its values, people, products, nature, events and manifestations, history or a combination of all of the above. However those advantages have to be put together in a simple, true, characteristic and attractive offer that can be a powerful tool of self promotion and success. In this sense, events are seen as efficient marketing tool that could integrate all advantages of a tourist destination, tangible and intangible, and offer them as a product to tourists. Undoubtedly, modern events are image-makers that could position the destination in the market and create competitive marketing advantage (e.g. Getz, 2004; Bowdin et al., 2004; Mastermann, 2006; Smith, 2009.).

Positioning is considered to be the key element of a successful marketing. Chacko and Marcell (2008) discuss about repositioning of New Orleans as a tourism destination after the devastating effects of Hurricane Katrina in August 2005. They examine the effectiveness of recovery marketing strategies, especially the repositioning strategies created and undertaken by destination marketing organizations. Also, Prentice and Andersen (2003) argue the effects of the International Festival in Edinburgh on the modification of the general image of Scotland among its tourists as a "landscape and tradition" destination. Edinburgh International Festival is of substantial economic importance, and in 1997 it generated an estimate £125 million for the economy, and 4000 jobs (Bowdin et al., 2004). Marzano and Scott (2006) discuss on events as part of the attraction of a destination and as important

---

<sup>1</sup> Faculty of Tourism and Hotel Management, University of Montenegro, imoric@t-com.me

<sup>2</sup> Faculty of Tourism and Hotel Management, University of Montenegro

part of integrated marketing strategy for the destination, as well. Moreover, they indicate that events' contributions are not just in terms of the direct economic benefits, but also in terms of increasing destination brand value and image (e.g. Getz, 2004; Smith, 2009). In line with these authors, we contend that events are considered to be an innovative, but still not enough used tool for effective promotion and positioning. Accordingly, this paper aims to provide insight into the role of events in tourist destination (re)positioning, with specific references to practical implications and concepts.

With regards to above mentioned, the structure of this paper consists of three interrelated parts. The first part gives the overview of conceptual basis of the events and their role in modern tourism. Fundamental concepts of tourist destination (re)positioning via events are analyzed in the second section. The third section gives an insight in experiences of events tourism across the world that acknowledges the relevance of strategies and principles mentioned in previous parts.

### **Conceptual basics of events**

Although events could be divided into planned and unplanned, in the context of tourism, planned events are more important. Planned events are spatial-temporal phenomenon, and each one is unique due to the interaction between environment, people and management systems, including design elements and programs. Events are never exactly alike, and tourists have to "be there" to enjoy the unique experience.

The rapid growth of events in the past decades consequently led to the emergence of an events industry with "its own body of knowledge, job opportunities and career paths" (Bowdin et al, 2004, 12). Moreover, this industry has its own associations, training courses and educational programmes delivered by colleges universities, accreditation schemes etc.

Events could be differentiated according to its size and impact, or type and sector. In line with this, events could be categorized as special events, mega-events, hallmark events, major events, or public, cultural, festivals, sporting, tourism and corporate events (eg. Jafari, 2000, Bowdin et al., 2004, Allen et al., 2005). Greater importance of the event and the higher percentage involvement of international and regional celebrities in the event create the higher media coverage of the event, that represents a successful promotion of the destination.

Determination of the vision, mission and guiding actions are the main tasks of strategic planning of events (Bowdin et al., 2004; Allen et al., 2005). Practice shows that the most successful results of strategic planning are from the vision and not from formal long-term plans Therefore, strategic planning, and is manifested as a strategic planning focused on implementation defined by vision. Implementing the vision of events includes defining the objectives of events, which are essentially related to (Allen et al, 2005): defining the size of the event, choice of environment of the events, market positioning of the event, event marketing programs, setting up the financing and execution of events.

The impacts of events could be with positive and negative effects on local community and tourism industry in the destination. The optimum balance between these effects should be managed in order to maintain the effectiveness and efficiency of an event and tourism industry, as well. According to Bowdin et al. (2004, 27), the impacts could be categorized in following spheres: (1) Social and cultural, (2) Physical and environmental, (3) Political and (4) Tourism and economic.

Positive social and cultural impacts could be the following: shared experience, revitalising tradition and community pride, increased community participation, introduction of new ideas etc. Negative impact could be: community alienation, manipulation of community, negative community image, social dislocation, loss of amenity etc. Positive physical and environmental impact could be: showcasing the environment, providing models for best practice, increasing environmental awareness,



urban transformation, improved transportation and communications. As negative impacts, following are identified: environmental damage, pollution, destruction of heritage, noise disturbance, traffic congestion etc. among positive political impacts, the following are most important: international prestige, promotion of investment, social cohesion. Also, a number of negative impacts are also present, such as: risk of event failure, misallocation of funds, loss of community ownership and control etc. The impact from tourism and economic sphere are probably the most relevant in our case. The most important positive effects are (Bowdin et al, 2004, 28): destination promotion and increased tourist visits, expanded length of stay, higher yield, increased tax revenue, job creation etc. Negative impact could be the following (2004, 28-29): community resistance to tourism, loss of authenticity, damage of reputation, exploitation, inflated prices, opportunity costs etc.

One of the most important impacts of events is the fact that they could generate benefits to the tourism industry in the low season, when the number of tourist arrivals is declining and there are unutilized accommodation and transport capacities. Events in off season period have the potential to generate important economic benefits for the whole tourism industry, in a way that increases local operations, reservations in hotels and restaurants, transportation etc. A strong advantage is also the possibility to distribute the events throughout the year, where adequate combination of different types of events (business, cultural, sporting...) will generate full benefits for the tourist destination and individual businesses. The events can also encourage tourists to stay longer at the destination. Events are means to reach a certain target market or to expand the market. They strengthen the image of the destination, assist in the promotion, positioning and branding of destinations. Long-term benefits of the host of the events can be the improvement of infrastructure (hotel and facility development, improved road and public transport networks etc), the investments by large companies, the increased quality of life for local people, an enhanced experience for visitors, and brand building for the destination and added value to the identity of the destination. (e.g. Getz, 2004; Bowdin et al., 2004; Allen et al., 2005).

### **Events in function of (re)positioning the tourist destination**

Positioning is referred to the process of “creating and sustaining a long-term adorable image or perception among prospective customers and other key stakeholders” (Middleton et al., 2001, 199). Positioning is essentially a strategy used by the marketer in an attempt to connect adequate niche with adequate marketing mix. This concept has equal importance for product, price, promotion and place (4P), which means that it cannot be described just as a promotional strategy. Positioning is especially important when confronted with strong competition. Positioning is a decision to serve a particular segment with a program tailored to those specific customer needs, in a way that a company discovers different needs in the marketplace, segments the market accordingly, targets those needs that it can satisfy in a superior way, and then selects and communicates a position which is relevant, effective and consistent with the company’s distinctive marketing mix and image. Also, positioning is the act of occupying a distinctive place in the mind of the target market (Kotler et al., 2006). Lack of successful positioning consequently leads to inconsistent image, confusion and a poor classification. On the other hand, efficient positioning has the potential to secure long-term profitability and competitiveness (Middleton et al., 2001).

Events and destinations are two different entities, but still "serve" each other in a certain way. The research of Erfurt and Johnsen (2003), shows that events affect the image of the destinations. They argue that it is extremely important that the events are carefully selected for the destination, because each event can always have both positive and negative effects on the destinations image. Hence, the events have the ability to represent the tourist destination. Over time, event and destination can become interconnected, such as, for example, Rio de Janeiro and its Carnival. In this case, event becomes the "driving force" that creates the real reason why tourists visit a particular destination, in

## **THE ROLE OF EVENTS IN STRATEGIC (RE)POSITIONING OF A TOURIST DESTINATION**

---

particular time of year. On the other hand, the attention should be drawn to the potential negative consequences of co-branding events with the destination and vice versa, if the character and content of an event is wrong or inappropriate.

Regarding strategic positioning via events, Getz (2004) has defined several marketing strategies, that include events that develop the theme and image, mega and well-known events with high attractiveness, hallmark events, variety of authentic events, that express local community culture, tradition and identity, and combination of these mentioned. Destination can use elements of those strategies, if deemed it necessary and important. First, events can be used as the main attraction around which destinations can develop a theme and creates an image. In this strategy events are used as the main focus of the promotion or as an added value to the topic. This type of strategy is suitable for small and large cities, as well as rural areas that lack basic tourist infrastructure. Therefore, the way destinations position themselves could be largely the result of one or more events. In each strategy, it is desirable that the destination has one or more of the hallmark or major events, so that the image of these events and the destination become inseparable and mutually supportive. Some destinations want to attract new and often one-time, mega, events with media attractiveness and tourist value. The prerequisite for this type of strategy is a huge budget and sophisticated marketing activities. The downsides of this are high costs, negative impacts of tourism events and the perception that the views of residents are not sufficiently taken into account. This carries the risk of alienation of the population in relation to the event, which is contrary to the principles of sustainable tourism development. The use of mega events as a strategy for tourism development is perfect for tourist destinations, and could be effective in attracting attention and increasing the number of visitors. Events like the Olympics and other mega sporting events are popular for achieving these goals. The use of mega events as a strategy for tourism development, however, is very expensive and government participation is vital. Certain strategies can be targeted to enhance existing events in those with hallmark status, which is a process that can be said to "institutionalize" the events. More and more destinations are developing a trend of creating great events as part of a sophisticated strategy of branding.

Owning a variety of events in the local community can be seen as a generic event tourism strategy. Instead of trying to attract and create new and great events, this strategy should be based on existing and new local developments. In addition, the strategy contributes to the authenticity, diversity, and supports stronger communities and is attracting and satisfying visitors. Portfolio of events attracts tourists of all age groups that have different interests. Also, portfolio of events is contributing to the destination image, based on attractions, services, accessibility, local festivals, experience etc. Effective events in positioning the destination are authentic ones that express the specifics of their community (Bowdin et al., 2004). The role of local community in this sense is quite important, and refers to their active participation in planning, organisation and control of whole management process of an event. In this way, the event will not be compromised by tourism. On the other hand, tourists are interested in local lifestyle and want to experience all the elements of local authentic way of living. In this sense, the inauthentic events that sometimes occur in destinations need to be countered, in order to stop the creation of bad image of a destination. Hence, only authentic events should be included in the portfolio because they can successfully enhance the visitor experience and destination brand. If it is a less attractive destination, which provides fewer opportunities for tourists, but in the right way connects to a specific event, for example, sport, that attracts a specific target group, it will definitely improve the experience of destination image.

### **Experiences of the tourist destination (re)positioning via events**

Events can make the city more attractive for tourists and locals. In addition, the events have an important significance in the revival of its vision of tourism development strategy. The goal of tourism organizations and destinations should be to achieve a good mix of events that will make the city more

attractive. This is accomplished through the recruitment of new events, support existing and repeat events, as well as providing assistance and cooperation of organizations and institutions involved in the events. Strategy "important events for the tourism of the city," is in Helsinki properly implemented, for the first time in the year 2000, when the city was one of the European Capitals of Culture (Erfurt and Johnsen, 2003). During this year several different events were deployed in Helsinki, and these events increased publicity for the city and were leading to the perception that events are a great potential for attracting tourists. As a result, preliminary planning of event tourism has begun. Before this year, events had only a minor role in the tourism strategy of Helsinki. In Helsinki, the role of events in destination marketing can be described as a slogan: "There is always something happening in Helsinki."

National tourism organizations should also include the events that have international significance as part of its strategy. Roche (2006) sees the events as an "important elements in the orientation of national societies to international or global society". Indeed, many countries have used **mega sporting events** in order to gain legitimacy and reputation and to highlight its achievements, support trade and tourism, or assist in the process of opening their country to global influences. It is much more than just marketing space it is to contribute to building the national identity as well. The countries and cities compete for the mega event to showcase its economic dynamism and modernity. Some of the most important sporting mega events are: Olympic Games, European Football Championships, World Cup etc.

There are several academic studies that examine the capacity of **Olympic Games** to enhance the position of the host city (and country) in international markets – at least in the short-term. In the case of Olympics in Sydney in 2000, four core strategic elements are chosen: (1) repositioning the country by capitalizing on media, (2) aggressively seeking convention business, (3) minimizing the diversion effect<sup>3</sup> of the Games, and (4) promoting pre- and post-Games touring. Australian tourism marketers wanted to divest Australia of the "Crocodile Dundee" image by which it was still perceived in many of its international markets. They wanted to project an image of a diverse and modern country with a unique look and feel. Three key tactics were implemented pursuant to the repositioning strategy: (1) the Visiting Journalists Program, (2) Olympic media programs, and (3) a sponsor relations program. In the post-Games period, a follow-up strategy is being implemented. (Chalip, 2002)

For example, Greece has benefited in the business segment, improving the image, visibility and attractiveness of the organization from the Olympics in 2004. In the year of the Olympics, "the cradle of civilization" was visited by 18 million tourists (growth of 13% over the previous year), tourism revenue was 18 billion Euros (an increase of 18%), revenues from the sale of television rights amounted to 732 million dollars of sponsorship cost was around \$ 180 million (Smith, 2006). Significant positive effects of the Greek economy was recorded after the Games as well - an annual economic growth of 4.1%, exports rose 31.5%, the second consecutive year Greece was visited by more than 14 million tourists, and tourism is 19% of GDP.

The **European Football Championship** is a great driver of the economy, too. The official sponsor of the European Championships since 1992 year showed that the EURO in Portugal 2004<sup>th</sup> has brought 800 million euro turnover to the European economy. The championship had over one billion viewers over the small screen monitors; this provided an excellent promotion of Portugal, a consultancy company DTZ estimated that in the Portuguese revenue of tourism by 2010 will receive additional 266 million because of the EURO. (<http://www.sportbusiness.com/news/163041/european-economy-to-receive-1-4-billion-boost-from-uefa-euro-2008>, 10.08.2012.).

---

<sup>3</sup> The effect when potential visitors avoid host city (or country) during the mega events, such as Olympic Games, due to the expectation that accommodation would be full, attractions would be busy, and transportation would be crowded, and could cause potential visitors to seek an alternative destination.

## **THE ROLE OF EVENTS IN STRATEGIC (RE)POSITIONING OF A TOURIST DESTINATION**

---

Kim and Morrison (2005) argue that the **Football World Cup** held in Japan and South Korea in June 2002 as the first event of such significance held in Asia in the 21st century, and to the common organization of countries hostile to the past, had multiple benefits for South Korea. First of all, more than 230 thousand football fans from around the world visited the Japan and Korea. The average tourist spent 2 242 dollars. About 32 thousand new jobs were open, and direct effects of total consumption amounted to 1 351 billion dollars. According to estimates by Samsung Economic Research Institute, thanks to victories of South Korea over the strong European teams such as Italy, Spain, Portugal and Poland, its image and its products, increased tangible and intangible values.

Events of all kinds can make the city more pleasant, interesting, and great events can help to increase the popularity and create an image of the city. For example, **Carnival** is celebrated in many catholic countries, but Carnival in Rio de Janeiro is the biggest and most popular in the world. Foreign visitors number around 500 000 every year (Smith, 2009). This carnival presents the combination of cultures of colonial Portuguese rulers, African slaves and native Indians, resulting in a colourful and authentic cultural event (Smith, 2009). Carnivals and similar festival are today seen as efficient tool to address seasonality. If we want to build the image of a dynamic and rich cultural city, it is necessary to invest in this direction of event tourism, which will tell an interesting story about heritage and lifestyle of the destination, but in a dynamic way. For example, in Copenhagen tourist organization has a clear picture of events that they do not want, such as carnivals, because they bind to Brazil.

It is also essential in the process of searching for specific events that events correspond to the desired image of the city. For example, some events generate the image of modern European metropolis, and others tend to preserve the traditional image of the city. There is an increasing number of cities that get the gay-friendly etiquette, that attracts visitors, investments and other economic benefits leading to revitalisation, regeneration and successful development. Amsterdam, London, Manchester or Sydney are just some of examples of cities that are characterized as more vibrant, diverse, tolerant and modern than others. **LGBT (Lesbian, Gay, Bisexual and Transgender) events and destinations**, are becoming increasing popular within the gay and mainstream markets, but in same time they are highly politicised, and in some case too much commercialized. The city of Manchester in England is one of the most gay-friendly cities in the country, and consequently it was promoted as a gay tourism destination in United Kingdom. Similar strategies have the destinations in Spain (e.g. Canary Islands), Florida or cities in Australia (e.g. Sydney) (Smith, 2009).

Also, **small events, based on local tradition and community festivals** can be very important for the destination, because they have community support. That is not the case with mega events, when the community could be marginalised. There are many examples of small events that become big in sense of their popularity. Recently, most popular are gastronomic events combined with culture, tradition elements and specific way of living, in general (eg. Wine, Olive Oil, Food Festivals etc.).

### **Conclusions**

Destinations that have experienced the significant growth in tourist arrivals are in fact large-scale event locations. Experiences of several host cities and countries show that mega events have the potential to generate high economic and other benefits, and also huge benefits in context of competitiveness and long-term profitability. Mega events, such as sporting events, represent a privileged opportunity for local development that is followed by increasing competition among the diverse tourist destinations that want to host these events. On the other hand, small, authentic events with high local community participation probably don't offer the possibilities as the mega ones, but are also very important in terms of enhancing the image and diversifying the offer. The key challenge regarding mega events is the great risk that events could fail and high costs, that are not followed by adequate returns. Also, the control of these events is not usually in hands of local community.

Moreover, these events do not automatically lead to the expected results. Especially, long-term positive effect could be very problematic and often are not achieved.

Based on practical and academic researches examined in previous parts of this paper, following practical implications are derived:

- In order to effectively (re)position the destination in a international market in long-term, there is a need for authentic events that express the specifics of a destination, its culture, tradition and identity;
- For short-term (re)positioning, mega events could be suggested, although they are mostly privilege of well developed countries with adequate infra- and superstructure, and with adequate funds for further improvement and development.
- Careful choice of events (mix or portfolio) should be created, in order to avoid unwanted image of a destination, or image which does not clearly differ a destination from the other similar.
- Adequate portfolio of events in a destination is needed in order to attract certain target groups of tourists, with economic, social and cultural impacts they generate during their stay in a destination.
- Local community participation is highly recommended in order to ensure the authenticity and attract the tourist to see, do and experience the local way of living.
- The control of event should be in hands of local community, in order to avoid too much commercialization and simplification of the event, especially those with important cultural, traditional and identity elements.

The events are an important tool for reviving the destination during off season period. This approach is important for all destinations that have seasonal problems, and in which events are particularly important for the revival of tourism facilities and filling all capacities. Undoubtedly, further research is necessary to identify key success factors regarding organisation of an event in function of tourist destination positioning, but, nevertheless, these findings could contribute to a broader understanding of the phenomenon of event tourism and event industry.

## **References**

- Aitken, J. (2002). *The Role of Events in the Promotion of Cities*, proceedings of International Conference “Events and Place Making”. Sydney: Australian Center for Event Management
- Allen J. et al. (2005). *Festival and Special Events Management*. Milton: John Wiley & Sons Australia Ltd.
- Bhatia A. K. (2006). *The Business of Tourism: Concepts and Strategies*. New Delhi: Sterling Publishers Private Limited.
- Bowdin G. et al. (2003). *Events Management*. Oxford: Elsevier Ltd.
- Bull A. (1995). *Economics of Travel and Tourism*. Melbourne: Addison Wesley Longman Australia Pty Ltd.
- Chacko H. E. and Marcell M. H. (2008). Repositioning a Tourism Destination: The Case of New Orleans after Hurricane Katrina. *Journal of Travel & Tourism Marketing*, Volume 23, Issue 2-4, pg. 223-235.
- Chalip L. (2002). *Using the Olympics to Optimise Tourism Benefits*. Centre d'Estudis Olímpics i de l'Esport (UAB).
- Cooper, C. et al. (1998). *Tourism – Principles and Practice*, Harlow, Essex, Longman, 1998.
- Erfurt R. A. and Johnsen J. (2003). *Influence of an Event on a Destination's Image – The Case of the Annual Meeting of the World Economic Forum (WEF) in Davos/Switzerland*, *Tourism Review*, Vol.,

## **THE ROLE OF EVENTS IN STRATEGIC (RE)POSITIONING OF A TOURIST DESTINATION**

---

- Getz, D. (2000). *Developing a Research, Agenda for the Event Management Risk in Events Beyond 2000: Settings the Agenda*. Proceedings of Conference on Event Evaluation, Research and Education. Sydney. July 2000, pp. 9–21. (URL: <http://bussines.edu.au>).
- Getz, D. (2004). *Event Management & Event Tourism*. 2nd edition. Lecture material for Event Management course. The School Economics and Commercial Law.
- Getz, D. and Frisby, W. (1988). Evaluating Management Effectiveness in Community-Run Festivals. *Journal of Tourism Research*, Vol. 27, p.22-27.
- Goeldner C. R. and Brent J. R. (2006). *Tourism: Principles, Practices, Philosophies*. 10th ed., New Jersey: John Wiley & Sons, Inc.
- Hall C. M. (1997). *Hallmark Tourist Events: Impact, Management and Planning*, New Jersey: John Willey and Sons.
- Jafari J. (2000). *Encyclopedia of Tourism*. London: Routledge.
- Kenyon, P. (2002). *Role of Special Events in Rural Revitalization*, Proceedings of International Conference “Events and Place Making”, Sydney: Australian center for event management.
- Kim S. S. and Morrison M. A. (2005). *Change of Images of South Korea among Foreign Tourists after the 2002 FIFA World Cup*, Tourism Management, 2005.
- Marzano, G. and Scott, N. R. (2006). *Consistency in Destination Branding: The Impact of Events*. In: Dr C. Arcodia, Global Events Congress and Event Educators Forum. Brisbane, Australia.(196-205). 27-29 September, 2006.
- Masterman G. and Wood E. H. (2006) *Innovative Marketing Communications: Strategies for the Events Industry*. Oxford: Elsevier, Butterworth Heinemann.
- Middleton V. T. C. and Clarke J. ( 2001). *Marketing in Travel and Tourism*, Oxford: Elsevier Butterworth Heinemann.
- Prentice R. and Andersen V. (2003). *Festival as Creative Destination*, *Annals of Tourism Research*, Volume 30, Issue 1, January 2003, p. 7–30.
- Roche, M. (2006) *Mega-Events and Modernity: Olympics and Expos in the Growth of Global Culture*. London: Routledge.
- Smith M. K. (2009). *Issues in Cultural Tourism Studies*, London: Routledge.
- Smith, H. (2006). *How the Olympics spurred Greece to break its Economic Records*, The Observer.
- Sportbusiness.com, European Economy to Receive €14 Billion Boost from UEFA EURO 2008, (URL: <http://www.sportbusiness.com/news/163041/european-economy-to-receive-1-4-billion-boost-from-uefa-euro-2008>, 10.08.2012.).
- Wise, P., Hoping to score more away goals, (UR: <http://courses.wcupa.edu/rbove/eco343/040Compecon/Europe%20West/Portugal/040608report3.txt>, 10.08.2012.)

# STRATEGIC IMPLICATIONS OF INTERNET MARKETING PLAN

Milan Kocić<sup>1</sup>

Srđan Šapić<sup>2</sup>

Velida Kijevčanin<sup>3</sup>

**Abstract:** *In order to exploit opportunities and to achieve competitive advantage, company should seriously work on defining of Internet marketing plan. Namely, competitive advantages tend to survive briefly on the Internet, especially since it facilitates the process of cross-monitoring companies. Companies, still, insufficiently understand the need and obligation to form an Internet marketing plan, because this medium is viewed just like one more marketing channel for transmitting a message, not as a sophisticated new way of doing business. It is often created as a part of a business plan, but it may be constituted in a form of in detail elaborated individual document.*

**Keywords:** *Internet marketing, Internet marketing plan, integrated communication, Internet strategy, WEB site*

## Introduction

In contemporary marketing environment, which characterizes use of aggressive media, each company leads in a constant battle for customers who have more and more knowledge and completely individualized requirements. The biggest achievement result from the Internet application in business is completely turning to customers and their needs. Understanding customers and their needs, and in accordance with that setting up a quality presence on the Internet, is the only correct way of business communication in an online environment. Achieving interactivity with the customer is one of the most important and at the same time the most difficult goal of company presence on the Internet.

As this is a relatively new medium, and many companies are developing strategies for the first time, it is necessary to consider many factors of long-term significance, which will contribute to the successful implementation of the Internet.

One of the most important strategic decisions of the company is to establish the necessary degree of commitment of managers and directors to the Internet. If there is no relevant information about that, it will be very difficult to focus the efforts of professionals who are involved in preparation and implementation of Internet marketing plan and Internet strategy.

Planned and organized Internet marketing campaign with rotation through different target sites may result in traffic and faster sales than in the case of independently observed web browser. Small-scale study, solid knowledge of target users, and correctly formulated marketing strategy is necessary. After strategy creation, the focus is on the implementation of Internet marketing plan. Internet marketing plan is a short term operational planning tool that presents in a detail procedure for implementing activities related with creation of the site content and contributes to linking this media with the other forms of marketing communication. Seybold offers eight steps for implementation of Internet plan (Chaffey et al., 2000).

---

<sup>1</sup> Faculty of Economics, University of Kragujevac, milankocic68@yahoo.com

<sup>2</sup> Faculty of Economics, University of Kragujevac

<sup>3</sup> Department of Economic Sciences, State University of Novi Pazar

### Defining the potential target audience

In the order to create a successful website, company should be completely dedicated to marketing activities related with identified needs of the target market. Defining your customers is very important for some company. Depending on the specific economic sector in which the company operates and its ambitions in the field of Internet marketing, the way of viewing ideal target marketing will also vary. It is necessary to focus on those customers that have the greatest impact on the profitability of the company. In this sense, was made the following classification of customers:

1. *The most profitable customers.* It is necessary to provide special treatment for the 20% of the most profitable visitors.

2. *The biggest buyers.* In order to provide better services for these customers and to increase their loyalty could be initiated the developing process of Extranet.

3. *Customers who are difficult to be served with other media.* Companies from insurance area can, for example, use presentations thought the Internet for the purpose of attracting the younger representatives of the audience (in year 2009. 675.000,00 active facebook users in Serbia were registered).

4. *Customers who are not loyal to the brand.* These customers can be motivated by offered incentives, attractive promotional content and creatively designed services (those who visit the site of handcrafted shoe stores, draw the story about the history of shoe production, while the fashion magazines can be found on the perfumery sites).

5. *Customers in function of decision-maker.* Site should provide such information, which will accelerate and increase the quality of decision-making process.

The consumer's behavior on the Internet is very complex and is linked to the participation of the web technology. Communication 'one on one' provides the benefits of great importance for consumers, which are not present in many other aspects of marketing activities. Site can be updated at any time, and that is way to have valid information, which is crucial for the customer's satisfaction. By providing content and services on the site which are consistent with the different characteristics of the audience, the company demonstrates its full-focused market orientation.

The very important measuring tools are conversation rates. Company must know what is necessary to measure, because there are lots of different things for measuring: sales orders, subscribers, download of e-books from site. For example, you may have 1000 hits of your site, 14 clicks, and only one sale in a day, so your conversation rate is when you divide 14 clicks with 1 sale per day, and it is 7,1% (*Small business:Canada 2012*, <<http://sbinfocanada.about.com>>)

### The integration of networks

After defining the target audience it is necessary to revise the roles of the Internet, Intranet and Extranet in order to provide detail information about specific types of customers. At the same time, aim of the aforementioned control is to eliminate any possible double content, which contributes to the saving of the marketing efforts. Often the question is why is it necessary to use two customers' support systems, as one is quite sufficient for the proper informing of the employees and customers.

In the context of this issue Bickerton indicates need for recognizing concepts of using the web site: (Bickerton et al., 2000)

- *The presentation* represents placement of static information through the site. Some authors use the term 'brochure' of the site, suggesting on permanence of these content.



- *The interaction* includes communication methods with customers such as the interactive forums and e-mail.
- *The representation* occurs when the Internet began with servicing customer in those areas were, otherwise dominated manual work. For example, banks conduct transactions with customers by utilising online service. On presented figure there are three alternative strategies which companies can implement in the process of combining the potential concepts of the web site and the Internet, Extranet and Intranet usage.

In the Figure 1. there are shown different strategies for different types of Internet servies.

**Figure 1. The potential options for the development of different types of Internet services**

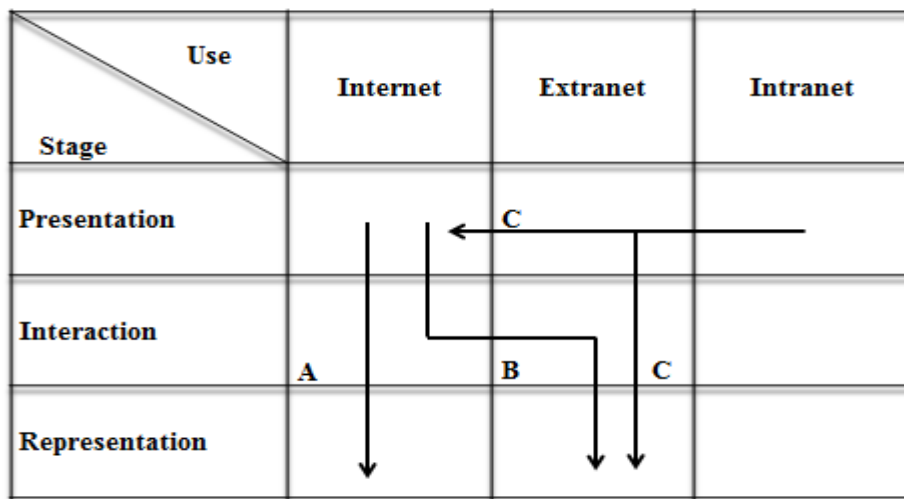

Source: Bickerton, et al., 2000

*Strategy A* is applied by many small companies which have a site in the form of an online brochure (concept of the presentation). Marketing plan may, after 6 months from the launching of the site content, initiate the concept of interaction in the form of an application that will generate feedback. After approximately 18 months, the site may be re-launched with aim to include the possibility of representation as in the case of the online sales and customer service.

*Strategy B* is typical for large companies which are engaged on the presentation and concept of interaction, and they usually offer the representation opportunities to their large customers. If the Extranet is offered, with a special code of entry, then it is automatically case of the services differentiation process.

Finally, *the C strategy* should be followed when a company has a large amount of the information available on the Intranet. Depending on the needs, this information may be transmitted to customers via the Internet or Extranet. Strategy C is generally followed by the companies with a significantly technological note.

### **Defining extend of the Internet marketing communications**

The internet marketing plan should clearly define the promotional activities which are essential for attracting customers to visit the site. At this stage it is necessary to consider how to integrate the online methods of communicating with customers with offline methods. It is important to attract the attention of visitors, make them to stay on the website and give them a reason to come back again.

Some studies have found that the initial impression is gained in the first four seconds (Zimmerman, 2007). This range of time is not enough for the user to read the content. The time is sufficient only for registering the color, layout of the content, design and perhaps the title. Therefore, fonts, pictures, activities and other important components of the site must be correlated with the expectations of the target public. It is unwise to put the lively colors on the site which sells ash urns or pastel colors on the site which focuses on teenagers. The site which sells luxury goods to exclusive clients, should contain enough space for the impression of width and extravagance, while the sites which offer a significant discount achieve success if they are 'overwhelmed' with photos. Therefore companies must engage a designer with adequate knowledge about marketing communications.

In order to site visits had some effect on sales, the average visitor should open minimum three pages or to retain on the site for at least a several minutes. Otherwise, the site visitors would not be able to get information about company's offer. Sites that contain calls for action require reaction of the users and incorporate downloading of the content, are a real magnet for visitors. All the actions taken by the user, starting from the initial click, connect him more and more with the site and motivate him to purchase.

In a final result, the researchers show that most visitors do not make a purchase during the first search of the site. Some users put emphasis on the research of the site potential before they make decision where to purchase. Others make a comparative analysis of the sites offer and define potential alternatives. Lawrence.com, for example, offers visitors many reasons to come back to the site, starting from the short film criticism to the excellent calendar of activities of the university community. Those with late appetite can find on such sites restaurants which are open after midnight. In Serbia, for example, site *trecasmena.com* offers information about the social events in Kragujevac.

### **Defining the brand developmental phases on the Internet**

How long the brand will be successful depends on maintainability off the added values considering the actions of competitors. Brand designed according to target market it is needs to possess the following attributes: uniqueness, distinctiveness, originality and compatibility with the product attributes. The examples of brands that fully meet these characteristics are: CD Now, Car Point, Buy.com and e-STEEL. New brands on the Internet are without risk cause a damage to the existing affirmed brands. However, less than 10% of the newly launched brands are successful. Online brands should have a strong personality in order to achieve success on the Internet. The company has several options in the process of presenting brands online. If the company uses the procedure of launching or re-launching the site, it has the following choices in the field of brand identity (choices can be applied both to individual brands and the corporate identity):

1. *Migrating traditional brand online.* Surely it is about the most common approach to the brand management process. The companies with well-known brands in the real world can provide a spectacular online presentation. The sites of companies such as Ford, Disney, Orange, Coca-Cola have a recognizable brand identity which correlates with the real market identity. The only risk of the online presented existing brands is the potential danger of reducing the brand value, if the site is of poor quality viewed through the performance, structure and informational contents.

2. *Extending of the traditional brand.* Some companies prefer to create slightly different versions of their brands when designing the Web sites. Companies that have distinctive characteristics should use this comparative advantage for both the online and offline promotions. Aaker warns that the problems may occur with the site recognition and the decline of the trust in the brand. This can happen if a company has a poor quality of site with low speed loading, and in a situation when a company does not respond to incoming e-mail messages. (Aaker, 1990)

3. *Partnership with the existing digital brand.* It is possible that the company promote its products through association with strong digital or Internet brands like Yahoo, Freeserver or Line One. For example, facebook as a new sociological network incorporates approximately half a billion users, which is approximately the total population in the U.S., Germany and Japan (*Vesti Aladin, 2012*, <<http://vesti.aladin.info>>).

4. *Creation of a new digital brand.* In certain situations there is a need to create a completely new digital brand, especially if the existing offline brand has a negative connotation, or if it is too traditional for the new media. Egg is a typical representative of the original digital brand. The banking service, which is an integral part of the Prudential, accepted an entirely new approach of creating brand which is separate from the parent company, with the intention to preserve the achieved level of global image and to capture new market segments.

### **Strategic partnerships**

The marketing plan describes how should be created relations with other companies in order to maximize the Internet potential. Partnerships may take different forms, starting from pure contractual arrangements where the company pays competent peoples to design a site, to the partnerships where there are no financial transactions (for example, if the company provides a reciprocal link from the site of another company). The partnership enables the exchange of skills and experience in order to successful use the Internet. The next section of the text provides an overview of some common types of partnerships:

- Partnership based on the use of design services.
- Promotional partnerships. This form of business cooperation is motivated by the desire of media and advertising networks owners to speed up the traffic to the company's website. The partners can also provide information about customers or to place information to clients about properties of the products.
- Reciprocal promotion. Here promotion is done through another site in exchange for the opponent's brand promotion, which is the so-called 'co-branding'. Exit festival and Erste Bank, appear crosswise on online and offline promotional materials.
- Distributional partnership. The partnerships built on the foundations of trust and traditionally good relations with distributors are the key for business success and a basic assumption for the elimination of all potential conflicts in the channels of distribution and promotion.
- Partnership with suppliers provides an opportunity to improve the quality of offer in accordance with the expressed expectations of the target audience.
- Legal advices. There are two possibilities, one is to use existing legal services, and other is to hire some company specialized for Internet marketing plan.

In some cases it is necessary to provide additional resources (i.e. outsourcing) for the development and promotion of the site, because companies often do not have enough staff with appropriate skills or do not have as much time as these activities require. Through outsourcing it is possible to achieve many savings, while it is certainly the most important resulted from elimination of

## **STRATEGIC IMPLICATIONS OF INTERNET MARKETING PLAN**

---

selection costs and costs of education of the new staff for these tasks. The main types of the companies or groups that can provide consultancy services for companies are:

1. In - company (marketing department). It is possible to realize each phases in the process of building the Internet presence within the company, but given the fact that it is a relatively new medium, it is likely that the employees do not have enough experience, skills or time necessary for this job.
2. The traditional advertising agency. Competences of these agencies are very diversified, they have gained reputation in the field of application of the traditional media and the new service includes web support.
3. The new media agencies. Agencies have a good composition of the technical staff, graphic designers and strategists who can meet the specific requirements of the Internet as a new marketing media.
4. Department of Information Technology. This department employs a staff with different relevant skills for the site development. However, it is possible that staff insufficiently understands the essence of business so it is unable to develop a site focused on the wants and needs of the consumers. Large companies form teams to create website, composed of experts from different business areas.
5. Management/Information Technology Consultants. If it is assumed that in the future Internet will have a major impact on companies operations, then it is necessary to constantly invent new forms of managing and integrating all relevant activities that determine the quality of the site.

The agency services are used in the initial stages, for the creative design of the site. In later stages companies use their own resources to develop the Internet marketing strategies. In fact, any serious company wants to independently develop the key elements of the strategy.

If companies do not know the laws of the countries they export to, it can lead to very negative consequences. For example, Germany has a law that explicitly prohibits comparison of products, and Belgium a law under which the discounted sales may be conducted in January and July. Companies often seek legal assistance for the following typical areas of activity:

- Registration of name and trademark for new Internet brands. There are many discussions over how to regulate the ownership of some key elements of the trademark.
- Advertising standards. Many countries have specific laws that prevent disclosure of false information through advertisements and limit the possibility of unfair competition.
- Defamation. The information published on the sites, which are directed to criticism of staff or products of other companies may be characterized as defamation.
- Copyright and intellectual property rights. Copyrights protect creative work in any form - in the form of text, photograph, graphics, audio and video materials - from potential abuse. Copyright law protects, primarily, not the designers, but the individuals who hired him to produce some creative form. These laws, from the legal standpoint, totally marginalize the role of the creator. Some of the creators, usually photographers, are inclined to give limited license or insist on retaining the copyright. If this cannot be subject to negotiation, for each company is better to hire a new creative person. The company must own all the copyrights and intellectual property rights, because sometimes creators decide to withdraw from the deal.
- Protection of property and data privacy laws. Sites must be in accordance with the standards and legal principles established by the local laws. On most sites are statements for which must be given consent before downloading the content and use of services. First of all, these statements are used to protect companies from the lawsuits. In a time of concern about privacy, increasing

presence of pornography, as well as the appearance of child abuse, the presence of such approvals on the sites prevents the emergence of legal troubles for the company. YouTube.com, where visitors upload their videos, ask from users to send them report immediately if they find some offensive content. A similar site, vMix.com, employs people who work on scanning and checking the photos and videos, before posting to the site.

- Taxation of e-commerce. Companies involved in e-commerce sales charge taxes from customers.

### **Organizational structure**

When creating a new site, its design is approached within the existing structure of the company, with the use of outsourcing for scarce resources. With the increasing site contributions to overall company operations, its diversification increases, and it is necessary to access the planning of new structures for the Internet marketing. There are four typical stages of development:

1. *Ad-hoc activities.* At this stage the degree of integration between online and offline marketing communication is very low. Site maintenance is on an informal basis so the errors often occur due to lack of timeliness of information.

2. *Focusing efforts.* Within this phase it is necessary to introduce a control mechanism of the Internet marketing which is usually in the form of steering group composed of experts in field marketing, informational technology, design and law.

3. *The formalization.* At this stage the Internet reaches a critical mass, which provides possibility of defining groups or separated business units which will manage with digital marketing.

4. *Institutionalization of capabilities.* This phase also includes group of activities, but in the contrast to previous, by formal links that are created between the digital marketing and the core company activities. Baker insists on the implementation of restructuring, in order to within the separate service for the electronic shopping provide the necessary service levels to customers over the Internet, especially in a situation where the existing processes or structures do not allow it (Baker, P, quoted by Chaffey et al., 2000). Small and medium companies have marketing departments which are constituted of only a few experts, so they do not practice the formation of separate groups. Many large companies consider unnecessary involvement of individuals or small groups responsible for Internet marketing. Over 75% of companies in the UK were against the constitution of separate departments for electronic sales.

The Cyber Source claims that the online stores in the United States and Canada have lost over \$ 2.8 billion in online purchases in 2005<sup>th</sup> year (about 1.6% of the total online sales). This suggests that the companies should seriously consider investing in special departments of Internet marketing.

### **Budgeting**

Before appearing on the Internet, a detail cost calculation and budgeting is required. Companies that debut on the Internet have to count on the costs of creation, maintenance and costs of initial promotion of the site. Key indicators of success are customer acquisition cost, the turning point and the return on investment.

Companies can effectively manage the costs, related to the Internet marketing, if they periodically (annually or every two years) perform a comprehensive audit or re-launching of the site. These changes tend to be more frequent during the initial phase of the site, and after that is coming gradual stabilization with less frequent changes and re-launching.

## **STRATEGIC IMPLICATIONS OF INTERNET MARKETING PLAN**

---

Bayne proposes several methods for estimating the current costs that affect the amount of Internet marketing budget (Bayne, 2000)

1. Last year Internet marketing budget.
2. The percentage of company sales.
3. The percentage of total marketing budget. The company starts with a relatively low amount, which gradually increases with the growing influence of the Internet.
4. Reallocation of the marketing dollar (RSD). In order to increase spending on the Internet marketing it is necessary to reduce expenditures for other media. Bayne points out that this is a risky activity, because if the Internet marketing does not achieve the expected results it will be seen as a bad investment, which will indirectly affect the other media due to reduced spending.
5. The comparison of own amount for allocation with the expenditure of companies in the same economic activity. If the company disposes with such knowledge it will be able to timely respond to the threats of competitors. In some cases there is a danger to react hastily to unrealistically formed budgets of the rival companies. There is also possibility of large variations in the reliability evaluation of the rival site quality.
6. Creation of an effective online presence. Some companies use the approach „to allocate the maximum possible amount for the site development” which leads to irrational use of funds for the purpose of achieving its objectives. On the other hand, for the activities on which the Internet has a significant impact, this can be a very wise option.
7. A multistage plan associated with the defined goals and past achievements. This situation implies that the current existing programs are designed so that the level of the investments for each year is determined by the defined objectives and results achieved in similar, previously realized projects.
8. A combination of approaches. Because the initial constructed budget is based on various intangible elements, it is best to use several methods which will contribute to the corresponding of the invested funds level to the defined objectives.

The most site maintenance procedure costs about 50% of the total cost of site creation. This amount depends on the nature and types of updates, as well as the applied technology for the needs of the automation process. Most of the site content changes are related to the actualization of product specifications and the price height. The web site maintenance costs can be lowered significantly below 50% if the management process is well-organized.

For the purposes of promoting the website address is commonly used existing forms communicational forms of the company, such as the printed or television advertisements. This approach suggests that a very small proportion of development costs drop off the site promotion. However, for directing the desired number of customers to the site, it is necessary to set up advertisements that are very specific for the users of the Internet technologies (for example, investment in banner advertising or sponsor sites whose content is linked to the site of the observed company).

One of the key factors for achieving success in the Internet marketing, as with other projects, is support of the company's top management. Baker conducted the research with an aim to determine the level and nature of the management impact on the development and profitability of the site (Baker, P. quoted by Chaffey et al., 2000). The results clearly indicate that those companies where the use of the Internet was supported by the board of directors accomplished the best results from the aspects of profitability of the site. These companies have integrated electronic purchase in to the value chain. Marketing managers and the Internet marketing managers often lobby top management in order to explain the benefits of investing in the site, as well as highlighting the consequences of not investing.

The strategic importance of the Internet and the process of integrating of the Internet marketing into existing business need to be fully presented to the employees at all organizational levels. If it is necessary, additional training and education are conducted to the employees to better master the Internet technology.

### **Establishing the dynamics of site management activities**

It is important to register the site domain as soon as possible and thus limit the capabilities of other companies to do the same before. The schedule of activities should be structured as follows:

1. *The pre-developmental tasks* (domain registration, the decision to host the site and to prepare concise site goals).

2. *The content planning*. At this stage it is necessary to conduct a comprehensive analysis of the factors which determine the success of the site, define the site design and access to development of the site prototype.

3. *Development and testing of the site content*. This stage is realized by creating the HTML page, creating accompanying graphical images and testing other key contents of the site.

4. *Site publishing*. This phase includes a small number of activities that are conducted routinely due to successfully realized previous actions.

5. *The promotion prior to launching*. This activity is realized using advertizing materials that suggest visiting the website or through banner advertising. Site should be registered at different search engines.

6. *Current promotion*. The schedule of activities includes both periodic and discount promotion, which is usually performed on a monthly basis.

### **Conclusion**

The application of the Internet technology provides a dramatic improvement of business success and the strategic position of the company. A radical reduction in prices of the key factors of production, as a result of innovation, contributes to the increase in productivity. In this context, it can certainly be argued that the Internet, as one of the most striking global phenomena in the field of new technologies, contributed to these unprecedented success of the direct marketing activities. It is a fact that the use of the Internet does not guarantee the generating of the competitive advantage, but if it is used to support the traditional way of conducting business, it certainly leads to higher profit and better strategic position. The application of the Internet highlights the impact of the proper strategic choice of direct marketer on the future position of the company. Companies are best differentiated in relation to the competition, precisely with an adequate marketing strategy performance, organization, functioning and promotion of their business through the site. Today the Internet is one of the fastest ways to improve the operational efficiency of companies, but this is not a sufficient condition for gaining the competitive advantage. Namely, in order to achieve competitive advantage it is necessary to provide conditions for the integration of traditional and Internet methods into business. The profit is not gained from the Internet only in those cases where the expectations were unrealistic or its role was not properly defined in the Internet Marketing plan. For the success in the Internet marketing planning of crucial importance is coordinated action of company's IT department and marketing experts.

### References

- Aaker D. (1990), "Brand extensions: The good, bad and the ugly", *Sloan Management Review*, Vol. 31, No 4, pp. 47-56
- Bickerton P., Bickerton M., Pardesi U. (2000), *Cybermarketing: how to use Internet to Market your goods and services*, 2<sup>nd</sup> edition Oxford, Butterworth Heinemann, London
- Bayne K. (2000), *The internet marketing plan: the complete guide to instant web presence*, Wiley Publishing; 2<sup>nd</sup> edition, New York
- Baker P. *Electronic commerce*, Research Report, quoted by Chaffey D., Mayer R., Johnston K., Ellis F. (2000), *Internet marketing: strategy, implementation and practice*, Financial Times Management, p. 149.
- Chaffey D., Mayer R., Johnston K., Chadwick F. K. (2000), *Internet marketing: strategy, implementation and practice*, Financial Times Management
- Zimmerman J. (2007), *Web marketing for dummies*, Wiley Publishing, Inc., Indianapolis, Indiana
- Small business: Canada* (10 april 2012) < <http://sbinfocanada.about.com> >
- Vesti Aladin* (12 april 2012) <<http://vesti.aladin.info>>



# EMPIRICAL INVESTIGATION OF BRAND ORIENTATION IN THE NON-PROFIT SECTOR

Marija Mandarić<sup>1</sup>

Dejan Sekulić<sup>2</sup>

Nemanja Pantić<sup>3</sup>

**Abstract:** *Brand orientation is a relatively new marketing concept. It has found the implementation in different types of commercial and non-profit organizations. The existence of a brand orientation approach in organizations enables a better implementation of brand management activities. Brand can be a source of competitiveness and that is why the brand management is an important marketing concept. Nowadays, the increasing role of brand management is a consequence of changing business patterns, and especially of the new consumer's role in organizational results. Many researchers have recognized the influence of brand orientation on the business performance. The goal of this paper is to highlight the fact that creating a strong brand and formulating effective brand strategy needs organization members to be oriented towards the brand. The study presents the results of empirical research in non-profit sector in Serbia.*

**Keywords:** *brand orientation, brand management, non-profit organisation, organisational performance*

## 1. Introduction

Faced with numerous challenges, organizations continually develop and implement new concepts in conducting business, with a goal to improve their image, both among the members of the organization, and in the general public. Strategic approach to management of the organization as a brand can significantly contribute to positive perception of quality and recognition of the organization in the market. A large number of profit and non-profit organizations have become heavily oriented to the brand-building activities, which reflected in better organizational performance.

Operating in a progressively more competitive and turbulent environment, non-profit organizations are beginning to recognize the need to become more “businesslike” and of the value of marketing in achieving a competitive advantage. Faced with competition, non-profit organization want to achieve superior position in the market. The organization becomes a brand holder and, in the process of brand creation, it is trying to make all of its members perceive it as a brand. A non-profit organization needs to constantly improve relations with its members, respect and follow the competition and coordinate between them in order to achieve better market position.

The paper includes literature review in the area of brand management, with special reference to the implementation of the brand orientation concept and branding in the nonprofit sector. It then describes the scale development process adopted and details the procedure for assessing the reliability, validity and generalizability of brand orientation perceptions. Managerial implications and applications of the scale are addressed before concluding with limitations of the approach and directions for future research.

---

<sup>1</sup> Faculty of Hotel Management and Tourism, University of Kragujevac, mmandaric@kg.ac.rs

<sup>2</sup> Faculty of Hotel Management and Tourism, University of Kragujevac

<sup>3</sup> Faculty of Hotel Management and Tourism, University of Kragujevac

### Literature Review and hypothesis development

**Organisation as a brand.** During the last decade, the brand management concept has undergone intensive development. Numerous studies related to this area and literature which keeps track of findings in practice, have resulted in great interest of businesses to implement brand management concept. Branding strategy creates original or unique recognition of a product, service, person or group of people, concept, business model, company or institution and differentiates the offer from the competition. Brand holders can be people, objects, organizations, geographic destinations, goods, services and the like. Brand is an association of a strong identity and global success regardless of the brand holder. All organized and individual activities can acquire a brand feature. All that value, attract attention, those which are superior and distinctive can and are preferred to be brand holders (Keller, 2003). Organizations often appear as brand holders and their most significant features are name, prestige and reputation. The confidence of the general public determines the strength and success of these brands. The term 'brand' in the present study is taken to apply to the organisation itself, rather than to the products/services it offers. Within the marketing literature, this falls under the umbrella of 'corporate brand image'. Corporate branding differs from product branding in the importance it places on so-called 'brand values'—that is, the values that are inherent in, or associated with, the corporation/organisation (and its products and services) (de Chernatony, 2002). Organizational or corporate branding enables building of the organization as a brand with a goal to improve the business reputation. The existence of trust towards certain organization determines the loyalty of its members. When organization is a guarantee of quality and is recognizable, then it can easily acquire and maintain competitive advantage in the market.

**Brand orientation concept.** In order to build strong brand and formulate effective brand strategy, whether it is a product or an organization, it is necessary to have a favorable business environment, which includes the existence of *orientation towards brand (brand orientation)*. The term 'perceived brand orientation' (PBO) refers to customer attitudes regarding the extent to which an organisation engages in brand-oriented activities and behaviour (Mulyanegara, 2010). The significance of the concept is reflected in the fact that brand orientation determines brand performance in the market (Wong & Merrilees, 2007). When there is a strong brand orientation, employees are dedicated to building, development and taking care of the brand, thus providing conditions for implementation of sustainable and competitive brand strategy. Brand strategy should be applied in order to accomplish business strategy goals and to provide competitive breakthrough and long-term survival in the market for the organization.

The term „orientation towards brand“ is relatively new, launched in the beginning of 90's of the last century, but quickly becoming frequently used in the technical texts and scientific researches. The purpose of the concept is to point out the internal capacities of the organization for sustainable brand building. Brand orientation concept aims to create brand which is recognizable, incorporated and favored in the marketing strategy of the organization (Wong & Merrilees, 2007). Whilst pursuing a brand orientation is intuitively logical, it also has strong theoretical support. Clark and Marshall's (1981) theory of mutual knowledge explains how individuals come to believe with great certainty that they and another share the same knowledge, beliefs or information regarding an object. From a brand management perspective, brands are likely to be more successful when an audience's perception of a brand mirrors the firm's view of the brand concept and both are identical to the consumers' original specifications (Ewing & Napoli, 2005).

Over time, numerous definitions of the brand orientation have emerged. The creator of the brand orientation concept Urde defines the brand orientation as “An approach in which the processes of the organisation revolve around the creation, development and protection of brand identity in an ongoing interaction with target customers with the aim of achieving lasting competitive advantages in the form of brands“ (Wong & Merrilees, 2008). Ewing and Napoli define brand orientation as „The organisational wide process of generating and sustaining a shared sense of brand meaning that

provides superior value to stakeholders and superior performance to the organization”, and Baumgarth as “A specific type of marketing orientation, which is distinguished by the high relevance accorded to branding by top management. It also implies a strongly systematic approach to brand management characterised by an offer that is relatively constant, consistent and relevant to the buyer and clearly differentiated from the competition” (Gromark & Melin, 2011). Different definitions of the brand orientation basically have the same meaning – motivating employees to continually promote brands owned by the company and to dedicate the entire business operations to building and maintaining of the brands. Understanding the role and significance of the brand in business operations is fundamental for its building and market success.

In addition to these conceptualizations there have also been a number of attempts to categorise brand orientation on a scale from a low to a high degree of brand orientation. The main characteristics of these operationalisations are presented in Table 1.

**Table 1: Operationalisations of brand orientation**

<i>Author</i>	<i>Key concepts</i>	<i>Comments</i>
<b>Hankinson (2001)</b>	<ul style="list-style-type: none"> <li>• Understanding the brand</li> <li>• Communicating the brand</li> <li>• Using the brand as a strategic resource</li> <li>• Managing the brand deliberately and actively</li> </ul>	Brand orientation is described as a model consisting of four elements primarily associated with organisational behaviour and capabilities.
<b>Bridson and Evans (2004)</b>	<ul style="list-style-type: none"> <li>• Distinctive capabilities</li> <li>• Functional capabilities</li> <li>• Value adding capabilities</li> <li>• Symbolic capabilities</li> </ul>	Brand orientation is described as the degree to which an organisation values brands and the degree to which its practices are orientated towards developing four specific organisational capabilities.
<b>Reid et al (2005)</b>	<ul style="list-style-type: none"> <li>• Shared brand vision</li> <li>• Shared brand functionality</li> <li>• Shared brand positioning</li> <li>• Brand return on investment</li> <li>• Brand symbolism</li> <li>• Brand value-adding capability</li> </ul>	Brand orientation is described as a model containing six elements associated with organisational attitudes and capabilities.
<b>Ewing and Napoli (2005)</b>	<ul style="list-style-type: none"> <li>• Interaction</li> <li>• Orchestration</li> <li>• Affect</li> </ul>	Brand orientation is characterized by three concepts associated with organisational capabilities.
<b>Wong and Merrilees (2007)</b>	<ul style="list-style-type: none"> <li>• Branding flows through all our marketing activities</li> <li>• Branding is essential to our strategy</li> <li>• Branding is essential in running this company</li> <li>• Long-term brand planning is critical to our future success</li> <li>• The brand is an important asset for us</li> </ul>	Brand orientation is characterised by five items capturing organisational attitudes and behaviour.
<b>Baumgarth (2009)</b>	<ul style="list-style-type: none"> <li>• Values</li> <li>• Norms</li> <li>• Artefacts</li> <li>• Behaviours</li> </ul>	Brand orientation is characterised by four concepts capturing primarily attitudes and behaviour but also artefacts which makes this operationalisation unique in comparison to the others.

Source: Gromark, J., F. Melin. 2011. “The underlying dimensions of brand orientation and its impact on financial performance”. *Journal of Brand Management*, vol. 18, no. 6, pp. 396.

When analysing these operationalisations three factors often presented as being of vital importance for successful brand orientation can be identified, namely, attitude, behavior and capabilities. The management's task is to synchronize these elements in order to generate added value for the organization and creates the loyalty of their users. It is important to emphasize that the implementation of the brand orientation concept is not limited by the organization profile, so that both profit and non-profit organizations can implement this concept with the same success.

Brand orientation is the first step in the process of creation, development and protection of the brand (organization) as a valuable resource which provides sustainable competitive advantage. Brand orientation means that the brand issues are considered critical by all members of the organization. The brand strength is recognized in business activities, employee behaviour, internal and external communication, coordination of business activities, and the significance of the concept adoption is supported by the fact that the brand (organization) cannot have greater strength in the market than the one perceived by its stakeholders. More preciously, it has been argued that an organization cannot be integrated externally without being integrated internally (Reid et al, 2005). BO creates favorable business climate within the organization and among its members, and it is the prerequisite of the successful implementation of the strategic brand management.

***Branding in the Non-profit Sector.*** Within the non-profit context, an organisation's image provides potential donors with important cues regarding the efficiency of its operations, its degree of familiarity, and its credibility (Mulyanegara, 2010). In general, however, marketing has gained acceptance among the non-profit practitioner community. It is therefore a little surprising that the efficacy of brand management in non-profit organizations has received only scant attention—particularly since the conceptual development of brand management in the for-profit sector has progressed rapidly since the latter part of the 19th century. In an attempt to address this gap in the literature, the present study focuses on the development of a scale to capture the determinants of brand orientation and brand philosophies within this sector (Ewing & Napoli, 2005). Non-profit organizations form an integral and relative large sector of many economies. With the non-profit ‘‘marketplace’’ becoming more competitive and resources becoming increasingly scarce, the principle focus for many non-profit managers is toward attracting and raising funds and establishing viable partnerships with others. It is not surprising that many nonprofits are well aware of the role marketing can play in achieving such objectives (Napoli, 2006).

### **Methodology of research**

In the course of setting the concept, goals and hypotheses, as well as in designing the empirical research, the results of foreign research played a significant role. The model from the brand orientation study, done by the professor Mulyanegara from the Swinburne University in Australia, was used for formulation of the questionnaire. In line with Mulyanegar, this study adopts scale of Tuominen et al (2009) which uses the MKTOR scale of Narver and Slater (1990) to examine the impact of three dimensions of brand orientation - perceived customer orientation, perceived competitor orientation, and perceived interfunctional coordination (Mulyanegara, 2010).

The questionnaire with closed or structured questions (statements) in the rating-scale format was used. The questionnaire includes fifteen statements (conclusions) through which latent variables were measured. The five-level Likert scale was used (from 1 (one) – absolutely disagree to 5 (seven) - absolutely agree). During pre-testing phase, it was found that five-level scale more suitable for implementation than the seven-level scale. Respondents were asked to express their level of agreement with statements in the questionnaire. In the course of designing the questionnaire, the structure of statements, that is variables, was taken into an account. In order to avoid possible misunderstanding of

certain questions by the respondents, a special attention was paid to the formulation of questions with an imperative to be clear and precise.

Having reviewed the results of the previously conducted foreign researches and starting from the perception of members of the organization in determining the brand orientation and brand building, we formulated the following research hypotheses in this paper:

- H1. Orientation towards membership is positive determinant of the perceived brand orientation*
- H2. Orientation towards competition is positive determinant of the perceived brand orientation*
- H3. Interfunctional coordination is positive determinant of the perceived brand orientation*

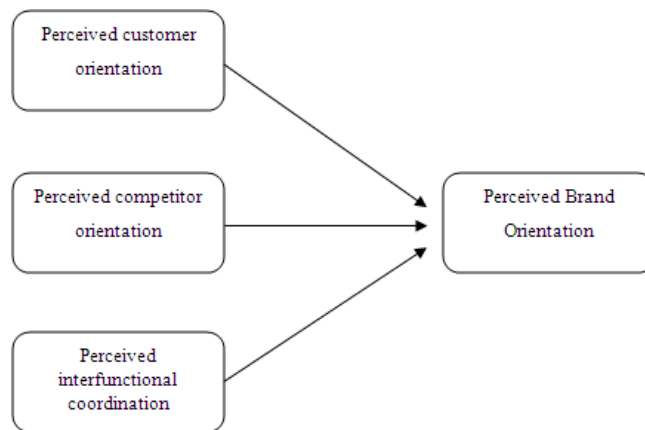

**Figure 1: Proposed research model**

The figure illustrates the initial assumptions on the relation between the perceived customer orientation, perceived competitor orientation, perceived interfunctional coordination and perceived brand orientation. The research model was tested in the non-profit sector in Australia (Mulyanegara, 2010). The research examined the attitudes of members of church organizations in Australia. The research plan, within our empirical research, defined the target group which included legal entities – tourist agencies, members of the non-profit organization Yuta (National association of tourist organizations).

The research was conducted among the users of services (tourist agencies) provided by the non-profit organization Yuta, starting from the assumption that they have necessary information on organizational performances of Yuta and actively follow its marketing activities. There are several reasons for researching a non-profit organization:

1. Non-profit or nongovernmental organization is a very “broad“ term. The term "nongovernmental organizations", was used for the first time in Serbia in 1874, in the magazine called "The voice of the public". Since that time, the nonprofit sector in Serbia has gone through several phases, from groups and associations founded under the sponsorship of Serbian Orthodox church and the royal family, citizens' associations controlled by the state in the socialist period (so called "governmental" nongovernmental organizations), to contemporary

nongovernmental organizations with wide variety of goals. Non-profit sector includes organizations whose primary business goal is not making profit, however these organizations can have significant impact on economic trends. Considering the development of tourism in our country in recent years and growth of income, we selected the non-profit organization which represented the support to development of tourist activities.

2. The experiences of foreign researches are in favor of this selected segment for research. Australian studies on brand orientation in the non-profit sector were the starting point for the selection of target segment. The unique feature of this research is the fact that Yuta is the market leader and that the users of its services are tourist agencies, a not persons.
3. Tourist agencies – members of Yuta, are characterized by a significant level of trust and recognition in the public, which create an assumption for brand orientation and implementation of brand management principles. The research included the most vital part of tourism industry.

After deciding on target group selection and questionnaire structure, the conditions were met to start distributing questionnaires. The research was conducted by using e-mail surveys. The E-mail survey is frequently used technique in modern marketing research. Since the respondents were legal entities (tourist organizations), it was presumed that these respondents had computer skills and that they regularly checked their electronic mail. E-mail surveys enable speed in data collection, while their application eliminates any possible influence of interviewers on the attitudes of the respondents. The costs of the implementation of the e-mail survey are far lower compared to the personal or telephone interviews.

Prior to distribution of questionnaires, e-mail addresses of Yuta members participating in the research were registered. Thus, quick and efficient sending of questionnaires was enabled. In cases where information (e-mail address) was not available through internet search, e-mail addresses were provided by telephone. The questionnaires were distributed to the members of non-profit organization Yuta in the course of ten working days from May 28 to June 08, 2012. In the course of sending questionnaires, the receipt confirmation option was activated, which contributed to making better records of movement and delivery of questionnaires. Out of practical reasons (invalid e-mail addresses, changes in job organizational charts, delegating responsibilities and the like), the questionnaire was sent once again to certain organizations. The completed questionnaires were collected in the period from May 28, 2012 to June 22, 2012. Data on received questionnaires and results of the research are presented in the following part of the paper.

### **Resultats of the empirical research**

#### ***The characteristics of the sample***

The research on the perceived brand orientation of Yuta was conducted based on data provided by forty-nine (49) tourist agencies. The questionnaires were sent to official e-mail addresses of all two-hundred-sixty-eight (268) members – tourist agencies from the list available at the official Yuta website ([http://www.yuta.rs/sr/yuta/turisticke\\_agencije.asp](http://www.yuta.rs/sr/yuta/turisticke_agencije.asp)). The list includes basic information on tourist agencies (name, company headquarters, website address).

The total number of received and fully completed questionnaires is forty-nine (49), which makes the response rate of 18,3%. The response rate is adequate and satisfactory compared to other studies conducted among corporative respondents (Hart, 1987; Wong & Merrilees, 2008). In the other Australian study, the response rate is 18% (Wong & Merrilees, 2008), German researchers thought that the response rate of 14% (Burmam & Zeplin, 2009)

is adequate, while the researchers from Korea even had much lower response rate (Lee et al, 2008) in the study which included the survey of businesses.

**Reliability**

Internal consistency of statements was measured by values of coefficient Cronbach’s alpha. The coefficient alphas for the respective constructs were calculated using the reliability procedure in SPSS (SPSS 17). Cronbach (1951) argues that values of this coefficient range from 0 to 1, where it is considered that values higher than 0.7 point to adequate reliability and consistency (Chen & Hua, 2005). The table 2. shows values of coefficient Cronbach’s alpha for latent variables in the model. As can be seen in the table, the reliabilities of all constructs in this research fall within the excellent level.

**Table 2: Model variables**

Latent variables	Statements	Cronbach’s alpha
<b>Perceived customer orientation</b>	National association of tourist organizations - Yuta constantly recognizes the needs of its members (tourism organizations / agencies). Services provided Yuta tailored to the needs of its members. Yuta tries to fulfill the expectations of its members.	<b>0.89</b>
<b>Perceived competitor orientation</b>	Yuta monitors the activities of competing associations and improve the quality of service delivery. Yuta is aware of the existence of other competing associations. Yuta provide better services than competing associations	<b>0.80</b>
<b>Perceived interfunctional coordination</b>	Yuta encourages members to engage in organisation activities. Yuta understood that the various activities and events can provide more value for members. Members of Yuta cooperate (share resources/information).	<b>0.74</b>
<b>Perceived brand orientation</b>	Tourism organizations become members of Yutu because of its reputation. Yuta has unique values that are recognizable to the public. Yuta is a well-known in the tourism market. Different promotional activities send consistent messages about Yuta in the tourism market. Activities/programs implemented by Yuta have a major impact on final users of tourist services (tourists). Promotional activities Yuta create a positive image among its members.	<b>0.85</b>

Source: Internal (field) research

Values of the coefficient Cronbach’s alpha for perceived customer orientation, perceived competitor orientation, perceived interfunctional coordination and perceived brand orientation are 0.89; 0.80; 0.74; 0.85, respectively. The received values point to adequate reliability and internal consistency of manifest variables. Cronbach’s alpha for the whole model is 0.91.

***Presentation and discussion of results***

Descriptive and analytical statistical methods in SPSS (SPSS 17) were used to process collected data. Through application of descriptive statistical methods in analysis of data received from 49 tourist agencies (members of the national tourism association Yuta), minimum and maximum values, mean values and standard deviation were obtained. The table 3. shows results of descriptive statistics.

**Table 3: Measures of descriptive statistics**

Variables	N	Min	Max	Mean	Std. Deviation
Perceived customer orientation	47	2.00	5.00	4.00	0.97
Perceived competitor orientation	47	1.33	5.00	3.86	0.92
Perceived interfunctional coordination	47	2.33	5.00	4.02	0.77
Perceived brand orientation	47	2.67	5.00	4.06	0.66

*Source: Internal (field) research*

Based on the data from the table, the highest value of mean, characteristic for brand orientation can be determined (4.06). The lowest evaluated model variable is perceived competitor orientation (3.86). This result can be explained by the fact that Yuta is strongly recognizable and has a privileged position in the market. In addition to Yuta, the only other association of tourist organizations is ANTAS, since 2010. Tourist agencies perceive Yuta as the organization which is strongly oriented towards building its own brand. The lack of competition almost causes Yuta's monopoly in the market and weak competitor's activities orientation. Low values of standard deviations indicate homogeneity of respondents' attitudes regarding all four variables of research model.

The table 4. shows the results of correlation analysis and based on the value of the Pearson coefficient, the degree of dependance between variables in the model was determined.

**Table 4: Correlations**

Variables	1	2	3	4
Perceived customer orientation	1.00			
Perceived competitor orientation	0.755**	1.00		
Perceived interfunctional coordination	0.681**	0.750**	1.00	
Perceived brand orientation	0.685**	0.769**	0.726**	1.00

\*\* Correlation is significant at the 0.01 level (2 tailed)

*Source: Internal (field) research*

If we take stricter criteria and assume that values of the Pearson coefficient mean: 0.2 to 0.4 – weak correlation, 0.4 to 0.6 – moderate correlation, 0.6 to 0.8 – strong correlation, we can conclude that there is high degeree of linear correlation between latent model variables.

Table 5. shows the result linear regression. The impact of three independent variables on dependent variable “perceived brand orientation“ was tested.



**Table 5: Multiple regression analysis results (dependent variable: perceived brand orientation)**

Variables	$\beta$	t	Significance
Perceived customer orientation	0.163	1.176	0.246
Perceived competitor orientation	0.422	2.747	0.009**
Perceived interfunctional coordination	0.298	2.166	0.036*

Significant at  $p < 0.01$  (\*\*)  $p < 0.05$  (\*)

Source: Internal (field) research

Based on the results of the regression analysis, significant impacts of two variables were confirmed: perceived competitor orientation and perceived interfunctional coordination. It can be concluded that perceived competitor orientation has statistically more significant impact on dependent variable perceived brand orientation (coefficient  $\beta = 0.422$ ,  $t=2.747$ ,  $p=0.009$ ) compared to variable perceived interfunctional coordination, which has somewhat weaker, but also significant impact (coefficient  $\beta = 0.298$ ,  $t=2.166$ ,  $p=0.036$ ). Perceived customer orientation is not statistically significant factor. Based on the results of the regression analysis, initial hypotheses H2 and H3 can be confirmed. Hypotheses H1 can not be confirmed. Coefficient of determination is ( $R^2$ ) 0.653 which means that 65.3% of variability “perceived brand orientation” was described by variables: customer orientation, competitor orientation, and interfunctional coordination.

### Conclusion and managerial implications

Brand orientation represents new marketing concept which can be implemented in different organizations. Similar study which investigates attitudes and perceptions of members of a non-profit organization on brand orientation of that organization has not been yet conducted in Serbia. The research determined the factors which create perception of members on organization's brand orientation. Incorporated variables in research model are elements which should be carefully analyzed in the course of building organization as a brand.

Research results have shown that there is strong correlation between research variables in the model (perceived customer orientation, perceived competitor orientation, perceived interfunctional coordination and perceived brand orientation). However, members' perception of organization's brand orientation is significantly influenced by perceived competitor orientation and perceived interfunctional coordination. There is an explanation for the received results.

Motivation of tourist agencies for joining Yuta is rational (Yuta reputation, market recognition, tourist trust and the like.). Relationship between Yuta and tourist agencies does not affect significantly their perception of Yuta brand orientation. The long tradition and trust of end users of tourist services in Yuta differentiate Yuta in the market and make it recognizable brand. Yuta, while not paying enough attention to the competition, due to the privileged position in the tourism market, must be aware of the importance of the competition factors. In the future, through emergence of new competing associations or expansion of activities of the existing associations in tourism industry, Yuta's position may be compromised. The emergence of competition will make its relationship to membership become crucial for its strong brand reputation. The possibility of business cooperation, good relations between Yuta members, exchange of knowledge and experience contribute to better perception of Yuta brand orientation.

The survey of Serbian tourist agencies' attitudes shows that there is a large space for improvement of business cooperation between Yuta and tourist agencies. Thus, satisfaction of the end

users of tourist services can be improved as well. According to the results of the research, there is a sufficient awareness on importance of the brand management and brand orientation concepts in tourist agencies. It is necessary that Yuta builds better relationship with its members in order to acquire sustainable competitiveness in the long term.

### Limitations and future research

The conducted study has several limitations. First, the research was conducted on the sample consisting of the members of the non-profit organization Yuta, so the results are not representative at the level of the entire non-profit sector in Serbia. In the future, it would be useful to examine attitudes of members (service users) of other non-profit organizations as well.

Second, orientation to membership can determine membership perception of brand orientation. If the research included members of some other non-profit organization, due to various factors (corporate respondents, end users of services, motives for belonging to the organization: personal and business, beliefs, obligation, etc.), the results could be different. It is very likely that there are significant differences in attitudes to brand orientation for members of different organizations.

Third, the subjectivity of respondents in the survey. The research focused on the perceptions of tourist agencies' representatives which are not always objective. Certain respondents make conclusion based on their current impression (last contact with Yuta representatives), and not based on the whole experience. The research was conducted during the time of year when employees are under big pressure due to seasonal workload and it is possible that stress reflected in their assessment of the statements.

Fourth, small sample does not allow application of statistical methods from the foreign research. Therefore, and due to the specific target group, results of the foreign research and the results of this conducted research are not comparable.

Some future research can include different non-profit organizations. The perceptions of two segments can be especially investigated and compared: members of the non-profit organizations – persons, and members of the non-profit organizations – legal entities. It would be useful to test the model in both categories of membership and compare results. It is desirable to test the model in different categories of non-profit organizations and to investigate reasons for potential differences in obtained results. It is possible to describe latent variables from the research model through larger number of statements, provided it is determined that they can be integral components of the model.

### References

- Burmann, C., Zeplin, S.. (2009). Key determinants of internal brand management success: An exploratory empirical analysis. *Brand Management*, 16 (4), 264-284.
- Chen, C. C., Hua, N. (2005). The Effect of Investment in Technology Diffusion within a Firm on Market Competitiveness. *International Journal of Management*, 22 (1), 142-153.
- Gromark, J., Melin, F.. 2011. "The underlying dimensions of brand orientation and its impact on financial performance". *Journal of Brand Management*, vol. 18, no. 6, pp. 396.
- de Chernatony. 2002. Would a Brand Smell any Sweeter by a Corporate Name? *Corporate reputation Review*, 5(2-3), 114-132.
- Ewing, M. T., Napoli, J. (2005). Developing and validating a multidimensional nonprofit brand orientation scale. *Journal of Business Research*, 58, 841-853.

- Hart, S. (1987), The use of the survey in industrial market research, *Journal of Marketing Management*, 3(1), 25-38.
- Keller, L. K. (2003). *Building, Measuring and Managing Brand Equity*. Pearson Education, New Jersey.
- Lee, J., Park, S. Y., Back, I., Lee, C. S. (2008). The impact of the brand management system on the brand performance in B-B and B-C environments. *Industrial Marketing Management*, in press.
- Mulyanegara, R. C. (2010). Market Orientation and Brand Orientation from Customer Perspective an Empirical Examination in the Non-profit Sector. *International Journal of Business and Management*, 5 (7), 14-23.
- Napoli, J. (2006). The Impact of Nonprofit Brand Orientation on Organisational Performance. *Journal of Marketing Management*, 22, 673-694.
- Reid, M., Luxton, S., Mavondo, F. (2005). The relationship between integrated marketing communication, market orientation and brand orientation. *The Journal of Advertising*, 34(4), 11-23.
- Wong, H. Y., Merrilees, B. (2007). Closing the marketing strategy to performance gap: the role of brand orientation. *Journal of Strategic marketing*, 15, 387-402.
- Wong, H. Y., Merrilees, B. (2008). The performance benefits of being brand – oriented. *Journal of Product & Brand Management*, 17(6), 372-383.
- [http://www.yuta.rs/sr/yuta/turisticke\\_agencije.asp](http://www.yuta.rs/sr/yuta/turisticke_agencije.asp) (17.05.2012)



# **GLOBALIZATION AND REGIONALIZATION**



# POST-CRISIS STRUCTURAL IMBALANCE – THE CASE OF SERBIA

Edvard Jakopin<sup>1</sup>

Mirjana Knežević<sup>2</sup>

**Abstract:** *The recession tide has underscored the economic regularity of systemic instability of market cycles. Transition economies of Southeast Europe have been overheated for a decade now; they are faced with rising current account deficits, ever larger indebtedness, and unbalanced exchange rates. Macroeconomic effects are clear: in all the countries external debt increased. Systemic imbalances, primarily those of structural nature, have surfaced. The epicenter of deepening structural imbalances in Serbia lies in an ever deeper production gap and the gap of labour productivity.*

*The government is primarily expected to speed up structural reforms as well as to relax structural imbalances. Realization of structural transformations in the first place will depend on industrial policy and the way a more favourable business environment is established. Through special intervention programmes the state is to help creation of a new industrial structure while its state aid mechanisms should stimulate the development of export-driven competitive sectors and sectors that create a high value added.*

**Keywords:** *structural imbalances, transition speed of structural reforms, productivity gap, the rise in indebtedness, post-crisis proactive role of the state.*

## Introduction

*„It is not all about productivity, but in the run it almost is“  
(Krugman, 1990)*

The economic crisis in Serbia is primarily of a structural character – cyclicity is less of a problem. Cyclical tendencies are mirrored in a decline in economic activity and a rise of unemployment resulting from external recession blows during the period 2009-2011. Macroeconomic imbalances have become deeper, and transition economies of SEE have become more vulnerable. The transition model of economic growth, based on the growth of newly created value of non-tradable goods and foreign direct investments, is no longer sustainable, either economically or socially. The increase in budget and foreign trade deficit resulted in a huge increase of external debt of all the SEE economies. The cyclical character of the crisis blurs the scale of structural imbalances in these economies.

Recession blows have accelerated the trend of rising unemployment. In addition to high structural unemployment, by 2008 cyclical unemployment had emerged while entire labour demand was rather low. The Philips curve (Samjuelson&Nordhaus, 2005) for SEE indicates two trends: a) a positive trend in 2000-2008, and b) a negative trend as of 2008, primarily due to the rise of unemployment in SEE. It should be noted that data are averaged at the level of SEE, that they vary from country to country, but that the trend is regular in all the countries.

Structural changes in SEE are unfolding rather slowly and in a selective manner. The recession blow was rather severe for uncompetitive economic sectors of SEE, particularly for the sector of

---

<sup>1</sup> Ministry of Finance, Belgrade

<sup>2</sup> Faculty of Economics, University of Kragujevac, mknezevic@kg.ac.rs

manufacturing industry. Reform processes are about to enter a sensitive stage and encounter new challenges. Integration processes in most SEE countries in the EU are not yet over. Economic disproportions between SEE and the EU are larger by day. The standard of living in SEE in 2011 was 3 times lower (GDP PPS in comparison with the EU average), whereas the unemployment rate was 3 times higher. Economic cohesion in Europe is ever more unsound as the territory of SEE is faced with many forms of poverty (10% of the EU population generates only 1.3% of the EU's GDP).

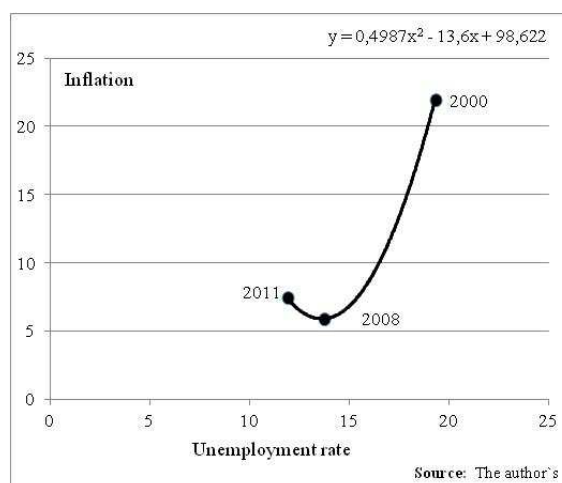

**Figure 1. Philips curve for SEE**

The paper is focused on two objectives: a) to discuss the structural character of macroeconomic imbalances in SEE, placing a special emphasis on the economy of Serbia, and b) to show that sustainability of growth and development is only possible if the state plays an active role in altering the model of economic growth by shifting it towards continual structural changes.

The author's main theses are: a) the speed of coping with post-crisis structural imbalances depends on the state and its efficiency in the first place; b) the epicenter of transition-induced macroeconomic imbalances in Serbia lies in production gap, the gap of labour productivity and structural imbalances, i.e. growth of productivity that is not coupled with the rise in employment does not bring along higher, let alone sustainable economic growth, and c) stabilization measures must be short-term (control and regulation of financial flows, cutting down on irrational public spending, etc.) and long-term (reforms of the public sector, investment climate, and curtailment of education risks). The analytical and methodological instrument set applied in the paper relies on representative composite socio-economic indicators, the analysis of time series, and a comparative and structural macroeconomic analysis.

### **Development gap in SEE**

The economic cohesion in Europe is ever weaker, disproportions are swelling, and the entire area of SEE increasingly trails behind other parts of Europe. The development gap is ever more marked. Five most developed economies in the European Union continually account for more than 70% of GDP formation, and together with medium-sized economies they accounted for 97% of total GDP of the EU in 2010. Owing to faster structural reforms, small economies have managed to increase their share more than two times over the past two decades (from 1.3% to 2.9%) but the area



of SEE has practically lost two decades in terms of development; namely, in 2010 GDP of SEE accounted for a smaller portion of EU's GDP than in 1990. Serbia accounts for 6% of SEE's GDP.

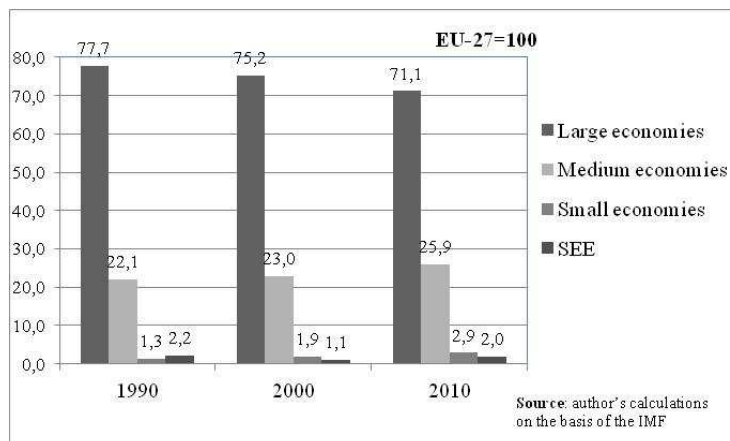

**Figure 2. GDP structure in Europe by groups of countries**

**Note:** Large economies: Germany, France, Great Britain, Italy, and Spain; Medium economies: The Netherlands, Poland, Belgium, Sweden, Austria, Greece, Denmark, Finland, Ireland, Portugal, Czech Republic, and Romania; small economies: Hungary, Slovakia, Slovenia, Luxembourg, Bulgaria, Lithuania, Latvia, Cyprus, Estonia, and Malta; SEE: Bulgaria, Romania, Serbia, Croatia, Bosnia and Herzegovina, Macedonia, Montenegro, Albania, and Moldova.

Generally speaking, the economic transition of most SEE countries has lasted for two decades now. The transformation model of the economic structure in Southeast Europe has not contributed to economic growth – economic systems have not managed to adapt to ever fiercer market game rules and stringent competition demands. Most of the SEE countries saw a belated pre-transition start and slow and random structural reforms that in most economic segments are only in the early stage. The trend of shrinking economic cohesion in Europe is clearly demonstrated by the comparative analysis of economic growth.

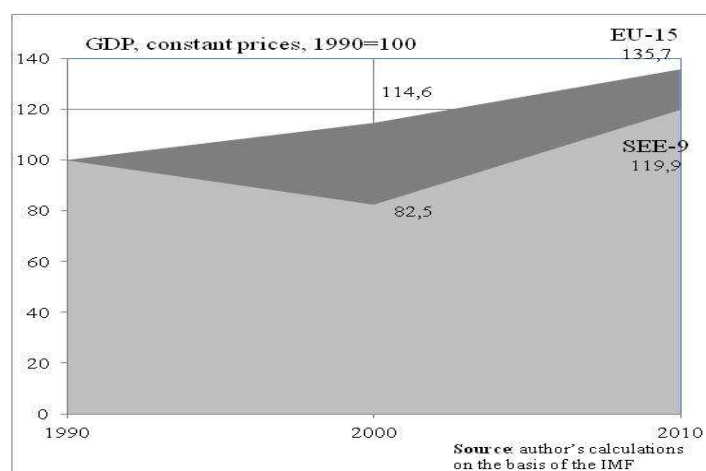

**Figure 3. Trend of declining economic cohesion in Europe**

While differences in GDP between SEE and EU-15 (the group of most developed European countries) in early 1990s stood at 1:50, after two decades of transition the ratio rose to 1:55 (output-GDP in SEE increased by 20%, and in the EU by 36%)

The industrial lag of SEE when compared to other regions of the EU is a primary problem. Due to deficient implementation of transformation models, primarily with respect to the process of privatization of large industrial systems, industrial differences in Europe itself only boomed. The area of SEE increasingly trails in industrial terms not only behind the developed group of states (EU-15) but also ever more behind the group of countries that joined the EU in 2004 (EU-10).

### Transition speed of structural reforms

International barometers of competitiveness present the best indicators of implementation of structural reforms in transition economies. The entire area of SEE is ranked very low, namely at the back of the European competitiveness list.

**Table 1. Comparative competitiveness matrix 2011**

Indicators	ALB	B&H	BUL	CRO	MAK	MOL	MON	ROM	SER
WEF (GCI) – global rank	78	100	74	76	79	94	60	77	95
External solvency:									
o the ratio of external debt and exports	125*	89	170	267	166*	209*	256*	205	210
o the ratio of external debt and GDP	40*	26	102	102%	60*	77*	29*	75	78
Credit ranking (Standard & Poor's, *Moody`s)	B+	B	BBB	BBB-	BB	B3*	BB	BB+	BB
Investment (% GDP) 2010	26	19	24	22	20	23	21	23	18
Inflation 2011 (end period)	1,7	3,1	4,4	1,8	2,8	7,8	2,8	7,9	7
Earnings (net) EUR – 2011	229	417	283	723	338	212	484	338	372

*Source: WDI, WB, EBRD, Eurostat, national banks and statistics*

In the latest *Competitiveness Report 2011-2012 (of the WEF)* Serbia is ranked 95<sup>th</sup> and is at the foot of the group of 28 countries (Stage 2) that through improvement of efficiency aim for achieving economic growth and improving the competitiveness position overall.

A comparative review of the competitive position of Serbian economy and adjacent transition economies demonstrates, firstly, various degrees and speed of implementation of transition reforms.

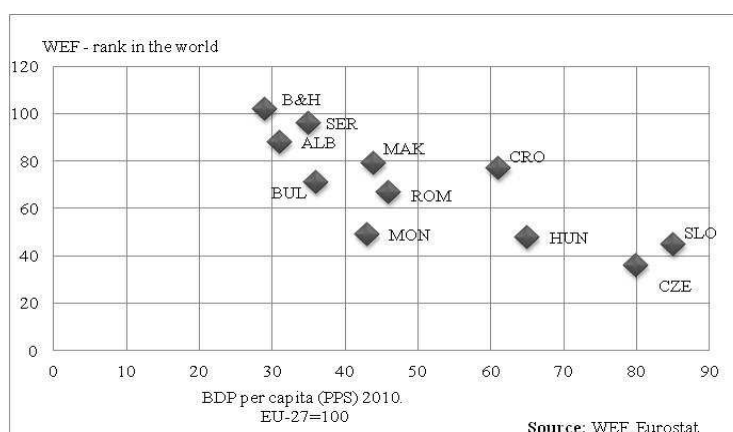

Figure 4. Competitive position of SEE 2011

Post-crisis macroeconomic imbalances in Serbia

Productivity gap

Recession trends in the area of SEE manifest themselves as a combination of high unemployment and high external trade deficit, which directly leads to the problem of productivity and competitiveness of SEE economies.

Table 2. Labor productivity as % of US, 2011

	GDP per person employed	Labor productivity per hour	Effect of working hours
EU-15	75.9	81.7	-5.8
EU-10	40.3	36	4.3
SEE-9	25.3	20	5.3
Serbia	21.6	18	3.6

Source: The Conference Board Total Economy Database 2012

Labour productivity gap in the EU compared to the USA is ever more marked. Productivity of the group of most developed countries, EU-15 lags behind that of the U.S. by 25%, of EU-10 by 60%, while the area of SEE lags behind by as much as 75%. Labour productivity measured by the hour of work is even more unfavourable for transition countries. An employee in the U.S. is five times more productive, and in EU-15 4 times more productive than an average employee in SEE. Labour productivity in Serbia is lower than average in SEE.

After the changes that took place in 2000, Serbia entered the period of intensive political, economic, and social reforms. Although Serbia managed to catch up with other countries over the previous decade (the transition process in Serbia started later than in other post-socialist states), significant structural reforms are yet to be undertaken, while priorities are to complete privatization of enterprises and improve conditions for doing business.

Economic growth, as expressed through the increase in GDP per capita and being a prerequisite for economic development, does not necessarily lead to development. By decomposing the indicator of GDP per capita, one will see that high productivity that is not paired with high employment does not produce high, let alone sustainable economic growth.

$$\frac{\text{GDP}}{\text{Population}} = \frac{\text{GDP}}{\text{Employees}} * \frac{\text{Employees}}{\text{Population}}$$

**Productivity      Overall employment**

Although employees in Serbia are more productive than Romanian employees, higher employment relative to overall population of Romania caused higher values of the indicator of GDP per capita. On the other hand, high-level overall employment in Bulgaria is not socially viable as labour productivity of employees is rather low and in the following period one can expect to see a drop in employment. Economic growth of Slovenia is sustainable in the long run: a high percentage of overall employment is coupled with high productivity of employed workers.

**Table 3. Decomposing GDP PPP/pc in 2010 (\$)**

	GDP PPP per capita	GDP PPP per employee	Overall employment, in %
EU-27	31,676	52,481	60.36
Bulgaria	13,780	34,049	40.47
Croatia	19,516	56,023	34.84
Hungary	20,307	53,753	37.78
Romania	14,287	33,157	43.09
Slovenia	27,556	58,559	47.06
Serbia	11,488	34,961	32.86

*Source: World Bank, MF, Eurostat; Note: Employment by the Labour Force Survey*

### ***Production gap***

The transition model of economic growth in Serbia was based on the increase in domestic demand and investment capital from abroad. Continually the expenditure side was larger than the income side, a characteristic of insufficient output and ever more pronounced production gap. After a decade of devastation and economic distortion, a non-restructured economic system was not able to create competitive production. The economy is in an ever greater financial misbalance: in 2002 the loss equaled 9.7% of GDP and in 2010 it rose to 13.8% of GDP, accumulated loss increased in real terms by 50%, indebtedness increased 2.3 times, while the rate of lost capital is higher than the one registered at the start of transition.

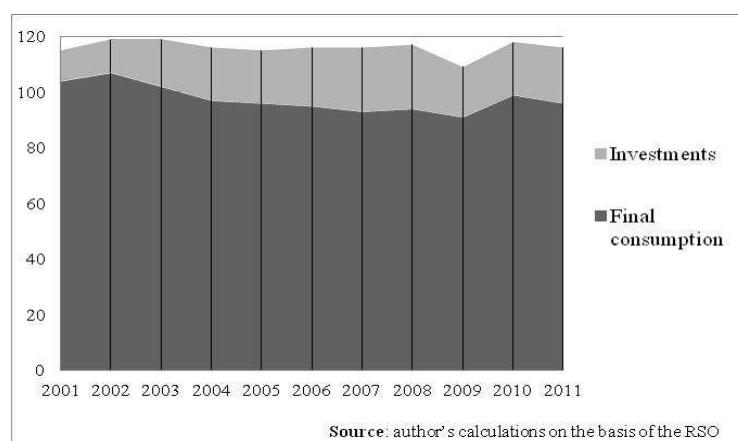

**Figure 5. Transition surplus of domestic demand compared to output (% GDP)**

Manufacturing industry, a driver of development, is living its hardest days in the last two decades. Despite the fact that in the transition period gross value added in manufacturing industry doubled, manufacturing industry of Serbia produces 50% less than manufacturing industry of Slovenia, almost 3 times less than Slovakia, 4 times less than Hungary, and as much as 6 times less than Czech Republic. Industrial decline in 2009 (-12.1%) caused by the global recession annulled the entire transition contribution of manufacturing industry to economic growth – its share of 14% in GDP is the lowest in the region.

#### *The rise in indebtedness*

The debt problem has been in the focus of transition countries for almost two decades. The problem had been becoming more serious by day and eventually, as the global recession was gaining speed, it spilt over to SEE countries on a major scale; today it is one of the most pressing problems that will completely inhibit development unless properly addressed. The level of total external debt by the end of 2011 for most SEE countries was above the red line.

**Table 4. The level of external debt in relation to GDP (in %)**

	2008	2011
Slovenia	100	118
Croatia	85	103
Hungary	111	145
Romania	52	55
Serbia	65	79
Macedonia	49	67
Bulgaria	108	92

Source: Eurostat

Major ‘triggers’ of the indebtedness increase are two key macroeconomic deficits: a) deficit of the current account of the balance of payments, and b) budget deficit.

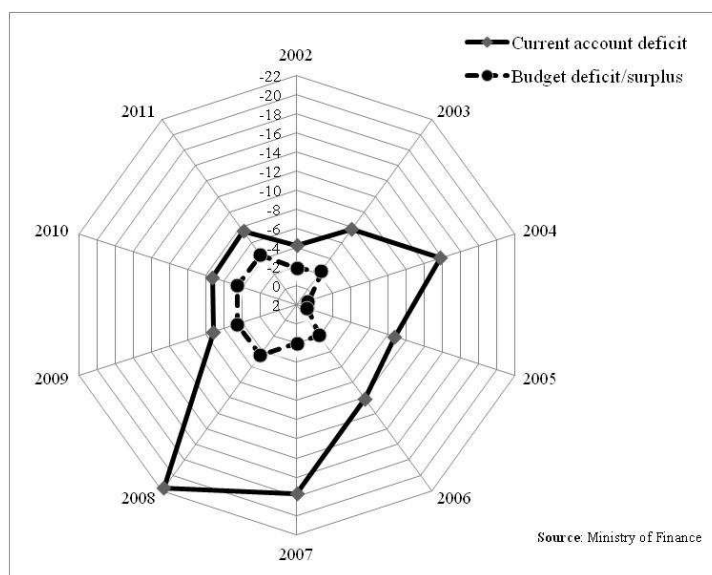

**Figure 6. Transition radar of key macroeconomic deficits**

Throughout the entire transition period since 2001 Serbian economy has been faced with external misbalance caused by rising external trade deficit which is financed through loans coming from abroad. The inflow of FDI also partially funds the rising deficit of the current balance. Due to recession blows in 2009 deficit of the state sector deepened as a result of a decline in economic activity (a decrease in tax revenues), which was somewhat smoothed in the second half of 2010 (4.4%). The current public consumption was lower, which enabled creation of room for fiscal incentives, i.e. subsidies and ‘soft’ budget loans to economy and households.

Apart from risks such as the level of total debt and its defrayment, a special problem is efficiency of borrowed resources. The central problem of indebtedness not only in Serbia but also in the entire SEE is the usage of borrowed funds for consumption (personal and government) and not for production.

### Structural imbalances

Structural effects of the transformation model in the area of SEE are almost identical in all the countries: a) a drop of industrial employment, b) services dominate the structure of newly created value (GVA) with 2/3, c) the technological structure of newly created value is by more than 50% accounted for by low-tech sections.

The growth trend of non-tradable sections is present in the entire area of SEE. The share of the sector of agriculture in GVA was halved in Serbia, Bulgaria, and Romania, but it is still high in least developed countries (Albania and Macedonia). The sector of industry registered a continuous decrease, while the highest rise in services was registered in Serbia, Macedonia, Montenegro, and Romania.

Over the past decade the structure of GVA of Serbian economy has intensively been changing in the direction of the service sector, which in 2010 accounted for 63.8% of the value of GVA (by 11.2 structural points more than in 2001). The sector contribution of the primary sector was halved – the share of agriculture in GVA dropped from 19.5% in 2001 to 10.1% in 2010. In 2001-2010 the sector

of industry and construction saw an average annual growth rate of only 0.5%, in agriculture of 1.9%, and in the service sector of 4.4%.

**Table 5. Transition sector changes to the structure of GVA in SEE**

SEE	Agriculture		Industry		Construction		Services	
	2001	2010	2001	2010	2001	2010	2001	2010
Serbia	19.5	10.1	24.6	21.7	3.3	4.4	52.6	63.8
Croatia	6.5	5.5	22.8	19.0	5.6	6.7	65.2	68.8
Macedonia	11.8	11.2*	26.1	21.5*	6.0	5.9*	56.1	61.4*
B&H	10.8	8.3	19.8	20.8	6.2	5.1	63.2	65.8
Montenegro	11.9	9.2	20.8	13.5	3.9	6.1	63.5	71.2
Albania	23.6	18.8*	7.3	10.0*	10.4	14.2*	58.7	57.1*
Bulgaria	13.1	5.3	22.2	23.1	4.8	8.1	59.9	63.5
Romania	14.7	6	29.4	28.7	5.9	9.6	50	55.7

*Source: Eurostat and national statistical offices; Note: \*data refer to 2009*

The technological risk SEE faces is ever more prominent. Structural changes have not been conducive to the transformation favouring sectors that create higher value added and are focused on knowledge-based activities. In Serbian economy the number of enterprises, employment, and the newly generated value in low-tech and medium-low-tech industries increased (LT and MLT) while at the same time the share of medium-high-tech and high-tech industries decreased.

**Table 6. Negative technological trend of the structure of industrial GVA – changes 2010/2004**

Technological sections	No of enterprises	Employment	GVA
Low-tech (LT)	7.0	1.5	2.1
Medium-low tech (MLT)	4.7	2.7	5.3
Medium-high tech (MHT)	-4.2	-2.0	-7.8
High-tech (HT)	-7.5	-2.2	0.3

*Source: author's calculations on the basis of the BRA*

### Post-crisis proactive role of the state

In the post-crisis period a state impacts on the speed of the economy's going out of recession by means of its instruments (Polanyi, 2003). The efficiency of the budget policy depends on the degree of compatibility of the fiscal policy and the industrial policy pursued by the state, all of which influence structural changes in economy and the boosting of its competitiveness. The post-crisis state interventionism comprises measures of a temporary and a permanent character. According to the public choice theory, a proactive role of the state is focused on establishing a stimulating climate for investment. The primary post-crisis goal is macroeconomic stability and budget balancing. In the medium term macroeconomic balances will hinge on the degree of realization of the industrial policy.

In the long run state interventions in education, research, and development yield the highest rate of return and contribute to economic growth and development most.

**Macroeconomic balance**

One of the key problems transition countries in the post-crisis period face is budget misbalance, i.e. the level of budget deficit. Consequences of the budget deficit are long-term: (a) when a state borrows, future generations carry the burden of lower spending; (b) because of increased indebtedness, the standard of living of future generations can be undermined, and (c) lower public saving cannot be compensated by private savings.

Through its budget policy the state sets national priorities, distributes total output to private and public consumption and investments (Grinols, 1996), and creates a stimulating policy for priority sectors. Through its fiscal and monetary policy the government strives to affect business changes and key macroeconomic variables (Hjum, 2008). When it comes to public finance, it is essential one distinguishes between a structural and a cyclical deficit. As a rule, structural deficits are an active part of the budget and they can be affected through fiscal policy and allocations for defense, education, etc. As different from this, a cyclical segment of the budget cannot be affected and its level hinges on output, income, recession, etc. In the wake of recession, budget deficit in Serbia is ever higher and its cyclical component is ever more pronounced.

The analysis into the structure of the budget deficit provides important information to creators of the economic policy as it shows the difference between a long-term trend and cyclicity factors (Brummerhoff, 2009). The structure of public expenditure partially has a discretionary character and, on the other side, cyclical deficits indicate automatic signals of the state in economy.

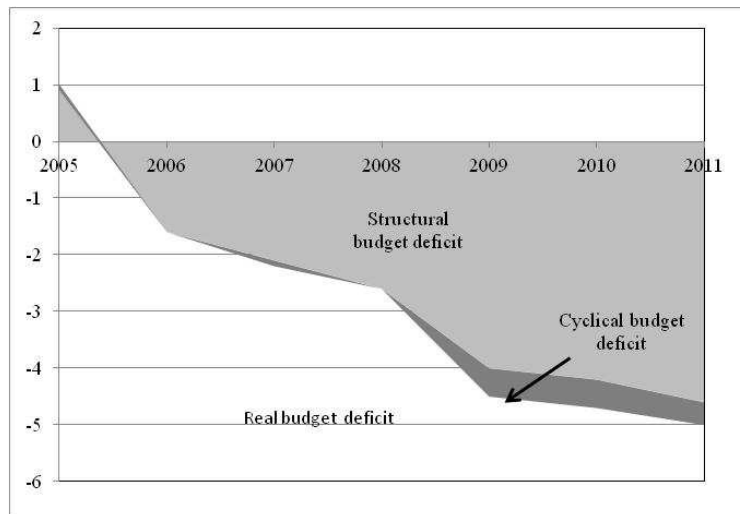

**Figure 7. Structure of budget deficit (% GDP)**

**Note:** The real budget deficit comprises the actual deficit; the structural budget deficit includes the calculation as to how high a deficit would be if GDP has a potential value (if economy generates potential output); the cyclical budget deficit is a difference between the real and the structural deficit.

Weaknesses of application of fiscal policy instruments in addressing the problems of cyclicity, i.e. aggregate demand are ever more pronounced. Hereby we refer to the factor of effect delay as it is difficult to identify the point of a cyclical shock or the point of the cycle turnover. In addition, it has



been proved that is easier to lower taxes than to raise them, and that it is easier to raise consumption than to cut it down (Samuelson & Nordhaus, 2009, p.719-719). Even the well-known attitudes on efficiency of the fiscal policy (namely, in times of recession taxes should be temporarily lowered) do not necessarily produce anticipated results. At a macro level, the structural budget deficit is important for solving the problem of macroeconomic balance as by raising budget savings there would be more room for investment.

Given that it is extremely difficult to forecast economic cycles and, accordingly, make right and timely decisions, economic scholars make a strong case for introducing rules and reducing discretionary decisions. This particularly refers to instable economies that are permanently faced with the problem of macroeconomic imbalances.

### *Industrial policy*

The government has introduced a new concept of industrial policy of Serbia by 2020 that is based on the process of consistent implementation and adjustment of structural reforms and establishment of an environment in which all the participants in these processes (private companies, trade unions, and the public sector) cooperate and make partnerships, which will enable them to solve their problems and respond to future challenges. Basically, the industrial policy has a proactive character, it is oriented towards export competitiveness of industrial products and services with a high value added that are based on knowledge, innovations, research, and development. Therefore the most fundamental question is: why some countries are more successful in reaching this objective than others and why, despite rather similar conditions when it comes to macroeconomic stability, market openness, regulatory framework, etc. they make excellent results when shifting their production towards products with a higher value added, while others trail behind and are less developed than their competitors. Although traditionally the initial assumption is that the success of the first ones depends exclusively on the power and capacities of companies themselves and market conditions (Fukujama, 2007), over the past 20 years an understanding has prevailed according to which a larger portion of accountability when it comes to issues of rapid technological growth, particularly in underdeveloped or transition countries but also in developed countries, rests with the state and its institutions (Chang, 1993), knowledge they possess and capacities to find optimal solutions.

### *Investments in human capital*

Competitiveness of an economy primarily depends on educated people who learn fast, who are innovative and creative, and manage to adapt their own abilities to technological development and global development trends. In order to respond to these requests, it takes sweeping reforms in education whose standards lag behind European ones and do not satisfy needs of the present economic structure. Without reforms of the education systems it is impossible to implement structural reforms in economy (Arrow, 1973).

Not only in Serbia but rather on the territory of entire SEE the education policy is not clearly focused on creation of human resources and does not reflect objectives of the Lisbon strategy set in education and training, such as: higher quality and effectiveness, the access to education guaranteed to everyone, and openness for a wider world. Moreover, education is not financially adequately supported.

Estimated expenditure on education in most countries of SEE, according to the EU methodology (ranging in the interval of 4-5% of GDP) are lower than the average of allocations at the level of EU-27 (5.3% of GDP) but much lower than the OECD recommendation (6-8% of GDP).

**Table 7. The educational differences**

	Expected years of schooling	Mean years of schooling
Serbia	13.7	10.2
Slovenia	16.9	11.6
Hungary	15.3	11.1
Czech Republic	15.6	12.3
Denmark	16.9	11.4
SEE	13.3	9.8
EU-10	15.4	11.1
EU-15	16.2	10.6

*Source: author's calculations on the basis of the UNDP*

The entire area of SEE is faced with increasing education differences. Although the Human Development Index shows that SEE countries are in the group of states with high HDI, the analysis of the HDI structure demonstrates various differences within the area itself and the scale of the education gap in some components, primarily the analysis of values of one of the key education indicators – expected years of schooling (the population aged above 25). This representative indicator of education development shows that Serbia trails by more than 2 years behind some of the adjacent countries.

The OECD analysis of investment risk in SEE countries shows that improvement of these two components will determine the development of human capital. Given that reduction of structural imbalances will depend on state interventions and investments in human capital, major problems the new model of economic growth is faced with are:

- a lack of liaison between the industrial sector and research institutions
- the share of the private sector in R&D is marginal
- allocations for education and science are at a very low level
- science and research capacities are weak
- allocations for adult education are low
- the system work related to continual education is undeveloped, and
- there are no efficient regional models of strengthening the quality of training.

## **Conclusion**

Despite being aware of the fact that the state will react in case of the crisis, economic subjects are again and again finding new ways to borrow and place funds through financial innovations and thus evade regulations and limits on a wide scale. On the other hand, in order to avoid negative effects of unregulated financial innovations as much as possible, regulatory organs must continually monitor the development of financial markets and amend legal regulations. Back in 1986, in the period of deregulation euphoria, such a warning to regulators was issued by Minsky:

‘If they want to curb disturbances produced by the banking sector, authorities must give up on their carousal and accept the need to manage and control the evolution of financial uses and practices.

In the world of business people and financial mediators that are seeking for profit aggressively, innovators will always be ahead of regulators; regulators cannot prevent changes to the portfolio structure. What they can do is to maintain the relation between assets and ownership capital within prescribed limits by establishing adequate relations between ownership capital and various forms of assets. If authorities manage to harness banks and are aware of activities of banks and other financial institutions on the basis of which the latter aim to avoid regulation, authorities will be in a better position to moderate damaging expansion tendencies within our economy' (Minsky, 1986).

The main message conveyed by the paper is the following: in order to be able to establish macroeconomic stability and better manage risks in the post-crisis period, it is necessary to control the key factor of the crisis – reduction of macroeconomic imbalances. To achieve macroeconomic stability in the post-crisis period means to provide an answer to the question as to how to restore an unbalanced economic system to a new balance point. The epicenter of the problem is a rising trend of the budget deficit as budget revenues are ever more used to repay public debt and for consumption, which discourages investment and economic growth. In parallel with this, the rise of public consumption and public debt directly boosts aggregate demand and creates inflation pressure. A balanced budget is a primary short-term measure; it is necessary to address the problem of the structural budget deficit, introduce stringent budget rules, and reduce discretionary decisions.

In the medium run structural imbalances will depend on whether the production gap will be diminished and labour productivity boosted – in a word, on the degree of realization of industrial policy and government's capacities to realize the adopted proactive role. In the long run, most significant are government interventions and investment in human capital in the area of education, research, and development. It is essential for reforms of the education system to be in keeping with economic needs, to establish an active institutional system in which science and industry are linked, and to steer the incentive policy towards innovations in the entrepreneurial sector.

## References

- Arrow, K.J. (1973). Higher Education as a Filter. *Journal of Public Economics* 2. 193-216
- Brummerhoff, D. (2009). Javne finansije. Zagreb. *Gospodarska misao*. 414-418
- Chang, H. (1993). The political economy of industrial policy in Korea. *Cambridge Journal of Economics* 17: 131-157.
- EBRD. (2011). *Transition Report 2011*.
- Fukujama, F. (2007). Građenje države. Beograd. Filip Višnjić. 13-32.
- Grinols, E.L. (1996). The Link Between Domestic Investment and Domestic Savings in Open Economies: Evidence from Balanced Stochastic Growth. *Review on International Economics* 4. 119-140.
- Hjum, D. (2008). *Politički eseji*. Beograd. Službeni Glasnik. 240-244.
- International Monetary Fund. (2011). *The World Economic Outlook: Slowing growth, rising risks*. Washington DC.
- Jakopin, E. and J. Bajec. (2009). Challenges of Industrial Development of Serbia. *Panoeconomicus*, 56 (4). 507-523.
- Jakopin, E. and J. Bajec. (2012). Structural transformations-a development imperative. *Ekonomika preduzeća*, 65 (1-2). 63-78.
- Lin, Y. J. (2010). *New Structural Economics - A Framework for Rethinking Development*. The World Bank. WPS5197.
- OECD. (2001). *Structural change and growth: Trends and policy implications*. Directorate for Science, Technology and Industry. Paris.
- OECD (2010): *Investment Reform Index: Monitorinig Policies and Institutions for Direct Investment*.

- Polanyi, K. (2003). *The Great Transformation*. Beograd. Filip Višnjic. 197-214.
- Porter, M. (2008). The Five Competitive Forces That Shape Strategy, *Harvard Business Review*: 25-39.
- Републички завод за развој. (2011). *Стратегија и политика развоја индустрије 2011-2020*. Сл. гласник. Београд.
- .Samuelson, P. and V. Nordhaus. (2005). *Economics*. McGraw-Hill Companies, Inc. 679-688.
- The Conference Board. (2012). *Performance 2011: Productivity, Employment, and Growth in the World's Economies*. (1-15 jun 2012). <http://www.conference-board.org/data/economydatabase/>
- UNDP. (2011). *Human Development Report 2011*,
- USAID. (2010). *Postkrizni model ekonomskog rasta i razvoja Srbije*. Beograd.
- .World Economic Forum. (2011). *The Global Competitiveness Report 2011/2012*. New York. Oxford University Press.

# THE INTERACTION OF THE PROCESS OF TAXATION AND THE INTERNATIONAL TRANSACTIONS

Srdan Đinđić<sup>1</sup>

**Abstract:** *In the format of the world economy, the paper emphasizes the interdependence between the process of taxation and the investments of MNCs. The tax payers that reside and pay their taxes in one country, can receive the income originated and taxed in another country. The problems of overlapping of national tax jurisdictions must be solved by one of the available methods for sharing the international tax bases. The deduction method has a role of the following or a correctional method. The method of credit, though it was a dominating form until recently, practically disavows the possibility of manipulation with a postponment of tax paying. In the paper, the exemption method is favoured, because it's complement to the actual transcontinental parametres of the tax and economic relationships, because of which it became a norm among the OECD countries.*

**Keywords:** *multinational corporation, process of taxation, economic transaction, world tax system, world tax base, method of taxation.*

## Introduction

A multinational company is „a halfway house“ between countries of residence and of source, which are, because of their own national interests, mutually interested in sharing the international tax prey, a taxable income. A transfer of an economic activity abroad can have a far-reaching influence on national interests of a country. Export (import) of capital is one of the crucial determiners of the level and distribution of national and worldwide income, because of which the tax policies that profile export-import flows of capital are a very important instrument of the economic policy. A country of residence can design the tax policy solely for the purpose of maximising the national income, neglecting other prestigious goals such as maximising of the worldwide income or the issues of an international redistribution that request investments into less developed countries. A source country observes the globalisation of the economic activity from the perspective of its own economic interests, including an increase of the national income and its distribution, consolidated balance of payment and an improvement of the terms of trade. Finally, it can think of the tax income as of a national return from the production factors rented to foreign investors, regardless to whether they're natural resources, educated or cheap labour or an open market.

The fundament underlying this paper consists of the answers to two questions: Commented from the point of view of the residence country, why do multinational corporations invest abroad? The return rates differ among foreign countries, whereas the multinational corporations have universally been motivated by maximising of the after tax return rate that can be achieved on foreign investments. What are the original advantages of the multinational corporations (MNCs)? The specific advantage of a MNC is located in the sphere of productivity. Variability of productivity is systematically connected with the degree of the exposure of the corporation to the international competition (Desai, 2009; Yeaple, 2008): (1) exporting firms are by 14% more productive than the importing ones; (2) multinational firms are more productive than nonmultinational exporters by similar margin; (3) the differences in productivity are also present within the multinational corporations, the productivity

---

<sup>1</sup> Faculty of Economics, University of Kragujevac, [srdjanmdjindjic@gmail.com](mailto:srdjanmdjindjic@gmail.com)

## THE INTERACTION OF THE PROCESS OF TAXATION AND THE INTERNATIONAL TRANSACTIONS

---

varies systematically about how large a firm's foreign operations are. This analytical matrix implies the hypothesis of the paper that reads: if the competition of the domestic economic actors is the primary goal of the tax (economic) policy of a country, then an exemption of their income acquired abroad from the domestic process of taxation is the best methodological answer.

Having in mind the stated work hypothesis, the structure of the work will be operationalised by the means of two tasks. First, we will present the essential features of the interactive relation of the taxation and international transactions, including an analysis of the effects of overlapping of the two national tax jurisdictions in the absence of any mutually coordinated measures. Then, we will focus on the analysis of the performance of the functioning methods of the international taxation. We will emphasize the attitudes regarding the key question: In the context of the typical goals of the tax policy, what variorisational facts should be pointed out related to a relative change of the double tax?.

### The main features of the taxation and international transactions

An economic activity often crosses the national borders, the significance of the international trade increases, as well as the flows of national capital, labour and income. A significant part of the investments of domestic multinational corporations (MNCs) goes abroad, so conditioning an overlapping of the national tax jurisdictions and opening the multidimensional question of international double taxation. The problems of the overlapped international taxation must be solved, because they lead to unefficient and unfair results. What national tax jurisdictions should be eligible to tax what part of the tax base and at what rate? Should these problems be absolved by a unilateral approach which, independent on the environment, is exclusively oriented towards the growth of the national income, or should they be solved by the cooperative approach that respects the implications of the taxation on the condition of the international economy and the worldwide income? Before we approach to the consideration of the characteristic questions, we will post the problem of the international taxation. Since the aim of the international policy is connected with the income a subsidiary makes abroad, the answer will be completed and illustrated by a practical example, as the true picture of the international practical tax reactions. We are observing one foreign subsidiary that does its business activity abroad, in a source country, separately from the parent corporation (from a residence country) that owns it. The income tax rates in the residence and source countries are 30% and 20%, respectively. The foreign subsidiary realises the taxable income in the country of source of 1,000,000 monetary units. Based on these starting assumptions, we, at start, present the effect of the overlapping of two national tax jurisdictions in the absence of any coordinated measures between them, in other words, we count the total sum of the tax burden of 50% and the sum of the double tax of 500,000 m.u., in the absence of a method of avoiding the international double taxation (Table 1).

**Table 1. The effect of the double taxation of a multinational cooperation  
(in monetary units, unless noted otherwise)**

1. The foreign tax in the country of the source of income = $1,000,000 \times 20\% = 200,000$
2. The tax in the residence country = $1,000,000 \times 30\% = 300,000$
3. The global income tax = 500,000
4. The global tax rate = 50%

*Source: counted by the author*

The process of international taxation lies down on two rights to tax the income. One right to tax belongs to the country of residence of the income recipient (the residence country of the tax payer

realises the corporation taxation on the basis of its worldwide income, i.e., the income earned in the country, but also the income earned abroad – in the source countries). One right to taxation belongs to the country of the source of the income, completely independent on any other criterium, the principle of residence, for example ( based on the concept of territory, the principle of the source practically means that the autonomous right to taxation belongs to the country where the profit is formed). In the international set of processes of taxation, each country can find itself within two opponent tax-investment roles, in the position of a domestic economy of the capital exporter (the residence country in which the parent corporation was registered) and a foreign economy of the capital importer (the source country where the business is done by the subsidiaries, which are owned by the parent corporation from the domestic residence country). How is the allocation of the international tax base between the country the tax payers has the nexus with practically realised? The developed countries, and not only them, first want to approach to the international tax issues unilaterally. However, the allocation is standardly realised by a bilateral approach, by signing bilateral agreements which are, essentially, pragmatic rules of management of the purpose, that is, of a feasible way of cooperative arrangements (a division of the international income) between two political jurisdictions, and which are operationalised by means of three methods of avoiding/mitigating the international double taxation. The first, the method of a tax deduction ( the tax paid in the source country is deducted, as a business expense, from the tax base in the residence country). The second, the method of a credit for foreign taxes- „tax credit“ (the tax paid in the source country can be deducted from the tax predicted in the domestic residence country; two alternative forms figure, „ordinary credit“ and „full credit“, where the former is important from the practical point of view, whereas the latter is crucial from the point of view of defining the exact theoretical standards for the taxation; with the „full credit“ the residence country allows a deduction of the total, unlimited tax counted/paid on foreign income; with the „ordinary credit“ the residence country allows a deduction of the tax that would be counted/paid on the identical domestic income, therefore, the income earned in the very residence country. The third, method of exempting of the foreign income from the domestic taxation – „tax exemption“ (the income taxed in the source country is not taxed in the residence country; two alternative forms figure, „full exemption“ is preferable, because the residence country exempts the foreign income in total from the domestic process of taxation, whereas the „exemption with progression“ allows an exemption in the height of the average tax rate predicted on the income in the country of residence, OECD, 1995, 2010; Brys, Matthews and Owens, 2011).

### **Valorization and the effects of the international double taxation**

The international taxation rests on two rights to taxation of the international tax base, whereas the nucleus of the problem is a rationalisation of the taxation procedure, whose epicentre oscillates around the balance of the „paid taxes“ that the foreign subsidiaries paid to the foreign governments in the source countries, and the „approved preferences“ (a deduction, a credit or an exemption) in the domestic residence country of the MNC. The rationalisation marks the focus intention of each country to, by a choice of a specific method, realise the defined goal of its tax policy. What is „the right“ method? In order to understand and compare the effects of certain methods in the sphere of management of the international capital flows, first we must clearly determine the goal of the tax policy. The first goal of the tax policy could be maximising the national income. The second could be maximising the worldwide income.

In the circumstances of non-existence of a global capital market, because of which in the given residence country the supply of the capital is limited, we can strongly support the attitude that the tax policy should be put in the function of maximising the national income, not maximising the income at the level of the worldwide economy.

## THE INTERACTION OF THE PROCESS OF TAXATION AND THE INTERNATIONAL TRANSACTIONS

---

We base the analysis of the international taxation on the orthodox economic assumption that a typical multinational corporation, when deciding which country it will invest in and how much money, is led by the height of the after return rate from the domestic and foreign investments: since it's primarily motivated by maximising its own income, the MNC invests to the point where the after tax return rates equalize on both sides, both in the domestic residence country and in the foreign source country. In other words, during formation of the investment structure that maximises its own business income, the MNC takes into account the fulfillment of the following condition of efficiency: the after tax return on the domestic investments in the residence country = the after tax return of the taxation of the foreign investments in the source country. Is the structure of the investments, that is optimal for the MNC (and maximises its income) at the same time optimal also from the point of view of maximising the national income of the residence country? Is the fulfillment of the condition in the national interest? Observed from the point of view of the national economy, the fulfillment of the presented condition is not in the national interest, because the taxes paid to the domestic government (in the residence country) are not an expense but an income, whereas the categorization of the taxes paid to the foreign government in the source country is of a different character – they represent the expense category, that is, they don't constitute the national income (the size of „the national income“ comprises the sum of the „before tax income“ made in the country and „the after tax income“ made abroad, because the taxes that MNCs pay in their own countries of residence are part of the national income, no matter that the funds are not available for the MNCs themselves: therefore, the income realised in the residence country is counted before the taxation; the taxes paid abroad, in the source country, are not available to the domestic government, because of which the after tax return the subsidiaries made abroad constitutes the national income of the residence country, Richman – Musgrave, 1963; Musgrave, 1969; Musgrave, 1972 (1959); Musgrave & Musgrave, 1989).

### *The method of deduction of the foreign taxes*

Which method of the international taxation is adequate, if the aim of the tax policy is maximising the national income based on the principles of national neutrality? The country of residence should „normally“ tax the foreign corporations that operate on its territory, whereas it will allow the deduction of the foreign taxes its subsidiaries paid in the source country. From the position of the residence country, the tax paid to the foreign governments is the expense of taking the business abroad, and because of that it should be treated as all the other expenses.

The method of deduction is practically manifested: (1) Through the increase of the global tax rate (44%, Table 1) and the global tax (440,000 m.u.), related to the corresponding sizes of the rates and taxes in the remaining methods. (2) Through a consequent sanctioning of the foreign investment, because of the presence of the international double taxation, whose size is in the function of the realisation of the rates in the countries of residence and source. (3) From the moment of its establishing up to nowadays, the method of deduction passed „the road“ from maximal glorification to practical denial. According to the axioms of the classical thought of public finances, the method of deduction was once promoted as the globally „respectable methodology“ (for an export-oriented country, for an economy a net importer of the capital, a deduction of the foreign tax provides the promotion of the national neutrality and maximising of the domestic national income, Richman-Musgrave, 1963.). Nowadays, because it initiates the double taxation and, in accordance with this, it represents a barrier to the growth of transnational transactions, the method is not applied in practice, with the exemption of the ad hoc role it has in the form of the following or a correctional method.

### *The method of credit for the foreign taxes*

In the circumstances of non-existence of a global capital market, because of what in the given residence country the supply of capital is limited, the suspicion can be opened that the method of deduction and the principle of neutrality maximise the national interests. What is the tax-economic



scenario in the case of activating the latter goal of the tax policy, the maximising of the worldwide income? The typical multinational corporation, therefore, primarily thinks of the maximising the business income (based on the previous comment, the corresponding condition of the efficiency is: the after tax return on the domestic investments in the residence country = the after tax return on the foreign investments in the source country).

What method of the international taxation is complement to the maximising of the worldwide income? By making the investment decisions on the basis of the presented condition, the MNCs allocate the capital abroad, in certain source countries, so that the after tax return in all the countries is the same, which satisfies the concept of the capital export neutrality. This concept implies a similar tax treatment of the domestic and the foreign investments, regardless to where the income was earned (when the creators of the tax policy advocate an efficient allocation of the capital worldwide, then the capital should be taxed at the identical rate). The original implementation of the concept of capital export neutrality means that the residence country must apply the principle of worldwide taxation and, possibly, completely eliminates the double taxation through granting of the full tax credit, in order to ensure the assessment of the tax at the domestic tax rates, regardless to the place of investing (Monsenego, 2011). However, the theoretical ideal of the tax credit method hasn't been achieved, because in the sphere of the practical implementation two deviations were shown: (1) the exclusive application of the ordinary credit and (2) a manipulation with the delay of the tax payment.

(1) In practice, there isn't the method of full crediting of the foreign taxes at present. The residence country allows to its parent corporation for the ordinary credit on the income realised abroad (in the source country), only up to the amount of the tax that would be, on the same basis, paid in the residence country itself (if the full crediting of the foreign taxes were applied, then the residence country would give the „keys“ of its treasury to the source country; let's imagine the following example, the source country could increase its income tax rates, however, the foreign subsidiaries would be entirely uninterested in these worrying tendencies, since the increased tax could be credited in the full amount by the tax liability in the domestic residence country; the method of the full credit could be practically manifested in the form of a money transfer from the residence country into the source country, while the credit limit is an instrument of prevention of the possible transfers).

The practical example illustrates the international tax relations (Table 1). The method of a foreign tax credit, as until recently the prevailing methodological form in the world, pays attention to stimulation of the international corporate pursuits. Because the residence country cedes its tax jurisdiction, in so far as the resource country applies its one, the result of manifestation of the credit method is a reduction of the global tax and a global tax rate of a multinational corporation (according to the method of credit, the residence country has the subsidiary tax right, which is activated in case that the foreign subsidiary in the source country was taxed at a lower rate than the rate in the residence country – then the MNC must pay an additional tax in the residence country on its worldwide income – exactly as we assumed in our example; by contrast, when the foreign subsidiary in the source country was taxed at a higher rate, it means existence of a credit limit, which is conceptually less representative and shows in practice more rarely). If the method of crediting of foreign tax payments is active, and not the method of deduction, in the residence country the tax is reduced to 100,000 m.u as well as the tax rate to 10%, but also the worldwide tax is reduced to 300,000 m.u. The residence country ceded its tax jurisdiction, in other words it reduced its own tax rate (30%) by the height of the foreign tax rate of the source country (20%), so that the MNC paid only 10% of the corporate income tax in the domestic residence country. Therefore, the method of credit for the foreign tax, that is, the method of equal treatment of the domestic and foreign incomes of the corporate sector, „connects“ the testimony of its own deep justification to the neutrality in the area of the export flows of capital.

(2) The authentic functional characteristic of the method of credit is presence of the time lag possibility with the respect to the moment of paying the tax in the residence country. MNCs are

## THE INTERACTION OF THE PROCESS OF TAXATION AND THE INTERNATIONAL TRANSACTIONS

---

interested in broadening their business activity beyond the country borders, because the international income is taxed after the repatriation from the foreign subsidiary from the source country in the parent corporation in the residence country. Because the procedure of the international taxation predicts the time lag, because the parent corporation can decide on its own if it will pay the tax in the near of the further future, the decision about the moment when the repatriation of the foreign income will be done undoubtedly reduces the effective tax rate: if the source country has the income tax rate of 10%, such as in Serbia, for instance, whereas the comparable rate in a residence country is 25%, such as the convergent rate in the OECD-34 (OECD, 2012), the parent corporation can postpone the taxation in the residence country to the amount of 15% of income, so that the present value of the tax payments is lower than if the taxes had been paid at the moment when the income was earned. This methodological solution hides a manipulative potential in the form of global dispatching of the tax burden, by what it falls into its own trap of the normative protocol. By an endless withholding of the foreign incomes in the foreign subsidiaries („by postponing the repatriation of the foreign income“), which for sure isn't a hypothetical example, but an accurate illustration of the economic reality, the parent corporation can endlessly postpone the corporate income tax in the residence country. The withholding of the profit in the source countries initiates a huge financial (developing) problem in the residence countries. Since there is no real incentive for the MNCs to return the money from abroad, particular countries have tried with different tax „innovations“. The typical reform move for a mobilisation of the capital from abroad is a radical reduction of the tax rate on all the repatriated income amounts, that is time limited (by the rule, to one year). The big expectations have, by the rule, been betrayed. The atypical tax relaxation has really encouraged the MNCs to maintain the money abroad, because it has strengthened the expectations that a similar „offer“ of the government will be repeated in the future. The typical example is the USA, the global promoters of the credit method, who rose the „repatriation tax policy“ into the rank of an instrument for improvement of the international competition : ...The proportion of income earned abroad has increased significantly in recent years ... Industry sectors that must invest continuously in long term R&D are severely handicapped by the costs of repatriation relative to foreign country competitor corporations, many of which income from generous R&D tax credit incentives and territorial taxation systems...(Desai, Foley, Hines, 2001).

When does the withheld taxation ensure a tax saving? The answer will be given in the form of the following tax axioms:

(1) *The tax systems of the residence and the source countries are in an interactive relationship.* Each levelling of the rates in the source country, directed towards the management of the foreign investments, must have in mind that the taxation of a MNC (and its subsidiaries) should be observed integrally with the tax regime of the residence country .

(2) *A tax saving is provided by the state of the credit deficit.* A tax saving is manifested if the foreign subsidiary income is taxed (in the source country) at a lower rate than the corresponding corporate income tax in the residence country. Then, the state of a „credit deficit“ is reached („an excessive limitation“), because of the height of the credit limit for the foreign tax determined by the residence country. By contrast, when the rate of the source country is higher than the comparable tax rate of the residence country, the foreign tax of the resource country is higher than the credit limit of the residence country. Then the state of „a credit sufficite“ („an excessive credit“) is reached. The excessive credit, the difference between the corresponding tax (that is the credit limit of the residence country) and the tax of the source country, the parent MNC can use by carrying it „backwards“ into the previous tax years or „forward“ into the next tax years, when the credit deficit will possibly be shown .

(3) *“Cross taxation“ per se reduces the global tax rate, i.e., the global income tax.* If a MNC earns the income in different foreign countries, in the source countries with both low and high taxes, than the amount of the credit sufficite can be used on account and up to the amount of the credit deficite in the circumstances of a low taxed income.

**Table 2. The effects of the methods of avoiding the double taxation of a MNC  
(in monetary units, in not stated otherwise)**

<b>The method of deduction of the foreign taxes</b>	
1. The foreign tax in the residence country	1,000,000 of the taxable income x 20% = 200,000
2. The tax in the residence country	800,000 of the taxable income x 30% = 240,000
3. The worldwide income tax of the MNC	440,000
4. The worldwide tax rate of the MNC	44%
<b>The method of credit for the foreign taxes</b>	
1. The tax in the residence country	1,000,000 of the taxable income x 30% = 300,000
2. The credit for the foreign tax paid in the source country	200,000
3. The worldwide income tax of the MNC	300,000
4. The worldwide tax rate of the MNC	30%
<b>The method of exempting foreign income from domestic taxation</b>	
1. The foreign tax in the source country	1,000,000 of the taxable income x 20% = 200,000
2. The tax in the residence country	-
3. The worldwide income tax	200,000
4. The worldwide tax rate	20%

Source: counted by the author

(4) *An atypical reduction of the tax rate makes the significance of non-tax subsidies attractive.* Reductions of the tax rate (i.e., tax incentives) are the most obvious expenditure of a contemporary government whose equivalent is a subsequent loss of the tax income that the fiscus thoughtfully gives up. The basic conceptual idea is a desirable result of the disproportion between a price and an effect: a relatively smaller share of the public money induces a higher growth of the privately owned funds, consequently generating an investment progression. However, an atypical reduction of the rate significantly below the convergent rate of developed countries (Serbia, for example, on 01.01. 1999 „stepped out“ under the convergent rate of the OECD-34, with its reduction of the rate from 25% to 20%), reduces the relative importance of the very tax subsidy and makes it incentively ineffective (as soon as the tax of the source country is lower than the credit limit of the residence country, the tax requests are satisfied), and it increases the relative significance of the non-tax subsidies (that is, the remaining macroeconomic and microeconomic requests) which are to be satisfied, including also the extreme foreign requests for direct reductions of the price of doing the registered corporate activity. When we position Serbia in the role of a source country, by the final reduction of the rate to the atypically low level of 10%, the Serbian creators, identically as in Bulgaria and Cyprus EU (Ireland 12.5% - OECD), out of standard, have designed a corporate income tax, thinking that, that way it harmoniously adheres to the problem of national and international correlations of the tax systems and dynamising of the investment flows. We imply that the strategy of the continuous reduction of the rate, especially if it is applied in a small and unstable economy such as Serbia, takes away the status of an exclusive mediator of the comparative advantages for mobilising the foreign funds from the corporate income tax. Why? Instead of making the Serbian industrial area attractive and to attract foreign investments, the opposite tendency is manifested. The atypically reduced rate inhibits the tax

content and makes attractive the significance of the difference in character and incomparably imposing macroeconomic and microeconomic questions.

### *The method of exempting foreign income from domestic taxation*

From the point of view of the world economy, the double taxation is inefficient. Consequently, we conclude that the maximising of the worldwide income means that the method of deduction, i.e., the method of tax sanctioning of the foreign investments related to the tax treatment of the domestic investments, gives place to the method of credit, that is, the method of an equal treatment (tax equivalence) of both domestic and foreign investments. In the middle of the 20th century, especially during the sixth decade, the method of credit was a prestigious method in numerous countries of Europe and the USA. Favorising of the method of credit was supported by the dominant attitudes of the professional authorities of that time. The world tax scene was mastered by the common professional attitude: only the capital export neutrality enables an achievement of the goals of the economic efficiency, and it is achieved by a simultaneous application of the taxation of the worldwide income with a credit for foreign taxes (Richman - Musgrave, 1963). However, in the decades at the crossroads of the two milleniums, with intensifying of the global tendencies, the criteria for the analysis of the influence of the taxation on the investment behaviour of the corporate sector have been changed. We can criticise two sides of the method of credit. On one side, the method practically can realise discrimination of the countries of the low corporate income tax and can implicitly be manifested in the form of fiscal imperialism. On the other side, in the vortex of the European and the world changes, when the transcontinental parametres become the real ID of the economic and tax changes, numerous orthodox canons of public finances become questionable.

The global economy changed the condition of the capital taxation. The common global capital market is predominantly represented by the corresponding basic comments: The economies are open and the capital almost absolutely freely moves among the countries. If the owners of the capital in a particular country can't realise the current return rate, since the market is common, they will take the capital out of one country and invest it in another country. The implications of the tax policy are clear – if any tax was imposed on the capital, the capital „goes“ to another country, i.e., the before tax return rate must increase.

When there is no global capital market, the total amount of the capital for realisation of the domestic and foreign investments is limited. When there is a global capital market, the supply of the capital in the particular country is not limited. The big, worldwide capital market ensures that an increase of foreign investments doesn't affect the decrease of domestic investments, doesn't crowd them out (Cnossen, Sinn, 2003). Therefore, the tax on the repatriated foreign incomes doesn't increase the domestic investments, a reduction of the foreign investment, caused by the taxation, doesn't lead to an increase of the domestic investment, as it was stated by the classic lesson of public finances, but the tax rather implies that the investor gave up some investments, implicitly pointing out that the whole national economy gave certain amount of money up. If the goal of the tax policy is an increase of the national income, the tax on the repatriated incomes reduces the national income, because of what it should be abolished: the tax on the repatriated incomes leads to a reduction of the foreign activities without an increase of the domestic activity, because of which an exemption of the foreign activities from the foreign taxation incomes in the national interest .

The method of exempting foreign income from domestic taxation (the exemption method) has continuously been imposed as more adequate for sharing the international taxes, and certain European countries even apply it on the unilateral basis. The exemption method requires that the residence country transfers its taxing right to the source country, and the source country to oblige to tax the acquired income in accordance with its tax jurisdiction. Practically, a „onefold“ taxation of the international income in the source country provides the decrease of the global tax rate to the remarkably low level (20%, Table 2), compared to the size of the tax rate with the method of credit.

The entire methodology is funded by the concept of capital import neutrality, whose original logic is: a similar tax treatment of the investments in the source country regardless to the place of residence of the investor. For the full implementation of the concept of capital import neutrality is necessary: (1) the residence country to apply the fiscal principle of territory and leave out the foreign income, (2) the source country to respect the non-discrimination principle with the aim of the identical treatment of both domestic and foreign investors (The concept of capital import neutrality is the concept of public finances to describe the situation in which the investments in a country are subject to the same level of tax, regardless to whether they have been realised by either domestic or foreign investors. The exemption method relieving of the international double taxation have often been thought of to illustrate this concept, Desai, Hines, 2003).

**Table 3. The Methods of Taxation of Foreign-Source Dividends in the OECD Countries, 2010**

<b>Method of Taxation</b>	
<b>1. Territorial Tax Systems</b>	<b>Exempt foreign - source dividends from domestic taxation through territorial tax system<sup>1</sup></b>
Dividend Exemption Percentage	OECD Countries with Territorial Tax Systems
100% exemption	Australia, Austria, Canada, Czech Republic, Denmark, Estonia, Finland, Greece, Hungary, Iceland, Luxembourg, Netherlands, New Zealand, Portugal, Slovak Republic, Spain, Sweden, Switzerland, <sup>2</sup> Turkey, United Kingdom
97% exemption	Norway
95% exemption	Belgium, France, <sup>3</sup> Germany, Italy, Japan, Slovenia
<b>2. Worldwide Tax Systems</b>	<b>Worldwide system of taxation with foreign tax credit</b>
Dividend Exemption Percentage	OECD Countries with Worldwide Tax Systems
	Country    2010 Tax Rate <sup>4</sup>
0% exemption	Ireland    12.50%
	Chile    17.00%
	Poland    19.00%
	Korea    24.20%
	Israel    25.00%
	Mexico    30.00%
	United States    39.21%

<sup>1</sup> In general, territorial tax treatment providing exemption of foreign-source dividends depends on qualifying criteria (e.g., minimum ownership level, minimum holding period the source country, and/or the source country tax rate).

<sup>2</sup> The effective exemption may be reduced by up to 5% as a proxy for general and administrative expenses.

<sup>3</sup> The exemption percentage is at least 95%, but can be higher.

<sup>4</sup> Refers to generally applicable tax rate, including surcharges, of combined central and sub-central government taxes.

Source: McDonald R.A. (2010). *Roadmap for Growth*, Washington: Business Roundtable

What are the practical tendencies with the respect to (de) favouring of the method of credit or the method of exempting? The USA are the last highly developed country that has still been favouring

## THE INTERACTION OF THE PROCESS OF TAXATION AND THE INTERNATIONAL TRANSACTIONS

---

the method of credit (the United Kingdom recently abolished the method of tax credit and adopted the tax exemption method). Why is there a massive adoption of the exemption method? The exemption method and the new repatriation tax policy are preferred from a few typical reasons: (1) The exemption method improves the international competition. (2) A reduction/abolition of the tax on repatriated profits means the adoption of the territorial tax system (the system with a very low or a zero rate on repatriated profits). (3) The funds, that would otherwise be „captured“ abroad, would be returned to the residence country. This cash would provide an immediate incentive for taking new projects and accelerating the pace of the economic recovery.

### Conclusion

The world economy is disproportionately divided about the question of choice of the „right“ method of the international taxation, as a representative of its own national interests. On one side is a group of 7 countries, led by the USA, which advocates for the method of credit, that is, the method which conceptually means an equivalent tax treatment of the domestic and the foreign income. On the opponent side, there is a group of 27 countries which favour the method of exemption, that is the method which conceptually means a preferential tax treatment of the foreign income.

The USA is the only renowned country that taxes a MNCs on the basis of its worldwide income. The remaining six countries, apart from Ireland, realise few foreign investments, which all together don't reach 2% of the world's outward foreign investment in 2009 (Becker, 2010). While the USA persists on the method of credit, Japan and the UK conducted a tax innovation. In just three previous years, both countries moved to the territorial tax system, justifying this change as a form of an effective improvement of the competition of their economies. Similar to the previous tendencies, the political elite in Germany says that the government will force the method of exemption to support the competition of German companies.

Based on, in the paper enclosed arguments, including the marked practical trends that dominate through the tax-methodological content, finally we conclude: If the competition of the domestic economic actors is the primary goal of the tax (economic) policy of a country, then the exemption of their income earned abroad from the domestic process of taxation, is the best methodological answer, because it minimises the corresponding global tax burden, that is, because it represents a comparative advantage for the global business performance of the MNCs.

### Acknowledgments

This paper is a part of research project No. 41010 (Pre-clinical testing of bioactive substances), financed by the Ministry of Science and Technological Development of the Republic of Serbia.

### References

- Becker, J. (2010). Strategic Trade Policy through the Tax System, *CESifo Working Paper* No 3066.
- Brys, B., S. Matthews and J. Owens. (2011). Tax Reform Trends in OECD Countries, *OECD Taxation Working Paper*, No 1.
- Cnossen, S. and H. Sinn. (2003). *Public Finance and Public Policy in the New Century*, Cambridge: MIT Press.
- Desai, M., F. Foley. and Hines, R.J. (2001). Repatriation Taxes and Dividend Distortions, *NBER Working Paper* No. 8507.

- Desai, M. and R.J. Hines. (2003.) Evaluating International Tax Reform, *Harvard NOM Research Paper* No. 03-48.
- Desai, M. (2009). Securing Jobs or the New Protectionism?: Taxing the Overseas Activities of Multinational Firma, *Harvard University and NBER Working Paper*.
- McDonald, R.A. (2010). *Roadmap for Growth*, Washington: Business Roundtable.
- Monsenego, J. (2011). *Taxation of Foreign Business Income within European Internal Market*, Dissertation for the Degree of Doctor of Philosophy, Ph.D., Stockholm School of Economics.
- Musgrave, P. (1969). *United States Taxation of Foreign Investment Income: Issues and Arguments. International Tax Program*, Harvard Law School.
- Musgrave, R. (1973). *Teorija javnih finansija*, Beograd: Naučna knjiga.
- Musgrave, R. And P. Musgrave. (1989). *Public Finance in Theory and Practice*, New York: McGraw Hill
- OECD. (1995, 2010). *Model Tax Convention on Income and on Capital*, Paris: OECD Publishing.
- OECD. (2012). OECD Database, *Taxation of Corporate and Capital Income* (update with 2012 data), Paris: OECD Publishing.
- Richman (Musgrave), P. (1963). *Taxation of Foreign Investment Income: An Economic Analysis*, Baltimore: Johns Hopkins University Press.
- Yeaple, S. (2008). Firm Heterogeneity and the Structure of US Multinational Activity: An Empirical Analysis, *NBER Working Paper* No. 14072





# EXCHANGE RATE REGIMES AND REAL EXCHANGE RATE IN THE WESTERN BALKAN COUNTRIES

Vasilj Žarković<sup>1</sup>

Dragan Gligorić<sup>2</sup>

Jelena Tešić<sup>3</sup>

**Abstract:** *At the beginning of the transition process Western Balkan countries have chosen certain exchange rate regimes in order to achieve macroeconomic stability and restore confidence in a local currency. Since the beginning of transition, macroeconomic goals of stabilization have been achieved, while constant fundamental economic problems are high unemployment rate and relatively high deficits of the current accounts. Some countries have abandoned fixed exchange rate regimes in order to put monetary policy into the function of economic growth. This paper investigates whether monetary policy geared towards more flexible regimes can mitigate the trend of appreciation of the real exchange rate in the countries of Western Balkans. Preliminary research suggests that monetary policy based on more flexible regimes can mitigate appreciation trend, but abandoning of fixed and application of flexible exchange rate regime in the condition of insufficient institutional and overall development can threaten macroeconomic stability.*

**Keywords:** *exchange rate regimes, real exchange rate, monetary policy.*

## Introductory considerations

One of the most important issues for the economic policy-makers is to understand the impact of the choice of exchange rate regime on macroeconomic performances of national economy. According to the classification of International Monetary Fund, there are eight types of official (de facto) exchange rate regimes, sorted by increasing flexibility: exchange arrangement with no separate legal tender, currency board arrangement, conventional fixed peg arrangement, pegged exchange rate within horizontal bands, crawling peg, crawling band, managed floating with no pre-determined path for the exchange rate and independently floating.

Regarding the macroeconomic effects of the exchange rate regimes there are lot of contradictory statements. Proponents of fixed regimes point out that stable exchange rates have positive effects on the inflation, interest rates, foreign investments and international trade, and hence on overall economic growth. Proponents of more flexible regimes (Levy-Yeyati and Sturzenegger, 2002) state that in the events of the external shocks, inability to adjust the nominal exchange rate within a fixed regimes leads to a slower adjustment of the real exchange rate and hence to the distorted prices and misleading allocation of resources.

The beginning of transition process in the Western Balkan countries had been marked by the high inflation which forced countries to adopt stabilization policies based on exchange rates whose main goal was to curb inflation and ensure macroeconomic stability. For these reasons, Bosnia and Herzegovina adopted currency board regime, while Croatia and Macedonia firmly pegged their currencies, first to the German mark, and after to euro with possibility of small oscillations.

---

<sup>1</sup> Faculty of Economics University of Banja Luka, vasilj.zarkovic@efbl.org

<sup>2</sup> Faculty of Economics University of Banja Luka

<sup>3</sup> Faculty of Economics University of Banja Luka

## EXCHANGE RATE REGIMES AND REAL EXCHANGE RATE IN THE WESTERN BALKAN COUNTRIES

---

Montenegro introduced German mark, and after euro as a legal tender. Monetary authorities in Serbia, after democratic reforms in 2000 said that they would adopt the managed floating regime with targeting exchange rate as a nominal anchor (*de jure*). However, *de facto* exchange rate regime until early 2003 was fixed. In Albania, in the beginning of 90-ies, the free floating was adopted with targeting the growth of monetary supply.

In the previous period, the goals of low inflation and macroeconomic stability in the Western Balkans have been achieved. Despite these positive features, there are also the negative ones which are characterized by the high current account deficits despite the high unilateral transfers in form of pensions and workers' remittances. This means that productivity growth and high capital inflows from abroad failed to provide adequate competitiveness of domestic product and services in the international market, which in the long run could lead to the over-indebtedness.

Numerous studies on the examples of developing countries have confirmed positive relation between capital inflows, workers' remittances and pensions from the one side and appreciation of real exchange rate from the other (Agenor and Hoffmaister, 1996; Acosta, et al, 2007). Monetary policy is one of the economic policies which certainly may affect the movement of the real exchange rate (Ball, et. al., 2010; Combes, et al., 2011).

Given the existence of different exchange rate regimes in the Western Balkan countries, and the fact that the region is influenced by the factors that could cause appreciation of the real exchange rate, we set the following problem: *Does the choice of exchange rate regime influence the level of appreciation of the real exchange rate in the Western Balkan countries?*

The subject of the paper is to analyze the impact of exchange rate regime on the real exchange rate. Empirical analysis covers the period from 1999 to 2009 which is long enough to enable the objective conclusions. Given the fact that the crisis has significantly changed trends of economic parameters that influence real exchange rate, movements of the real exchange rate have not been analyzed in the period after 2009. Hypothesis that attempts to be proven is the following claim: *Application of more flexible exchange rate regimes is connected with the lower level of appreciation of real exchange rate in the Western Balkan countries.*

### Real exchange rate – conception and methodology of calculation

Real exchange rate is the product of the nominal exchange rate and the ratio of the foreign and domestic prices, i.e.  $E^R = E \frac{P^*}{P}$ , where E stands for nominal exchange rate, P\* for the level of prices abroad and P for the level of domestic prices. According to the theory of purchasing power parity nominal exchange rate is  $E=P/P^*$ . If the nominal exchange rate is at the level predicted by PPP theory, this implies the real exchange rate of 1. If it is less than 1, domestic currency is overvalued, i.e. nominal exchange rate should be higher so the real exchange rate is 1. If the real exchange rate is greater than 1, domestic currency is overvalued.

In the literature, real exchange rate is more often used in order to express its dynamism and not only overvaluation or undervaluation of the currencies. It means that its calculation relies on the relative purchasing power parity theory, where P is the price index in country and P\* price index abroad. Dynamism of real exchange rate is the subject of empirical part of the paper.

Such approach provides the possibility of calculating exact changes in the real exchange rate because relative PPP can be true even when absolute PPP is not valid. This arises from the fact that price index better represents dynamism of price movements than the value of basket of goods represents overall price level. In such a way we can measure dynamism of the real exchange rate compared to certain base period ( $E^R=100$ ) without obligation to determine whether in a base period

domestic currency was overvalued or undervalued. Real exchange rate appreciated in certain period compared to the base period if the index of real exchange rate is less than 100 and depreciated if the index of real exchange rate is greater than 100. Depreciation of the real exchange rate, i.e. the growth of the real exchange rate index makes foreign products more expensive compared to domestic products. Conversely, appreciation of the real exchange rate makes foreign products cheaper than domestic products. Thus, the real exchange rate is the determinant of price competitiveness of the national economy.

In the previous formula, real exchange rate is defined as the nominal exchange rate multiplied by the quotient of the foreign and domestic prices. Nominal exchange rate is hence a number of domestic currency units needed for purchasing one unit of foreign currency and foreign prices relate only to one country. Real exchange rate as such represents bilateral real exchange rate. If we want to look at the movement of the real exchange rate compared to many countries, it is necessary to calculate nominal effective exchange rate first and then real effective exchange rate. Nominal Effective Exchange Rate – NEER is calculated as a weighted average of bilateral nominal exchange rates (Nominal Bilateral Exchange Rates - NBER). We use share of trade of a country which is among the main trading partners in the total foreign trade of a country for which we calculate the real effective exchange rate. For calculating this ponder, we use formula  $\alpha_i = \frac{X_i + M_i}{\sum (X_i + M_i)}$ , where X

represents export and M imports in a country i. The weights are calculated cumulatively for the whole period from 1999 to 2009. NEER is calculated using the geometric mean. Average annual bilateral nominal exchange rates (E) of the main trading partners (directly noted) are firstly converted to the base index of bilateral nominal exchange rate NBER, 1999=100. Thus, the usage of geometric mean is made solely on the indices rather than the value of the exchange rate which enables to neutralize the impact of the different values of the different currencies. Therefore, the base value of index in year t is  $NBER_t = (E_t/E_0) * 100$ .

By weighting NBER in a certain year with the usage of geometric mean we get base index NEER (1999=100) in year t, i.e.

$$NEER_t = (NBER_{1t})^{\alpha_i} * (NBER_{2t})^{\alpha_i} * \dots * (NBER_{nt})^{\alpha_i} \text{ where } i \text{ goes from } 1 \text{ to } n.$$

Index of Real Effective Exchange Rate is calculated based on NBER. We firstly calculate Real Bilateral Exchange Rates - RBER by multiplying NBER with CPI (annual average, with the same base as NBER) in certain foreign country, and then by dividing it with CPI in the country for which the real exchange rate is calculated. Hence,  $RBER_t = NBER_t * CPI_{it}/CPI_i$ . By weighting RBER with the usage of geometric mean we get base index of the real effective exchange rate REER<sub>t</sub>, i.e.

$$REER_t = (RBER_{1t})^{\alpha_i} * (RBER_{2t})^{\alpha_i} * \dots * (RBER_{nt})^{\alpha_i} \text{ where } i \text{ goes from } 1 \text{ to } n.$$

### **Real exchange rates and exchange rate regimes in the Western Balkan countries**

We have defined exchange rate regime according to de facto classification of International Monetary Fund. In the following parts we present the movements in nominal and real exchange rate index (NEER and REER) in the Western Balkan countries in context of applied de facto exchange rate regimes in each country in the covered period.

#### ***Montenegro***

Based on the available data, it was possible to calculate ponders of foreign trade in goods only in the period from 2003 to 2009. We use these ponders for the whole period of calculation of the real

## EXCHANGE RATE REGIMES AND REAL EXCHANGE RATE IN THE WESTERN BALKAN COUNTRIES

effective exchange rate. Main foreign trade partners represent 73% of total foreign trade of Montenegro.

The Graph no 1 shows the indices of nominal and real effective exchange rate, NEER and REER in the period from 1999 to 2009. Decline in the index indicates appreciation while the rise in the index indicates depreciation of the exchange rate. The Graph shows that the movements of REER are mainly caused by the movements of NEER since these two lines almost overlap each other. A steep decline of both indices in 2000 compared to 1999 was caused by the nominal exchange rate movements in Serbia. Namely, average exchange rate of Serbian dinar in 1999 amounted 11,74 dinars for one euro, while in 2000 amounted 49,67 for one euro. The aforementioned movement arose because until 2000 in Serbia there was a black exchange market, and the official exchange rate has been overvalued compared to the “market” value. Monetary authorities in Serbia devaluated dinar and then allowed a more significant impact of the market movements on its formation. Due to great ponder of exchange rate of dinar in calculating index of effective exchange rate for Montenegro, devaluation of dinar in 2000, and later depreciations of dinar, caused sudden appreciation of both indices in Montenegro.

**Graph No 1. Nominal and real exchange rate indices in Montenegro**

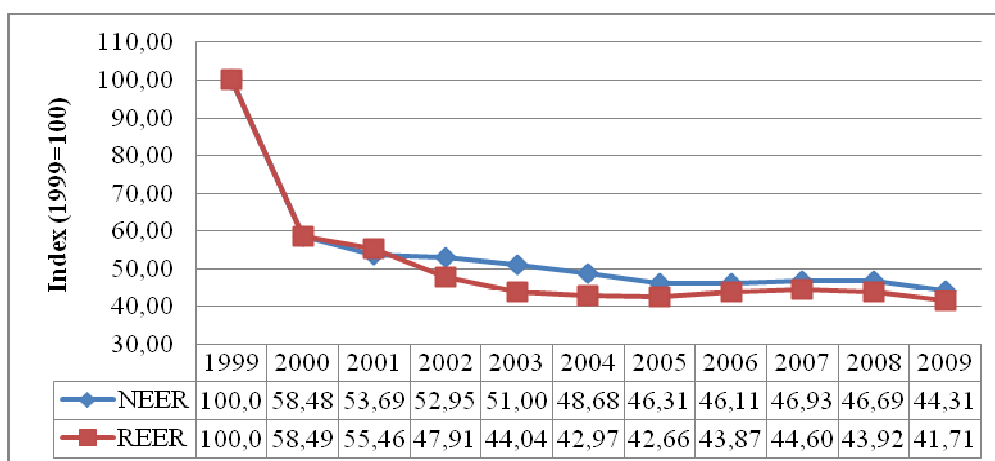

Source: Calculation of authors

After the initial appreciation of both indices, their convergence is visible from 2000. The reason for this convergence is the lower inflation rate in Montenegro, mainly due to euroization. However, relatively high inflation rates that countries experience after the introduction of rigid exchange rate regimes because of the “inflation inertia” can significantly contribute to appreciation of the real exchange rate which has been confirmed also in the case of Montenegro in the period from 2001 to 2006. The influence of the difference between inflation in Montenegro and inflation in its main foreign trade partners can be seen from the Graph 1. Greater difference in inflations automatically leads to the greater difference between REER and NEER. The difference is more vivid in the period from 2001-2006. In the period from 2006 to 2009, movements of both indices is the same which is caused by the smaller difference in inflation rates shown in the Table 1.

We can conclude that the appreciation of NEER, and hence REER was caused mainly by the rise of nominal value of euro in covered period compared to the values of currencies which are the

main foreign trade partners of Montenegro – Serbia, Greece, China and Slovenia<sup>4</sup>. Difference between NEER and REER cumulatively for the period from 1999 to 2009 amounts only 2,6% (44,31-41,71). This indicates to the negative effects of the monetary policy of the anchor country in the country with fixed exchange rate, i.e. in the country that adopts a foreign currency as a legal tender.

**Table No 1. Inflation difference between Montenegro and its main foreign trade partners (annual average, in %)**

Year	2000	2001	2002	2003	2004	2005	2006	2007	2008	2009
Inflation in Montenegro	24,8	23,7	19,7	7,5	3,1	3,4	3,0	4,2	8,5	3,4
Weighted inflation abroad	24,8	27,8	4,9	2,6	5,4	7,9	6,4	4,1	7,4	3,5
Difference	-0,03	-4,03	14,83	4,92	-2,31	-4,50	-3,38	0,13	1,09	-0,05

Source: <http://www.imf.org/external/pubs/ft/weo/2012/02/weodata/index.aspx> (access, October 2012.)

### *Bosnia and Herzegovina*

The main foreign trade partners whose exchange rates and inflations have been used in calculating NEER and REER represent 77% of total foreign trade of BiH in the period from 1999 to 2009. Graph 2 shows movements in NEER and REER indices. Sudden appreciation of both indices in 2000 compared to 1999 was caused by devaluation of Serbian dinar as in the case of Montenegro. Devaluation and depreciation of dinar and its great impact on the real effective exchange rate of convertible mark (weight of 0,15) lead to the appreciation of NEER and REER indices. Convertible mark (KM) has appreciated more in nominal than in the real terms during the period. Higher indices, and smaller appreciation of the real effective rate compared to the nominal one, can be result only of the lower inflation in the country compared to the weighted inflation in the main foreign trade partners. Table No 2 shows this tendency. Inflation rates in BiH are solid, and due to this factor, BiH has significantly mitigated impact of nominal appreciation on the real appreciation.

**Graph No 2. Nominal and real exchange rate indices in BiH**

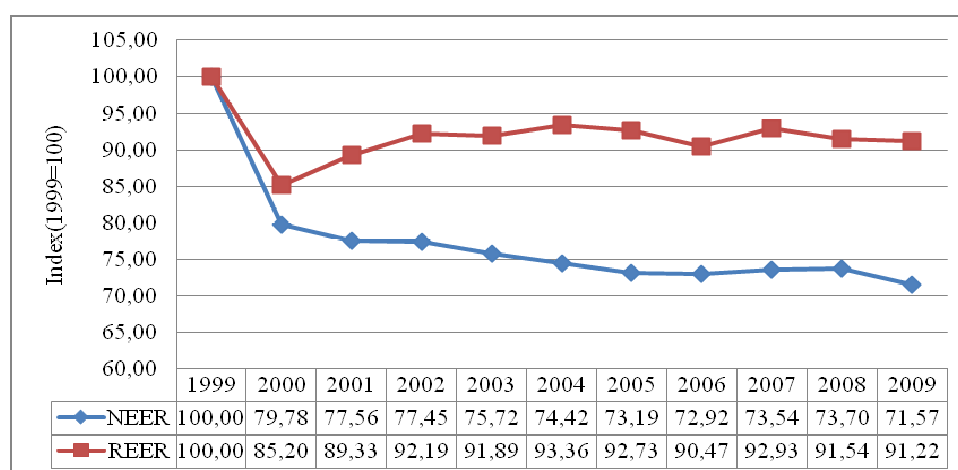

Source: Calculation of authors

<sup>4</sup> Greece is member of European Monetary Union form 2001 and Slovenia form 2007. Before entering eurozone currencies of these two countries depreciated against euro.

## EXCHANGE RATE REGIMES AND REAL EXCHANGE RATE IN THE WESTERN BALKAN COUNTRIES

Lower inflation compared to the inflation abroad was achieved during the whole period, except in 2006. and 2008. Nominal appreciation of KM arose primarily due to the depreciation of exchange rates in Serbia, Slovenia and Hungary, which is evident from the movements of the bilateral real exchange rates between KM and aforementioned currencies.

**Table No 2. Inflation difference between BiH and its main foreign trade partners  
(annual average, in %)**

Year	2000	2001	2002	2003	2004	2005	2006	2007	2008	2009
Inflation in BiH	4,92	4,63	0,31	0,55	0,28	3,58	6,13	1,50	7,43	-0,38
Weighted inflation abroad	12,1	12,8	3,7	2,5	3,7	4,6	3,9	3,4	5,6	2,2
Difference	-7,14	-8,20	-3,36	-1,96	-3,39	-1,03	2,21	-1,88	1,84	-2,61

Source: <http://www.imf.org/external/pubs/ft/weo/2012/02/weodata/index.aspx> (access, October 2012.)

After the initial appreciation of KM, from 2002, index of real effective exchange rate is stable and its average is 92,04 with the standard deviation of only 0,96%.

### Macedonia

The main foreign trade partners and correspondent partners used in calculation of NEER and REER, represent 71% of total foreign trade of Macedonia. As in the case of Montenegro and BiH, exchange rate of dinar has a great impact on the movements of nominal and real effective exchange rate of Macedonian currency denar. Graph No 3 shows movements in NEER and REER indices. In 2000 denar appreciated sharply due to the devaluation and depreciation of Serbian dinar. In almost all other years there is a constant depreciation of REER, despite the fact that NEER has significantly appreciated in the covered period.

**Graph No 3. Nominal and real exchange rate indices in Macedonia**

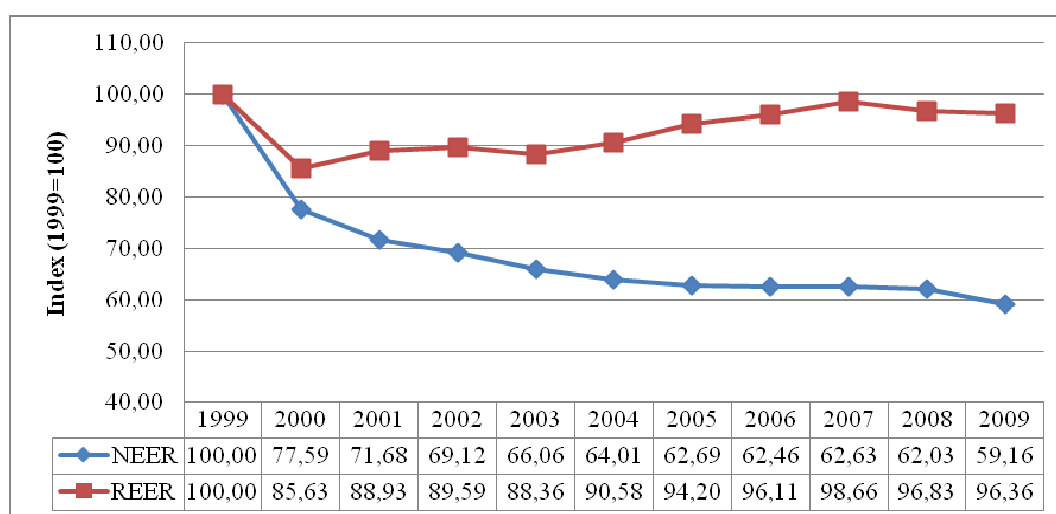

Source: Calculation of authors

Depreciation of REER despite the appreciation of NEER is the result of low level of inflation in Macedonia compared to the weighted inflation abroad, what is shown in the Table No 3.

**Table No 3. Inflation difference between Macedonia and its main foreign trade partners  
(annual average, in %)**

Year	2000	2001	2002	2003	2004	2005	2006	2007	2008	2009
Inflation in Macedonia	6,39	5,54	2,18	1,20	-0,43	0,49	3,21	2,26	8,36	-0,8
Weighted inflation abroad	17,40	18,65	6,75	4,43	5,34	6,70	5,70	4,67	7,38	3,50
Difference	-11,01	-13,11	-4,57	-3,2	-5,8	-6,2	-2,5	-2,4	0,97	-4,3

Source: <http://www.imf.org/external/pubs/ft/weo/2012/02/weodata/index.aspx> (access, October 2012.)

Inflationary difference is negative in all years except in 2008. Average annual inflationary difference is greater in Macedonia than in the BiH, -5,22% compared to -2,55%. Greater (negative) inflationary difference in Macedonia is not the result of lower inflation since CPI in 2009 for Macedonia is 131,76, and for BiH 132,58. It is caused by the fact that the main foreign trade partners of Macedonia have on average higher inflation than the foreign trade partners of BiH.

### *Croatia*

Croatia has greater dispersion of trade in goods, and it was necessary to take into account 16 foreign trade partners in order to cover 70% of total foreign trade in the period from 1999 to 2009. In contrast to previously analyzed countries, in Croatia there are no sudden oscillations of the nominal and real exchange rate index in 2000, since Serbian has small weight in calculating NEER and REER. REER index appreciated less than NEER, because of the relatively smaller inflation rates in Croatia (average annual rate is -0,26%) than abroad. Inflationary difference is shown in the Table No 4.

**Table No 4. Inflation difference between Croatia and its main foreign trade partners  
(annual average, in %)**

Year	2000	2001	2002	2003	2004	2005	2006	2007	2008	2009
Inflation in Croatia	4,63	3,76	1,67	1,77	2,03	3,34	3,21	2,87	6,07	2,38
Weighted inflation abroad	5,10	5,21	3,34	2,85	2,98	3,02	2,86	2,98	4,61	1,35
Difference	-0,47	-1,45	-1,67	-1,08	-0,95	0,32	0,34	-0,10	1,46	1,03

Source: <http://www.imf.org/external/pubs/ft/weo/2012/02/weodata/index.aspx> (access, October 2012.)

If we compare NEER and REER in Croatia compared to previously analyzed countries we can see that the indices in Croatia have not appreciated to greater extent but there is constant and gradual nominal and real appreciation of kuna. Reason of nominal appreciation is strengthening of euro against other currencies which is reflected also on kuna. Namely, from 1 of September 2006 de facto regime was reclassified from managed floating with no pre-determined path into conventional fixed regime which means smaller oscillation of kuna against euro and consequently, a greater impact of nominal appreciation of euro on kuna.

## EXCHANGE RATE REGIMES AND REAL EXCHANGE RATE IN THE WESTERN BALKAN COUNTRIES

After de facto exchange rate regime was changed in 2006, REER index appreciated more compared to NEER, and REER line become steeper. There is an opposite trend in the period of managed floating regime. The reason could be the fact that more fixed regimes imply smaller impact on the amount of money in circulation (for example, smaller possibility of “sterilization” of capital inflows) because monetary policy is more committed to maintain exchange rate within allowed margins of fluctuations. In this way, eventual capital inflows have greater impact on increase of monetary supply, because central bank is forced to sell domestic currency in order to keep nominal exchange rate within allowed margins. In Table 4 we can notice that inflation in Croatia become higher than weighted average of inflation in foreign trade partners after introduction of de facto more rigid exchange rate regime.

**Graph No 4. Nominal and real exchange rate indices in Croatia**

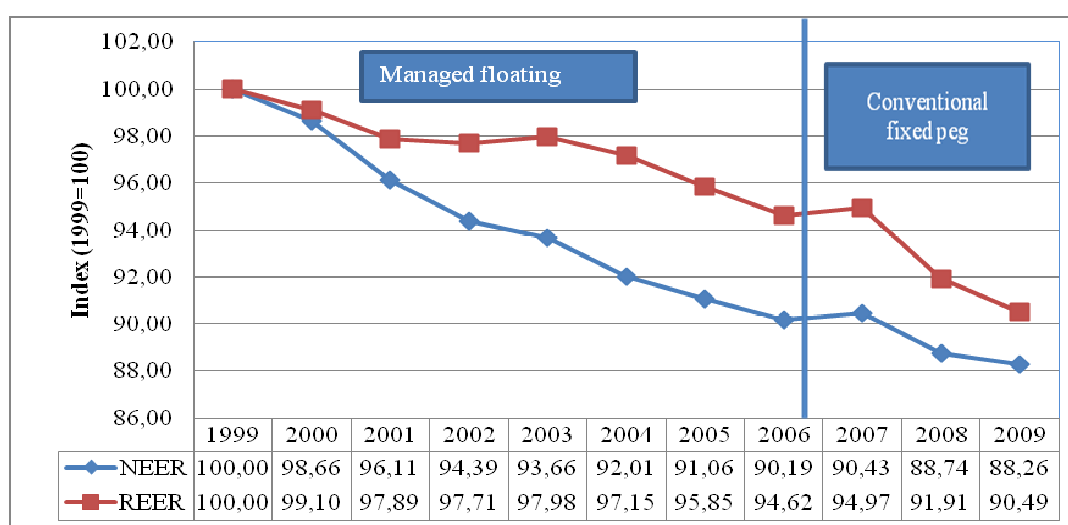

Source: Calculation of authors

### Serbia

As in the case of Croatia, great dispersion of trade in goods required inclusion of 13 foreign trade partners in calculation of NEER and REER. Serbia had been changing its exchange rate regime in analyzed period several times. Until August 2006 the exchange rate had been used as a nominal anchor, after Serbia had changed exchange rate regime to managed floating with targeting of inflation. From the beginning of the covered period until October 2000 official exchange rate was 6 dinars for one euro. According to this exchange rate, dinar was overvalued which caused emerging of black market and the need for foreign exchange controls.

In October 2000 official exchange rate was 6 dinars for one euro while unofficial was 30 dinars for one euro. After this there is a shift in monetary policy in Serbia. „First step of the new monetary authorities was the acceptance of reality in terms of the acceptance of previously unofficial exchange rate in the beginning of December 2000. Dinar was devaluated by 80% against the German mark and official rate was 30 DIN/DM“ (Beker, 2010) .

After the shift in monetary policy there is a period of much greater stability of REER and NEER indices. Appreciation of REER has been moderate. The highest value of REER which means the highest price competitiveness was in the period of crawling peg. With the shift to managed floating with inflationary targeting there was a slight decline, i.e. appreciation of REER.



**Graph No 5. Nominal and real exchange rate indices in Serbia**

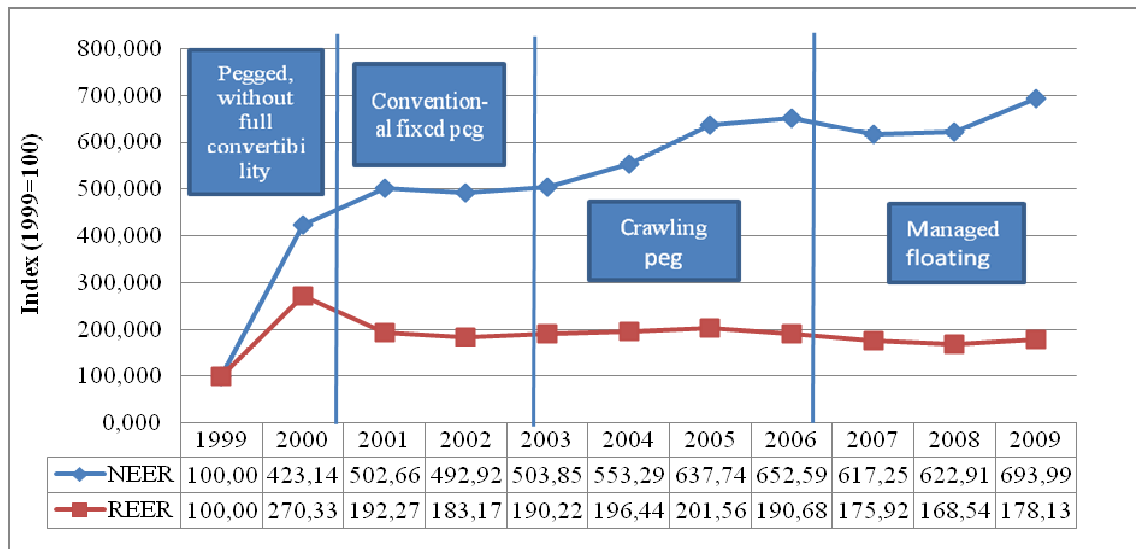

Source: Calculation of authors

Index of nominal effective exchange rate has been constantly growing throughout the period, which is the result of a loose monetary policy in Serbia. The evidence for this claim is the decline of bilateral nominal exchange rate index against all trading partners. Although the nominal depreciation lead to the real depreciation at the beginning of period, from 2002 nominal depreciation was transferred into the rise of prices (so called pass-through effect of exchange rate on inflation) which is shown in the next Table.

**Table No 5. Inflation difference between Serbia and its main foreign trade partners (annual average, in %)**

Year	2000	2001	2002	2003	2004	2005	2006	2007	2008	2009
Inflation in Serbia	70,00	80,60	8,86	2,91	10,61	17,28	12,67	6,50	12,43	8,11
Weighted inflation abroad	8,61	8,13	5,75	4,55	4,02	4,41	4,16	3,88	6,73	2,56
Difference	61,39	72,47	3,10	-1,64	6,59	12,88	8,51	2,62	5,69	5,55

Source: <http://www.imf.org/external/pubs/ft/weo/2012/02/weodata/index.aspx> (access October 2012)

Inflationary difference was dramatically reduced from 2006 when exchange rate regime was changed into managed floating with inflationary targeting. Nominal exchange rate against euro in 2007 compared to 2006 appreciated from 84,16 to 79,96 dinars for one euro. Also, in 2007, Serbia achieved the lowest inflation and inflationary difference. It shows again the existence of “pass-through” effect and relatively small impact of monetary policy on the real exchange rate through nominal exchange rate.

**Albania**

The main foreign trade partners of Albania whose trade was used in calculating ponders for NEER and REER represent 77% of total foreign trade in goods of Albania. In the analyzed period

## EXCHANGE RATE REGIMES AND REAL EXCHANGE RATE IN THE WESTERN BALKAN COUNTRIES

Albania had achieved very low inflation rates which enabled it smaller appreciation of REER compared to NEER, as it is obvious from the Graph and Table 6.

**Table No 6. Inflation difference between Albania and its main foreign trade partners (annual average, in %)**

Year	2000	2001	2002	2003	2004	2005	2006	2007	2008	2009
Inflation in Albania	0,04	3,12	5,22	2,34	2,87	2,36	2,37	2,94	3,36	2,22
Weighted inflation abroad	6,42	6,39	5,69	4,48	3,22	3,23	3,27	3,22	4,86	1,49
Difference	-6,38	-3,27	-0,47	-2,1	-0,35	-0,87	-0,90	-0,28	-1,50	0,73

Source: IMF, World Economic Outlook Database, April 2011, and calculation of authors

In Albania there is de facto the most flexible exchange rate regime compared to other Western Balkan countries, and that is independently floating. Exchange rate regime had not been changed during the analyzed period, but in the beginning of 2000 they started with shift from direct control of interest rate to the indirect instruments of monetary policy. Inflation rates (average consumer prices) had not been exceeding amount of 3,36% annually except for 2002 when it was higher due to the crisis in banking sector.

The greatest appreciation of both indices was in the period of application of direct controls of interest rates, i.e. until 2002. Only in two year, real exchange rate appreciated for almost 10%. After 2002 there is a high correlation between indices of REER and NEER (correlation coefficient is 0,97), which indicates the ability of Albanian Central Bank to influence the real exchange rate, i.e. foreign price competitiveness. When average exchange rate of lek against euro in 2009 depreciated compared to 2008 from 62,78 to 67,52 (annual average), real exchange rate depreciated as well. The value of REER index in 2008 was 84,74 and in 2009 it was 89,52. Empirical analysis of other authors in case of Albania identified also decreasing trend of “pass-through” effect in the period from 2000 to 2006 (Istrefi and Semi, 2007). This indicates that the instruments of monetary policy in Albania could be used more for the purposes of economic growth than in other countries o Western Balkans.

**Graph No 6. Nominal and real exchange rate indices in Albania**

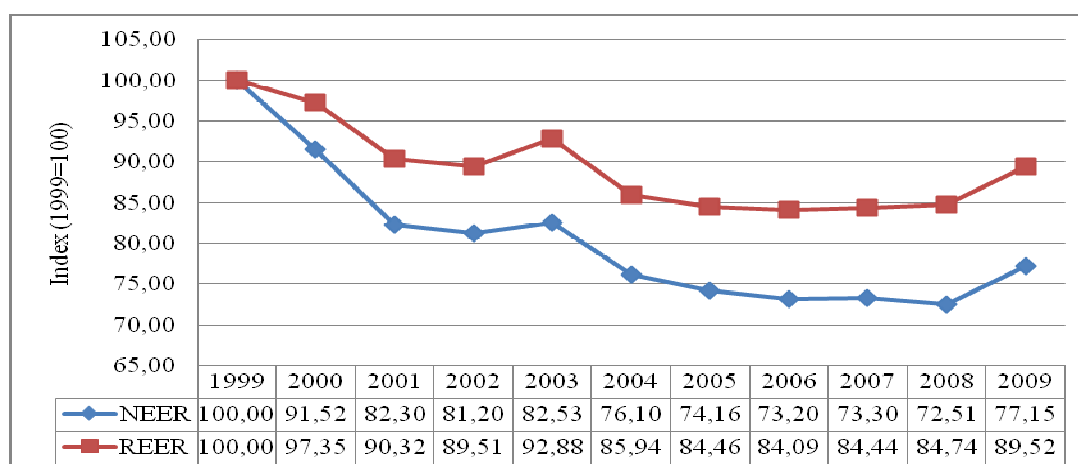

Source: Calculation of authors

## Conclusion

The issue of choice of exchange rate regime is currently one of the most pressing issues in the field of monetary and international economics. Most researchers agree that there is no optimal exchange regime for one country in all times. The consensus emerges also regarding the fact that fixed regimes are effective instrument in achieving macroeconomic stabilization in the initial stages of transition period. This implies that moving towards more flexible regimes during the later developmental period should be followed.

An analysis of real effective exchange rate in countries of Western Balkans shows that in all countries, except Serbia, there is a trend of appreciation of exchange rate in the period from 1999 to 2009. In the cases of Serbia and Albania which have flexible regimes, we examined ability of monetary policy to mitigate the trend of appreciation of real exchange rate. Shift from the crawling peg to managed fluctuation in 2006 in Serbia have not resulted in depreciation of real exchange rate, despite the nominal depreciation of dinar against euro. The reason is strong transmission mechanism of the change in nominal exchange rate on the level of prices. An analysis of the movements in nominal exchange rate of Albanian lek against euro and the movement of REER, when lek depressed from 62,78 to 67,52 lek for one euro which caused depreciation of real effective exchange rate from 84,74 to 89,52 shows that changes in nominal exchange rate can lead to a smaller appreciation of REER.

Exchange rate regimes in Macedonia and Croatia also leave some room for changes in nominal exchange rate, but this possibility had not been used. Macedonia had not had a big need for this kind of policy due to a small appreciation of the real exchange rate, while Croatia had not used this possibility. High level of informal euroization that exists in Croatia and the risk of banking crisis in the case of eventual nominal depreciation had probably been the factor for such inactive exchange rate policy.

Bosnia and Herzegovina and Montenegro do not have possibility to influence the price competitiveness by the changes in nominal exchange rate. In rigid regimes which function in these two countries, the only way to maintain competitiveness is to curb inflation. Bosnia and Herzegovina had mitigated the trend of appreciation of real effective exchange rate due to the low level of inflation. Montenegro had greater appreciation of the real exchange rate and greater inflation rates than BiH, but there is trend of reducing inflation in a last few years.

Our research suggests that monetary policy geared towards more flexible regimes can mitigate the trend of appreciation, but abandoning of fixed and application of more flexible exchange rate regimes in the condition of insufficient institutional and overall development can threaten macroeconomic stability. Moreover, in the cases of BiH and Montenegro it is shown that good inflation performances can also mitigate the trend of appreciation of real exchange rate in the countries with more rigid exchange rate regimes.

## References:

- Acosta, A. P., Lartey, E. K.K., Mandelman, F.S., (2007), *Remittances and the Dutch Disease*. Atlanta: Federal Reserve Bank
- Agenor, P-R., Hoffmaister, A.W. (1996), Capital inflows and the real exchange rate: analytical framework and econometric evidence. San Francisco: Federal Reserve Bank
- Ball, C. P., Cruz-Zuniga, M., Lopez. C., Reyes, J., (2010), *Remittances, Inflation and Exchange Rate Regimes in Small Open Economies*. MPRA Paper No. 22648

## EXCHANGE RATE REGIMES AND REAL EXCHANGE RATE IN THE WESTERN BALKAN COUNTRIES

---

- Beker, E. P., (2010). Upravljano fluktuiranje deviznog kursa u režimu inflacionog targetiranja u tranzicionim ekonomijama s osvrtom na Srbiju. Dostupno na: <http://www.uns.ac.rs/sr/doktorske/emilijaBekerPucar/disertacija.pdf>, (pristup 22.01.2011.)
- Combes, J.L., Kinda, T., Plane, P., (2011), *Capital Flows, Exchange Rate Flexibility, and the Real Exchange Rate*, IMF Working Paper, WP/11/9.
- Diev, P., Kurtz, E. (2003), Capital inflows, monetary policy and exchange rate regime in New Member States, for the accession to the euro area. Paris: Banque de France
- Istrefi, K., Semi, V., (2007), Exchange rate pass-through in Albania. Bank of Albania
- Levy-Yeyati E., Sturzenegger, F., (2002), Classifying Exchange Rate Regimes: Deeds vs. Words. Business School, Universidad Torcuato Di Tella. Dostupno na: [http://papers.ssrn.com/sol3/papers.cfm?abstract\\_id=214428](http://papers.ssrn.com/sol3/papers.cfm?abstract_id=214428) (Prístup 05.10.2012.)
- IMF. (2009), Annual Report on Exchange Rate Arrangements and Exchange Restrictions. Dostupno na: <http://www.imf.org/external/np/mfd/er/index.asp>. (pristup 10.10.2012.)
- MMF. (2011), World Economic Outlook Database. Dostupno na: <http://www.imf.org/external/pubs/ft/weo/2011/01/> (pristup 11.10.2012.)
- Visser, H., (2002), A Guide to International Monetary Economics. USA: Edward Elgar

# INDUSTRIAL POLICY IN TRANSITION – OBSOLETE IDEA OR THE NEED IN POST-CRISIS CONDITIONS

Vladimir Mičić<sup>1</sup>

**Abstract:** *All Central and Eastern European countries as well as our, have experienced numerous both positive and negative experiences of industry restructuring in transition process. Serbia today represents the country in which reindustrialization process advanced the least. Such situation is very unfavorable and deteriorated with global economic crisis. The topic of this paper should demonstrate that our country has to conduct reindustrialization process seriously, as well as to implement adequate strategy of industrial development. In Serbia, industrial progress means also economic progress in the following period, so that adequate industrial policy should occupy a key place, as the incentive and method for development. The aim of the paper is to see the need for an active and efficient industrial policy that should represent one of fundamental ways to keep up with advanced transitional countries and involvement into international markets, especially in the economic crisis condition.*

**Keywords:** *industrial policy, reindustrialization, transition countries, economic crisis.*

## Introduction

Contemporary industrial policy is based upon theory and models of endogenous development. It is related to the process of institutional engineering and shaping the nature of economic actors, market mechanisms and the rules of their functioning, as well as establishing the boundary between those that are regulated by market interactions and that are not (Cimoli, M., et al. 2009). Motives for interventions do not come solely from market deficiency, different externalities, market power and economy of scale, but also due to deficiencies of financial and capital market, incentives for investments into research and development and application of innovations, strategic competitiveness, assistance for developing industries and industries of future, support to dying industries, protection of intellectual property rights (Begg, et al. 2010). It also consists of policies that affect exchange, development of science and technologies, public procurements, domestic and foreign investors.

The real question regarding industrial policy is not if it should be applied, but now? Industrial policy became one of fundamental choices for efficient industrial (Rodrik, 2010), as well as overall economic development, especially in world economic crisis conditions. Industrial policy, in broader sense, is a constant phenomenon in all successfully conducted industrializations. There are numerous examples of countries that owe their development to active industrial policy. The confirmation of this are certainly experiences of successful industrializations, starting from Germany and USA, almost two centuries ago, up to South Korea, Taiwan, Brazil, China and idea today (Rodrik, 2010, Cimoli, M., et al. 2009).

Behind us is the period in which industrial policy for both developed and developing countries was an „ugly word“, and market fundamentalism of Washington consensus dominated in theory and practice (Cimoli, M., et al. 2009). Supporters of neoliberal Washington consensus regarded industrial policy as unnecessary, but in reality, successful economies always leaned upon policies that promote development and accelerate structural changes. USA used industrial policy when there was an

---

<sup>1</sup> Faculty of Economics, University of Kragujevac, micicv@kg.ac.rs

## **INDUSTRIAL POLICY IN TRANSITION – OBSOLETE IDEA OR THE NEED IN POST-CRISIS CONDITIONS**

---

economic and historical interest for it, although in USA it is not called industrial policy (Savić, et al. 2011). Strong technical progress in USA is the result of direct support of the state (development of Silicon Valley and Internet, as well as saving of car industry in 2009.). The shift in direction of definitive acceptance of industrial policy is welcomed recognition of the thing that more reasonable analysts of economic growth know for a long time, is that development, and especially of new industries frequently demands strong, sophisticated or direct, support of the state (Rodrik, 2010).

An example of flexible, sophisticated and active industrial policy is the one applied on the level of EU. With Lebanon strategy in 2000, it is clearly defined that reindustrialization of EU creates positive external effects on the whole economy and accelerates its growth (European Council, internet site, accessed on, 10 May 2012). World economic crisis and its effects on industry accentuated the need for „industrial policy for the period and conditions of globalization“, which was defined within strategy „Europe 2020“ (European Commission, internet site, accessed on, 10 May 2012).

Restructuring and modernization of industry became a part of overall transitional transformation of Serbian economy. Analysis in this paper should demonstrate that Serbia should approach reindustrialization seriously and efficiently in process of transition. In Serbia in the following period, industrial progress stands also for economic progress, so that adequate industrial policy should have the key place, as the incentive and method for development of the industry. The aim of this work is to see the need for an active and efficient (post) –crisis industrial policy, which should represent one of fundamental ways for keeping up with development of transition countries.

### **The effects of transition of Serbian economy in the first decade of XXI century**

All European former socialist countries, as well as Serbia, are from the beginning of 1990s in process of transition, which exhibited numerous positive and negative sides. Although Serbia in the period of 1980s was the forefront in giving the suitable role to the market, Serbia with significant delay, but very ambitious, entered transition process starting from 2001. Transition problems that faced it were serious and numerous. The advantage of delay was useful positive and negative experiences of transition process, in order not to repeat errors performed by other countries in transition during 1990s.

When we look the other phase of transition from 2001. and analyze the dynamics of conducting the transition changes, it can be observed that Serbia achieved progress according to all yearly indicators of EBRD in the area of conducting the transition changes. Average value of yearly EBRD indicators increased from 1.85 in 2001, to 2.93 in 2010 (Table 1).

After significant progress, ambitious and very radical reforms in Serbia were after 2003. seriously slowed down. Difficulties were inevitable, even without these tragically events, because construction of market economy, before or after, is inevitably faced with occasional recessions and crisis (Cerović, 2009). Comparative analysis clearly shows that Serbia today represents the country where transition process towards market economy is the least advanced, and achieved results are very modest and far from expected ones. The fact that current transition process and necessary transition reforms were not efficient, make the socio-economic situation very unfavorable, especially due to the effects of world economic crisis.

**Table 1. The average score – Transition indicators for Serbia, 2001-2010.**

<i>By country</i>	2001	2002	2003	2004	2005	2006	2007	2008	2009	2010	2010/01
Hungary	3.85	3.85	3.85	3.89	3.96	3.96	3.96	3.96	3.96	3.93	3.92
Poland	3.66	3.66	3.66	3.66	3.78	3.81	3.81	3.81	3.81	3.89	3.76
Slovakia	3.41	3.52	3.59	3.67	3.70	3.74	3.74	3.74	3.78	3.74	3.66
Croatia	3.22	3.30	3.37	3.44	3.44	3.48	3.52	3.52	3.55	3.55	3.44
Bulgaria	3.18	3.26	3.30	3.37	3.41	3.48	3.48	3.56	3.56	3.56	3.41
Slovenia	3.33	3.37	3.37	3.37	3.37	3.37	3.37	3.41	3.41	3.41	3.38
Romania	3.07	3.07	3.11	3.22	3.26	3.33	3.41	3.44	3.44	3.48	3.28
FYR Macedonia	2.85	2.85	2.89	3.04	3.04	3.11	3.15	3.18	3.26	3.26	3.06
Albania	2.81	2.81	2.81	2.89	2.89	2.93	2.96	3.04	3.07	3.07	2.93
Bosnia and Hercegovina	2.22	2.37	2.48	2.52	2.56	2.63	2.70	2.78	2.78	2.82	2.59
Serbia	1.85	2.33	2.41	2.44	2.59	2.70	2.74	2.85	2.89	2.93	2.57
Montenegro	1.82	2.26	2.33	2.41	2.63	2.67	2.78	2.82	2.85	2.89	2.55

Source: Forecasts, macro data, transition indicators, 2012. EBRD, (10 May 2012), <http://www.ebrd.com/country/sector/econo/stats/index.htm>.

Looking per key areas important for transition process achieved results was very different. The best results were made in the area of deregulation, liberalization and partly privatization of small enterprises. It is obvious that privatization of large companies, process of restructuring of companies, reform of infrastructural sector, and especially of institutional character, that is improvement of competition and development of capital market and non banking financial institution, were not completed, were conducted partially and unevenly, and in some parts are in initial stage (Table 2).

**Table 2. Transitional indicators by sectors, 2001-2010.**

<i>By sector</i>	2001	2002	2003	2004	2005	2006	2007	2008	2009	2010
Large scale privatisation	1.00	2.00	2.33	2.33	2.67	2.67	2.67	2.67	2.67	2.67
Small scale privatisation	3.00	3.00	3.00	3.33	3.33	3.67	3.67	3.67	3.67	3.67
Governance and enterprise restructuring	1.00	2.00	2.00	2.00	2.33	2.33	2.33	2.33	2.33	2.33
Price liberalisation	4.00	4.00	4.00	4.00	4.00	4.00	4.00	4.00	4.00	4.00
Trade and foreign exchange system	2.67	3.00	3.00	3.00	3.33	3.33	3.33	3.67	4.00	4.00
Competition Policy	1.00	1.00	1.00	1.00	1.00	1.67	2.00	2.00	2.00	2.33
Banking reform & interest rate liberalisation	1.00	2.33	2.33	2.33	2.67	2.67	2.67	3.00	3.00	3.00
Securities markets & non-bank financial institutions	1.00	1.67	2.00	2.00	2.00	2.00	2.00	2.00	2.00	2.00
Overall infrastructure reform	2.00	2.00	2.00	2.00	2.00	2.00	2.00	2.33	2.33	2.33

Source: Forecasts, macro data, transition indicators, 2012. EBRD, (10 May 2012), <http://www.ebrd.com/country/sector/econo/stats/index.htm>.

Causes of reform inefficiencies are numerous. Effects of privatization are not favorable unless there is no parallel provision of competitive structure and formed adequate institutional system. Namely, private ownership itself does not provide for high efficiency if the market itself is not competitive, that is, simultaneously both processes should be conducted. Besides, privatization cannot be neither efficient nor transparent if it is conducted in unregulated institutional surrounding. Efficiency of undertaken reforms would be significantly higher if the timeline of reform undertaken and their coherence were better incorporated (Cerović, 2009). With the rise of problems, system where government has the key role started developing. If it referred to the creation of favorable business climate, with predictable and certain rules of performance, in advance, the effects of transition would be much better, and corresponding transitional indicators much higher (Savić, 2010).

Unfortunately, many expectations that transition reforms would enable radical upgrading of key economic performances remained largely unrealized. In addition, since 2008, world economic crisis affects strongly economy of Serbia. It is important that in conditions of world economic crisis and orientation towards solution of current issues, the country does not lose its reform pace, because full market transformation of the economy is important for achieving the quality and long term sustainable growth and development.

### **Transition and industry**

The achieved level of industrialization at the beginning of 1990s on Central and Eastern European countries is the result of many years of application of socialist model of „rapid“ industrialization. At the same time, industrial policy was the basis of economic policy, that is included economic policy with prevalent effects on the industry and was significantly different from industrial policies of developed countries. Consequences were inevitable because some typical sectoral problems were solved by inappropriate instruments of economic policy (Savić, 2007).

Staggering of applied model of industrialization of former centrally planned countries lasted for a long time, and crash and the collapse occurred rather rapidly at the end of 1980s. Problems facing the industry in post socialist countries in early stage of transition are mostly the result of development in previous period. Inadequate industrial structure demanded much needed structural changes.

In the development of Serbia after Second World War industry played the key role. Its serious staggering started in 1980s. During 1990s Serbian model of industrialization, partly different from socialist due to orientation towards light industry branches and favoring spending over saving, suffered a breakdown. Within this model for a long time was applied import-substitutive strategy of industrialization, with tendencies of extensive development and autarchy. This strategy until 1965 was giving positive economic effects. After that, despite certain reforms, there was there was no proper defined and conducted strategy for industrial development, nor industrial policy. Industrial policy had sectoral character, was considered a part of economic and development policy.

Structural changes and restructuring of industry in transition countries became a part of overall process of economic transformation. Due to industrial collapse, almost all countries in transition except for Poland in early 1990s had fall in industrial production, while in the second half of 1990s, except for Bulgaria and Romania, they have achieved the growth of industrial production, due to investment, consumption and export growth (Table 3).

In the period 1996-2000 there have been significant changes in structure of industrial production which reflected in recovery and further growth of industries of Central and Eastern European countries. The biggest fall in participation had labor-intensive industries. Above the average growth of participation had industries based upon usage of modern technologies and economy of scale (RZR, 2009). Already in the initial stage of transition it became clear that structural changes and industry restructuring were essential activities and that privatization process and liberalization of



prices and foreign trade were not sufficient in order to provide sustainable economic growth and progress of industries in transition. This very painful process required satisfactory macro economic conditions, suitable institutions and adequate national industrial policies, as necessary prerequisite of structural changes and achieving of competitiveness of industries of developed economies, based upon innovations in technical area.

**Table 3. Average growth rates of industrial production, 1991-2000.**

	1991-1995	1996-2000	1991-2000
Bulgaria	-6.6	-4.7	-5.7
Czech Republic	-4.7	1.4	-1.7
Estonia	-1.0	8.8	6.0
Latvia	-14.5	4.8	-4.9
Lithuania	-22.1	2.1	-10.0
Hungary	-2.0	9.6	3.8
Poland	4.7	6.0	5.4
Romania	-6.1	-3.3	-4.7
Slovenia	-5.6	2.7	-1.5
Slovakia	-4.4	2.8	-0.8
Croatia	0.0	5.9	5.9
Serbia	-16.7	1.6	-7.5

Source: *Forecasts, macro data, transition indicators, 2012. EBRD, (10 May 2012),* <<http://www.ebrd.com/country/sector/econo/stats/index.htm>>, and *Industry production index, 2012. Eurostat, (10 May 2012),* <<http://appsso.eurostat.ec.europa.eu/nui/show.do?dataset>>

In the period between 1990. and 2000. Serbia did not create needed and essential reforms. Events during 1990s, due to great political, economic and social changes, led to general breakdown of industry, which affected drastic decline in overall industrial production and capacity utilisation (around 30%), and export was almost stopped. We could estimate that problems of industrial development were caused by numerous factors, and more important are certainly related to fully lack of strategy for industrial development and industrial policy, i. e. Inefficiency of structural reforms, technological backwardness and non implementation of modernization.

Dynamic growth of industrial production and activities in transition countries of Central and Eastern Europe continued also in the period between 2000-2007 (Table 4).

Performed market and institutional reforms, inflow of foreign investments, dislocation of industrial capacities from highly developed industrial countries of EU, structural changes and specialization of production and coherence between export and needs of foreign import demand, favorable conjuncture movements on world market before global economic crisis, membership in EU and access to EU market, influenced that most countries in transition that are new members of EU increase their export, which reflected, except for increase of industrial production on employment growth. In most of transition countries, industry has great importance in development, so its participation maintained on the high level in creation of gross value added (GVA) and employment, and therefore industry became an important factor that affects growth GDP of these countries (table 5). We could estimate that the growth of industrial sector in pre-crisis period in these countries shows improvement of their efficiency and growth of the level of international competitiveness thanks to conducting of reindustrialization process.

## INDUSTRIAL POLICY IN TRANSITION – OBSOLETE IDEA OR THE NEED IN POST-CRISIS CONDITIONS

**Table 4. Industrial production growth rates, 2001-2011.**

	2001-2007 <sup>1)</sup>	2008	2009	2010	2011	2001-2011 <sup>1)</sup>
Bulgaria	7.9	0.1	-18.0	2.0	5.8	4.1
Czech Republic	6.6	-2.4	-13.1	9.8	6.4	4.3
Estonia	9.4	-4.8	-23.9	23.0	16.5	7.0
Latvia	6.8	-3.2	-17.7	14.5	8.8	4.5
Lithuania	8.5	5.2	-14.3	6.4	7.6	5.9
Hungary	6.6	-0.9	-17.4	10.3	5.4	4.0
Poland	7.0	2.4	-3.7	10.8	7.2	6.0
Romania	3.2	2.8	-6.2	5.5	6.0	2.8
Slovenia	4.1	1.6	-17.6	6.0	1.8	1.9
Slovakia	8.8	2.9	-14.1	18.3	7.1	6.9
Croatia	4.5	0.6	-8.9	-1.5	-1.2	1.9
Serbia	2.2	1.1	-12.6	2.5	1.9	0.7

Source: Forecasts, macro data, transition indicators, 2012. EBRD, (10 May 2012), <<http://www.ebrd.com/country/sector/econo/stats/index.htm>>, and Industry production index, 2012. Eurostat, (10 May 2012), <<http://appsso.eurostat.ec.europa.eu/nui/show.do?dataset>>

<sup>1)</sup> Average growth rates

**Table 5. Tendency of industry participation in total economy, 2001-2010.**

	GVA in %				Employment %			
	2001	2005	2010	2001-10 <sup>1)</sup>	2001	2005	2010	2001-10 <sup>1)</sup>
EU - 27	21.8	20.2	18.7	20.1	-	-	-	-
Bulgaria	22.2	23.2	23.1	23.0	23.1	22.2	20.1	22.0
Czech Republic	30.1	30.1	29.5	29.8	31.6	30.1	28.2	30.0
Estonia	22.5	21.5	23.0	21.5	26.2	26.0	22.7	24.5
Latvia	17.7	15.6	16.8	15.8	19.0	18.1	16.3	17.5
Lithuania	24.6	25.2	22.2	23.4	20.8	20.1	17.7	19.7
Hungary	25.9	25.2	27.0	25.5	26.3	24.2	22.6	24.5
Poland	22.5	24.7	24.5	24.1	23.8	23.3	22.1	23.2
Romania	29.4	28.1	28.7	28.0	20.8	24.4	23.3	23.9
Slovenia	29.1	27.4	24.7	27.0	29.8	27.5	22.6	26.6
Slovakia	28.5	29.7	26.0	28.7	28.1	26.7	23.6	26.4
Croatia	22.8	21.0	19.0	20.6	23.5	20.5	-	21.9
Serbia	24.8	21.5	21.3	22.0	33.5	21.5	19.3	21.9

Source: National Accounts aggregates and employment by branch, 2012. Eurostat, (10 May 2012), <<http://appsso.eurostat.ec.europa.eu/nui/show.do?dataset>>, and UNECE Statistical Database, 2012, UNECE, (10 May 2012), <<http://w3.unece.org>>

1) Average participation

Unlike observed countries in transition, industry in Serbia faces totally different tendencies that leave mark on the fall in production and low export. Key problem of low export is uncompetitiveness, insufficient and inadequate structural changes and restructuring of industry, that is its modernization. It is indisputable that global crisis significantly influenced on recession in Serbian industry since 2008, but average growth rates from only 2,2% between 2001. and 2007. and permanent tendency of decreasing participation in formation of total GVA and participation in employment between 2001. and 2010. Demonstrate that Serbian industry is in a very deep crisis, even without effects of world economic crisis.

It is clear that also in the period between 2001. and 2010. Was not precisely defined and adequately performed industrial policy, which is based on orientation towards production, concept of development and is in the function of realization of strategy for industrial development. The thing which is mostly included into industrial policy of Serbia can be observed as combination of efforts for privatization and restructuring of companies, foreign investments attraction, creation of favorable business climate together with measures for development of small and medium enterprises and entrepreneurship, selective incentives of export through subsidy and activities of balanced regional development.

Regarding long term transition crisis, we could seriously ask the question, wheather some problems of contemporary industrial development are just the result of transition crisis. The answer is undoubtedly yes. Key cause of crisis is in serious problems related to transition process and applied model of economic development based upon dynamic tertiarization, deindustrialization and inadequate industrial policy, that is inadequate concept of economic and transition reforms performed since 2001. Indicators and index of the status of Serbian industry support thesis that it is for a long time (permanently) in deep crisis and that roots of crisis in our industry have little connection with roots of world crisis. It led to the fact that long term problems in industry become more expressed and visible. Serbia did not use relatively favourable international economic environment and conjunctural movements in the period before global crisis, to improve its institutional, development and general economic performances and to perform necessary structural reforms in industry, which will help it to ready welcomes the crisis and does not experience such drastic fall of industrial production. Unlike Serbia, more advanced transition countries thanks to reindustrialization process conducted in pre-crisis period consolidated successfully their industrial production in 2010. and 2011. although most of them had two figures fall in industrial production in the wake of the first wave of global recession.

At the end, some alternative routes that could be more successful in transition, were not accepted, due to unconditional and uncritical acceptance of economic liberalization. Observations, estimations and adjustments, due to all of it, must be integral parts of transitional phases implementation, in order to observe and correct omissions made in the heat of the initial enthusiasm. Because of all the measures that have proven to be poor in countries that started transition sooner, became rather clear that instead of advocating for full liberalization, it is necessary thorough, deeper, more considered industrial policy in order to minimize unfavourable effects of economic transition (Savić, 2007).

### **The role of industrial policy in development of countries in transition (Serbia as well) in post crisis period**

One of the possible approaches to transition process is related to the place and role of industrial policy in order to affect efficiency of industrial and economic development. It is proven that market spontaneously and by itself does not lead to progress in countries in transition, resulting in the necessity of state intervention, in order to eliminate big deficiencies and imperfections of market mechanisms. Economy in transition affected by world economic crisis could not exist without active role of state, which provides wide frameworks for coordination and implementation of long term

## **INDUSTRIAL POLICY IN TRANSITION – OBSOLETE IDEA OR THE NEED IN POST-CRISIS CONDITIONS**

---

development strategies. Economic crisis affected the most serious industries in countries in transition. Recession demonstrated clearly the essence of the problem in the model of economic development which neglects industrial sector and marked changes in economic policy, taking counter-cyclical measures, increase of state intervention and again affirmed importance of adopting and implementing adequate industrial policy.

When we speak about development of our industry in post crisis period, we should have in mind also expectations that like until now, industry will further be main pillar of development and of vital importance for economy of Central and Eastern European countries, and its impact over development will stretch far beyond the core business of production. Although some sectors went through significant changes, in sectors where restructuring was not fast enough or radical enough, some painful reforms would still be needed. It will achieve specialization mostly in medium-high technologies, while stagnation and lagging behind will have traditional labor-intensive branches. On the other side, old members of EU will leave and relocate production of some goods and gradually specialize for production activities with high added value (European Commission, 2009).

In such conditions industrial policy should have key place, to be long term oriented, as the incentive and method of development. Correctly and precisely defined and adequately operated industrial policy shapes, as well as accelerates paths of growth and sustainable development, which could avoid many economic problems of Serbia if there was right and proper role of industrial policy. It is one of fundamental choices for economic growth in general and is the key for advancement of some today medium developed and developed countries. Managing modern economy and channeling processes of change in economic structures without some form of industrial policy is not possible (Savić, 2007).

Active industrial policy in transition countries can lead to convergence towards development of the most developed countries in EU. Convergence demands efficient industrial development, existence of suitable institutional, infrastructural and macroeconomic frame. Efficient industrial development in transition countries demands managing structural changes, process of reindustrialization, higher level of productivity and improvement of international competitiveness of national industries through improvement of and application of knowledge and technology innovations, which will induce expansion of export across national boundaries, achieved higher growth rates and high employment rates. Therefore countries in transition would accept wider understanding of industrial policy as the mean to achieve economic progress, provide growth of standard of living and increase quality of life, especially in post-crisis period. Without active industrial policy is not possible, beyond other things, to achieve social cohesion, larger use of alternative sources of energy and protection of environment.

Goals of (post) crisis industrial policy in transition countries must be derived from basic socio-economic concept of development. It influences that it must cover wider interests of numerous interested parties and groups, conscious and sophisticated actions of society, which practically means that it must be regarded as more complex and wider than simple and direct state intervention focused only on industry. Industrial policy setup like this is used to define broader frame of macro and micro-economic strategic state activities and actions on the supply side and demand side, through a series of management mechanisms in the elimination the causes of the crisis, improvement of market operations and regulating overall economic environment and industrial framework conditions.

New industrial policy in Serbia should be focused in post-crisis period on modernization and restructuring of industries, innovation development, usage of new technologies, development of new products with high value added, improvement of business environment, especially for small and medium enterprises and entrepreneurship, sustainable development and employment, environmental efficiency and creation of knowledge-based economy, that is human capital as the key factor. In defining new, active and sophisticated industrial policy authorized institutions should cooperate with all stakeholders (employers, labor unions, universities, NGOs, consumers organizations), in order to create framework for modern industrial policy, which will provide support and assist industry to meet

new challenges. In its conceptions should be used all available and disposable worldwide experiences. Initiating overall industrial development should be performed selectively, with the use of familiar tools of industrial policy. Its implementation, except for industrial, should cover development of some other activities, which will inevitably impact over its total efficiency.

In order for the industrial policy to be successful, it should respect some principles and rules (Rodrik, 2004). It should represent a complete system of components, consisted of goals, measures, resources and bearers or bodies (agencies) which create and implement suitable measures. Also, in industrial policy should be established clear indicators and criteria of success, duration and length of application of certain measures. Thus, an adequate approach to industrial policy gives an essential role to progress and prosperity. That approach is in accordance with the best practice and experiences, approach which is focused on goals that should be pursued, changes that should be achieved, measures and methods for achieving desired results, process of monitoring progress and problems, as well as alignment and adjustment of activities in relation to the existing problems or new approaches in certain period.

### **Conclusion**

It can be assessed that despite achieved progress in implementation of transition reforms in Serbia since 2001, many of desired and expected goals and results were not realized. Process of transition in Serbia was not efficient and was not of satisfactory pace. Some reforms, mostly short-term, were conducted well, and with some, long term and structural was achieved very modest progress. Therefore, since 2008. World economic crisis strongly affects economy of Serbia, focusing attention on current problems solving, which additionally slowed reform process, market transformation of the economy, development of institutions, privatization, restructuring and modernization, as important factors for achieving quality and long term sustainable growth and development. At the same time, no matter of numerous and very different problems facing countries in Central and East Europe, most of them rather successfully implements and conquer transition reforms which are still ongoing.

As an integral and very important part of transition process, structural changes and restructuring of industries in Central and Eastern European countries, by their character, coverage and depth, are very serious, complex, timely, demanding and very important process. All successful countries in transition, that became members of EU, had very dynamic industrial growth in the period 2001-2007, thanks to conducted process of modernization and reindustrialization in the conditions of favorable conjuncture movements in the period before, but also during global economic crisis. Unlike successful countries in transition development of industry in Serbia was totally neglected, and in the second phase of transition since 2001. it has continued to fall deeper and deeper. In this period economy of Serbia goes through deindustrialization and dynamic tertiarization, although industry had key place in overall economic development in longer period of time. At the same time there was no a properly defined and implemented industrial policy.

One of the possible approaches to transition process is related to adequate place and role of industrial policy in order to affect on efficiency of economic development of Serbia. Industrial policy should not be considered as „necessary evil“ but the way to solve long term and difficult problems facing devastated Serbian industry. It is certain that new concept of reindustrialization must be followed by active industrial policy. It should be treated in wider context due to the facts that it covers different measures, activities, influences and mechanisms of support in transition and period of post crisis development.

**References:**

- Begg, D., Fischer, S., and Dornbusch, R., (2010). *Ekonomija*, Data Status, Beograd.
- Cerović, B. (2009). Srbija u tranziciji i krizi, *Tranzicija u Srbiji i globalna ekonomska kriza*, NDE, AEN i Ekonomski fakultet, Beograd, str. 11-30.
- Cimoli, M., Dosi, G., and Stiglitz, E. J., (2009). *The Political Economy of Capabilities Accumulation: The Past and Future of Policies for Industrial Development*, Industrial Policy and Development - The Political Economy of Capabilities Accumulation, Oxford University Press, New York, pp. 1-2.
- Employment, economic reform and social cohesion*, (2000). European Council, (10 May 2012), <[http://www.europarl.europa.eu/ftu/pdf/en/FTU\\_4.1.pdf](http://www.europarl.europa.eu/ftu/pdf/en/FTU_4.1.pdf)>.
- Europe 2020 - A European strategy for smart, sustainable and inclusive growth*, (2010). European Commission (10 May 2012), <<http://ec.europa.eu/eu2020/pdf>>.
- European Commission, (2009). *EU industrial structure 2009 — Performance and competitiveness*, Publications Office of the European Union, Luxembourg, pp, 174-180.
- Forecasts, macro data, transition indicators*, 2012. EBRD, (10 May 2012), <<http://www.ebrd.com/country/sector/econo/stats/index.htm>>.
- Republički zavod za razvoj, (2009). *Industrija Srbije 2008.*, Beograd.
- Rodrik, D., (2004). *Industrial Policy for the Twenty First Century*, Harvard University, Cambridge, <http://www.hks.harvard.edu/fs/drodrik/UNIDOSep.pdf>. (20.09.2009.).
- Rodrik, D., (2010). *The Return of Industrial Policy*, Project Syndicate, <http://www.project-syndicate.org/commentary/rodrik42/English> (20.09.2010.).
- Savić, Lj., (2007). *Ekonomika industrije*, CID, Ekonomski fakultet Beograd, Beograd.
- Savić, Lj., (2010). *Reindustrijalizacija kao osnova novog modela razvoja*, Ekonomsko-socijalna struktura Srbije – Učinak prve decenije tranzicije, NDE, AEN i Ekonomski fakultet, Beograd, str. 187-206.
- Savić, Lj., i Mičić, V., (2011). *World economic crisis - Messages for the Future*, International scientific Conference, Contemporary Issues in Economics, Business and Management, EBM 2010 Conference, December 14-15, 2010, Faculty of Economics – University of Kragujevac, Kragujevac, Serbia.

# ALTERNATIVE APPROACHES TO RISK MANAGEMENT IN INSURANCE COMPANIES

Milena Jakšić<sup>1</sup>

Violeta Todorović<sup>2</sup>

Milka Grbić<sup>3</sup>

**Abstract:** *The economic efficiency of the operations of insurance companies depends on successful management of financial flows, as well as minimize business risk. Timely response to changing economic conditions and continued to identify and control internal and external risks to adequate planning of future activities of insurance companies. When taking risks they must take care of their financial capabilities and the risks that go beyond their financial capacity (retention) adequately cover the contracts of coinsurance and reinsurance. However, increasing the number and intensity of adverse events requires a comprehensive risk management, which includes both of coinsurance and reinsurance of multi and use of alternative risk transfer mechanisms to the capital market. Application of alternative risk transfer instruments enhances the solvency of insurance companies, which ultimately contributes to greater safety insured. Starting from the limited capacity of coinsurance and reinsurance sector work aimed to conduct a comprehensive analysis of risk management in insurance, which will indicate the future solutions for the proper management of risks in insurance industry in Serbia. The result of applied research will be an understanding of individual situations or cases investigated, by comparing selected relevant indicators to be studied.*

**Keywords:** *insurance, coinsurance, reinsurance, risk management, transfer of risk*

## Introduction

The economic reality of the modern market economies confirms the emergence of the new risks as well as the modification of existing risks that by its intensity can endanger property and individuals. Therefore, considering the risk that is loaded each concrete investment must not be neglected or left to the institution. Incorrect risk assessment may result as a lack of expected yield or even the loss of the investment capital.

Insurance companies traditionally manage the risks through a risk retention and transfer of risks beyond its capacity to reinsurers. However, the total available capacities of insurance sector and reinsurance are limited. By this, in terms of continuous increase in number and an intensity of adverse events, leads to the development of financial instruments that enable the risk management through the capital markets.

Considering what was stated, case study will be directed to researching the alternative approaches to risk management in insurance companies. The aim of this research is to perform the comprehensive analysis of risk management in insurance companies of developed economies and to use these experiences for controlling the risk management in insurance and reinsurance companies that operate in the territory of the Republic of Serbia. The crucial hypothesis from which the business begin is: If the complete integration of the insurance market achieves, reinsurance and capital markets, then alternative models of risk transfer provide sufficient funds to cover the risk.

---

<sup>1</sup> Faculty of Economics, University of Kragujevac, milenaj@kg.ac.rs

<sup>2</sup> Faculty of Economics, University of Kragujevac

<sup>3</sup> Faculty of Economics, University of Kragujevac

Taking into account about determined case, the aim and hypothesis in the process first will be presented the crucial hypothesis of the risk. Then different approaches to risk management in insurance companies will be analyzed. Since in the focus analysis will be traditional and alternative approaches to risk management, separately will be discussed: reinsurance and risk transfer instruments to the capital markets. Finally, the possible directions for further development approaches to risk management in insurance companies will be presented which operate in the territory of the Republic of Serbia.

### **The concept of risk in financial management**

In the last three decades under the conditions of globalization, deregulation and information technology comes to the growth of association and interdependence of financial flows. The association and interdependence are the assumptions of positive and negative synergy (Đuričin, 2009b). Theoretical arguments in favor of interdependence are based on the fundamental theorems of welfare economy (market competition provides a Pareto optimum) and also the theories and the efficiency of financial market (all information on the financial market, immediately and entirely, incorporate into the decisions of market participants) (Eatwell, 1996). On the other hand, moral hazard is a negative phenomenon that can be easily converted into turbulence that is difficult to predict. The economy of the moral hazard creates imbalance between the generated values in the real sector and represented values in financial sector. Stated imbalance forms speculative bubble that when it bursts the moral hazard economy cease to exist, but burst of the speculative bubble causes the crises which evokes the cascading effect which is producing at the level of the global economy.

In the global environment the risk becomes inseparable component of the economic activities of participants in the real and financial sector. The risk is associated with the uncertainty of realizing the future outcomes. In broader term, the risk presents the possibility that some unexpected event occur which may have the consequences on the set up goals. At that, the consequences can be both positive and negative. However, the risk, in the narrow sense, presents a chance for the most wanted event to occur. This is a situation in which there is a possibility of the negative deviation from the desired outcome, in other words the realization of the risk will negatively affect on the achievement of defined goals.

The possibility of actual deviations from the desired outcome is a key entry in defining a risk. One of the first attempts to understand the trade-off between risk and expected return belongs to Markowitz (1952). The investors tend to achieve high yields on their investments, however most investors have an aversion to the risk. The risks reduce the marginal utility of wealth, because the utility function is concave in comparison to the wealth (Figure 1). Additional or marginal increment in wealth increases the benefit for successively smaller amount, so that investors with a concave utility function possess a reduced marginal utility of wealth (Elton, 2005). For any level of wealth, the given wealth decline leads to a larger fall of utility than the same increase of wealth lead to a greater usefulness.

As can be seen, the level of utility or satisfaction increases less and less as the wealth increases. The initial level of wealth  $w_0$  implies the utility level from  $u(w_0)$ . If the wealth decreases by the amount  $\Delta w_1 = w_0 - w_1$ , the utility decreases by the amount  $\Delta u_1 = u(w_0) - u(w_1)$ . On the other hand, if wealth increases for the same amount  $\Delta w_2 = w_2 - w_0$ , utility increases by the amount of  $\Delta u_2 = u(w_2) - u(w_0)$ . When the marginal utility is reduced,  $\Delta u_1$  is always greater than  $\Delta u_2$ . The investors who have aversion towards the risk will never choose a risky investment that offers the same expected return as well as an institution which is free from the risk. Investors who are neutral to risk have a linear utility function that displays constant marginal utility of wealth and therefore will be indifferent between the choice of risk-free and risky investment, that offer the same expected return. For such investors  $\Delta u_1 = \Delta u_2$ .



Finally, investors who accept the risk have a convex utility function that displays increasing marginal utility of wealth. Therefore they will prefer risky investments, because in this case  $\Delta u_2 > \Delta u_1$ .

**Figure 1. Concave utility functions**

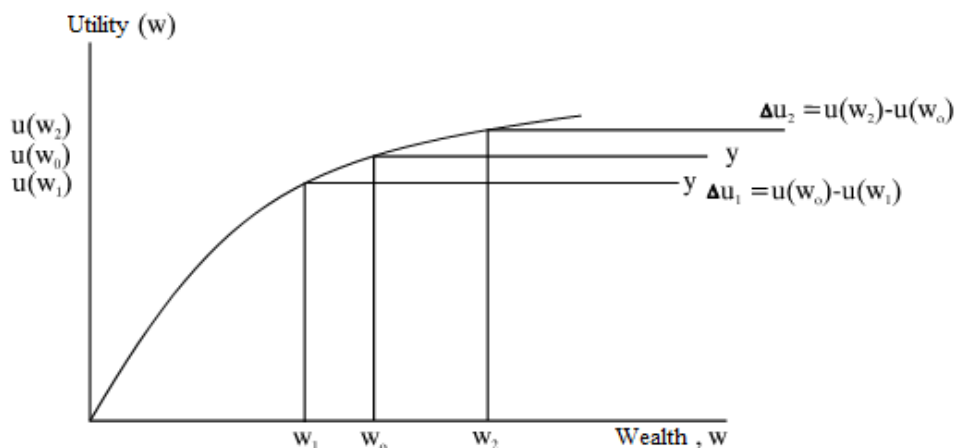

Source: Elton, E. J. (2005). *Modern Portfolio Theory*, Journal of Finance, April, No.7-8, p. 10.

Taking into account the stated, it should be noted that in the last three decades, due to the liberalization of financial flows, the risk was underestimated and/or transmitted to others. This caused the change of strategy towards the risk in terms of that the investors strategies of highly averted to the risk evolved into strategies that are defined by the high risk propensity. It is obvious that in conditions of the global financial crisis and recession the attitude to the risk has to be changed. Avoiding the risk under the conditions of low level of economic activity is not desirable. What is necessary to manage the risk, but in an intelligent manner which contributes to the value creation (Đuričin, 2009b).

### The importance of risk management

Although risk taking has always been closely related with the basic activities of financial institutions, until the late eighties of the XX century, they did not have an independent risk management function nor was the concept of risk widely known. In practice traditional concepts of risk measurement based on the fundamental analysis were dominating. Understanding the indisputable importance of risk management begins when the financial institutions have accepted the internal methods based on complementary measures of risk.

Risk management makes an integral part of management activities in all sectors. It is about a concept that implies a set of coordinated activities on management and controlling the organization in terms of risk. In the changed operating conditions it is obvious that a new model of risk management is needed that is based on identifying all potential risks, their assessment and measurement, noticing the consequences on the basis of taking an adequate strategies, such as prevention and reduction, avoidance or retention and transfer, in other words risk transfer.

This seemingly simple serie of presented activities indicates that a continual process of risk management is in question. However, the risk management process should not be viewed merely as a process of defense against the risk, because financial institutions choose the type and the level of risk that is acceptable for their undertaking. Most business decisions involve the sacrifice of current yield

for the sake of uncertain future returns. Risk management and risk-taking are not mutually contradictory activities, but they represent two sides of the same process. Exactly the extended concept of risk management is not based only on risk avoidance, but also on the use of risk (Sigal, 2008). Under the conditions of economic activities at the low level of the economic activity it is necessary to manage the risks in the way that will contribute of forming validity, in other words to select a strategy that brings the highest value for the acceptable risk level.

**Figure 2. The risk management process**

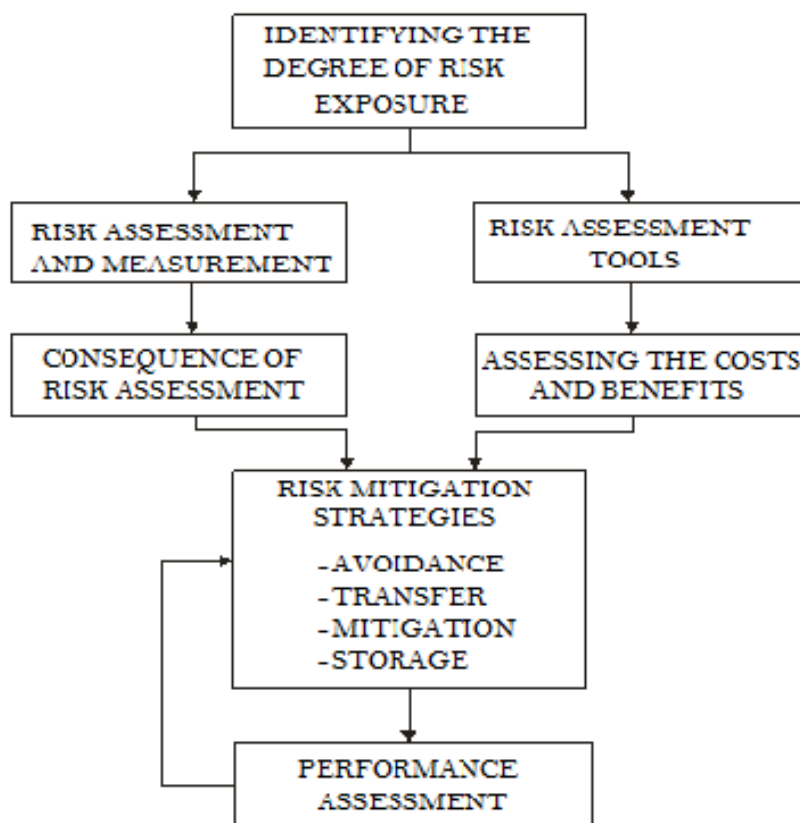

*Source: Crouhy, M., Robert N. (2006). The Essentials of Risk Management, McGraw-Hill, New York, p.2.*

Sometimes it seems that a simple process of identifying the risk is complex one, because it is difficult to draw a clear line where the risk ends, and the other begins. In addition it is also very complex methodology for quantifying the risk. Measures to quantify the risks are numerous and depend on the type of risks which want to be measured. Thus, for example to quantify the risks the most commonly used is the variance and standard deviation, net assessment of the present value, internal rate of return, the capital asset pricing model (CAMP), as well as measuring value at risk (VAR – value at risk). In recent years the measured value at risk (VaR), together with its sub-variants, such as TVaR (Tail Value at Risk) and XTvaR (Excess Tail Value at Risk), are given the most attention (Hull, 2010).

After quantifying the risk and observing the consequences leads to the complex phase which concerns the selection of approach and instruments for risk management. Risks that are not

compensated by desired yield of financial institutions are avoided. It could make by selling financial assets which is burdened with this type of risk (e.g. loan securitization and/or entering into hedging transactions). The advantage of this method is that the risk from the beginning of economic loss event disappears or is significantly reduced. However, it also has certain deficiencies. As one of the deficiencies it is stated the inability to avoid all the risks to which the company is exposed. The second deficiency is that the risky activities, according to the rule, are profitable so the opportunity costs are high.

Transfer of risk implies the risk transfer, by which the financial institutions are exposed, on the market participants who are willing to take risk. It is usually realized by purchasing insurance, selling and purchase of receivables on the spot market and entering in transactions on the futures market. Some of the risks of financial institutions consciously take over. These are the risks that arise from the necessary daily activities, which are subjected to moral hazard or in which the hedging cannot be performed. When a decision is made to take a certain risk, it is necessary to define the methods for further managing with that risk. One of the proven effective methods for managing the risk is diversification of marketing by which the frequency reduces of both good and bad outcomes, which reduces the possibility of loss.

If it is not possible to perform efficient diversification of marketing, it is sometimes cheaper to set up a risk pool than pay for the insurance (Schroeck, 2002). If it is not possible to apply none of these mentioned instruments of risk management, is resorted to holding the required capital which depends on the projection of unexpected loss (Hull, 2010). It is about the capital amount which prevents the possibility of bankruptcies in a given period with a certain level of confidence.

For risks with high probability of occurrence and low level of risk the prevention and reduction of risk is recommended, while the risk with a high probability of occurrence and high intensity of risk a method of avoiding the risk is recommended. On the other hand, if a low probability of occurrence and the strong influence of risk a method that involves the use of insurance is recommended, while the risks that have a low probability of occurrence and low intensity the strategy of risk retention is recommended (Rejda, 2005).

In modern business conditions the process of risk management is to a great extent standardized. Organizations from all areas with the application of appropriate methodologies can successfully manage the risks. Risk management is fundamental for the insurance companies, because the basic assumption of the insurance existence is the presence of the risk. Only if there is a certain risk, the economic need for its coverage through the insurance also occurs.

### **Risk management of insurance companies**

Key risks in the insurance companies are the risks of insurance (property risks and the risks of life insurance), credit risk, investment risk (market risk, interest rate risk, currency risk, changes in securities prices), operational risks (people, processes, systems, external influences), and other risks (regulatory rules, reputation ...).

#### ***Insurance risk management***

When it comes to risk that arises from the insurance in order to minimize the consequence of negative influence of adverse events of the insurance company they develop large enough and homogeneous portfolio risk, providing several types of risks, taking into account the financial capacity, in other words the maximum retention, purchasing reinsurance coverage and make the transfer of risk to the capital market (Kočović and Šulejić, 2011).

## **ALTERNATIVE APPROACHES TO RISK MANAGEMENT IN INSURANCE COMPANIES**

---

In order to ensure the solvency of insurance companies it must possess an adequate amount of capital that should have to provide the coverage for the unexpected realization of high risks, but also the coverage for the negative deviation of actual from the expected returns, as well as the capital to cover all the exposure to the risks that appear in business. In this regard, there is a question of determining the optimal level of capital, in other words the capital level that will ensure the solvency and value creation. Solvency II directive presents the opportunity to improve solvency regulation of insurance companies and by introducing: a risk-based system, an integrated approach to security reserve and requirements regarding the size of capital, comprehensive framework for risk management, capital requirements defined by the standard approach, internal model of remuneration for the optimal diversification and risk reduction. From a financial aspect, reinsurance presents a replacement for capital that insurance companies must be "bound" to hold within the balance sheet in order to ensure solvency. Unlike insurances which reduce the standard deviation of the actual cost from the expected, reinsurance reduces the standard deviation of costs based on the costs for each insurer (Njegomir, 2011b).

Rising trend of number and intensity of adverse events required an overall risk management which involves the simultaneous use of reinsurance and alternative risk transfer mechanisms. Essentially it is a form of risk transfer such as the securitization of insurance risk, the use of derivative securities and contingent capital instruments. (contingent capital). Securitization allows the transfer of illiquid claims from the balance sheet of the insurance companies into the liquid securities that are invested on the capital market. In contrast to the securitization of receivables, financial innovation in the insurance sector is the possibility to transfer the risk from the point of liability insurers and reinsurers in marketable securities of capital markets. Thus, immobilized risk gets a liquid form.

Securitization allows the transfer of illiquid demand from the balance sheet of the insurance companies in the liquid securities that are invested on the capital market. Contrary to the securitization of receivables, financial innovation in the insurance sector is the possibility to transfer risk from the positions of liability insurers and reinsurers in the marketable securities of capital markets. Thus, the immobilized risk gets a liquid form.

Catastrophe bonds (cat bonds) present the most common example of securitization of the insured risks. Maturity period of these bonds coincides with the terms of the reinsurance contract, and that is twelve months. Catastrophe bonds are essentially corporated bonds that bring relatively high interest rates. If the insured case do not happen the purchasers of these bonds get the invested capital amount increased for high interest rate. However, if the insured case realizes the investors may lose the interest as well as the amount of the invested capital in these bonds.

The process of securitization considers that the reinsurer through the fund that he establishes negotiate a contract with an insurance company that wants to transfer insurance risk. The Fund (Special Purpose Reinsurance Vehicle) sales to institutional investors on the capital markets the bonds for catastrophe bonds. He retains the collected premiums from the insurers and raised money from the sale of bonds. The total amount of funds is investing in government bonds or the other high quality financial asset.

Another possibility for the transfer of risk is the use of financial derivatives for which a specific price is transferred from one to the other signatory, where the amount of loss and gain is equal to zero. Swap agreement, as the most frequently used derivative securities on the insurance and reinsurance market, allow the exchange of a series of fixed payments for a serie of variable payments whose value depends on the payment of the insured event.

In addition, as alternative forms of risk transfer on the capital market the contingent capital instruments are used which give a purchaser the right, in other words insurance or reinsurance company, on issuance and sale of securities with fixed price along with fixed period of maturity if

only defined event occurs. At that it is important to note that the requirement for their serie is that the cost of the realized event exceeds a predefined line, or predefined size of cost. In this way, the insurance companies issuing contingent capital instruments (stocks, bonds or some derivative securities) come to the missing funds on more favorable terms then that had been issuing at the moment when the loss has already occurred.

Alternative mechanisms of insurance risk transfer represents the consequent part of the mutual insurance sector with the other sectors of financial services. In this regard, relating the insurances and capital markets present a part of a broader trend of convergence in the financial services sector. Exposure to risks is growing relatively faster in comparison on the increase of the capacity of insurance and reinsurance market and in the future it can expect an increasing role of capital markets in managing the risks in the insurance companies.

### ***Credit risk management***

Credit risk is the risk of unperformed liabilities according to incurred debts. Exposure to a credit risk of the insurance company is present in case if it comes to the fall of credit solvency the issuer of the securities whose securities are in the portfolio of insurance company, reinsurers, brokers and other business partners who have obligations to the insurance companies. In this regard, the insurance company needs to identify, to assess and measure the risk in accordance with the creditworthiness of the debtor and his neatness of assessing obligations for creditors. By monitoring the solvency of the debtor credit the insurance company is able to take corrective actions, if the issuers do not pay their dept in defined time periods.

Apart from monitoring it is also necessary to perform measuring the credit risk that faces many difficulties. The classic way in which the credit risk is showing are the ratings. The external and internal ratings are distinguishing. External ratings provide special agencies which is a core business exactly creating a different rating for the various issuers of securities. Internal ratings are products of the very companies which depend on the criteria that they set. According to the Basel Committee on Banking Supervision it is provided that for purposes of calculating the required capital to leave the banks leave a choice between two approaches: a) standardized approach and b) approach of internal ratings measurement. Also, the Solvency II directive gives insurance and reinsurance companies the possibility to use the standard model of risk assessment as well as the internal models. Standardized approach allows that on the calculated risk exposure apply the risk weights in accordance with the evaluation ratings of the external agencies. On the other hand internal measurement of rating provides an opportunity for insurance companies to choose the way in which they will measure the rating. Although specific criteria on the basis for which the supervisory authorities will approve the use of internal models for each insurer and reinsurer are not specified yet, providing opportunities for application of internal results in risk management presents a revolutionary solution.

### ***Managing investment risk***

Investment risk makes the principal threat to the active side of the balance sheet of insurance companies. It is evident that it rarely can find the investors that concentrate their wealth in one type of security. Instead of that, they tend to invest in a diversified portfolio of securities. In that way it can reduce the amount of risk of the expected return that depends on the absolute risk of each investment in portfolios well as the connections that exist between individual investment within the portfolio. In case that the portfolio consists of the investments between which there is a low correlation of the variation range of the future expected returns it can be expected that the risk of achieving yield on total portfolio be less than the sum of the risks of the individual investments.

The risk of future yields is measured by dispersion of the probability that the yield will be higher or lower than the expected. As a statistical measure of dispersion the variance and standard

deviation are used. If a variance or standard deviation is higher, the greater and possible dispersion of future yields around the expected yield, in other words the investors uncertainty is greater. While the standard deviation for individual securities is much higher than for the portfolio securities, the average yield in individual securities is less than the yield of the portfolio.

The yield of the portfolio is the estimated yield of individual securities that makes the portfolio (Blake, 2000):

$$r_p = \sum_{i=1}^N \theta_i r_i \quad (1)$$

where:

$r_p$  - the return of risk portfolio,

$N$  - the number of securities in the portfolio.

$r_i$  - the return of  $i$ th securities in the portfolio,

$\theta_i$  - the estimated proportion of values in the portfolio contained in  $i$ th securities with

$$\sum_{i=1}^N \theta_i = 1$$

The expected return on portfolio is given by the estimated average for the expected return of the individual securities in portfolio:

$$\bar{r}_p = \sum_{i=1}^N \theta_i \bar{r}_i \quad (2)$$

where:

$\bar{r}_p = E(r_p)$  - the expected return of portfolio;

$\bar{r}_i = E(r_i)$  - the expected return of  $i$ th securities.

Using the equation (1) and (2), the risk of the portfolio is in the following way:

$$\begin{aligned} \sigma_p^2 &= E(r_p - \bar{r}_p)^2 = E\left[\sum_{i=1}^N \theta_i (r_i - \bar{r}_i)\right]^2 = \sum_{i=1}^N \sum_{j=1}^N \theta_i \theta_j \sigma_{ij} \\ &= \sum_{i=1}^N \sum_{j=1}^N \theta_i \theta_j \sigma_i \sigma_j \rho_{ij} \end{aligned} \quad (3)$$

where:

$\sigma_p^2$  - portfolio variance;

$\sigma_{ii} = \sigma_i^2 = E(r_i - \bar{r}_i)^2$  - variance of the  $i$ th securities;

$\sigma_i = \sqrt{E(r_i - \bar{r}_i)^2}$  - standard deviation of  $i$ th securities;

$\sigma_{ij} = E(r_i - \bar{r}_i)(r_j - \bar{r}_j)$  - covariance between return of  $i$ th and  $j$ th securities

$\rho_{ij} = \sigma_{ij} / \sigma_i \sigma_j$  - the correlation between return of  $i$ th and  $j$ th securities.

In order to measure the risk of portfolio securities it is necessary to know, not only the variance and standard deviation of each security that makes the portfolio, but also the correlation of the expected return of each securities, in other words the correlation coefficient. Diversification results from combining securities whose returns are less than fully correlated. Generally, the lower the correlation among the securities is, the greater is the impact of diversification on reducing variability (Alexander and Sharpe 1989).

The total portfolio risk decreases as the number of securities increases in the portfolio. So the threshold at which the total risk of portfolio is reduced to very low market risk (Fabozzi and Modigliani, 2003). Therefore the risk of completely diversified portfolio depends on the market risk (systemic risk). It is obvious that under conditions of the financial crisis and recession systematic risk significantly increases. The measure of systematic risk of the securities portfolio is  $\beta$  coefficient which measures the sensitivity of a particular portfolio yield to the changes of market return portfolio.

### **Operational risk management**

A key requirement that Solvency II imposes on insurance companies is related to capital allocation of adequate amount of capital to cover all the risks. Where in the capital requirements for the first time, except insurance risk, credit and investment risk, also includes operational risk, which presents the risk of loss that occurs because of inadequate or failed internal processes, people and systems or external influences. (Njegomir 2006)

The main objective of the operational risk management is establishing an adequate amount of the capital for its coverage, in order to satisfy the requirements of regulatory authorities, ensure better allocation of available resources and improve the solvency position of insurers. An adequate method for managing operational risk is an independent risk assessment which includes professional involvement, personal responsibility, continuity in business, continuous education of employees and resign and compliancy with policies, plans, procedures and laws. In this regard, the culture of personal accountability, openness and learning must be established.

Adequate operational risk management implies a precise defining of operational risk management framework at the level of the insurance company. With framework the principles and the processes should be defined in accordance which will be identified, assess, measure and control the stated risk. The main task is its early identification, prevention, avoidance and timely informing in order to achieve compliance with the established business objectives.

For operational risk which the insurance companies are subjected still there are no quantitative assessment but determining the impact of this risk is based on qualitative assessments that include analysis of various scenarios, Delphi analysis, decision tree analysis, the analysis of the shortest path using the network planning techniques etc. The choice of appropriate methods and techniques for managing the operational risk depends on the defined goals, established policies, the available personnel, time, budget and regulatory requirements.

### **Risk management in Serbian insurance companies**

The turning point in the development of the insurance sector in Serbia is the legislating Law insurance in 2004. National Bank of Serbia since that period, when the function of supervision was entrusted at managing the insurance sector, provided a number of sub-legal acts which have an aim to improve the system of supervision at managing the insurance companies as well as the control and risk management. Their main task is that the business of insurance companies be in accordance with international standards and trends.

## **ALTERNATIVE APPROACHES TO RISK MANAGEMENT IN INSURANCE COMPANIES**

---

Improving the regulatory framework in accordance with the standards imposed by Solvency II encounters some difficulties. Particularly, arbitrary regulation of solvency by the solvency margin takes into account only the exposure to risks associated with insurance, while the exposure to credit, market and operational risk is not taken into account during the calculation of the solvency margin. The need to identify all risks that insurance companies are exposed to impose the application of economic principles in creating realistic illustration of risks to which the insurance and reinsurance companies are exposed. It is also important innovation of expanded concept of risk management which involves pairing of economic measures of success (e.g, shareholder value) and the risk rather than accounting measures of the risk (e.g, quarterly earnings) and the appropriate risks (Đuričin, 2009a).

According to Solvency II directive imposes the need for implementation of a comprehensive risk management it takes time and resources to carry out a coordinated activities of management and control of insurance companies in terms of the risk. Furthermore it is necessary to provide an adequate and effective system of internal control of insurance companies that must be organized in depth, with multiple horizontal and vertical lines with all parts of the organizational chart of an insurance company. Internal control should be conceived in a manner to ensure operational efficiency, reliability of financial and nonfinancial informations, an adequate risk control, as well as the compliance with laws, policies and procedures. The number, character and condition of particular risks determine the diversity of instruments that are used in risk management.

When it comes to applying the approach to risk management under the Law on Insurance are explicitly suggested only coinsurance and reinsurance as forms of reducing the risks exposure. Approaching Serbia to the EU the changes can be expected in the domestic institutional and legislative framework in the direction of recognizing the role of capital markets in managing the risks in the insurance companies. It would have positive effects not only in terms of adapting the regulations for gaining the EU membership, but also in terms of improving the functioning of the insurance markets and capital market in Serbia. These two markets in the domestic environment are related only through the insurance companies investments in securities. Transfer of risk is achieved only through the reinsurance companies, in other words through coinsurance and reinsurance in the country and abroad. However, the proportionate share of the risk and associated premiums that insurers are transferred to reinsurers is relatively small and averaging in Serbia and the countries in the region amounts at about 10% (Njegomir, 2011a).

As part of further economic growth and economic development of Serbia there are many challenges before the insurances. Underestimation of liability insurance, an inadequate coverage of excess risks through the reinsurance, uncontrolled management of assets and liabilities, an inadequate system of internal controls, lack of projecting cash flows and comprehensive risk management process can lead the insurance companies to numerous problems related to the maintenance of solvency. Possible directions of further development can be seen through the experts recommendations of the World Bank which, among the rest, include: insurance supervision oriented to the risk; new product development of property insurance; education in terms of existing insurance products and the rights of the insured, as well as the liberalization of domestic reinsurance market.

The Serbia's opening for the world and development of the insurance sector also requires a gradual introduction of regulatory principles on which Solvency II is based. This would improve business and competitiveness of the insurance companies and achieve competitive advantages in relation to the insurance companies from the region.



## Conclusion

The global financial crisis and recession have indicated the threat of using the innovative financial solutions, high financial leverage, the failure to manage the risks in the financial sector and the growing connection between subjects in terms of increased exposure to the systemic risk. It is obvious that in such an environment the insurance companies need a new model based on the early identification of all risks and studying their mutual influence, as well as the expanding the concept of risk management that is based not only on avoidance but also using the risk. In this regard, the risk control must be more comprehensive. It basically does not necessarily mean an increasing capital requirements but the opportunity to make a stable environment for business and better use of available capital.

An effective system of managing the risk in the insurance companies include to clearly define the strategies and risk management policies, as well as carriers of the risk management system. In addition, it is necessary to define business processes and procedures for identifying, assessment, measuring and risk control, and also to define sophisticated models that provide diversification of risk and assessment of an adequate amount of capital. However, we must not lose sight that models cannot be a substitute for human. Particularly, risk management requires flexibility and adaptability of the process without rigid reliance on mathematical models of risk management that failed to identify the potential for systemic risk under conditions of global financial crisis. The global financial crisis and recession has clearly indicated the possible consequences of the absence of a comprehensive risk management, in other words an inadequate identifying of all risks and their interdependencies.

The application of risk transfer instruments in the capital market in the country and the region is not possible. In order to apply the alternative risk transfer instruments the accomplishment for a certain institutional and regulatory framework is necessary. In this context, regulation and accounting rules significantly affect the implementation of financial innovations, and thus the use of alternative risk transfer instruments. Although in Serbia the current regulations arbitrary regulate the solvency insisting on identifying the risk and allocate a sufficient amount of capital for their coverage may enhance the competitiveness of the insurance companies.

## Acknowledgments

This paper is a part of research project No. 41010, financed by the Ministry of Science and Technological Development of the Republic of Serbia.

## References

- Alexander, G.J. and Sharpe W.F. (1989). *Fundamentals of Investments*, Prentice-Hall, Enflwood Cliffs.
- Blake, D. (2000). *Financial Market Analysis*, John Wiley & Sons Ltd, Chichester.
- Crouhy M., Robert N. (2006). *The Essentials of Risk Management*, McGraw-Hill, New York.
- Đurićin, D. (2009a). Uočavanje i upravljanje rizicima u uslovima globalne ekonomske krize, *Ekonomika preduzeća*, vol. 57. br.1-2, 1-15.
- Đurićin, D. (2009b). Kako iz ekonomije moralnog hazarda preći u ekonomiju inteligentnog upravljanja rizicima: Slučaj Srbije, *Ekonomika preduzeća*, vol. 57, br. 7-8, 259-283.

## ALTERNATIVE APPROACHES TO RISK MANAGEMENT IN INSURANCE COMPANIES

---

- Eatwell, J. (1996). *International Capital Liberalization, The Impact on World Development*, Center for Economic Policy Analysis, New York.
- Elton, E.J. (2005). Modern Portfolio Theory, *Journal of Finance*, April, No.7-8, 7-21.
- Fabozzi, F., Modigliani, F. (2003). *Capital Markets – Institutions and Instruments*, Prentice-Hall, Inc, New Jersey.
- Hull, J.C. (2010). *Risk Management and Financial Institutions*, Pearson, Prentice Hall, New Jersey.
- Kočović, J., Šulejić, P. (2011). Značaj aktuarske i finansijske kontrole osiguravajućih kompanija za donošenje upravljačkih odluka, Zbornik radova: *Nadzor i kontrola poslovanja osiguravajućih kompanija*, Ekonomski fakultet Beograd, Beograd, 185 – 201.
- Markowitz, H. (1952). Portfolio Selections, *Journal of Finance*, 7(1), 77-91.
- Njegomir, V. (2006). Upravljanje rizicima iz ugla osiguravajućih društava, *Finansije*, Vol 61, br. 1-6, Ministarstvo finansija Republike Srbije, Beograd, 144-174.
- Njegomir, V. (2011a). Sistemski rizik i osiguranje, *Računovodstvo*, Beograd, broj 1-2, januar-februar, 89-114.
- Njegomir, V., (2011b). Primena alternativnih mehanizama transfera rizika u uslovima koje nameće Solvency II, Zbornik radova: *Nadzor i kontrola poslovanja osiguravajućih društava*, Ekonomski fakultet Beograd, Beograd, 397-421.
- Rejda, G. E. (2005). *Risk Management and Insurance*, Pearson education, Inc., Boston.
- Schroeck, G. (2002). *Risk Management and Value Creation in Financial Institutions*, John Wiley and Sons Inc., New Jersey.
- Sigal, S. (2008). Value-Based Enterprise Risk Management: the key to unlocking ERM potential, *Corporate Finance Review*, January-February.
- International Convergence of Capital Measurement and Capital Standards, A Revised Framework, Basel Committee on Banking Supervision for International Settlements, Basel, June 2004
- IMF Country Report No. 10/154: Eugene N.G. – Technical Note Insurance Sector, March 2010, p.19-22.
- A Global Framework for Insurer Solvency Assessment. Research report of the insurer solvency assessment working party, International Actuarial Association, 2004.
- PD ISO/IEC Guide 73:2002, Risk Management Vocabulary. Guidelines for use in standards
- Solvency II – Introductory Guide, Comite Europeen des Assurances, Brussels i Towers Perrin&Tillinghast, Stamford, 2006.
- International Convergence of Capital Measurement and Capital Standards, A Revised Framework, Basel Committee on Banking Supervision for International Settlements, Basel, June 2004.
- Službeni glasnik RS”, broj 55/04
- [http://www.nbs.rs/export/internet/latinica/20/zakoni/osiguranje\\_200561.pdf](http://www.nbs.rs/export/internet/latinica/20/zakoni/osiguranje_200561.pdf) (17 June 2012)

# SIZE AND LIQUIDITY OF STOCK MARKETS IN FORMER YUGOSLAVIA'S SUCCESSOR STATES

Dragan Stojković<sup>1</sup>

Srdan Marinković<sup>2</sup>

**Abstract:** *Since re-established in early nineties, stock markets in the countries successors to Ex-Yugoslavia passed through several phases. The initial rise of stock markets has been driven solely on privatization of state owned enterprises. The demand tackled policy differed from opening to foreign portfolio investments to some form of protectionism (Slovenia). The recent financial crisis has brought the reversal in cross-border flow of capital and made inevitable rapid drop in trading activity and liquidity indicators, although to a lesser extent to those countries, which from very beginning defended stock market against speculative capital inflow. In the paper, several different measures for size and liquidity (activity) are assessed: market capitalization, turnover volume and velocity, the number of companies listed and new stock issues. The paper also discusses perspectives of building an integrated regional stock market and some other policy options.*

**Keywords:** *stock market, former Yugoslavia, market liquidity, insider trading, IPO*

## Introduction

Building an efficient financial system plays central role within overall transition efforts. A well developed, efficient and equitable stock market is a building-block of an efficient financial market. Sometimes it is taken to be very symbol of market economy with far-reaching consequences on the entire economy. For instance, efficient stock markets promote equity finance as an alternative to more traditional intermediary finance.

Despite of being that important, the goal of establishing an efficient stock market proved not to be easily obtainable for many countries successors of former Yugoslavia. It took more than ten years of transition, and the goal is still far from being fully reached. The paper diagnose the current level development of stock markets that operate in the former Yugoslavia's successor states, addresses open policy dilemmas and looks for solutions.

The remainder of the paper is structured as follows. Second section reviews history of stock exchanges that currently operate within the region, with the focus on the most recent developments. In third section, we review the level of the development of the stock exchanges, their size and level of liquidity. Fourth section analyses main forces that drive stock market activity within the region. In fifth section, we are searching for policy options and perspectives. Final section concludes.

## History of stock exchange markets on the territory of the former SFRY

### *The historical ancestors of the stock exchanges*

Although, the first stock exchange dates back over five centuries, in the former SFRY countries, they were being established much later, in the late XIX century and early in the XX century. Ideas

---

<sup>1</sup> Faculty of Economics, University of Kragujevac, dstojkovic@kg.ac.rs

<sup>2</sup> Faculty of Economics, University of Niš

related to the establishment of the stock exchanges on the observed territory trace its very roots far before. However, they could not have been established with adequate regulations (Group of authors, 1995). According to Dugalić and Štimac (2005, p. 373) the conditions for their establishment were not there before the late XIX century, when adequate legal frameworks were established. The first that was established is the Belgrade Stock Exchange. It was in 1894. After the Kingdom of Serbs, Croats and Slovenes had been formed and after the annexation of the territories of Austro-Hungarian Empire, needs emerged for the establishment of other stock exchanges on the territory of the new state as well. Then, the Zagreb, Ljubljana and Skopje Stock Exchanges were established in 1919, 1924 and 1928, respectively. The Rule Book on the Establishment of the Delegation of Stock Exchanges, presented in 1927, with an aim to gather, represent and protect all domestic stock exchanges had a significant role in their development at that time. In addition, the new network of exchanges was aimed at facilitating, improving trading, and making stock exchange rules harmonized. In the period between the World War I and the World War II, the Belgrade Stock Exchange was highly esteemed, and ranked amongst the leading European stock exchanges. Unfortunately, the last session of the Managing Board of the Belgrade Stock Exchange was held on March 28, 1941. Formally, the Stock Exchange existed until 1953, when it was dissolved according to the Decision of the Presidium of the Serbian Government (see: Mićović, 2006, p. 10). The other regional stock exchanges had similar destiny. Faced with huge difficulties, the Zagreb Stock Exchange succeeded in continuing its operations all the way to 1945, when there was no longer any need for it as a “speculative institution” in the socialist system of that time. The Ljubljana Stock Exchange ceased to operate in 1942, for the same reasons as the Belgrade and Zagreb Stock Exchanges have ceased before.

### *New beginning: (Re) establishment of stock markets*

Although the capital market began to develop on the territory of the former SFRY relatively long time ago, it belongs to rather young and, observed in its entirety, insufficiently developed markets. The most important reason for such conditions lies in the non-existence of stock exchanges for almost five decades. In the system of communist rule, they used to be deemed a redundant and speculative institution, and, in that time, a large number of financial instruments were not to find on these territories. Although, social and economic reforms were initiated as early as in late 1980's, the Yugoslav capital market could not develop itself since the social property was sacrosanct at that time. The conditions for the reestablishment of the stock exchanges were created by enforcing a specific set of laws in 1989. Having once been enforced, the laws created the conditions for the renewal of the financial system in old Yugoslavia. Thus, based on the Act on Securities, the Securities Commission was established on 16th February 1990, as an individual and independent institution responsible for the trading and quality of securities. It operated on the whole territory of Yugoslavia of that time.

The Belgrade and Ljubljana Stock Exchanges were reestablished in 1989, whereas the Zagreb Stock Exchange began to operate again in 1991. Later, the other regional stock exchanges: Montenegro, Macedonian, Sarajevo and Banja Luka Stock Exchanges were established as well, in 1993, 1995, 2001 and 2001, respectively.

### **Stock market size and liquidity**

#### *The indicators*

The size of stock market is usually assessed according to several criteria: total number of listed companies, new listings, the number of initial public offerings, the (market) capitalization of listed companies, as well as turnover.

Contrary to measures of stock market size, many liquidity indicators, suggested by financial theory, are not operable even in some well-developed markets, let alone developing ones. For

example, price-based indicators, which capture cost of doing trade, either simple indicators like bid-ask spread, or the more sophisticated measures of market efficiency, demand data which are not readily available.

In terms of liquidity, the apparatus available to researchers often remains limited to some volume-based measures. The measures compare volume of trade (turnover) with the size of an equity market or size of an economy.

*The size of the equity markets on the territory of the former SFRY: An comparative analysis*

In following sections, we analyze the level of the development of the stock exchanges on the territory of the former Yugoslavia, in terms of their size and their liquidity. Firstly, we review the number of the companies listed on the stock exchanges (Table 1). Nevertheless, the role of a number of companies listed, as a development indicator, has to be scrutinized, since, in some countries, in the process of privatization, the companies were being obliged to enter the stock exchange where, later, they only formally existed without any market activity at all. The best example is the Serbian capital market, which operates with incomparably more listed companies than it is the case with all the other regional stock exchanges.<sup>3</sup> The new Act on Capital Market, enforced late in November 2011, will certainly contribute to keeping on the market only those companies that have a real interest to stay and which shares are expected to trade continuously. Table 1 accounts for the number of currently listed companies on all stock exchanges in the republics of the former Yugoslavia.

**Table 1. The number of listed companies and GDP**

Stock Exchange (State)	Number of companies (March, 15th, 2012)	Gross Domestic Product (2010; in USD mln.)
Banja Luka (BIH)	843	–
Belgrade (SRB)	1,288	38,423.23
Skopje (MKD)	79	9,189.45
Podgorica (MNE)	38	4,111.06
Sarajevo (BIH)	165	–
Zagreb (HRV)	231	60,851.86
Ljubljana (SVN)	67	46,908.32
Bosnia and Herzegovina (jointly)	1,008	16,577.88

Source: *Official websites of stock exchanges for the data on number of companies; IMF for GDP data.*

The number of companies listed has no strong significance for the development of a stock exchange. For example, total market capitalization depends not only on the *number* of listed companies, but also on their *composition*. We see that, although it has a relatively small number of listed companies, the Ljubljana Stock Exchange is surely the leader in development in comparison with the other stock exchanges that enter the peer group. A question arises: whose interest is it to have a large number of listed companies on a market whose shares are almost not traded? On the other hand, who is ready to invest in shares in companies completely closed for the public?<sup>4</sup> Certainly, this

<sup>3</sup> In Serbia, companies used to be bound to that by *The Privatization Act* (Službeni glasnik RS, 45/2005).

<sup>4</sup> In 2010, more than one-third of the 1800 companies present on the Belgrade Stock Exchange market had the label BP (bez prospekta / Without Prospectus).

## SIZE AND LIQUIDITY OF STOCK MARKETS IN FORMER YUGOSLAVIA'S SUCCESSOR STATES

is one of the fundamental reasons for the replacement of the previous general *Belexfm* index of the Belgrade Stock Exchange, which encompassed all shares of the free stock exchange market, with the *Belexline* index, which offers an incomparably more realistic picture of market trends and only includes actively traded shares.<sup>5</sup>

The data presented in next table (2) give us idea how misleading could be an assessment of stock exchanges' size based solely on numbers of companies listed. The data concerns market capitalization of listed companies. The market capitalization is simply the sum of market values of all companies traded at the trading venue. It is generated by multiplying the number of issued shares with the latest closing price. Table 2 shows current level and dynamics of market capitalization of listed companies in the period between 2004 and 2011 on all the observed stock exchanges. The value of the market capitalization of the companies is the one on 31st December for each consecutive year. Obviously, the ranking of stock exchanges significantly differs from the ranking given by considering the number of companies.

**Table 2. The market capitalization of the listed companies (in USD mln.)**

Year	BLU	BEL	SKO	POD	SAR	ZAG	LJU	B&H
2004	1,080.5	3,280.6	413.0	312.6	2,609.8	10,951.8	9,691.0	3,690.3
2005	1,766.3	5,408.7	642.8	1,027.2	3,912.0	12,946.2	7,942.2	5,678.4
2006	5,335.2	10,985.0	1,103.9	2,407.6	7,698.9	28,906.6	15,163.8	13,034.1
2007	6,196.8	24,056.4	2,703.6	3,698.7	11,686.3	70,653.2	28,963.0	17,883.2
2008	2,623.0	12,165.1	823.4	2,862.5	5,642.7	27,555.8	11,772.0	8,265.8
2009	2,820.7	11,521.5	922.2	4,289.2	5,261.1	26,598.6	11,766.0	8,081.8
2010	2,518.1	9,690.3	2,646.6	3,604.1	4,941.8	25,295.3	9,352.2	7,459.9
2011	2,415.0	8,364.8	2,504.3	3,321.7	2,900.9	22,452.4	6,305.0	5,315.9

Data source: *Federation of Euro-Asian Stock Exchanges (for Ljubljana Stock Exchange its website)*

**Table 3. The annual share turnover (in USD mln.)**

Year	BLU	BEL	SKO	POD	SAR	ZAG	LJU	B&H
2004	42.74	435.01	86.09	21.02	130.93	439.46	1,261.40	173.67
2005	69.98	584.89	140.77	88.33	349.69	797.36	4,779.77	419.68
2006	224.40	1,334.84	397.17	287.33	426.81	1,810.15	1,057.09	651.21
2007	411.10	2,530.23	654.59	375.43	887.22	4,088.16	2,878.73	1,298.33
2008	79.25	1,248.49	163.32	105.17	281.46	3,651.89	1,341.78	360.71
2009	34.59	562.12	65.14	327.65	153.69	1,414.98	1,034.35	188.29
2010	24.86	236.82	43.43	30.51	48.11	1,047.72	4,801.15	72.98
2011	44.71	333.48	51.23	77.85	60.10	1,011.47	5,104.23	104.82

Data source: *Federation of Euro-Asian Stock Exchanges (for Ljubljana Stock Exchange its website)*

As previously underlined, by introducing a company to the stock market one cannot create trading interest. Table 3 accounts for the total annual share turnover in the period from 2004 to 2011.

<sup>5</sup> Currently, only shares of approximately 10% of listed companies are actively being traded.

Both total market capitalization and turnover volume are absolute measures of market size. Since economies may significantly differ in their size, in order to make an indicator relevant for international comparisons, some ways to account for size of an economy is necessary. In what follows, we apply the procedure proposed by the World Bank. We review the size of the regional markets by comparing market capitalization with Gross Domestic Product. The table (4) presents the data on market capitalization to GDP ratio, for regional markets, EU and world leading economies.

**Table 4. Market capitalization to GDP ratio**

Year	BEL	SKO	POD	BIH	ZAG	LJU	Former SFRY	EU	World leading
2004	13.9	7.5	15.1	36.8	26.7	28.6	24.4	71.7	92.0
2005	21.4	10.7	45.5	52.8	29.0	22.2	27.0	74.1	96.7
2006	37.6	16.8	89.3	106.4	58.0	39.0	51.3	92.3	110.1
2007	61.8	33.1	100.0	117.3	119.1	61.2	85.7	92.1	118.8
2008	25.5	8.4	63.3	44.7	39.4	21.5	30.9	41.5	58.8
2009	28.7	10.0	103.6	47.4	42.0	24.0	34.5	60.1	85.4
2010	25.2	28.8	87.7	45.0	41.6	20.0	33.0	64.7	90.4

*Data source:* Federation of Euro-Asian Stock Exchanges (for Ljubljana Stock Exchange its website)

All the stock exchanges separately, as well as the regional market viewed in its entirety, conclusively with the year 2007, show increase in their market capitalization to GDP ratio. When the crisis arose in the second half of 2008, there was a more significant fall in the value of this indicator, which is the consequence of a rapid drop in stock prices.

The data reveal two more regularities. Firstly, it is the lagging of the stock exchanges from this territory behind the stock exchanges of the EU and the world leading economies. Secondly, the markets are strongly interrelated and mutually dependent, so that all the global movements are quickly transferred onto our region. Namely, prior 2008 all stock exchanges were booming, the same as they experienced common fall when the crisis hit and afterwards.

When assessing the level of the development of a stock exchange, the market capitalization is surely the most promising indicator, but it has to be considered together with some other indicators. That way one can get a more realistic picture of the current stance of development. Namely, as we have previously mentioned, in the privatization process, companies used to be forced to enter the stock exchange, but later a large number of them reported no market activity whatsoever. Such markets will probably have an inflated market capitalization with rather shrunk trading volume.

#### ***Liquidity of shares on the stock exchanges of the countries of the former SFRY***

The market (or asset) liquidity is an elusive concept. Despite of its unprecedented importance, it might surprise that there is no unique definition of it. When the liquidity of a market is concerned, the extent to which an asset trades quickly and continuously is usually taken to be a defining feature, i.e. this concept refers to a possibility of continuous trading (Dugalić and Štimac, 2009, p. 22). There are some other interpretations of the concept of liquidity, not significantly different from the previous one. For example, a market is said to be liquid once there are narrow spreads between best bid and offer quotes (Ritter et al., 2008, p. 100). Similarly, Myers and Rajan (1998, p. 733) used definition of liquidity as “the ease with which it can be traded, in the sense the more liquid assets, the greater their value in short-notice”, or similarly (Brili et al., 2010, p. 39), the capability of converting an investment into cash when it is needed. Then, a certain financial instrument can be said to be very liquid when it

## SIZE AND LIQUIDITY OF STOCK MARKETS IN FORMER YUGOSLAVIA'S SUCCESSOR STATES

is possible to convert into cash quickly, easily and at low costs (Cecchetti et al., 2011, p. 307). All the above definitions of market liquidity are insightful and by no means valuable, but they clash the most recent advances in market microstructure theory.

Amongst traditional definitions the most sensitive to the issue is the definition given in Holmstrom and Tirole (1998, p. 2), which state that “liquidity is related to the availability of instruments (market and nonmarket) that can be used for transfer wealth across periods”. The definition underlines both, for trading purpose equally important, sides of liquidity. Thus, an investment is liquid if a trader may easily convert it into cash (transferring future wealth to the present times) and *vice versa*, if a trader may easily convert cash into the investment (transferring wealth to the future). Defined as a ability to trade, “liquidity is the object of a bilateral search in which buyers look for sellers and sellers look for buyers” (Harris, 2003, p. 394). This mutuality is a novelty in everyday’s understanding of liquidity as a unilateral search process. It looks at the trading as a game in which some of market players supply, while some of them demand liquidity. For buyers, a seller who stands ready to accept an order to trade, helping trade to accomplish, actually supplies liquidity, the same as a buyer will supply liquidity to sellers if stands ready to trade with them.

There are several alternative explanations uniquely indicating that a bigger volume of trade must be implicative of greater liquidity. Firstly, the higher reported volume of trade may mean more traders presented at the market. The more traders presented at the market means that is less likely the market will be one-sided. It will be easier for buyers to find sellers and *vice versa*.

However, using a volume of trade to construct an indicator of liquidity comes with some problems. Namely, the same volume of trade may be with high number of small-size trades or with a small number of big-size trades. Small- and big-size trades do not perfectly substitute each other. They are traded according to different procedures and often in different venues, so that an big bid or big offer may mean nothing to small-scale traders.

In spite of the shortcomings, both indicators which we are going to use in the assessment of the level of shares liquidity on the regional stock exchanges include as numerator the annual turnover by shares. The first presented is the ratio between the total annual share turnover and the gross domestic product (Table 5), and the other one is the ratio between the total annual turnover and the market capitalization at the end of year (Table 6). The second ratio demonstrates how many times an average share turned over within a year. The higher the ratios are, the more liquid market is said to be.

**Table 5. The turnover to GDP ratio**

Year	BEL	SKO	POD	BIH	ZAG	LJU	Former SFRY	EU	The World
2004	1.8	1.6	1.0	1.7	1.1	3.7	2.1	78.0	95.1
2005	2.3	2.4	3.9	3.9	1.8	13.4	5.5	89.3	105.8
2006	4.6	6.1	10.7	5.3	3.6	2.7	4.0	105.4	139.2
2007	6.5	8.0	10.2	8.5	6.9	6.0	6.8	158.8	182.0
2008	2.6	1.7	2.3	1.9	5.2	2.5	3.3	104.0	135.7
2009	1.4	0.7	7.9	1.1	2.2	2.1	2.0	59.5	142.7
2010	0.6	0.5	0.7	0.4	1.7	10.2	3.5	51.6	104.6

Data source: *Federation of Euro-Asian Stock Exchanges (for Ljubljana Stock Exchange its website)*

It comes from the table above (5) that Slovenia seems better performing than the other countries in the region. However, it is not the case for all years within the period spanning from 2005 to 2010.



However, viewed in their entirety, all the markets within the region show very low level of liquidity. The overall impression of weak liquidity of the regional exchanges becomes rather strong when we compare it with the level reached in the EU and the world leading countries. The differences are enormous. In the world most developed economies, the total annual turnover on stock exchanges regularly exceeds the value of their gross domestic product. In the year 2007, it was at a level as high as 182 per cent of GDP. In the same year, EU countries reached a record level (158.8). Not surprisingly, immediately after the break up of recent financial crisis, this spread around the world in late 2008, the value of this indicator set up for falling.

It is also interesting that the value of the ratio changes in the wide range overtime. For some years it jumps on the level several times higher than average. The peaks appear more or less in every time series. However, the peaks are short lasting. Designed as it is, the ratio does not necessary indicate the change in the level of liquidity of existing trading material. The ratio is extremely susceptible on introducing new trading material. Because of that, it is less indicative of a real increase in trade interest and liquidity. However, we shall return to discuss this point a bit later.

The second ratio, which is able to portray the market liquidity, is built on comparing the total annual share turnover and the year-end market capitalization. It belongs to the volume-based liquidity indicators (Sarr and Lybek, 2002). This indicator is known as the turnover ratio or “turnover velocity” (Marinković, 2011a, p. 7). Stock exchanges characterized by high market capitalization, together with small trade volume, reports low turnover velocity.

**Table 6. The turnover velocity**

Year	BEL	SKO	POD	SAR	BLU	ZAG	LJU	Former SFRY	EU	The World
2004	0.13	0.21	0.07	0.05	0.04	0.04	0.13	0.10	1.09	1.03
2005	0.11	0.22	0.09	0.09	0.04	0.06	0.60	0.18	1.21	1.09
2006	0.12	0.36	0.12	0.06	0.04	0.06	0.07	0.10	1.14	1.26
2007	0.11	0.24	0.10	0.08	0.07	0.06	0.10	0.11	1.72	1.53
2008	0.11	0.20	0.04	0.05	0.03	0.13	0.11	0.10	2.51	2.31
2009	0.05	0.07	0.08	0.03	0.01	0.05	0.09	0.06	1.00	1.67
2010	0.02	0.02	0.01	0.01	0.01	0.04	0.51	0.09	0.80	1.16
2011	0.04	0.02	0.02	0.02	0.02	0.05	0.81	n/a	n/a	n/a

Data source: *Federation of Euro-Asian Stock Exchanges (for Ljubljana Stock Exchange its website)*

From the data above (Table 6) we clearly observe a problem of very low share liquidity on the stock exchanges of the former SFRY countries. In the period between 2004 and 2010, the total annual turnover by shares in the observed region had an average share of 6 to 18 per cent in the total market capitalization. When we compare the figures to those concerning the EU stock exchanges and the world developed countries, we see remarkable differences. Within the same period, only once did it happen that the value of the total annual turnover was below than the market capitalization. The turnover velocity in the EU and the world fluctuates within the range from 0.8 to 2.51. In the period from 1994 to 2003, with the exception of Austria, the turnover velocity for all developed markets in the world spans from 0.9 to 1.7 (Marjanović, 2004, p. 65).

The reported values of the second ratio are more persistent overtime than previous one. It means that the observed occasional sharp increase in turnover is accompanied with an increase in market capitalization as well. Such a development is simply an outcome of introducing new material to the stock exchanges. For example, in Serbia, during 2010 and 2011, two public companies became listed

on the Belgrade Stock Exchange (NIS – Novi Sad, and Nikola Tesla Airport – Belgrade), thus contributing to significant increase in both market capitalization and trade volume. In 2011, NIS reached an over 20 per cent share in the total turnover on the Belgrade Stock Exchange, and Nikola Tesla Airport - Belgrade had a share of approximately 5 per cent.<sup>6</sup> In the nearer future, in the first half of 2012, Telekom Serbia will also be visible in the market of the Belgrade Stock Exchange, so the total liquidity of the Belgrade Stock Exchange's market will substantially be improved. Thus, big public companies have an important role in raising the level of the total market liquidity. There was a similar situation in the other markets within the region, as well. On the Zagreb Stock Exchange, Croatian Telekom and Ina had a 38 per cent share in the total share turnover, 24.1 per cent and 13.9 per cent, respectively. On the Ljubljana Stock Exchange, companies with a major share of the state, either directly or through certain funds, also had a very high liquidity level (in 2011, Slovenia Telekom had around 5 per cent, Triglav Insurance around 4 per cent and Petrol around 7 per cent share in the total turnover by shares). Krka shares should specially be highlighted, making around one-half of the total turnover by shares (50 per cent and 44 per cent in 2010 and 2011, respectively).<sup>7</sup> On the Montenegro Stock Exchange, the share of Montenegro Telekom – Podgorica in the total turnover by shares was around 9 per cent in 2011.

Looking at the market liquidity may mask huge differences in liquidity of individual shares. The liquidity of whole market may be interesting only for those investors, which invest in well-diversified portfolio, the one close to the theoretical concept of market portfolio. However, it is rarely the case. Majority of investors pick up not more than ten shares so that individual share liquidity becomes the matter of higher importance. According to the liquidity assessment criteria defined by the Belgrade Stock Exchange, the companies listed on its stock exchange market had very low liquidity in late 2010.<sup>8</sup> Not a single share in the best quality segment of the market had the highest liquidity level (L1), i.e. their average turnover was no higher than ten million dinars, with no more than fifteen trades accomplished per a day (Stojković and Radivojević, 2010, p. 170).

### **From rapid growth to sudden break: The main drivers of stock market activity**

The privatization itself has played the key role in launching initial development of the stock exchanges on the territory of the former Yugoslavia. It helped create conditions for foreign portfolio investments to get into the region, while equally important were legal reforms that enabled all potential investors, both domestic and foreign, to be absolutely on an equal footing with each (Veselinović, 2003, p. 229). When the number of listed companies is concerned, two models differ concerning the impact of privatization on the capital market.

The first model encompasses the privatization of enterprises with the mandatory listing for companies after they have been privatized. The Serbian stock market is an example of this approach. If fully implemented, the approach delivers a market with large number of rather illiquid shares. As expected, the number of delisted companies over time outnumbered new listings. A similar situation was in the Czech Republic, where there were around 1,500 listed companies on the Prague Stock

---

<sup>6</sup> Note that Nikola Tesla Airport - Belgrade "entered" the stock exchange on 28<sup>th</sup> January 2011 and NIS - Novi Sad on 30<sup>th</sup> August 2010. Thus, the Airport's turnover is observed for the time period of 11 months.

<sup>7</sup> The Restitution Fund hold 14.99% of Krka shares, and the Capital Fund 9.86%. The share of other shareholders is very small, which makes Krka an interesting subject for investors.

<sup>8</sup> The criteria were set by the Decision on Setting Conditions for Conducting Market-Maker Business reached on 18<sup>th</sup> December 2009, The fundamental role of Market Makers (Liquidity Providers) is to contribute to an increase in a market liquidity

Exchange during 1995 and 1996. At the end of 1997, there were 276, and at the beginning of 2012, the number decreased to barely 26 listed companies.

The second privatization model has been applied in Poland and Hungary (Marjanović, 2004, p. 63). In the beginning, there was a small number of listed companies which increases as markets develop. At the end of 1994, there were 40 companies in Budapest, and 44 on the Warsaw Stock Exchange. Early in 2012, there were 61 listed companies on the Hungarian Stock Exchange, and 429 in Poland. Concerning the region, the model is the one typical of Slovenia. Late in 1994, there were 25 listed companies on the Ljubljana Stock Exchange, and early in 2012, there were 67. Moreover, at the start of new millennium, less than five per cent of total market capitalization was held in hands of foreign investors. Not only privatization model but also some capital market regulative isolates Slovenian capital market. For instance, Slovenia applied a regulative that made short-swings in foreign positions prohibitively costly. They literally forced foreign investors to take long-term position, what has made capital inflow from abroad rather marginal in generating overall demand for Slovenian shares. At the same time, the same approach has a merit to be able to keep the local market less fragile to the rapid capital outflow, which usually follows global financial meltdowns.

### *Post-crisis developments*

Yet, the strongest adverse impact on local equity markets came from a rapidly deteriorating global investment climate. The slowdown of trading activity, evaporation of liquidity and a rapid drop in the local markets' main indices, closely coincided with the similar developments on main global equity markets, and preceded to growing hostility of overall economic ambience.

Concerning turnover to GDP ratio, all local markets, the EU market, as well as leading world equity markets, the growing trend was broken around 2007. However, EU drops sharper than the world leading economies. In 2010, the indicator remains approximately a third its value in 2007, whereas it was around 60 per cent in case of global market itself. This is indicative of the fact that the EU member countries' stock exchanges are harshly hit by the current crisis than it is the case with stock exchanges in more developed world economies.

Regarding the values of this indicator, on the stock exchanges of the former SFRY republics cannot seriously be compared with the values achieved in the EU and the world. In the most successful year 2007, this liquidity indicator was no more than 6.8 per cent, which is indicative of the fact that a serious problem was related to the low liquidity of shares in this region.

Crisis-driven evaporation of liquidity forced the local markets to look for the path out in modifications of rules that govern system of trade. Break up of financial crisis brought some changes even into trading system and procedure. Since introduced on October 2004, continuous trading starts gradually replacing single-price auction. However, the global financial meltdown not only made the transition slow, but also reversed it. Sharp disappearance of interest even for common stocks of the best national issuers, brought frequent switch from continuous to single-price auction, so that the number of issuers, which stocks are traded continuously, dropped to a half of a number which they have during the market peak. Now, Belgrade Stock Exchange applies the system of continuous trading in trading common stocks of total 24 issuers, while the rest of stocks are still traded with single-price auction. The response, common to the countries across the region, was transition to hybrid trading systems. The majority of the trading venues introduced designated market makers as to supplement liquidity to their order driven trading systems. Nevertheless, since the low level of asset liquidity constrains even the designated liquidity suppliers to effectively generate additional liquidity, this novelty ended up with unconvincing ultimate results.

## **Policy options and perspectives**

### ***Regional capital market integration***

Stock exchanges, cooperating with each other and integrating, will be playing a very significant role in the further development of the regional capital market. Differently from small stock exchanges that will only “be struggling to survive”, only big stock exchanges have potential to survive. Integration can greatly be beneficial for increasing liquidity (Lee, 2007). In these processes, the Ljubljana Stock Exchange is the leader, and, differently from the other stock exchanges on the territory of the former SFRY, has a full membership in the World Federation of Exchanges (WFE) and the Federation of European Stock Exchanges (FESE). In late 2010, it gained accession to Xetra (Exchange Electronic Trading), thus significantly integrating more broadly. Also, cooperating with the Vienna, Budapest and Prague stock exchanges, the Ljubljana Stock Exchange formed the biggest group of stock exchanges in the South-East European region (CEE Stock Exchange Group), with the total market capitalization of EUR 128.5 billion in early 2012 (McCrary, 2011). The companies listed on these four stock exchanges within the CEESEG (there are 248 companies in total) represent around one-half of the total market capitalization of companies and the total turnover on all Central and East European stock exchanges. Of course, there is interest in further expanding this group, and a potentially valid membership of the Belgrade Stock Exchange in the near future would contribute largely to the improvement of the liquidity of its market.

As far as the cooperation amongst the stock exchanges of the republics of the former SFRY is concerned, the above short course in financial history told us it is not a novelty. Nevertheless, the foundations of its renewal were laid on 20th December 2007, by signing a Memorandum of Partnership. Based on the Memorandum, and aimed at further deepening this cooperation, several joint conferences in Zagreb, Ljubljana, Belgrade and Vienna have been organized so far. The following goals are pointed out as the main goals of this cooperation (Stojković, 2012): i) The development of the concept of regional products through directing regional and international attention to the region's key values; ii) The organization of joint conferences of investors for the biggest issuers; iii) The promotion of the regional markets through a shared website and short periodical reports on the performances of individual markets; iv) The development of comparable market indices and other joint projects as well as structured products in cross-markets.

We should mention that, regionally, capital markets are characterized by predominant share trading, whereas it is necessary that trading by other instruments as well, especially bonds, should be developed for it to grow further. On the stock exchanges in the region, state bond issuing is, for the most part, not so frequent. Besides, and apart from them, we should encourage a more significant issuance of municipal and corporate bonds in the market. It is known that they are extremely liquid securities which investors are very much attracted to. Table 7 presents the composition of the annual turnover achieved on the regional stock exchanges in 2011.

In addition to that, the regulatory framework should play an important role in further regional development. In Serbia, no sooner had the Act on Capital Market been enforced in late 2011 than insider trading began to be treated as a criminal act.<sup>9</sup> This Act will contribute to the development of the Serbian capital market in terms of transparency, equitable trading practice and particularly the protection of small investors. In Croatia, a similar act has been in force since January 2009.

---

<sup>9</sup> *Act on Securities and Other Financial Instruments Market*, The Official Gazette of the Republic of Serbia, No. 47/2006, Article 94.

**Table 7: The turnover composition: Selected regional stock exchanges in 2011 (in 000 USD)**

Stock Exchange	Shares	Bonds	Other
Banja Luka	44,715.3	84,757.7	–
Belgrade	333,485.9	55,294	–
Skopje	51,231.9	29,590.1	20,753.2
Podgorica	77,859.4	3,279.5	–
Sarajevo	60,109.6	16,865.4	–
Zagreb	1,011,471.1	104,639.9	–
Ljubljana	511,201.5	77,209.7	20,744.8

Data source: *The official stock exchanges' websites.*

### ***Structural flaws and economic ambience***

The stock markets in former Yugoslavia's successor states suffers from common structural weaknesses, which can not be assigned to the choice of trading system. New stock issues are quite rare, initial public offerings are absent for several years-long periods. We should always bear in mind the fact that Serbia is one of few countries in the world that has not succeeded in realizing even one initial public offering for shares (IPO). Apart from a number of novelties brought by the Act on Capital Market, an improvement is expected in that field as well. Private enterprises are not keen to going public and diversify their ownership structures (Marinković et al., 2012). In such an ambience, stock exchanges are still incapable of competing more significantly with alternative sources of financing.

Those developments critically downgrade the importance of stock markets for both financing economic growth and generating healthy corporate financial structure. Moreover, an ultimate outcome of trading process which has been taking place in last decade, was ownership consolidation, what transformed the market from stock trading venues to an arena for transferring corporate control. This process further undermined both trading activity and different parameters of market liquidity.

### **Conclusions**

Since re-established in early nineties, stock markets in the countries successors to Ex-Yugoslavia passed through several phases. The initial rise of stock markets has been driven solely on privatization of state owned enterprises. The demand tackled policy differed from opening to foreign portfolio investments to some form of protectionism (Slovenia). The difference between approaches is largely responsible for different dynamics in the next phase. The recent financial crisis has brought the reversal in cross-border flow of capital and made inevitable rapid drop in trading activity and liquidity indicators, although to a lesser extent to those countries, which from very beginning defended stock market against speculative capital inflow.

Despite of modern trading technology, even in tranquil times, the markets failed to achieve the level of activity even comparable to that of most advanced markets. Increased ownership consolidation of the largest joint stock companies transformed the stock markets into an arena for corporate control. From the other side, legal and regulatory framework was largely perceived not encouraging one for private owned enterprises to get open and diversify ownership. New issues stayed mostly regulatory driven while initial public offerings (IPO) were extremely rare. Delisting outnumbers new listing, what undermines the perspectives of stock markets to play the role of a respectable alternative to traditional credit finance.

### Acknowledgments

Authors are deeply grateful to the Ministry of Education and Science of the Republic of Serbia for the funds and support that made this research possible through its Research Project No. 179015 (Challenges and prospects of structural changes in Serbia: Strategic directions for economic development and harmonization with EU requirements).

### References

- Beogradska berza, Odluka o utvrđivanju uslova za obavljanje poslova market mejkera, 18.12.2009.
- Brili, R. A., S. Majers i A. J. Marcus (2010). *Osnovi korporativnih finansija*. Beograd: Mate.
- Cecchetti, S., K. Schoenholtz, and J. Fackler (2011). *Money, Banking, and Financial Markets*. 3rd ed., Irwin: McGraw-Hill.
- Dugalić, V. and M. Štimac (2009). *Osnovi berzanskog poslovanja*. Beograd: Stubovi kulture.
- Group of Authors (1995). *Beogradska berza 1894 – 1994*. Beograd: Beogradska berza.
- Harris, L. (2003). *Trading and exchanges: market microstructure for practitioners*. Oxford: Oxford University Press.
- Holmstöm, B. and J. Tirole (1998). Private and public supply of liquidity. *Journal of Political Economy*, 106 (1): 1–40.
- Lee, R. (2007). The Future for European Stock Exchanges. 17<sup>th</sup> *International Conference of the Zagreb Stock Exchange, Zagreb, mimeo*.
- Marinković, S. (2008). *Finansijska tržišta i finansijske institucije u Republici Srbiji*. Niš: Ekonomski fakultet.
- Marinković, S. (2011a). *Finansijska tržišta*. Niš: Ekonomski fakultet.
- Marinković S. (2011b). *Mikrostruktura finansijskih tržišta: savremena teorija trgovanja*. 2nd ed., Niš: Ekonomski fakultet.
- Marinković, S., I. Ljumović, and D. Stojković (2012). Going public and initial public offering: an exploratory study of motives from Serbian companies. *Industrija*, 40 (2): 125–143.
- Marjanović, M. (2004). *Proces privatizacije i tržište kapitala u Mađarskoj, Poljskoj, Češkoj i Sloveniji*, Beograd: Beogradska berza.
- McCrary, E. (2011). Guide to the CEESEG and its capital markets. Ljubljana: Ljubljanska borza, *mimeo*.
- Mićović, M. (2006). *Berzanski poslovi i hartije od vrednosti*. Kragujevac: Pravni fakultet.
- Myers, S. and R. Rajan (1998). The paradox of liquidity. *Quarterly Journal of Economics*, 113 (3): 733–771.
- Ritter, L., W. Silber, and G. F. Udell (2008). *Principles of Money, Banking, and Financial Markets*. 11th ed., Boston: Pearson Addison Wesley.
- Sarr, A. and T. Lybek (2002). Measuring liquidity in financial markets. IMF *Working Paper* 02/232, December, Washington, D.C: International Monetary Fund.
- Stojković, D. (2012). Integracioni procesi berzi sa područja bivše SFRJ i regionalna saradnja Beogradske berze. *Bankarstvo*, 41 (2): 32–49.
- Stojković, D. and N. Radivojević (2010). The limitation of application of continuous trading methods on the Belgrade stock exchange. In: *Contemporary Issues in Economics, Business and Management*. (V. Babić, ed.) Kragujevac: Ekonomski fakultet, 165–176.
- Veselinović, P. (2003). *Uticao institucionalnih rešenja na razvojne tokove nacionalne ekonomije*. Beograd: NIP Radnička štampa.
- Zakon o privatizaciji, *Službeni glasnik RS*, br. 45/2005.
- Zakon o tržištu hartija od vrednosti i drugim finansijskim instrumentima, *Službeni glasnik RS*, br. 47/2006.

# ELECTRONIC BANKING ON THE EXAMPLE OF PIRAEUS BANK

Slavoljub Milovanović<sup>1</sup>

**Abstract:** *Advancements in information and communication technologies (ICTs) and the great competition in banking sector have brought to emergence and development of electronic banking. New mode of giving services to customers by internet and the other ICTs have become method of differentiation between banks on financial markets becoming competitive more than ever. By offering and providing better electronic services, a bank can retain existing customers and attract new ones. Presently there is not a bank that does not have some form of electronic banking (e-banking) and the paper gives example of Piraeus bank which enables its customers to do e-banking transactions. Except this example of e-banking presenting options and capabilities that the bank provides to customers, the paper have theoretical background of e-banking.*

**Keywords:** *information and communication technology, internet, e-banking, case study*

## Introduction

In banking sector, great changes happened in last two decades. They are results of influence of political, economic, demographic and technological factors existing in developed and developing countries as well, but on the other side they are results of factors inside financial sector. New business philosophies of banks are oriented to need of clients. Giving services to their clients is increasing challenge for banks in last years. Expectations from banks are not only approving of loans, receiving of deposits and the other traditional banking services but wide range of the other services and conveniences. In that sense, level of interest on loans or deposits is not primary element for decision making of clients which bank's services to use. Whereas there is great competition between banks, they search for new modes for competing in order to attract new clients and to retain the existing ones. (Merisalo-Rantanen et al. 2009) (Acharya et al. 2006).

Electronic banking (e-banking) offers services that can differentiate a bank in comparison to competition and enable clients to do transactions by internet without going to bank. Range of traditional banking and payment services can be achieved from home by personal computer or mobile phone or from the other places with computer connected to internet. It is particularly convenient for those people who have not time to go to bank due to many duties and for those people who want fast and efficient service. (Farhoomand and Huang 2009) (AbuShanab, Pearson and Setterstrom 2009).

Namely, today there is not bank which can not offer e-banking services, so question is not does bank offer the services but which options are offered by e-banking (Nath, Schrick and Parzinger 2001). Main aim of this research is to present how e-banking systems are implemented and which services are offered on the example of Piraeus bank. Case study methodology is used to explain possibilities of these systems and conveniences which are offered to clients of the bank. This research also has theoretical background that analyses forms, advantages and disadvantages of e-banking. So the research is organized as follows: next section is dedicated to definition and categorization of e-banking services, third section explains various forms of e-banking, fourth section analyses advantages and fifth section disadvantages of e-banking, sixth section presents e-banking solutions in Piraeus bank and final section gives concluding remarks considering e-banking.

---

<sup>1</sup> Faculty of Economics, University of Niš, smilovan@eknfak.ni.ac.rs

### Definition and categorization of e-banking services

E-banking is very wide term that is difficult to define precisely. In that sense, online banking (Internet banking) is synonym for e-banking, but e-banking is wider term than Internet banking because encompasses achieving transactions by ATM, POS terminals and the other means. (Tallon 2010).

E-banking is defined as use of ICT in banking sector enabling users to do financial transactions without time and spatial boundaries posed by traditional banking. Funds transfer is facilitated by new distribution channels, such as EDI (Electronic Data Interchange) and Internet networks. E-banking is form of delivery of financial, principally banking services to clients offering them access to balances and changes of their accounts and initiation of transactions without need to go to bank. Some financial services offered through Internet are: making payments, checking account balance, fund transfer from one account to another, comparing interest rates on loans and deposits, access to currency rate, currency transactions, download of formularies and making applications for loans and deposits etc.

All e-banking services can be categorized into three groups: information services, communication services and transaction services. **Information** services are related to giving of information on products and services to clients. This category of services does not represent high risk for bank but it is important to develop efficient controls that prevent unauthorized changes of information for clients. (Benaroch and Kauffman 2000)

**Communication** services enable clients to make interactions with bank. Except to view certain data (for example, personal data of clients, data on transactions, balances, etc.) clients can change some data. In comparison to information services, risk with this category of services is grater due to direct connection between e-banking infrastructure giving information to client and the other parts of ICT infrastructure of bank. In creation and delivery of communication services, attention is focused to security of communication system and access authorization between applications of e-banking and databases containing personal data on clients and data on balances and changes of clients' accounts.

**Transaction** services encompass possibility of doing transactions with financial implications, such as making various kind of payments and funds transfers, trading of securities, etc. This category of electronic services contains highest risk and requires comprehensive controls in many areas such as security of network infrastructure, control of access rights, authentication of clients and employees of bank, administration of database records and enabling continuity of business.

Presently e-banking is not only new channel of delivery services to clients but tool for competitive struggle. In fact, there are not banks that do not offer conveniences enabled by e-banking services. Also banks realised that they can reduce transaction and the other categories of costs by e-banking. Namely, reasons for e-banking implementation are twofold: reduction of costs and gaining of competitive advantage by attraction of new clients. Therefore strategic benefits that can be derived from e-banking are: customer relationship management (a bank is focused to management of relations between its employees and clients and development of long-range collaboration with them), specialization to specific needs of clients (a bank tries to be leader in servicing small market segment and concentrates to problem solving of narrow set of clients), low price of services (a bank provides standardized services to great number of clients so makes lower costs and determines lower prices for its services).



### **Forms of electronic banking**

As we mentioned earlier, e-banking is wider term than internet banking and includes: Electronic Funds Transfer/Point of Sale (EFT/POS), Automated Teller Machines (ATM), Internet (on-line) banking, web TV banking and mobile banking (m-banking). (Nor and Pearson 2008).

**EFT/POS.** This form of e-banking supports non-cash payments where the terminals are connected to ICT infrastructure of banks. Client makes payments so that funds are directly transferred on account of merchant. EFT/POS system enables closer relations between clients and bank and retaining of existing clients of bank. By use of EFT/POS systems we can control validity of checks and identity of card user, make charge of buyer' account, reduce circulation of payment documentation etc. Benefits for the users of system are: faster non-cash payments, reduced cost of money transfer (payment operations), optimization of working assets, etc. Standard device installed in POS terminals besides credit card reader is optical bar code reader. By use of bar code reader, faster payment operations on cash desk and better evidence of inventory on stock are achieved.

**Automated Teller Machines (ATMs).** Special kind of e-banking particularly appropriate for citizens is use of ATMs. ATM enables self-servicing and electronic fund transfer (this is some kind of EFT system). This form of e-banking saves time of clients enabling them: efficient cash withdrawal, laying deposits, funds transfer to another accounts, access to data of balance account, etc. Banks can reduce number of tellers and operation costs and increase investments in new technology.

**Internet (on-line) banking.** This is form of interactive electronic banking based on use of global computer network (Internet). Clients of bank use personal computer connected to internet in order to access to data on theirs accounts. In theory this form of banking is also called virtual banking. Advantages of virtual banking refer to enabling users of internet to: pay bills, invest in securities, create their own currency portfolio and to get some advice and explanation from bank.

**Web TV banking.** Web TV banking is based on connection of television to internet in one system in whole. Web TV is dedicated to people who do not have computer but want to use internet services. Users connect their TV devices to web by standard telephone line. Management of web services is achieved by remote control containing simple commands. If they want, users can provide wireless keyboard that is identical to computer keyboard and to install printer. This form of e-banking except watching TV enables: home shopping, bill payments and home banking. In order to do these activities, users need to have smart card reader.

**Mobile banking (m-banking).** M-banking enables banking transactions through laptop, mobile phone, smart phone, tablet and the other portable devices equipped with special software for mobile, wireless access to internet. Users of these devices are the most important participants in this business, but there are the other participants such as network operator, financial institution and merchant. (Kim, Shin and Lee 2009).

All services are dedicated to users and they finance network by payment of their costs. In order to participate in system of mobile banking and business users have to possess appropriate device and connection to network. Network operator is intermediary in business and have duty to obtain authentication of user. The operator also must provide connection to the other networks and this service is known as a roaming. Financial institution is also intermediary in mobile business but in financial sphere and also has to obtain authentication of user. Further, the institution checks balance account of user and gives authorization of payment. Merchant as participant in mobile business provides products or services and receives money from user by mobile service. Merchant, also obtains payment system and pay fee for use of network.

Mobile technology enables users to buy and pay various goods and services, make banking transactions, access to contents and information from everywhere and in anytime. Advantages for users of mobile devices in achievement of banking transactions are following: personal independence (user's control, through mobile devices user can receive personalized set of services), easy to use (mobile service is ready to use for several seconds, simple use, comprehensible user interface), mobility (possibility of communication everywhere and anytime, users can carry mobile device everywhere, mobile device is platform for localized services), security (mobile devices support secured applications, privacy of user is protected).

### **Advantages and benefits of electronic banking**

Primary aim of banking system automatization was solving problem of payment based on paper documentations by use of ICT. Emergence of electronic money forced completely new philosophy of banking based on electronic data and money exchange and as we mentioned the philosophy is known as e-banking. Transition from traditional to electronic banking increases efficiency and competitiveness, provides better segmentation of market and gaining of new markets. Final result of this is increase of income and profit of bank. Although sometime e-banking was matter of prestige and reserved only for banks with highest rating, today its implementation is prerequisite for market survival. Presently almost all banks are aware of advantages and benefits of e-banking and have some form of online banking services. Therefore, advantages and benefits of e-banking are following: gaining competitive advantage, great possibilities for communication with clients, number of income sources is increased, self-service, satisfaction of clients and economic benefits of e-banking. (Howell and Wei 2010).

**Gaining competitive advantage.** Bank giving e-banking services increases competitiveness and its clients have impression that the bank is innovative and takes care of needs of its clients. Differentiation in regard to competitors can be achieved by e-banking if bank has skilled employees and financial resources.

**Great possibilities for communication with clients.** Communication is enabled by e-mail, call centers, internet questionnaires, on-line forums and online chats with responsible clerk of bank. Efficient communication is enabled without spatial barriers, because people today can have bank in their homes and offices, even on their own mobile phones.

**Number of income sources is increased** due to this mode of banking business increases possibilities for introducing new services for clients. In same time, internet is cheap source of information and provides services which are accessible anytime and anywhere so clients can be served worldwide.

**Self-service** 24 hours per day, 7 days in week and 365 days in year. Clients of bank can achieve wanted transactions on web site at whatever time. The clients do not have to wait in order and quality of banking service does not depend on expertise, concentration or mood of clerk in bank. Also users of e-banking services search for financial institutions themselves instead that the institutions search for clients.

**Satisfaction of clients** can be tracked easily because it is easier to get feedback on quality of service, price and some problem through internet then through traditional and expensive branch of bank.

**Economic benefits of e-banking.** Business costs are reduced due to smaller number of employees who deal directly with clients. Also, bank can increase number of clients without opening of new branches. Costs of development and maintenance of web site are relatively low in comparison to opening of new branch. E-banking can cause layoff of employees, but on the other hand it can make

need for new ones who are educated and trained in IT field. E-banking as innovation can reduce sale of traditional banking services because clients do not have to go to bank often in order to meet their needs. On the other side, sale of e-banking services is growing. Well designed and structured web site can inform user on services which a bank offer and motivate him/her to buy some of them. Reduction of business costs due to e-banking implementation enables banks to increase interest on deposits of clients and to improve the other services. E-banking is inexpensive form of doing banking transactions because fees for e-services are lesser than fees for traditional services. In traditional banking, more people, equipment and time are needed for doing transactions and that increases costs.

### **Disadvantages of electronic banking and security problem**

Fast development of e-banking was not followed by adequate legislative infrastructure. In many countries, legislative regulations significantly delayed in comparison to fast growing e-banking. Besides this disadvantage of e-banking, there is big problem of security of banking transactions and data (Yuen et al. 2010). Before explanation of this problem, we can mention the other disadvantages of e-banking, such as:

**Problems considering internet connection.** First problem of that kind is economic in nature and refers to cost of internet connection. Many people in economic crisis can not afford cost of computer and internet connection. Second problem is technical and related to operation of web applications and communication channels connecting user's computer and IT infrastructure of bank. Without adequate hardware, network and software configuration and internet access, e-banking services can not be used.

**Problems with ICT infrastructure of bank.** Sometimes malfunction of the ICT infrastructure can cause frustration of users who can not make transactions of e-banking. In this case, information systems (IS) which process users' requests and realize transactions are out of function.

**Competition on internet is strong and has not geographical limitation.** Many companies offering financial services all over country and world compete for every account of client. This is advantage from aspect of clients, but banks are exposed to great competition and faced with struggle to survive in turbulent market. In addition, if some financial corporation gains globally strong market position and misuses this dominant position, clients have problem

As we mentioned, security is one of very significant factor for development and operation of e-banking. Security problem often prevents clients to more use of e-banking. Computer of client for internet access to e-banking services is vulnerable point where security can be endangered. Aim of hacker's intrusion is to reveal number of account and code of user and to achieve illegal transaction. Therefore, some security risks in e-banking are:

**Risk of hackers' attack on IS of bank when many accounts can be endangered.** Development and implementation of e-banking poses morality issues considering increase of computer crime. In practice, hackers make intrusion in IS of financial corporations and banks, transfer funds to their accounts, break down IS of banks, remove and redirect of key information and deal with money laundering.

**Risk of unauthorized access to client's account and doing transactions by unauthorized person.** This risk is related to theft of clients' electronic identity. Banks have to protect privacy of their clients and prevent this kind of computer crime by countermeasures such as decomposition of transactions in small sets or use of coded database. As popularity of internet grows, threat of IS slowing down and breaking down made by hackers is increasing.

**Risk of so-called fishing.** Internet users can access to dummy of web site of specific bank and they do not know that it is not the real web site of bank. They can enter some data in adequate fields

such as user name and password. This data would be saved in computer of the web site owner who can access to account of client on real site and make illegal transactions. In order to prevent this abuse, some web browsers like Internet Explorer enable number of adjustment considering trusted web sites so an user can assess whether is on official web site of bank or on fishing site.

**Risk related to ATMs.** One of criminals' target is also ATMs containing great amount of cash for clients who need money momentarily. These machines are installed on remote locations where clients can be robbed. Criminals also can steal personal identification number or account number of clients, rob, remove or take ATMs.

Banks that use EDI technology in closed networks is more protected than banks using open infrastructure like internet. They use secure procedures for determination of identity and authorization of users accessing network. In open networks, existing mechanisms of technical and legal protection are not efficient enough to prevent unauthorized access and intrusion of hackers. New secure infrastructure is defined by specific cryptographic technologies such as authentication, digital signature and digital certificate. Main advantage of the infrastructure is higher level of message integrity and verification of access. Cryptographic methods provide following: protection of information secrecy and prevention of message content revelation, prevention of unauthorized modification of information (providing of information integrity), checking of sender identity (providing of information authenticity).

However, regardless of improvements in technologies and methods of protection, creativity of computer criminals stealing money from banks and the other financial companies is growing. With this creativity, they prey and undermine legal banking transactions.

### **Electronic banking in Piraeus bank**

Piraeus bank is one of four international Greek banks which does business in Serbia. Piraeus bank intensively uses ICT to do various business activities for purpose of increase of business efficiency and gaining competitive advantage as well. In addition, Piraeus bank uses ICT due to requirement of regulatory bodies and clients and intention of the bank to increase productivity and reduce costs.

Piraeus bank completely automated numerous operations related to various aspects of banking business. In fact, many operations which have done manually in past, presently are done by computer, internet and the other technologies. As it is already mentioned, the bank uses ICT in order to improve service to clients, compete with competitors and reduce cost.

Technical maintenance of e-banking web applications is assigned and outsources to specialised firm. Thereby, the bank is focused on banking operations and activities and not on technical operations of e-banking. Users of e-banking services have possibility to use excellent technical solution with highest level of security and data protection. All sent and received data is digitally signed and highest level of protection is guaranteed by this procedure

Piraeus bank has three systems of e-banking, so clients can use: 1. Piraeus Online Banking (SAGA e-banking) services, 2. Halcom e-banking services and 3. Asseco e-banking services. Among the other services of e-banking that the bank offers to clients, services of mobile banking (m-banking) should be especially defined. The bank has specially developed mini application that is dedicated to business clients (enterprises) and enables sending SMS notices and active SMS service for predefined number of mobile phone devices. Considering individual clients, the bank offers two basic services of m-banking: prepayment of mobile phone communication costs by SMS and money transfer through SMS.

SAGA e-banking is secure, fast and efficient system of Piraeus bank for doing business through internet with its clients. SAGA e-banking system enables clients to view balance and daily changes on

accounts rapidly and simply, to download statements (recapitulations) and receipts on payments from and to account, to make fast and secure payment operations in dinars and the other currencies, to access to currency rate, to transfer funds from one account to another, to download formularies for loans and deposits, etc.

User of this system can be every individual and business entity (organization) with current account. In order to use e-banking web servers of Piraeus bank, users must have Windows PC clients with Internet Explorer browser. In fact, Internet Explorer is only browser that enable use of e-banking SAGA applications. The other users who have browsers like Opera, Firefox, Chrome, etc. can not log in e-banking web servers of Piraeus bank

SAGA e-banking system is designed to create services with highest security level. Information that is exchanged with the bank is protected and can not be changed and intercepted. Security measures that the bank uses are following: coded communication, electronic signatures, combined protection with digital certificate on CD and PIN code and use of one time password.

Procedure for access to SAGA e-banking services is different for individual and business users. Main difference refers to use of smart card. Business users or organizations can access to e-banking services only by smart card, but individual users do not need smart card.

**SAGA e-banking for individual users.** In order to use e-banking services of Piraeus bank, users should submit request form for using these services and they get PIN code. Users can find page of e-banking services on web site of the bank (<http://www.piraeusbank.rs>) where they can enter user name and password that is illustrated on **figure 1**. Account number and PIN code are used as data for verification of account that is created, as we can see on **figure 2**.

Figure 1 Entry to web page of e-banking services for individual users

Figure 2 Creation of account for e-banking services

After creation of account, users every next time when log in system enter only user name and password that is generated as figure 1 shows.

**SAGA e-banking for business users (organizations).** Process of using e-banking services in Piraeus bank for business users is similar to process referred to individual users. Business users or organizations can access to e-banking services by smart card. When they access to e-banking services, they must choose type of smart card reader and enter PIN code, as we can see on figure 3. In process of authentication, users have possibility to change PIN code. Also, there is guide for use of smart card on web site of the bank.

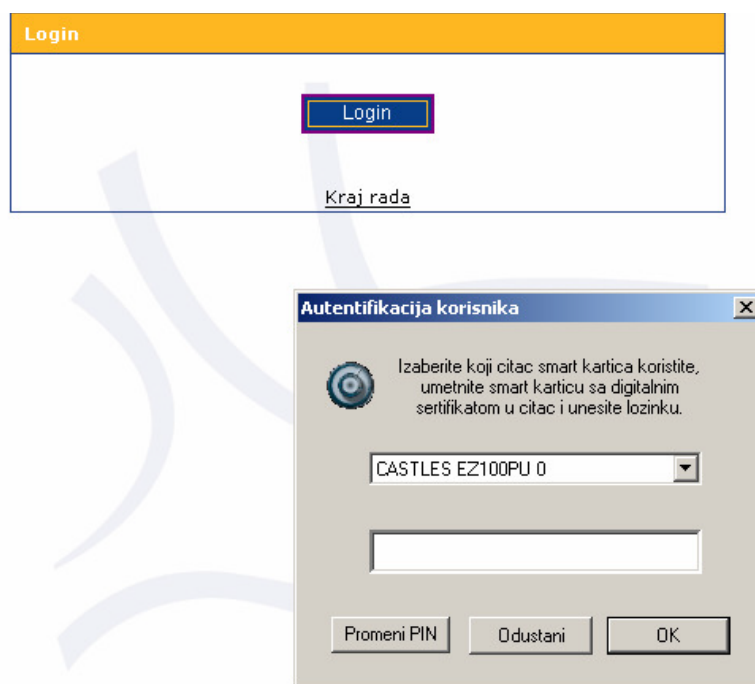

**Figure 3 Access to e-banking system for business users**

Besides SAGA e-banking system, Piraeus bank has Halcom e-banking system and Asseco e-banking system which can be used by individual clients and business clients as well. Halcom (<http://www.halcom.rs>) and Asseco (<http://www.asseco-see.com>) are IT solutions for e-banking operating independently from core e-banking system (SAGA e-banking).

**Halcom e-banking system.** Halcom e-banking services enable clients to deal with accounts in dinars and the other currencies. Clients also can link several accounts opened in different banks and use one digital certificate for all these accounts. Only prerequisite thing is that all banks where the accounts are opened use Halcom solution for e-banking.

In order to use Halcom e-banking services, individual clients should have account in one bank using Halcom IT solution, create and send request for electronic access right to account, fill and send request for user name and password assignment and make request for getting smart card. When clients become users of Halcom e-banking services, they have following conveniences: easy work with accounts and rapid getting of information, access to data on balance and changes of current account and credit card, payment of regular monthly bills for electric power, telephone, water, etc.

Similarly, business clients using Halcom e-banking services have following possibilities: with one smart card and application, users can deal with all their accounts in banks using Halcom IT solution, highest level of data security and protection (all sent and received data is electronically signed and users are sure that is not abused in transfer through public networks), users have updated information on account in one bank and all accounts in all banks, easy work with accounts and rapid getting of information.

**Asseco e-banking system.** Asseco system is second outsourcing solution for e-banking that Piraeus bank offers to clients. Like in case of Halcom, it operates independently from SAGA which is core e-banking system. This system is designed and developed for achieving financial transactions by computer networks and devices for access to the networks (PC, laptop, tablet, smart and mobile phone, etc.). It enables users to get information on balances and changes of their accounts and to make payments. Users can link several accounts in different banks and use one digital certificate for all these accounts, but these banks must have Asseco e-banking system.

Asseco e-banking system offers services through two applications: 1. FX web, 2. FX Client application.

**1. FX web** is on-line application that requires from users to have established internet connection when they work with their accounts (downloading statements, viewing balances, creation of accounts and making payments). FX Web service is available to business clients (organizations) and individual clients as well.

**2. FX Client** is off-line application dedicated to business clients. Users can create accounts in off-line mode and only when they synchronize and exchange data with bank, they have to be on-line. In case of synchronization, users receive data on account and status of sent payment orders. Clients can use several versions of FX Client application according to their specific business needs and specificity of their information systems. Main versions of the application are: FX Client Desktop (installation on one user's computer) and FX Client Enterprise (installation of the application on many computers in an organization and centralized database that can be accessed by many users in same time).

### Conclusion

In today turbulent environment, expectations from banks are not only approving of loans, receiving of deposits and the other traditional banking services but wide range of the other services and conveniences. E-banking offers services that can differentiate a bank in comparison to competition and enables clients to do payment and the other banking transactions by internet without going to bank. All e-banking services can be categorized into three groups: information, communication and transaction services. Advantages and benefits of electronic banking are following: gaining competitive advantage, great possibilities for communication with clients, self-service of clients, satisfaction of clients, increasing number of income sources and reduction of business costs. Piraeus bank is typical example of bank competing on Serbian financial market that tries to achieve these advantages and benefits. The bank implemented three e-banking systems: Piraeus Online Banking (SAGA e-banking) system, Halcom e-banking system and Asseco e-banking system. These systems enable clients to view balance and daily changes on accounts rapidly and simply, to download statements (recapitulations) and receipts on payments from and to account, to make fast and secure payment operations in dinars and the other currencies, to access to currency rate, to transfer funds from one account to another, to download formularies and make applications for loans and deposits, etc. All these conveniences are achieved on high level of security that obtains protection and integrity of data, control of access to accounts and authentication of users.

### References

- AbuShanab, E., M. J. Pearson and A. J. Setterstrom (2009). Internet Banking and Customers' Acceptance in Jordan: The Unified Model's Perspective. *Communications of AIS*, Vol. 2009 Issue 26, pp. 493-524.
- Acharya, R. N., A. Kagan, M. G. Sobol and V. Kodepaka (2006). Competition and Adoption of Internet Technologies by Texas Community Banks. *e-Service Journal*, Vol. 4 Issue 3, pp. 61-76.
- Benaroch, M. and R. J. Kauffman (2000) Justifying Electronic Banking Network Expansion Using Real Options Analysis. *MIS Quarterly*, Vol. 24 Issue 2, pp. 197-225.
- Farhoomand, Ali and M. Huang (2009). Does IT Payoff? Strategies of Two Banking Giants. *Communications of AIS*, Vol. 2009 Issue 24, pp. 821-836.
- Howell, J. and J. Wei (2010). Value Increasing Model in Commercial E-banking. *Journal of Computer Information Systems*, Vol. 51 Issue 1, pp. 72-81.
- Kim, G., B. Shin and H. G. Lee (2009). Understanding dynamics between initial trust and usage intentions of mobile banking. *Information Systems Journal*, Vol. 19 Issue 3, pp. 283-311.
- Merisalo-Rantanen, H., M. Rossi, P. Hallikainen, K. Nurmiäki (2009). User Influence in E-Service Evolution: A Case Study of E-Banking. *Communications of AIS*, , Vol. 2009 Issue 24, pp. 719-738.
- Nath, R., P. Schrick and M. Parzinger (2001). Banker's Perspectives on Internet Banking. *e-Service Journal*, Vol. 1 Issue 1, pp. 21-36.
- Nor, K. M. and M. J. Pearson (2008). An Exploratory Study Into the Adoption of Internet Banking in a Developing Country: Malaysia. *Journal of Internet Commerce*, Vol. 7 Issue 1, pp. 29-73.
- Tallon, P. P. (2010). A Service Science Perspective on Strategic Choice, IT, and Performance in U.S. Banking. *Journal of Management Information Systems*, Vol. 26 Issue 4, pp. 219-252.
- Yuen, Y. Y., P. H. P. Yeow, N. Lim and N. Saylani (2010). Internet Banking Adoption: Comparing Developed and Developing Countries. *Journal of Computer Information Systems*, Vol. 51 Issue 1, pp. 52-61.



# ROLE OF PENSION FUNDS IN THE FINANCIAL SYSTEM OF SERBIA AND COMPARATIVE VIEW WITH THE STATES OF SOUTH EAST EUROPE

Milena Lutovac<sup>1</sup>

Miloš Lutovac<sup>2</sup>

**Abstract:** *Although the pension fund, social security and health care have always been important factors in economic growth and development, they have lately been moved to the foreground. Pension funds in developed countries represent important financial investors. Significant funds of these financial institutions are placed on the capital market, thus supporting the development of those markets, which through feedback influence the development of pension funds. In developed pension systems, besides the pension plans within the social security, available are the plans that allow important part of one's total compensation to be insured, for example the plans sponsored by employers or individual pension plans.*

*The aim of this paper is the review of the functioning of the pension system in Serbia, which will in some modified form occupy a very important position within our future reformed pension insurance system.*

**Keywords:** *pension system, flat-rate pension, taxes, social insurance system, pension funds, financial market.*

## Condition of pension system in the Republic of Serbia

Social infrastructure, as considered today by contemporary economic science, involves numerous and diverse activities: education, health care, social and pension insurance, culture, scientific research and development, political organizations, government organs and civil society organizations. (Lutovac, 2009) While all these activities are different in character, all of them are characterized by the fact that their products and services are specific items that are generally not traded in the market, according to economic laws, but they represent common goods of the whole society or its individual parts. (Lutovac, 2009)

Pension and disability insurance in any country, including Serbia, draws attention primarily of its scientists and experts in general, who are involved in researching it from different points of view. The organization itself and the functioning of pension and disability insurance is the subject of discussions and comprehensive analysis of experts in this area, in almost all countries of the world.

The costs, i.e. expenditures that the governments set aside for pension systems have become a major problem for both developed and undeveloped countries, as well as countries in transition such as Serbia. Unfavorable demographic structure in the Republic of Serbia, i.e. the ratio of the number of employees and pensioners is steadily declining. This ratio, and problems in the functioning of the national economy, were a condition for the introduction of high taxes on earnings, for both employees and employers, based on which pension compensations are paid. High fees have influenced the worsening of the financial situation of employees and employers, and have also lead to enormous problems in the economy, causing many companies to stop operating or to work under difficult

---

<sup>1</sup> Faculty of Economics, University of Belgrade, milenalutovac@ekof.bg.ac.rs

<sup>2</sup> Higher School of Professional Business, Novi Sad

## **ROLE OF PENSION FUNDS IN THE FINANCIAL SYSTEM OF SERBIA AND COMPARATIVE VIEW WITH THE STATES OF SOUTH EAST EUROPE**

---

circumstances. Pursuant to these problems, there are also problems in paying workers' salaries, as well as fees for pension and disability insurance. (Lutovac, 2006)

As a consequence of difficulties in the functioning of pension and disability system, there are disturbances in the functioning of pension funds, i.e. irregular payment of pensions. That is why some countries of Southeast Europe have reformed their pension systems, whereas a large number of countries have started with the reforming or are planning to implement it in the future period. (Rakonjac, 2004)

The pension insurance system in Serbia, as well as in other countries of Southeast Europe (we primarily refer to states that belonged to former Yugoslavia) has for many years been in a severe crisis, so it works with large problems that are difficult to overcome. It is quite evident that this insurance system is economically not efficient and socially unacceptable, and therefore it should be reformed in the future period.

### **Basic characteristics of pension system in Serbia**

There is a large number of characteristics that we could identify and refer to in the framework of functioning of pension and disability system in our country since 1980, until the present day, i.e. 2012. The most important characteristics are the following:

1. Ratio of the number of beneficiaries and number of active insured persons, i.e. employees,
2. Average number of years of employment necessary for retirement, as well as years of age,
3. Consideration of financial status of beneficiaries and their average earnings,
4. Monitoring compliance system of pension compensations,
5. Movement of fee rates,
6. Monitoring financial position and operations of Pension and disability insurance fund,
7. Movement of age limit for retirement.

The facts that are relevant for our analysis are those that the beginning of the eighties in Serbia and other republics of the former Socialist Federal Republic of Yugoslavia were marked by stagnation and continuous decline of economic activities. That situation got increasingly worse, and in 1992 it transformed into an enormous economic crisis, followed by hyper inflation and the collapse of the country, as well as blockade and sanctions (for the Republic of Serbia and Montenegro) by the United Nations Security Council. (Jovanović-Gavrilović, 2004) In the first half of the nineties, the problems in the pension fund amplified dramatically. In the period between 1989 and 1994, GDP fell by two thirds, open and concealed unemployment increased, which lead to a decline of real wages. Some companies and industries had their fee rates reduced, whereas the number of pensioners at that time increased significantly due to early retirement of workers. Large deficit back then was covered by primary emissions which in turn accelerated hyperinflation and devalued pensions.

In the period between 1994 and 1998, the revenues from fees and pensions grew realistically due to the abolishment of sanctions and acting of Avramović's program to stop hyperinflation. The deficit back then was covered by transfers from the budget, whereas government regulations illegally reduced pensions. There were also delays in payment of pensions. In 1999, NATO bombing of Serbia and Montenegro caused the plummeting of economic activity by 18%, which reduced revenues and fees, and therefore pensions also. Very harsh social situation in the country, poor economic situation and poverty affected the difficult functioning of pension funds system, that was in part reflected in the increased participation of PDI expenditures in GDP and national income. (Devetaković, et al., 2005). The current system of pension insurance of employees in Serbia consists of one level, i.e. it is a one-piece, mandatory and public system with predetermined retirement compensations. This system,

which is in use in our country, works according to the “PAYG” principle, under which the current employees finance pension compensations of current pensioners. This is a so-called current concept of financing. This concept of financing is very susceptible to demographic changes in the country and can work well only when the population is young, i.e. when there is a larger number of employees than the number of pensioners. The ratio of numbers of employees and pensioners during the previous decades has significantly decreased, due to: 1. unfavorable demographic trends, 2. decline in employment, 3. low age limit for retirement, 4. widespread practice of early retirement, 5. generous policy of granting accelerated retirement plans.

**Table 1. Ratio of numbers of employees and pensioners**

<b>Year</b>	<b>1970.</b>	<b>1980.</b>	<b>1991.</b>	<b>2000.</b>	<b>2005.</b>	<b>2008.</b>
No. of employees / no. of pensioners	3,8	3,5	2,3	1,7	1,6	1,5

Source: Arsić, M., (2010), Public pension insurance, Faculty of Economy, Belgrade.

The ratio of numbers of employees and pensioners has been deteriorating from one year to another. Thus, this number was 3,8 employees per one pensioner in 1970, then gradually started to decline during the eighties, and, in the nineties, reached the number of 2,3 employees per one pensioner. The declining trend of the number of employees and pensioners continued during the 2000s, from 1,7 in 2000, through 1,6 in 2005, it dropped to 1,5 in 2008. Because of the present situation in the economy of Serbia, where a large number of companies works with only a part of their capacity or does not work at all, the ratio of numbers of actual employees, held at the National Employment Service, and pensioners is about 1:1, which represents a very hazardous situation.

In addition to a very unfavorable ratio of numbers of employees and pensioners, there is also a high ratio of average pension and average salary. Pension/salary ratio is over 70%, which puts Serbia at the very top of the global list. This ratio was 78% in 1999, in the state union of Serbia and Montenegro, whereas a slight decrease occurred in 2000 when this ratio was 75,9%. On the territory of the Republic of Serbia pension/salary ratio in 1999 was 78%, and 71% in 2000, which can be seen from Table 2.

**Table 2. Pension/salary ratio in serbia and other countries**

<b>COUNTRY</b>	<b>%</b>
SERBIA	70,0
MACEDONIA	42,8
HUNGARY	64,2
POLAND	48,7
GREECE	33,5
GERMANY	45,2

Source: Jugoslovenski pregled, no. 1/2001., p. 97, in Antić Rakonjac, T., (2004), Dobrovoljno penzijsko osiguranje, Faculty of Economy, Belgrade, p. 255.

In addition to the foregoing, there were also characteristics such as delays of one month in the payment of pensions to the employees fund, i.e. the pensions for the previous month were paid in the current month. Either way, the crisis of pension insurance system in our country continues, lasts even today with a large possibility to become even bigger and more expressed if the reforms of this system do not commence.

### **Reforms of Serbian pension system**

The necessity for reforms of Serbian pension system is a consequence of problems that had accumulated during the previous period, such as large deficit, ratio of numbers of employees and pensioners, arrears in the payment of pensions, expected negative demographic tendencies in the future. All these causes had such an effect that, in the period between 2001 and 2009, several changes of pension system were introduced. Generally speaking, all implemented reforms were aimed at improving long term sustainability of the pension system. In the first phase of reforms during 2001, the most significant changes referred to:

1. Increase of retirement age limit from 60 to 63 years of age for men and from 55 to 58 for women, and also the minimal age limit, from 50 to 53 years of age,
2. Introduction of Swiss formula for indexation of pensions, according to which pensions were indexed to the weighted average of growth of average salaries and living costs,
3. Reduction of fee rate from 32% to 19,6%, but the inclusion of other personal earnings in salaries increased the base for calculating fees for about 20%,
4. Abolishment of selective reductions or exemptions of certain activities and companies from paying fees. (Arsić, 2010)

The most significant results of this phase of reforms were securing regularity in the payment of pensions, as well as significant real growth of average pensions. However, the financial results of the Serbian pension fund did not improve then due to the excessive growth of real pensions.

The second phase of reforms, implemented in 2003, contained the following changes:

1. Determination of pensions based on earnings over the entire work life, rather than on the basis of earnings in the ten most successful years during the years of service,
2. Broadening of the base for calculating fees by including income from royalties and other similar stuff,
3. Tightening the procedures for obtaining disability pensions, and reducing benefits for certain categories of employees.

The changes of the pension system that were implemented during this period improved the fairness of the pension system and reduced abuses, but their scope, from the viewpoint of improving financial performances, was relatively modest.

The most important reforms in the pension system, adopted in 2005, included the following changes:

1. Gradual abandonment of the Swiss formula in the indexation of pensions through reducing the weighting with earnings, in order to index pensions in 2009 exclusively according to the costs of living,

2. Gradual extension of the retirement age limit, so that in 2011 the age limit would be 65 years of age for men and 60 for women,
3. Introduction of a minimal ratio of the average pension and average salary at the level of 60%.

Improvements of financial performances of the pension system appeared as a result of these reforms. The deficit of the pension fund in 2007 was lower by 1,6% of GDP compared to 2003, whereas the expenses of the pension fund in 2007 were lower by about 0,9% compared to their maximum in 2004.

In 2008, a set of measures was introduced, which completely neutralized the positive financial effects of the reforms of the pension system in the period between 2001 and 2007, such as: 1. harmonization of the ratio of average pension and average salary at the level of 60%, which resulted in the growth of average pensions by about 12%. Also, at the end of 2008, the average pensions were exceptionally increased by 10%. As a result of these measures, the share of pension expenditures in GDP in 2008 increased by 1,2 percentage points. At the same time, the pension fund deficit in 2008 reached 5,7% of GDP, and in 2009 the deficit was more than 6% of GDP, which was above the 6% maximum achieved in 2003. As a response to the abovementioned unsustainable increase in pension costs, the state froze the growth of pensions in 2009 and 2010.

### Structure and financing of the public pension system in Serbia

At the end of the first decade of the 21<sup>st</sup> century, the pension system in Serbia consisted of:

1. Mandatory public pension fund – the Republic Fund for Pension and Disability Insurance, whose expenses in 2008 (pensions, health care for pensioners, administrative costs etc.) were 14,4% of Serbian GDP and amounted to about 1/3 of the consolidated expenditures of Serbia,
2. Ten voluntary and private pension funds, which included about 160 thousand insured persons. The total value of net assets of private pension funds at the end of the first quarter of 2009 was about 50 million Euros, which amounted to about 0,2% of GDP. (Arsić, 2010)

By uniting pension funds of employees, farmers and self-employed persons, a uniform pension fund was formed in early 2008. The inclusion of military pension fund into this uniform public fund is also expected.

**Table 3. Number of insured persons and pensioners in public pension fund in serbia (in thousands)**

	<b>INSURED PERSONS</b>	<b>PENSIONERS</b>	<b>INSURED PERSONS /PENSIONERS</b>
<b>EMPLOYEES FUND</b>	2000	1307	1,5
<b>FARMERS FUND</b>	310	223	1,4
<b>SELF-EMPLOYED FUND</b>	250	51	4,9
<b>TOTAL</b>	2560	1581	1,6

Source: [www.pio.rs](http://www.pio.rs)

## ROLE OF PENSION FUNDS IN THE FINANCIAL SYSTEM OF SERBIA AND COMPARATIVE VIEW WITH THE STATES OF SOUTH EAST EUROPE

---

Financing the public pension system is performed according to the following fee rates. The basic fee rate is unique and it is 22%, of which half goes to the expense of the employee, and half of the employer. At the same time, the base for paying fees to the PDI fund is the same as in the case of health insurance. Minimal monthly base for paying fees is 35% of the average salary, and the maximal base is equal to five times the average salary.

A more detailed review of the fee rates for public pension fund in Serbia and other countries of Southeast Europe is given in Table 4.

**Table 4. Fee rates for public pension funds in Serbia and other countries of Southeast Europe**

COUNTRY	FEE RATE FOR PENSIONS
SERBIA	22,0%
BULGARIA	22,0%
HUNGARY	18,0%
MACEDONIA	21,2%
ALBANIA	29,9%
FEDERATION OF BOSNIA AND HERZEGOVINA	24,0%
REPUBLIC OF SRPSKA	24,0%
CROATIA	20,0%
ROMANIA	19,8%
MONTENEGRO	21,6%

*Source: Arsić, M., (2010), Public pension insurance, Faculty of Economy, Belgrade, p.18.*

The current pension system in Serbia is unsustainable in the long term, since pension expenditures „squeeze out“ other social and developmental functions of the state. (Rakonjac Antić and Kočović, 2008). In the period between 2003 and 2008, revenues from fees and other regular revenues accounted for between 56% and 66% of expenditures of public pension fund. Pension fund deficit ranged from 4,4-6% of GDP. The deficit of the pension fund was mostly covered by transfers from the state budget (about 5,2% of GDP), and in a smaller part by privatization revenues (about 0,4% of GDP).

The sustainability of public pension system in Serbia depends on:

1. demographic variables: average life expectancy, age structure of the population etc.,
2. macroeconomic variables: GDP growth, growth of employment and average salaries,
3. fiscal parameters: fee rates, fee bases,
4. pension system parameters: age limit and minimal limit for retirement of men and women, rule of indexation of general points and indexation of pensions, conditions for early retirement, conditions for accelerated retirement and more. (Everett, 1999).

The influence of demographic factors is relatively predictable and they will adversely affect the sustainability of the pension system in Serbia. It is expected that the ratio of population older than 65

years and the working population will increase from 25% in 2007 to about 35% in 2032. ( According to the estimates of the Republic Institute for Statistics). Macroeconomic variables will probably positively affect the sustainability of the pension system, but the intensity of their impact is uncertain. The impact of fiscal variables with increased fee rates would improve sustainability in the short term, but would worsen the competitiveness of the economy, which would in the long term adversely affect the pension system as well. Also, a certain increase of sustainability could be achieved by improving the collection of fees from farmers, entrepreneurs and small businesses.

Pension funds as participants in the financial market in Serbia are placed in financial contractual institutions that, along with banks and insurance companies, represent active participants in the financial market. (Kočović and Šulejić, 2006). These funds result from payments of fees of participants and they are managed in order to maintain and increase their value to secure payment of pension compensations to members of pension funds. Pension funds are the property of the insured, i.e. members of the fund depending on the amount of assets on individual pension accounts. (Rakonjac Antić, 2004). Assets of pension funds, especially private ones, are considered extremely high quality, thanks to their characteristics: large scale and long investment opportunities. Therefore, we can say that pension funds are one of the most significant institutional investors in the financial market, since their large purchases and sales may be crucial in directing price movements in the financial market as a whole. ( Pitić, et al., 1996)

The voluntary pension insurance system in Serbia is at the beginning of its development. According to the report of NBS in our market, at the end of the third quarter of 2007, the number of contracts signed with companies for management of voluntary pension funds was 143064. Net assets in the sector of pension funds was about 2,6 billion dinars in September 2007. (www.nbs.rs., Data from the Sector of voluntary pension funds in Serbia – Report from 3<sup>rd</sup> quarter of 2007.) Due to the underdeveloped financial market, the largest share in total assets of funds lies in debt securities, 39,18%, and shares, 23,65%. ( www.nbs.rs., Data from the Sector of voluntary pension funds in Serbia – Report from 3<sup>rd</sup> quarter of 2007.) By adopting the decision on the maximum amount of investment into voluntary pension funds, investments of funds have been directed into shares that are in listing A of the Belgrade Stock Market. It is allowed to invest up to 40% of total assets of the fund. In foreign currency (in terms of Euros), at the end of third quarter of 2007, there were 1,1 billion dinars of the assets of funds (mostly in old savings bonds), and about 1,5 billion dinars in domestic currency. (Rakonjac Antić and Kočović, 2008)

The development of the financial market is one of the preconditions of the development of voluntary pension funds system. At the moment, participants in the financial market, as we have previously stated, mostly place their assets in old savings bonds in foreign currency, and do not have enough investment possibilities in the domestic financial market. ( Rakonjac Antić and Kočović, 2008)

When we talk about the influence of pension funds on the financial system of Serbia, as well as the placement of liquid money assets of pension funds, we must seek to achieve profit at least equal to the average interest rate obtained on the capital market. Placement of financial assets of these funds moves in three directions:

1. purchasing real estate or immediate granting of mortgages and other loans,
2. purchasing securities,
3. depositing funds at banks and other financial organizations. ( Shepard, 1987)

When placing free financial assets, the pension fund must meet two basic principles: 1. ensure a high level of protection against the risk of its insured persons, 2. achieve the highest possible returns on invested assets. (Blake, 1995).

### **Instead of a conclusion**

A well defined system of pension insurance is of extreme importance to the development of each country, as well as to the social security of its population. The main objective of pension funds is the improvement of living standards of every individual in the community at his or her old age, when his or her abilities to earn money are little, and needs are still large. In our country, as in many countries of SE Europe, there is a serious crisis in the system of functioning of the pension insurance system, that can be rectified only through radical reforming of this extremely important system in the Republic of Serbia. (Richard, 2000). The system of voluntary pension funds in our country is at the beginning of its development and is complementary to the system of mandatory pension insurance. Efforts have been made, which should lead to the main goal of voluntary pension insurance, which is to increase the amount of pension compensations of the participants. On the other hand, there are severe problems in the economy, i.e. many companies do not work or work under difficult circumstances, so therefore there are problems in paying salaries and fees for pension insurance. All these circumstances make it difficult for pension funds to take a greater role in the entire financial sector of Serbia. By analyzing the experiences from other SE Europe countries, ( Le quiller Francais., „Accounting for implicit pension liabilities“, Lesons from the OECD, Wor shop, Paris, 2004) there is an important place within our future reformed system of pension and social insurance that should belong to voluntary insurance. Voluntary pension funds will enable every individual to create his or her own future.

### **References**

- Arsić, M., (2010), *Javno penzijsko osiguranje*, Ekonomski fakultet, Beograd.
- Blake, D., (1995), *Pension Schemes and Pension Funds in the United Kingdom*, University press, Oxford.
- Devetaković, S., B., Jovanović Gavrilović, G. Rikalović, (2005), *Nacionalna ekonomija*, Ekonomski fakultet, Beograd.
- Everett T. A., (1999), „Pension Planong (Pension, Profit Sharing and other Deffered Compensation Plans“), Irvin/MC Grav-Hill.
- Jovanović-Gavrilović, P., (2004), *Međunarodno poslovno finansiranje*, Ekonomski fakultet, Beograd.
- Kočović, J., P. Šulejić, (2006), *Osiguranje*, CID, Ekonomski fakultet, Beograd.
- Le quiller Francais., „Accounting for implicit pension liabilities“, Lesons from the OECD, Wor shop, Paris, 2004.
- Lutovac, D. M., (2009), „Rashodi za obrazovanje i zdravstvo u državama EU i Republici Srbiji“, u *Međunarodna politika*, br. 1133, januar-mart 2009., Institut za međunarodnu politiku i privredu u Beogradu, Beograd.
- Lutovac, D. M., (2006), „Penzijsko osiguranje u Srbiji i Crnoj Gori“, u *Škola biznisa* br. 3/1, decembar 2006., Visoka poslovna škola, Novi Sad.
- Pitić, G., G. Petković, D. Erić, D. Šoškić, M. Štimac, (1996), *Berzanski pojmovnik*, Beogradska berza, Beograd.
- Rakonjac Antić, T., (2004), *Dobrovoljno penzijsko osiguranje*, Ekonomski fakultet, Beograd.
- Rakonjac Antić, T., J. Kočović, (2008), „Značaj osiguravajućih kompanija i penzijskih fondova kao institucionalnih investitora“, u *Ekonomska politika i privredni razvoj*, Ekonomski fakultet, Beograd.
- Richard, D., (2000), “Crises in public pension programs in OECD: What are the reform options”, *The Economic Journal*, February 2000.
- Shepard, A. G., (1987), *Pension fund investment*, Woodhead-Faulkner, Cambridge.
- [www.nbs.rs](http://www.nbs.rs)



# COLLECTION MANAGEMENT AS CRUCIAL PART OF CREDIT RISK MANAGEMENT IN SERBIAN BANKING SECTOR

Lidija Barjaktarović<sup>1</sup>

Dejan Ječmenica<sup>2</sup>

Ana Vjetrov<sup>3</sup>

**Abstract:** *Collection management is one of the major areas of contemporary Serbian banking. It is both interesting and demanding for creditor and debtor. Non-performing loans (NPL) of the Serbian banking sector represents 16.9% of the total loan portfolio i.e. RSD 342.70 billion. If we analyze the structure of NPL we can notice that NPL corporate segment represents 72% of NPL (it is in accordance with the total portfolio structure), NPL retail segment represents 14%, and NPL other 13%. It was the basis for further analyzing the credit collection situation in Serbian banking sector.*

*Collection management has impact on the profitability of the bank and equity, through the price of the product, cost of reservation and deducted item of the equity. Also, it is important to emphasize that the collection management represents the mirror of the overall credit policy of the bank. It is not the product of well-determined input parameters of risk and credit standards, but also it is the mirror of the internal functioning of different divisions involved in the credit process. Therefore, we can say that the successful collection management is the equivalent to the total credit business – from the moment of opening the credit file until closing of the credit file, and represents the value of the bank and its credit portfolio on the market.*

*The paper points to the complexity of the collection management, and presents results of implemented model for the collection for corporate loans.*

**Keywords:** *collection management, credit risk, NPL, LGD, specific provisioning, banking sector*

## Introduction

Collection management is the process of planning, organizing, control and monitoring of credit customers of the banks with the purpose to collect credit receivables. Also, it includes all activities within the bank and in relation with the customer in order to execute efficiently collection of its credit receivables. Furthermore, the bank should be aware that only partnership and close relationship with the customer can build healthy portfolio without delay and problems in collection of due debts (Barjaktarovic et. al, 2011).

Thus, collection management presents the complex part of credit process involving different organizational parts of the bank and employees with different competence. Moreover, it is important to achieve synergy in their interaction and cooperation. Also, it is important to emphasize that successful collection management depends both on proper monitoring of external factors and information.

---

<sup>1</sup> FEFA, University Singidunum, Belgrade

<sup>2</sup> Wiener Staditsche a.d.o. Belgrade

<sup>3</sup> FEFA, University Singidunum, Belgrade, avjetrov@fefa.edu.rs

## **COLLECTION MANAGEMENT AS CRUCIAL PART OF CREDIT RISK MANAGEMENT IN SERBIAN BANKING SECTOR**

---

In accordance with Basel II<sup>4</sup> credit portfolio of the bank consists of: 1) Performing loans - PL (live credits which are not declared due and payable or it is the credit where principal amount and interest in repayment do not have delays longer than 90 days) and 2) Non-Performing Loan – NPL (loans which are declared due and payable or the credit is not in the accordance with the credit contract terms and conditions) (Grieser et al, 2009).

The most important benefits related to successful collection management are: 1) increase of the banks' profitability through usage of the reservation or through other incomes, 2) decrease of effects of new NPL and improvement in the portfolio quality, 3) impacts on the main risk parameters: LDG (Loss Given Default), SRC (Standard Risk Cost) and RAP (Risk Adjusted Price).

The most important influence of collection management is the decrease of reservation (which can be booked in the profit and loss account or on the position of the equity) which has impact on increase of profitability or decrease the equity. In the case of the group of customers which have defined level of the reservation on their group level, collection management has small impact because the level of their reservation is low. But in the case of the small banks or the banks which are not the part of any group, the level of reservation in relation with the gross level of receivables is relatively high (30%, 50%, 70%,...), the successful collection management releases that part of the cost in the profit and loss account or in the equity (Vasilski, 2010).

On the other hand, controlled increase of NPL portfolio is one of the most important tasks which bank has during the year. This task has become very demanding, especially with the appearance of the world economic crisis, because in case of many banks their credit portfolios had stagnation or decreased trend, while NPL had natural growth. At the same time the economic crisis had impact on NPL growth, which resulted in increase of portion of NPL in the total credit portfolio (Barjaktarovic, et.al, 2011).

Before the crisis NPL share in overall credit portfolio in Serbia was within 3% and 5%, however, now it is between 10% and 15%, and in some banks up to 20% (at the end of last quartile of 2011 in accordance with the data of National bank of Serbia). Consequently, in order to increase the volume, additional exposure is obligatory but limited, because it is impossible to cover the costs of the existing portfolio (Konjikusic, et.al, 2011).

In order to improve the quality and profitability of credit portfolio, we propose collection model for corporate loans (on the basis of analysis of current credit portfolio data in Erste bank Serbia). This model has had practical use in Erste bank Serbia since October 2010. The first year of usage, this model gave positive results for the bank – increased volume of approved loans, higher profit, higher level of reservations and higher equity. However, the real benefit will be seen in years to come.

### **Collection management impact on credit portfolio of the bank and its importance for credit risk management as whole**

Collection management has direct impact on the bank's profitability through the cost of reservation. Cost of reservation is the result of bank's assessment related to the part of credit portfolio that will not be collected in the future. It means that the bank will book this reservation in the future as loss in financial reports. So the estimation of the level of reservation, especially for the NPL part of portfolio is crucial for the bank. On this way, risk management division manages the total pull of reservations which considers as relevant to cover future loss of credit portfolio.

---

<sup>4</sup> Relevant regulation for banking risk management is determined by the Basel Rules. Also, important regulation for collection management is local regulation of each country connected to the performing business of legal entities, process of liquidation or bankruptcy of the company and laws connected to the collaterals (mortgages, pledge, etc.).

According to Vasilski (2011) calculation of individual change of value represents the total effect of the executed collection from the core business of the customer or by selling the collateral or by bankruptcy of the company in the following period, by using net present value with effective interest rate as discounting factor. Estimated non-collected part of the principal amount represents a particular change of the value. Total expected value of the collection has two sources: core business of the company (cash flow 1 – CF1) and collaterals or bankruptcy of the company (cash flow 2 – CF2).

Nevertheless, core business represents additional assessment of creditworthiness of the customer. Bank on the basis of current company's situation and projections of company's business makes decision in which period the company will be able to serve the commitments toward the bank and how long it will last. It is evident that this assessment is specific and more restrictive comparing to the initial approval of the loan. The new analysis has following crucial questions: 1) Is the management capable to manage the company? 2) Is the company blocked by other creditors in the amount which is hardly achievable for the debtor? 3) Does the company have the market and in which way is the position changed? 4) Are the financial projections minimally on break-even point? 5) What are the structure and the value of the collateral? Having analysed those questions, the bank is in the position to estimate the perspective of the business and possibilities of credit repayment. New restructuring of the credit commitments can be executed through official or silent restructuring. Both ways related to restructuring are being monitored on monthly basis. If the customer does not have delay in repayment, we can say that the restructuring is successful.

Moreover, collaterals or bankruptcy represents assessment of collection of receivables on the basis of collaterals which bank has on disposal (mortgages, pledges, and contracts on goods or receivables). Estimation of cash flow is based on the bank's expectation related to time and price under which the collateral will be sold in the future. The bank uses a conservative approach for collection of receivables.

Consequently, the bank chooses the model providing adequate estimation related to two segments of collection from collateral: amount and term. Further sub-criteria of the model allow better estimation of the value of the collateral such as: quality, the level of regional development, the level of market development and collateral conditions. We can say that the estimation of the collection of receivable from bankruptcy and core business, through the restructuring of the loan or through the restructuring of whole business is subject of individual assessment and, thus, provides certain obstacles for further quantification.

At the end, sum of present value concerning expected collection from core business (CF1) and present value of expected collection from the collateral or bankruptcy (CF2) represents the value which bank expects to collect on the basis of maturity receivables. Furthermore, different form in comparison to the value of total receivables is reservations i.e. individual change of the value of particular credit.

### **The collection management model within the credit risk management**

Credit risk presents the probability that the bank will not be able to collect total receivables from the customers, i.e. principal amount and all connected interest rates and fees. Having in mind the cause of the credit transaction there are 3 types of credit risk: 1) default risk (exists at the moment of loan approval), 2) premium credit risk (exists at the moment of usage of the loan and has impact on problems in repayment of the loan) and 3) risk of the worthiness of the credit rating (exists in the moment of the loan repayment). It is important to emphasize that the credit risk can be monitored in the banking book (critical threat on the credit portfolio which has impact on the banks' liquidity) and trading book of the bank.

## **COLLECTION MANAGEMENT AS CRUCIAL PART OF CREDIT RISK MANAGEMENT IN SERBIAN BANKING SECTOR**

---

The bank is successful if it fulfils the following criteria: 1) volume of newly approved loans and increase of the credit portfolio in accordance with the defined targets, 2) profitability of the bank, and 3) the level of non-performing loans. Therefore, we may conclude that the successful collection management is one of the most important tasks for the bank.

According to Barjaktarovic, et. al (2011) collection management model should cover the following areas: 1) aims of the model, 2) organization of the model, 3) instruments of the model, 4) control and monitoring within the model (PL and NPL).

### ***Aims of the collection management model***

The basic aims related to collection management of the bank's credit portfolio are: 1) regular servicing of the credit commitments of the customers, 2) minimizing the delay in servicing the credit commitments toward the bank, 3) minimizing the number of NPL in credit portfolio.

Moreover, the advanced aims related to collection management of bank credit portfolio are: 1) synchronizing additional costs on problematic loans with collection management of receivables of problematical customers, in order to have the lowest volatility of the costs on profit and loss account; 2) predicting the potential problems and future allocation of the costs. Advanced collection management means that the costs of one year grow progressively, from 0 to the defined value for particular year. Furthermore, only by using the constant cost it is possible to predict more precisely the total result of the bank. However, the volatility of those costs is not desirable.

### ***Organization of the collection management model***

The organization of the model includes: 1) classification of the debtors in the model, 2) participants and their tasks within the model.

There is a wide range of criteria for dividing the credit customers of the portfolio, such as: exposure, industry, maturity, rating of the customer, diversification in accordance with the delay basket (in the practice: delay up to 30 days, delays between 30 and 60 days, delays between 60 and 90 days and delays above 90 days), (Basel Committee on Banking Supervision, 2006). Consequently, banks try through credit policy to define aims which represents the optimal diversification of the portfolio, including own needs, market parameters and regulation frame.

In the context of collection management there are two critical determinants related to the portfolio quality and diversification: 1) rating of the customer (represents the probability that the customer will not fulfil commitment on due date. The rating of the customer consists of two parameters: quantitative and qualitative criteria (Barjaktarovic, 2009). Having defined rating of the customer, it is essential to say that there are two important groups of customers within the portfolio: liquid and non-liquid customers, i.e. PL and NPL) and 2) delay in fulfilling the commitments toward the bank (i.e. delay basket). In the end, for final segmentation of the customer in the portfolio, expert opinion is relevant (based on individual assessment of risk management division of the bank). The main subjects in creditor-debtor relation are creditors (banks) and debtors (companies).

Banks are the most important players on the financial markets. Central banks through business banks execute monetary and credit policy. In terms of collection management and assessment of credit risk within the bank the following divisions are relevant: corporate division, risk management division (corporate credit risk management, collateral management and collection management), credit committee, legal division and back office (credit administration), (Gilson et al, 2010). It is important that they work jointly. All of above mentioned divisions and departments have precise instructions for executing a loan application. Corporate division is important in daily cooperation with the customer, but also at the time of approving and monitoring the loan. Good communication and partnership relation is essential in collection management process. Risk management division is responsible for

individual credit risk assessment in the following segments: initial crediting, collection management and collateral management. Main tasks related to risk management division are: 1) restructuring: business renewal or refinancing, monitoring of the problematic loans, watch lists, stress renewal or refinancing, 2) liquidation: collection from the bankruptcy, collection from the collateral, sale of business, sale of receivables, 3) reporting and analysis: delay reports, work-out reports, provisioning management, help in budgeting process.

Moreover, debtor (company) represents a crucial part of the collection management. At the same time the company is the heart of the financial restructuring. The reasons why the company can have the problems in repayment of the loan may be various, thus hardening the whole process of their initial identification. Some of the causes of the problem can be: 1) management (35%), market – competition (30%), financials (20%) and other (15%).<sup>5</sup> It is evident that the management is the most responsible for the new problematic situation. When entering the restructuring process, the change of the management can be a very hard and painful issue for the shareholders of the company. If the results of analysis clearly point out the problem, it means that this unpopular measure should be implemented as soon as possible.

Furthermore, it should be stressed out that in Serbia, in many cases, the owners of the companies are at the same time the managers of the company. Consequently, it is very difficult to talk with the owners and persuade them that they are bad managers.

Banks are usually the biggest creditors of the company (Barjaktarovic and Jecmenica, 2010). It should be noted that the approval of the loan is the main business of the bank, comparing to the other creditors of the company. So, when the company is facing the financial problems banks should be ready to take proactive approach in solving the new situation. It means that the bank will: 1) start negotiation with other banks creditors of the same company (or group of connected companies) and 2) take action toward the company.

#### *Architecture of the collection management model*

There is no successful model without clear instruction. Organization of the process is the pillar and basis of further development and improvement of this process. Organization of the model is established on bilateral basis between the creditors (bank) and debtors (companies). But also, it should be established widely, including the market and current regulation. Important parts of organization are collection management process for PL portfolio and NPL portfolio.

Collection management of PL portfolio consists of two areas: 1) processes and actions within the bank which has final action toward the client (internally oriented), 2) processes and actions toward the client (externally oriented). Those processes are in the function to present bank's position and attitude toward the credit customer. The first process within the bank is fluctuation, but the second process should be always consistent and linear (it should be standardized; defined by the procedures of the bank adopted by the supervisory body).

Collection management of NPL portfolio is very difficult to standardized. In the practice, there are a huge number of the credit files which have discrepancy and its solutions are not directly connected with the standards. The possible ways for solving the problem are: 1) moratorium (subject of analysis and discussing the strategy), 2) implementation of the adopted decision in terms of collection of receivables from the core business of the company (restructuring, refinancing, restructuring of the business, etc.), 3) implementation of the decision that the collection will be done from collection of collateral.

---

<sup>5</sup> This statistic represents a specificity of the Serbian market (based on the experience of risk management divisions of Serbian banks). Source: Bibliography 15.

## **COLLECTION MANAGEMENT AS CRUCIAL PART OF CREDIT RISK MANAGEMENT IN SERBIAN BANKING SECTOR**

---

### ***Instruments of the collection management model***

The moment of the loan approval is crucial for making a final decision about the possible way of collecting the receivable. At the time of analyzing and approving the loan, the bank considers two possibilities for credit repayment: 1) source of repayment can be cash flow from regular (core) business, i.e. primary source of repayment (CF1) and 2) source of repayment can be collateral of the loan i.e. secondary source of repayment (CF2).

As it is already stated core business is the main source of income and possibility for repayment of the loan. When granting the loan, banks put the main focus on the core business, i.e. estimation whether the regular activity of the company will be enough to cover the commitments. The credit criteria are defined by credit policy of the bank. Common parts of those standards are: 1) general requirements (minimal qualitative criteria, additional qualitative preconditions, minimal quantitative criteria, prohibit type of transactions), 2) financial requirements in accordance with the segmentation of the customers (turnover – t/o is criteria for segmentation and the type of financing, for example project financing has different criteria), such as: rating (which determine the ratios which follows; for better ranked credit customers, lower ratios are required), ratio ST debt toward t/o (10%-40%), collateral coverage (min 20%, ratio equity toward LT debt (60-100%), ratio collateral toward total exposure (20%-75%) (Caouette, et.al, 1998). Cash covered loans (including bank's guarantee issued by the first rank bank), overdrafts and loans with low risk are excluded from those criteria.<sup>6</sup>

The financial criteria should be revised in case of problematic situation, i.e. at the moment of difficulties in repayment of the matured obligations. The most important tasks of collection management are to synchronize the new situation with the customer's business. This is the approach which makes the biggest benefit for the creditor and debtor. At the moment of restructuring of the loan initially defined financial standards are decreasing, up to break-even margin. Under this level, business restructuring does not make sense. Also, it should be stressed that any business restructuring is not good restructuring. Thus, it is necessary, before any restructuring, to answer the question whether we as a creditor believe in this business? Before we answer this question, we should provide a detailed and serious analysis.

The bank uses collateral, as secondary source of repayment of the loan, when the core business of the company stopped. All instruments which bank use as secondary security can be classified as follows: mortgages, pledge, corporate guarantees, assignment of receivables, and other collaterals. The crucial thing is to determine the proper value at the time of approving the loan, and to reconsider the value of the collateral at the moment of collecting the receivables.

### ***Control and monitoring within the collection management model***

PL and NPL clients are subject of control and monitoring within the collection management model. It means that it should be recognizable when PL customer has problems in repayment and which proactive measures the bank will take toward the customer in order to avoid delay. Moreover, the model identifies in NPL portfolio which problems may appear and which analysis should be done in order to minimize the negative effect related to new problems in appearing.

As we have already mentioned, the model consists of two analyses: quantitative analysis and qualitative analysis. Quantitative analysis represents changes which already appeared in customer's business and may affect the regular repayment of the loan and core business of the customer. All early warning signs can be categorized as follows (big changes in customer's behaviour, market data, problems in daily business and signs of fraud).

---

<sup>6</sup> The conclusion on the basis of the experience of Serbian banks in the previous period. Source: Bibliography 15.

Qualitative analysis represents a portfolio analysis on the basis of historical data. Historical data can be internal (internal data base) and external (market data). Internal indicators are: days of delay, rating, industry and t/o through the account within the bank. External indicators are: blockade of the account, financial data (t/o, gross profit margin, EBIT, net profit, total assets, equity, short term loans, long term loans, receivables, payables, inventories).

Consequently, on the basis of quantitative and qualitative criteria, all credit customers of the bank are divided in 3 zones in accordance with the risk level: 1) red zone – the most risky customers of the portfolio, 2) yellow zone – the zone of medium risk, 3) green zone – zone of the low risk. After implementing appropriate analyses, corporate credit risk manager sends information to the responsible account manager which customers are potentially problematic in the future in order to organize the meeting with such customers and prepare proper strategy for the customers i.e. collection of the receivables. Practically, it means preparing of review application. Generally, the risk management division monitors credit portfolio on permanent basis, but if they estimate that it is necessary, they can monitor the credit risk related to particular customer i.e. loan.

### Results of implemented the collection management model

Erste bank started operations in Serbia in 2005. They acquired Novosadska bank a.d. Novi Sad. The process of transformation was finished at the beginning of 2007. Moreover, Erste bank implemented the collection management model in the second part of 2010. Financial results of Erste bank a.d. Novi Sad during 2011 (available on their site) had positive trend i.e. implemented collection management model has positive result on overall result of the bank (table 1; figures 1 and 2). Also, NPL information is not presented in official financial results of Erste bank a.d. Novi Sad. It is important to say that one year period is not enough for making final conclusion. Consequently, we will continue to investigate the results of implemented model in years to come.

**Table 1: Financial results of Erste bank a.d. Novi Sad (in mil RSD)**

Year	2007	2008	2009	2010	2011
Credits in use	12312	9359	6051	7538	13641
Net profit	174	334	391	318	789
Equity	10215	10538	10931	11259	12051
Shareholder equity	12279	10175	10164	10164	10164
Reservations (from profit)	471	/	344	736	1054
Revalorization reservations	23	15	20	24	26
Profit/loss to the equity level	(2,087)	347	407	318	810
Net costs on the basis of indirect loans and reservations	260	739	611	738	883

Source: *Erstebank (2012) Financial Key Figures* [[www.erstebank.rs/en/About\\_us/Financial\\_Key\\_Figures;jsessionid=9w2zP4fGMfgJHpL42H2n23wsJTqwSvMLZVG6k0tnWJrnm22qnTcq!345117063](http://www.erstebank.rs/en/About_us/Financial_Key_Figures;jsessionid=9w2zP4fGMfgJHpL42H2n23wsJTqwSvMLZVG6k0tnWJrnm22qnTcq!345117063)]

In 2007 credit activity of Erste bank a.d. Novi Sad was on good track. However, in 2008 there were less approved credits due to the world economic crisis, and implemented restrictive credit policy (Jelenkovic and Barjaktarovic, 2011). Consequently, at the end of 2008 Austrian banks in Serbia established a restrictive credit policy (known as traffic light) toward corporate segment: 1) red light (decrease of exposure toward defined segment, without new approvals): construction, production and sale of cars, energetic, textile industry, processing industry and tourism; 2) yellow light (increased

## COLLECTION MANAGEMENT AS CRUCIAL PART OF CREDIT RISK MANAGEMENT IN SERBIAN BANKING SECTOR

watch): furniture industry and exporters of fruits and vegetables; 3) green light (standard cooperation): telecommunication, IT and media, agriculture, pharmaceuticals, processing and sale of food and beverages, transport, services, municipalities and public sector. If we compare this with the current NPL we can notice that this restrictive credit policy was the appropriate choice.

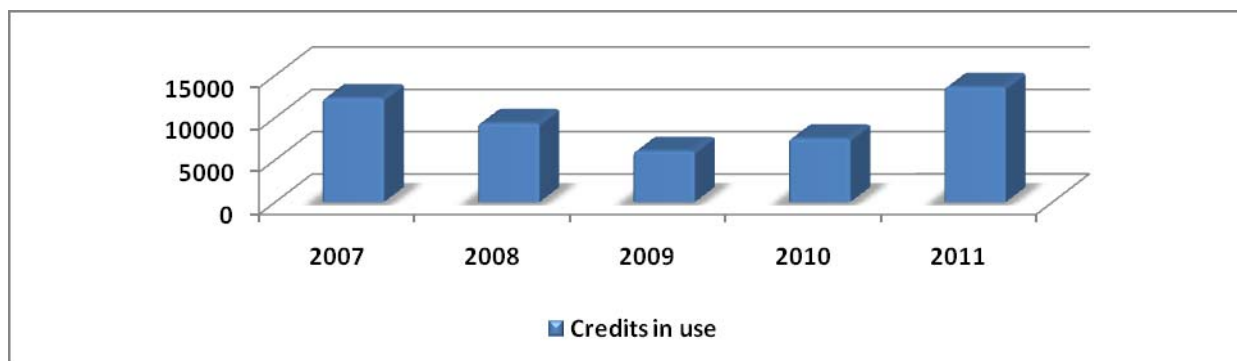

**Figure 1: Volume of credit activity of Erste bank a.d. Novi Sad (in mil RSD)**

Source: *Erstebank (2012) Financial Key Figures* [[www.erstebank.rs/en/About\\_us/Financial\\_Key\\_Figures;jsessionid=9w2zP4fGMfgJHpL42H2n23wsJTqwSvMLZVG6k0tnWJrm22qnTcq!345117063](http://www.erstebank.rs/en/About_us/Financial_Key_Figures;jsessionid=9w2zP4fGMfgJHpL42H2n23wsJTqwSvMLZVG6k0tnWJrm22qnTcq!345117063)]

Moreover, the decreasing trend of credit activity was continued in 2009 as well as and slow increasing movements started in 2010, while the pick of credit activity was achieved in 2011 (it is in line with total banking sector starting from 2009). It should be noticed that implemented collection management model helped bank to approve new healthy loans, but also to recognize the possible problems in repayment of the loan before the due date. Also, it should be noticed that the profit had increasing trend (better results are achieved in comparison to the whole banking sector). Finally, net profit and reservations of the profit were constantly growing, and their volume is higher in comparison to net costs on the basis of indirect loans and reservations.

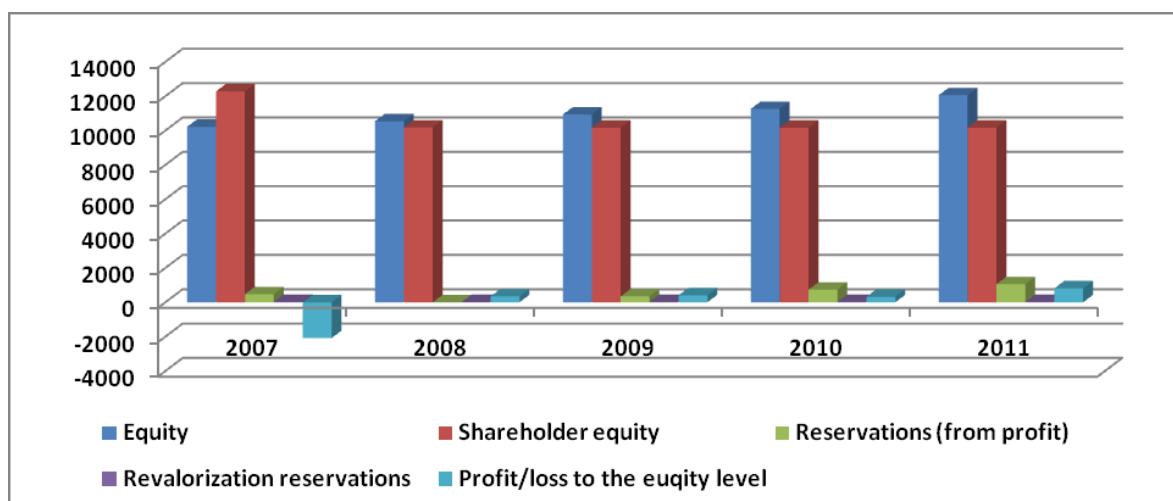

**Figure 2: Fluctuations of equity and its components of Erste bank a.d. Novi Sad in the period of 2007 to 2011 (in mil RSD)**

Source: *Erstebank (2012) Financial Key Figures* [[www.erstebank.rs/en/About\\_us/Financial\\_Key\\_Figures;jsessionid=9w2zP4fGMfgJHpL42H2n23wsJTqwSvMLZVG6k0tnWJrm22qnTcq!345117063](http://www.erstebank.rs/en/About_us/Financial_Key_Figures;jsessionid=9w2zP4fGMfgJHpL42H2n23wsJTqwSvMLZVG6k0tnWJrm22qnTcq!345117063)]



Equity had increasing trend (it is in the line with total banking sector), so we can concluded that there were no losses in credit business covered by the equity. Shareholder equity was on sustainable level. Net profit and reservations from profit had increasing trend. It should be the message that the bank has healthy credit portfolio. It means that implemented credit model helped bank to grow with good quality of assets and appropriate level of reservations.

### Non-performing loans in Serbia

The Serbian banking sector recorded growth of credits, NPL, equity and reserves in previous period. However, the profit was on the lowest level at the end of 2011 (RSD 1.25 billion). At the end of 2011 credit portfolio achieved level of RSD 1.671.9 billion and NPL reached the level of RSD 342.70 billion (table 2 and figure 3). Moreover, it should be noticed that the level of reservation is not in accordance with the level of NPL.

**Table 2: Key financial figures of Serbian banking sector (in bill RSD)**

Years	2007	2008	2009	2010	2011
<b>NPL</b>	44.21	71.42	201.60	273.50	342.70
<b>Credits</b>	760.90	1027.60	1278.30	1534.90	1671.90
<b>Equity</b>	328.50	419.90	447.50	498.00	545.90
<b>Reserves</b>	47.60	74.30	104.50	130.30	150.20
<b>Profit</b>	23.47	34.95	20.03	25.40	1.25

Source: NBS (2011), Banking Sector - Quarter and Annual Report [  
[http://www.nbs.rs/internet/english/55/55\\_4/index.html](http://www.nbs.rs/internet/english/55/55_4/index.html)]

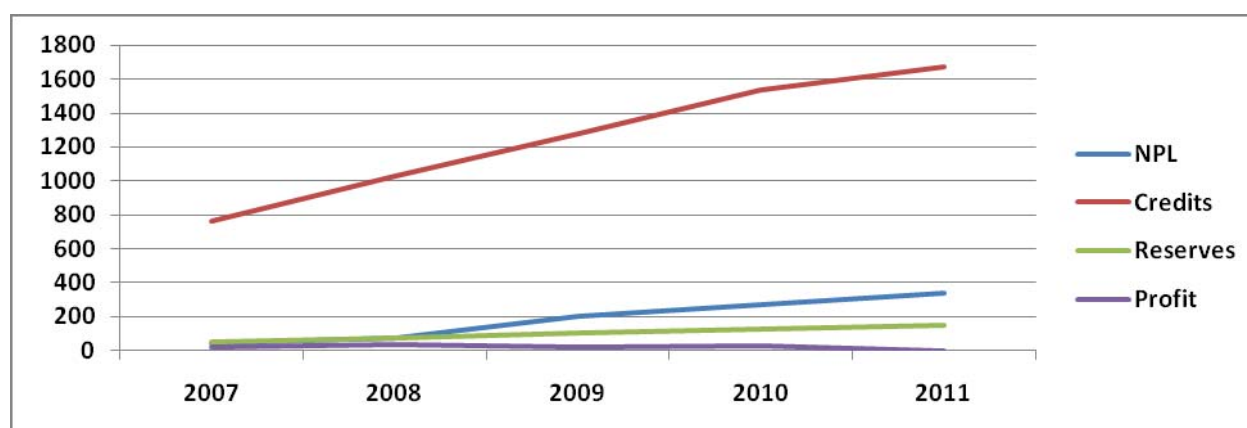
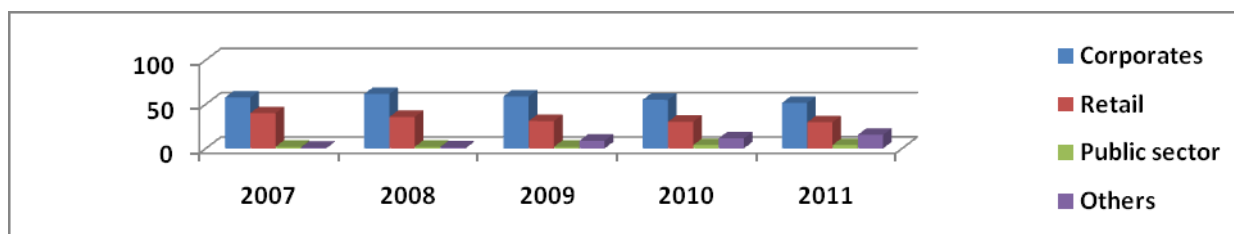

**Figure 3: Key financial figures of Serbian banking sector (in bill RSD)**

Source: NBS (2011), Banking Sector - Quarter and Annual Report [  
[http://www.nbs.rs/internet/english/55/55\\_4/index.html](http://www.nbs.rs/internet/english/55/55_4/index.html)]

## COLLECTION MANAGEMENT AS CRUCIAL PART OF CREDIT RISK MANAGEMENT IN SERBIAN BANKING SECTOR

The majority of portfolio represents corporate segment (51.3%), then retail segment (29.5%), public sector (3.8%), and other (15.4%). The most problematic issue is growth of the exposure toward the public sector in the previous period (figure 4), because it means increase of consumption, problem of repayment for young generation and possible crowding out effect.



**Figure 4: Structure of Serbian banking credit portfolio in the period of 2007-2011 (in bill RSD)**

Source: NBS (2011), *Banking Sector - Quarter and Annual Report* [  
[http://www.nbs.rs/internet/english/55/55\\_4/index.html](http://www.nbs.rs/internet/english/55/55_4/index.html)]

Non-performing loans (NPL) of the Serbian banking sector represents 20.5% of the total loan portfolio i.e. RSD 342.70 billion. NPL related to loans granted to entrepreneurs and corporate has the biggest share in overall NPL (figure 5).

**Table 3: Structure of Serbian banking sector NPL (in %)**

Years	2008	2009	2010	2011
Financial sector	0.36	9.31	12.2	7.6
Public sector	1.14	0.08	0.3	0.9
Sector of other entities	7.11	11.8	21.8	24.6
Entrepreneurs sector	2.79	9.05	21.1	25.1
Public sector	0.61	1.43	0.9	1.5
Retail Sector	3.81	4.08	7.9	7.9
Non-resident sector	2.75	2.77	8	8.1
Households sector	5.72	7.86	14.9	13.7
Sector of other customers of the bank	2.07	13.07	12.9	10.6

Source: NBS (2011), *Banking Sector - Quarter and Annual Report* [  
[http://www.nbs.rs/internet/english/55/55\\_4/index.html](http://www.nbs.rs/internet/english/55/55_4/index.html)]

Having in mind the importance of corporate segment for the growth of one economy we will continue to analyse the structure of NPL corporate segment (figure 6). Manufacturing industry represents 34% of NPL corporate segment, 28% trade, 13% real estate, 12% construction, 8% agriculture, 5% transport, 0% education, electricity and others. Consequently, this structure of NPL is in accordance with implemented restrictive credit policy (Jelenkovic and Barjaktarovic, 2011).

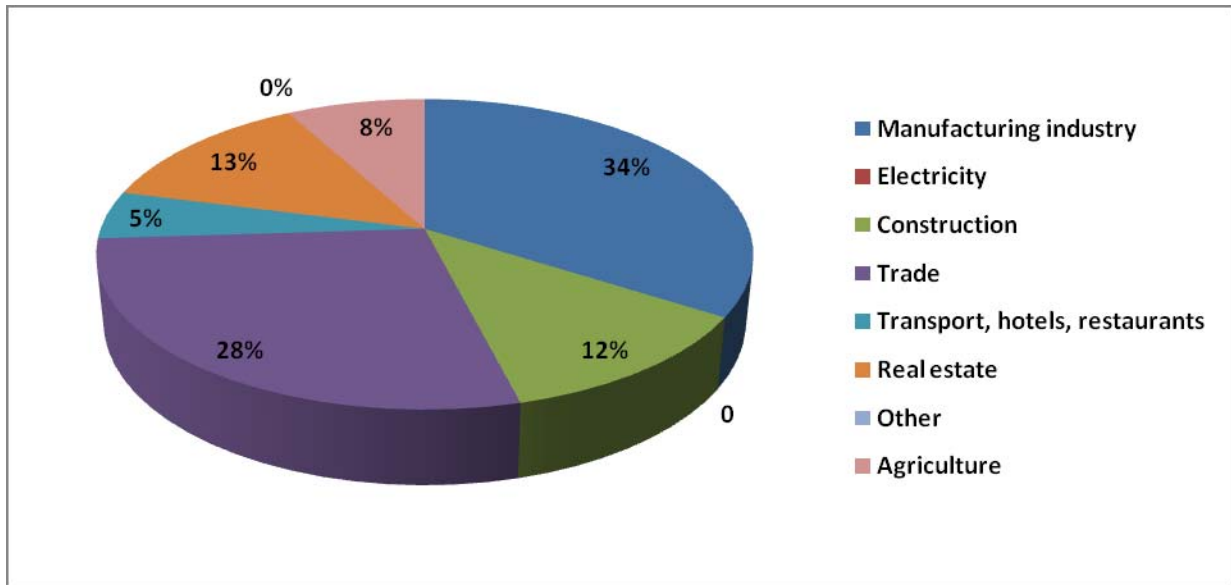

Figure 6.

### Summary

Collection management has impact on the profitability of the bank and equity, through the price of the product, cost of reservation and deducted item of the equity. The economic crisis, which had impact on the financial and real sector as well stressed the importance of the collection management and necessary changes of collection management model. The collection management of credit receivables is possible in two ways: 1) restructuring (credit or business) and 2) selling the collaterals. These two ways should be considered and implemented during the entire credit life cycle (not only after 90 days of delay in fulfilling credit obligations). Overall and proactive approach is necessary for the successful collection management. The proposed collection management model is aimed to predict problems in repayment of the loans which currently do not present an issue. The idea is to stop further growth of NPL and to improve the quality of the existing credit portfolio. Architecture of the model covers all credit customers – PL and NPL. The proceses in the model are divided in the following way (from the perspective of the creditor – bank): 1) process and actions within the bank which have impact on the approach toward the customer, 2) processes and actions toward the customers. Those processes send proper message to the customer regarding the strategy toward it.

The analysis showed that there is room for further improvement of the collection management within Serbian banking sector. Also, it is evident that this process is both complex and important part of the credit risk management process in the bank. The model helps the bank to establish adequate collection management process and relation between the bank and debtor (company). Collection management has a big impact on the level of reservation – general and specific provisioning. The adequate assesment of collection and successful collection of receivables are the guarantee for reliable and precise quality of own reservations, which have impact on the profit and loss account of the bank and the equity. The assesment of specific provisioning is especially important, having in mind their impact on the total pool of reservation. At the end it is important to emphasize that the collection

## COLLECTION MANAGEMENT AS CRUCIAL PART OF CREDIT RISK MANAGEMENT IN SERBIAN BANKING SECTOR

---

management represents the mirror of the overall credit policy of the bank. It is not the product of well-determined input parameters of risk and credit standards, but also it is the mirror of the internal functioning of different divisions involved in the credit process. Therefore, we can say that the successful collection management is the equivalent to the total credit business – from the moment of opening the credit file until closing of the credit file, and represents the value of the bank and its credit portfolio on the market.

Finally, financial results of local bank which implemented the collection management model are better than the results of overall banking sector. However, it is important to say that one year period is not enough for making final conclusion. Consequently, we will continue to investigate results of implemented model in the following period.

### Acknowledgments

This Research Paper was the part of the project “Improvement of Serbian competitiveness in the process of entering to European Union”, no. 47028, in the period 2011-2015, financed by Serbian Ministry of science and technological development.

### References

- Barjaktarovic, L. (2009). *Risk management*, University of Singidunum, Belgrade.
- Barjaktarovic, L., Jecmenica, D. (2010) *Impact of competitiveness on Serbian banking sector*, The book of proceedings How to increase the competitiveness of Serbian economy and export, The Serbian Academy of Economic Sciences and The Faculty of Economics, Kragujevac
- Barjaktarovic, L., Jecmenica, D. (2011) *Optimism vs. pessimism of competitiveness of Serbian banking sector*, *Industrija* 2/2011, Belgrade.
- Barjaktarovic L., Popovic-Avric, S., Djenic, M. (2011) *Collection management of Serbian banking sector during the crisis*, *Finansije* 1-6/2011, Belgrade.
- Basel Committee on Banking Supervision (2001). *The Internal Ratings- Based Approach – Supporting Document to the new Basel Capital Accord*, (available at [www.bis.org](http://www.bis.org)).
- Basel Committee on Banking Supervision, Internal Convergence of Capital Measurement and Capital Standards (2006), A Revised Framework Comprehensive Version, Bank for International Settlements, Basel, (available at <http://www.bis.org>).
- Caouette, J., Altman, E., Narayanan, P. (1998). *Managing Credit Risk – The Next Great Financial Challenge*, Wiley.
- Committee of European Banking Supervision (CEBS): <http://www.c-ebs.org> / [available data on June 2012]
- Gilson, S. C. (Author), Altman, E. I. (Foreword) (2010). *Creating Value through Corporate Restructuring: Case Studies in Bankruptcies, Buyouts, and Breakups*, Wiley.
- Grieser, S., Wulfken, J. (2009). *Performing and Non-Performing Loans across the World: a Practical Guide*, Euro money Institutional Investor.
- Jelenkovic, Z., Barjaktarovic, L. (2011) *Cross border loans during the crisis*, The book of proceedings 7th International Conference of ASECU, Rostov University of Economics
- Konjikusic, S., Barjaktarovic, L. and Radojevic, G. (2011) *The methodology for calculating the probability of default*, *Trziste kapitala* novac 3/2011, Belgrade.
- National bank of Serbia: <http://www.nbs.rs/kontrolaposlovanjabanaka> [available data on June 2012]

Reports of Erste bank a.d. Novi Sad (2011) Erste bank a.d. Novi Sad: [http://www.erstebank.rs/rs/O\\_nama/Izvestaji](http://www.erstebank.rs/rs/O_nama/Izvestaji) [available data on June 2012]

Vasilski, A. (2010). *Collection management from the borrower's perspective during the world's economic crisis*, The Faculty of Economics, Finance and Administration, Belgrade.



# EUROPEAN QUALIFICATIONS FRAMEWORK: EXPERIENCES FROM SEVERAL EUROPEAN BANK TRAINING NETWORK (EBTN) MEMBERS

Sladjana Sredojević<sup>1</sup>

**Abstract:** *European Qualifications Framework (EQF) allows individuals and employees easier and more efficient use of their qualifications and realistic comparison of qualifications in different countries and educational systems, enabling greater mobility for experts and improving exchange of knowledge and experience. It also encourages recognition of both formal and informal education, which can be particularly valuable for persons employed in specific sectors of the economy. By analyzing examples of EQF implementation in different countries, it can be concluded that carrying out of this very useful European Commission recommendation can be a quite complicated task. The goal of this paper is to analyze the results of the empirical study on experiences of EBTN members from Italy, Portugal, Holland and Poland regarding different approaches and achievements in both individual and EBTN assisted EQF implementation.*

**Keywords:** *qualifications, European Qualifications Framework, European projects, lifelong learning, financial services sector.*

## Introduction

European Banking and Financial Services Training Association Aisbl - EBTN, with its head office in Brussels, is a non-profit network of institutes and centres dedicated to education of banking sector employees. It has 26 full members and 10 associate members. Through European projects EBTN works on standardization of procedures for knowledge, skill and competence accreditation, certification and qualification in the European financial services sector. The Association of Serbian Banks (ASB) has been a full member since 2008 and from that time has been involved in EBTN management through a representative in its Board of Directors. Through their work on European projects regarding continual professional development and lifelong learning process in general, EBTN assists its members in understanding and implementing European Qualifications Framework.

The motivation for the analysis in this paper lies in the membership of the Association of Serbian Banks in the EBTN which enables direct sharing of knowledge, experiences and best practices in the EQF implementation and long life learning in the financial services sector. The aim of this empirical research is to disclose the extent of complexity in EQF implementation in financial services sector in different countries, from one side, and from another - to analyze whether the EBTN projects and network used in the process of EQF implementation facilitated the process in those countries or not. Using the case study method, analyses have been conducted of experience of the EBTN itself, as well as of banking institutes from following countries: Italy, Poland, Netherlands, Portugal.

Therefore, the paper is structured in two parts. First part is covering Sections I-III and has a theoretical tone mapping the EQF and EBTN as strategic coordinates of the study. First Section is giving brief overview of the EQF and its importance. Second Section is describing the mission and activities of EBTN and its contribution in EQF implementation through EBTN and European projects. The future projects in EBTN agenda will be dedicated to further EQF implementation, facilitating its members through jointly undertaken projects, which is described in the Third Section.

---

<sup>1</sup> Association of Serbian Banks, Belgrade, [sladjana.sredojevic@gmail.com](mailto:sladjana.sredojevic@gmail.com); [sladjana.sredojevic@ubs-asb.com](mailto:sladjana.sredojevic@ubs-asb.com)

The Second Part of the paper, covering sections IV-VII, is dedicated to Case studies – analysis of the experience with EQF implementation in selected banking institutes i.e. members of EBTN: the Fourth Section is analyzing the case of ABI Formazione in Italy, the Fifth Section – case of EQF implementation at the Warsaw Institute of Banking in Poland, The Sixth section - Dutch Institute for Banking Insurance and Investment's experience with EQF and eventually the Seventh Section is analyzing experiences of the Portuguese Bank Training Institute with EQF.

**The last part of the paper is Conclusion.**

Since the study is empirical, its results could be used for further improvement of training, education and employment policy for professionals in Serbian banking sector. Last but not least, students (economic science, organizational science, etc) as future employees in financial services sector represent very important stakeholder who can also benefit through validation of acquired knowledge, skills and qualifications, and through gaining an increased level of mobility both in and outside a particular country or market.

**First part: EQF and EBTN as strategic coordinates of the study**

**The importance of EQF**

The European Qualifications Framework (EQF) is a common European reference framework which links countries' qualifications systems together, acting as a translation device to make qualifications more readable and understandable across different countries and systems in Europe. It has two principal aims: to promote citizens' mobility between countries and to facilitate their lifelong learning. EQF is a meta-framework or a tool for comparison of different qualifications gained in different systems (Komnenović et al. 2010). The Recommendation formally entered into force in April 2008. It sets 2010 as the recommended target date for countries to relate their national qualifications systems to the EQF, and 2012 for countries to ensure that individual qualification certificates bear a reference to the appropriate EQF level (European Commission, 2008). This means that, from 2012, all issued qualifications must have a direct reference to a specific EQF level. The goal of the EQF is to allow individuals and employees easier and more efficient use of their qualifications and facilitate realistic comparison of qualifications in different countries and educational systems, enabling greater mobility for experts and improving exchange of knowledge and experience. Qualification is defined as a formal outcome of an assessment and validation process which is obtained when a competent body determines that an individual has achieved learning outcomes to given standards. Although it was agreed upon in 2008, the implementation of EQF recommendation into the national qualification systems was not intensified until 2012.

EQF specifications and goals are:

- 8 set qualification levels (not training, job description or individual levels),
- introduces categories of knowledge, skill and competence,
- uses processes of valuation and validation,
- encompasses both formal and informal knowledge and
- insists on the importance of national authorities.



In general, “the majority of EU member countries aim for comprehensive frameworks covering all levels and types of qualifications and seeking a stronger integration between them. This is a significant result as it shows an increased attention to the overall coherence and permeability of education and training systems and their ability to promote lifelong and life wide learning” (European Centre for the Development of Vocational Training – CEDEFOP, 2010). By analyzing experiences in EQF implementation from several EBTN members (from Italy, Portugal, Holland and Poland), it can be concluded that carrying out of this very useful European Commission recommendation can be a quite complicated task.

### **EBTN and the European Qualifications Framework**

The goal of EBTN is to become an organization that sets standards for accreditation, certification and qualification of knowledge, skills and competence in the European financial services sector. EBTN aims to create professional education standards in Europe and enrich the professional European culture and enhance European as well as international relations and alliances. Also, aim is to form accreditation structure where EBTN verifies accreditations through qualifications, diplomas and certificates issued by individual EBTN members and other financial sector institutions in Europe.

The objectives of EBTN are:

- To promote the ethical, professional and technical development of employees and a high quality approach to education, training and qualifications;
- To develop and promote common European frameworks and standards for education, training and qualifications;
- To liaise with EU authorities and other competent authorities and organizations involved in the European financial services sector.
- To develop and implement a common European system for accreditation, validation, certification and quality assurance of education, training and qualifications;
- To create added value for members and facilitate the sharing of good practice related to education, training and qualifications;

As one of the methods in meeting these objectives, EBTN has extensive experience in implementing European projects. These projects are implemented not only to service the needs of EBTN members and financial markets they represent, but also to further numerous EU goals, recommendations and policies regarding continual professional development and lifelong learning process in general. These are the following projects:

#### ***A) In the area of accreditation and certification***

1. EFCB – European Foundation Certificate in Banking (2003-2004). The European Foundation Certificate in Banking is based on a Standard Examination Model (SEM) as the quality model of the European Foundation Certificate in Banking. Bank employees who have passed a qualifying examination can obtain the EFCB. The EFCB certificate can only be delivered by an Accredited Institute. Accreditation takes place through the Accreditation and Certification Committee of EBTN. The main objective of the Accreditation and Certification Committee is to assure the quality of the examination.
2. CERTIFIED – Certification and Accreditation System for Financial Services Sector Education and Training (2006/2008). The aim of CERTIFIED was the creation of a new system for the certification of competences and the accreditation of training providers in the EU Financial Services Sector.

3. QUADULTRAINERS – Towards a European Qualification Prototype for Adult Trainers (2008/2010). The aim of the Quadultrainers Project was to increase the recognition, the social prestige and the attractiveness of the adults trainers profession by proposing - through a multi-stakeholder research and consensus-building process - a European Qualification Prototype for adult trainers.

***B) In the area of lifelong learning process***

4. FIRST – Financial Services EQF Translator in EU (2010-2011). The aim of the Financial Services EQF Translators in EU (FIRST) was to promote the application of the European Qualifications Framework (EQF) as a valuable reference to redesign and create a modern competence-based qualifications infrastructure for the Financial Services Sector in the EU.
5. BIF – Banking and Insurance and Financial Network – Promoting Recognition of Learning Outcomes through ECVET system (2009-2011). The aim of the Banking & Insurance & Financial Network (BIF) was to promote the application of ECVET (European Credit system for Vocational Education and Training) to the training provision in the Banking, Insurance and Financial Services Sector, so as to prepare the ground and create realistic opportunities to apply the ECVET in the BIF sector that employs more than 6 million people in Europe.
6. QUALOBSTERS – Quality Assurance in Learning Organization in Banking and Financial Sector in Europe, (2007-2009). The aim of the Quality Assurance in Learning Organisation in the Banking Sector in Europe (QUA.LOBSTER) Project was to improve the quality of training provision in the Financial Services Sector, combining the existing benchmarking approach and tool for the Learning Organisation (Leonardo Da Vinci Network "LOBSTER") with Quality Assurance principles and methods.

***V) In the area of interaction between real sector and higher education institutions***

7. EUROBANQA – European banking network for quality assurance (2007-2008). The aim of the European Banking Network for Quality Assurance (EUR.BA.N.QU.A.) was to apply the European Common Quality Assurance Framework (CQAF) to the Banking and Financial Services Sector in Europe by linking this model with current developments and challenges towards the improvement of training provision in the sector.
6. EFEP – European Financial Education Partnership (2010 – 2012). The aim of the European Financial Education Partnership is to benefit pupils and teachers and the broader social and economic society as a whole, through the provision of financial education workshops in schools, delivered by professionals of the Financial Services and other sectors.

The nature of these projects and member cooperation resulted in a longstanding close and productive collaboration between EBTN and EU institutions (primarily European Commission) charged with implementation of training, development and lifelong learning policies.

**Future steps of EBTN regarding EQF**

EBTN, as an organization dedicated to accreditation, implementation of standards and propagation of positive experiences between its members through an organized method (European projects), intends to realize a new set of projects. Thus, future steps would be focused on combining several segments or different projects in order to directly contribute to the further implementation EQF: provision of practical guidelines, recommendations regarding the concrete implementation of

the Lifelong Learning provisions in the Financial Services Sector, instruments/tools, templates, concrete cases. The core objective is to take all existing modern EU qualification related tools and recommendations and to turn them into one integrated model which is both aspirational and feasible for wider application. EBTN wants EQF, ECVET and EQAVET to be known, understood and widely used in Financial Services Sector. This will facilitate mutual and official recognition of qualifications/certificates issued by members and allow the allocation of an appropriate number of ECVET points and EQF level. In order to receive this kind of treatment; individual certificates must fulfill certain criteria, such as:

- Qualification is relevant in the financial services sector of the job market;
- Qualification is sufficiently extensive (ECVET point minimum, see BIF project);
- Qualification is described in the context of the learning outcome (EQF, see FIRST project);
- Independent agency must perform the qualification evaluation procedure;
- Service provider (banking institute) is compliant with European quality assurance guidelines (EQAVET).
- CPD (Continuing Personal or Professional Development), as a lifelong personal and professional development process is a part of this project.

All EBTN members are encouraged to participate in this project. Network and synergy of exchange of experience of various European banking institutes and training centers, as EBTN members, will put together best practices from the world of VET and the world of work.

## **Second Part: Case Studies**

### **EQF experiences in ABI Formazione in Italy**

ABI Formazione is the training division of ABISERVIZI S.p.A., a service company fully owned by the Italian Banking Association (ABI). Its staff composed of 30 people and an external network of about 300 financial professionals and leading consultants. ABI Formazione is the main E-Learning Services provider in the Italian banking system. Its mission is to be the leading company in the field of training and professional services for the Italian financial services industry; and to excel in offering innovative and efficient training services to the banking sector (EBTN et al. 2009).

ABI Formazione charged with professional training in the Italian financial services market, presented results of the "Qualifications in the European Financial Services Sector" study. This study was conducted in the first half of 2012 by ABI Formazione, and its goal was to review national qualifications frameworks (NQF) in all EBTN members, as well as to review qualifications (on the basis of the information gained from questionnaires), particularly in the financial services sector. The main conclusions of the study were: development of NQF in many of the EU member states is not complete and qualifications development in the financial services sector is conducted at an even slower pace (D'Angelo and Maisano, 2012). There are also many difficulties in interpreting and understanding the relations between EQF and NQF: the level of knowledge regarding EQF is very low, especially in some particular industries, including the financial services sector. The study shows that Scotland and Holland have had most success in implementing EQF in the financial services sector. Difficulties in the EQF implementation are numerous: differences in education and training in various countries are significant, which makes the common path difficult to identify. Would qualifications in all countries be adequately positioned at the appropriate EQF levels in the absence of coordinated activities? The consequence of the absence of coordinated activities could have adverse effects on EQF implementation due to individual approach to implementation and lack of trust in other

qualifications systems. Therefore, coordination is still necessary, but the possibility that EQF could be regarded as an issue related to job market agenda rather than a matter of educational system should be considered. In most countries the qualifications formation process is handled by the public sector: social partners and training providers are included only in a consulting capacity.

### **Experience with EQF at the Warsaw Institute of Banking in Poland**

The Warsaw Institute of Banking - WIB is a non-profit foundation which works for financial institutions and their clients. The goal of the organization is to develop and increase the effectiveness of the financial services market in Poland. The Institute, well established in the banking sector, offers its expertise in the field of banking, finance and management. WIB's team consists of over 150 highly qualified specialists from various fields. They are banking and financial experts, university professors, trainers and organizers. In the last 10 years, WIB has been involved in certification and accreditation programmes both locally and internationally. It is one of the founding authors of the System of Standard Qualifications in Polish Banking. The Institute has extensive experience in working with international partners and within international projects, in cooperation with EBTN and the European Commission. That includes EU projects within Leonardo da Vinci, Minerva and Socrates programmes (EBTN et al. 2009).

WIB has been, for years, quite successful in implementation of various projects in the financial services sector. One of these projects is the FIRST project which facilitated implementation of EQF into the Polish banking market and Polish institutions in general. Representing the source of EQF Translator in Financial Services Sector, the objective of FIRST project was to capture the relevant language and features of the business processes and performance criteria in financial services sector to be able to translate the EQF general levels' descriptors in a more meaningful way for the Financial Services Sector.

The goal of this project was to promote EQF as a useful foundation for the formation of a modern qualifications framework in EU's financial services sector based on competences.

Important points gathered from WIB's experiences with this project are:

- A tailor-made version of EQF descriptors better reflect the work environment of Financial Services Sector and the language of the sector.
- It makes easier interpretation of EQF and the allocation of EQF levels to Financial Services Sector qualifications
- It enables familiar and user friendly reference framework for the Financial Services Sector community.
- it is important to fulfill basic prerequisites such as agreement on the meaning of fundamental terms. So the first task was to define the term "qualification": "Qualification means a formal outcome of an assessment and validation process which is obtained when a competent body determines that an individual has achieved learning outcomes to given standards" (Szymanska-Koszczyk, 2012).
- Also, specifications and goals of EQF were defined: it has 8 set qualification levels and not training, job description or individual levels, it introduces categories of knowledge, skill and competence, it uses processes of valuation and validation, it encompasses both formal and informal knowledge and insists on the importance of national authorities. These are only some of the important EQF specifications, and according to the experiences of our Polish colleagues, it is very important to take the time to understand the terminology which is, when it comes to EQF, quite intricate and complex.

Thanks to the FIRST project, this institute was found it easier to understand EQF requirements and to assign some EQF levels to specific qualifications in the financial services sector for levels 3-7<sup>2</sup> in the following business processes: banking for small and mid-size businesses, compliance, savings and investment.

**Figure 1. Qualifications within EQF**

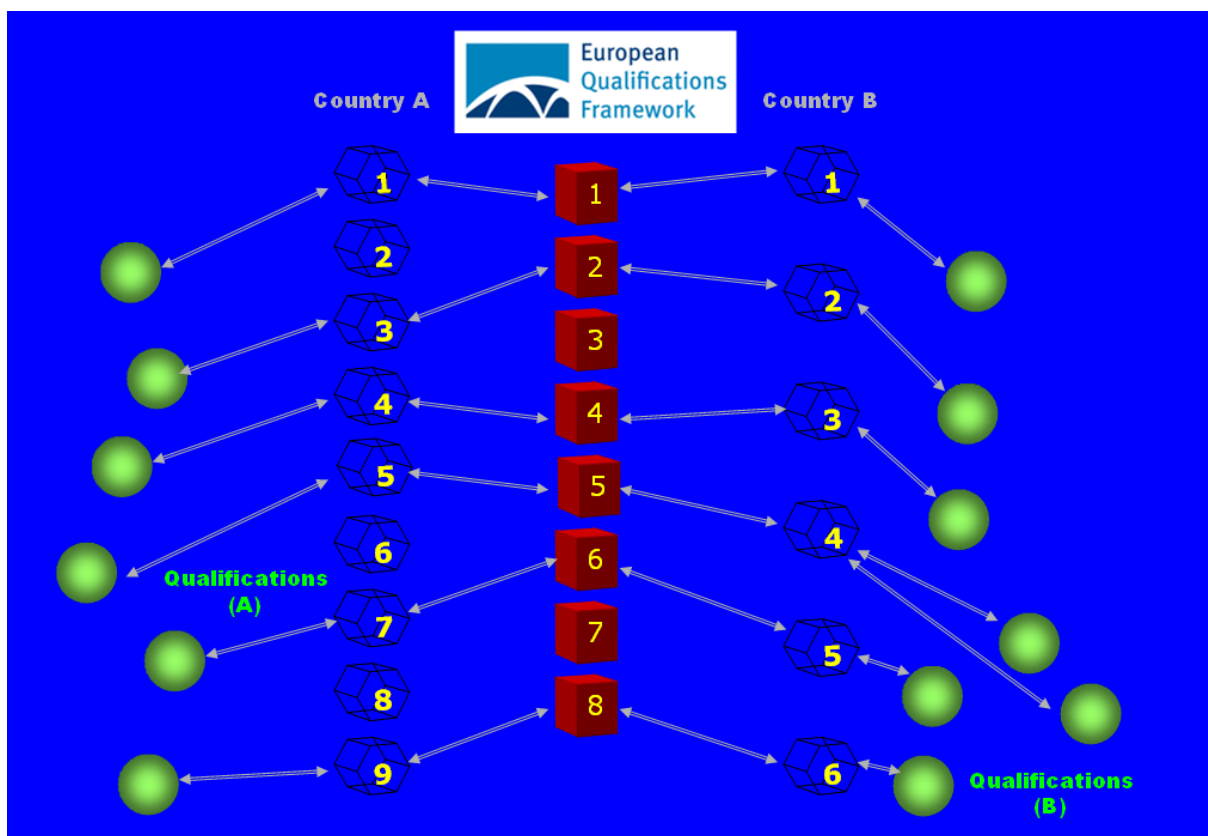

Source: presentation of Ms. Mariola Szymanska-Koszczyk, Vice-president Warsaw Institute of Banking, at the EBTN member meeting, Athens, 12/10/2012

### **Dutch Institute for Banking Insurance and Investment's experience with EQF – NIBE-SVV experiences**

NIBE-SVV is the leading education and training facilitator for the financial institutions in Netherlands. The organization services more than 40.000 students a year within training and educational programmes on different levels and wide range of subjects (EBTN et al. 2009).

Experiences of the Dutch Institute for Banking Insurance and Investment (NIBE-SVV) with EQF were predominantly aimed at modification and adaptation of EQF descriptors as well as on defining 1) knowledge, 2) skills (knowledge application, problem solving, learning, development and communication), 3) competences (autonomy and independence regarding work and learning). Some qualifications in Netherlands are government regulated and some are not. Government regulated

<sup>2</sup> EQF levels

qualifications are automatically entered into the qualifications register maintained by national coordination agency<sup>3</sup>, while other qualifications can be entered only after this agency evaluates them and assign a proper EQF level. The procedures for this process are strictly and clearly defined which represents very important factor for successful EQF implementation (Spooneberg, 2012).

### **Experiences of the Portuguese Bank Training Institute with EQF**

The Portuguese Bank Training Institute IFB, together with its the Portuguese School of Bank Management (ISGB), was created and is owned by the Portuguese Bank Association (APB) and is responsible for training and specialized higher education. Its mission is to strengthen the culture of the banking profession and foster the development of the Portuguese financial sector by improving the qualifications of its human resources (EBTN et al. 2009). IFB is officially certified by Institute for Training and Quality Certification, a state owned body for quality certification of training institutions.

The Portuguese Bank Training Institute IFB had a very positive experience with the ECVET project in the financial services sector (BIF Project – Banking & Insurance & Financial Sector). European Credit System for Vocational Education and Training (ECVET) is directly tied to other European systems and other existing mechanisms for professional development such as: EQF, Europass, EQAVET. Through this project, the Portuguese banking sector facilitated the lifelong learning process, promoted certification and supported recognition of learning outcomes (Vilhena da Cunha, 2012).

### **Conclusion**

The nature of European projects and EBTN member cooperation resulted in a longstanding close and productive collaboration between EBTN and EU institutions (primarily European commission) charged with implementation of training, development and lifelong learning policies. EBTN has extensive experience in implementing European projects. These projects are implemented not only to service the needs of EBTN members and financial markets they represent, but also to further numerous EU goals, recommendations and policies regarding continual professional development and lifelong learning process in general. By analyzing experiences in project implementation which affirm and support EQF adoption in the financial services sector of several EBTN members (from Italy, Portugal, Holland and Poland), it can be concluded that carrying out of this very useful European Commission recommendation can be a quite complicated task. EQF adoption into the national frameworks represents the challenge for a country, having in mind the following requirements:

- Continuous participation of various and numerous stakeholders,
- Decision makers' awareness of EQF and NQF necessity and its long time horizon,
- Awareness among the labor market and education sector participants of the necessity to rely on each other, in order to support common goal: knowledge based and developed economy;
- Existence of clear common goals in education that are focused rather on results than on the inputs.

However, **positive effects far outweigh difficulties**. By analyzing examples of EQF implementation in financial services sector in EBTN itself as well as in banking institutes from Italy, Poland, Holland and Portugal, it can be concluded that carrying out of this very useful European

---

<sup>3</sup> National Coordination Point (NCP): Independent Body

Commission recommendation **represents a quite complicated task**. It is evidenced that different approaches and achievements are introduced in order to facilitate EQF implementation in the financial services sector in EU. However, it is obvious that there are many positive experiences that are in common for all institutes: **benefit of EBTN membership and network itself** and particularly of EBTN projects (as a tool) in EQF implementation is present among all banking sectors from the sample.

Banking employees and students in financial services sector are the ones that benefit the most from them since now they can validate acquired knowledge, skills and qualifications, and gain an increased level of mobility both in and outside a particular country or market. Therefore, EBTN as a network of various banking institutes and training centers should continue to act a precious generator of these potential benefits, disseminating them through its members. In return, experiences and mutual support coming from different banking systems are ensuring the position in which EBTN can catalyze standards for accreditation, certification and qualification of knowledge, skills and competence in the European financial services sector. In that respect, Association of Serbian Banks as an EBTN member has strategically important orientation in transmitting best practices and European project to the domestic financial services sector. At the same time, Association of Serbian Banks has responsibility for further dissemination of opportunities for banking employees and banking students, further EQF implementation, as well as application of European systems and other existing mechanisms for professional development and long-life learning in the financial services sector in the Republic of Serbia.

## References

- Candy, P. C. (1991). *Self-direction for Lifelong Learning. A comprehensive guide to theory and practice*, San Francisco: Jossey-Bass.
- D'Angelo, D. and A. Maisano (2012). *ABI Formazione: Qualifications in the Financial Services Sector*. At the EBTN member meeting, Athens, 12/10/2012 hosted by Hellenic Banking Institute of the Hellenic Banking Association.
- Dal Lago, G (2012). Lifelong Learning: una crescita che dura una vita. *FB – Banca in Formazione - Finance&Banking (60/2012)*. Rome: Associazione per lo Sviluppo Organizzativo e delle Risorse Umane.
- EBTN et al. (2009). *CERTIFIED PROJECT. European Certification System based on Competences: a challenge in Financial Services Sector*. Rome: EBTN.
- EBTN online (2012). (accessed on 19/11/2012) <<http://www.ebtn-association.eu>>.
- European Centre for the Development of Vocational Training - CEDEFOP (August 2010). *WORKING PAPER No 8: The development of national qualifications frameworks in Europe*. Luxembourg: Publications Office of the European Union.
- European Commission, Education and Culture DG (2008). *The European Qualifications Framework for Life Long Learning (EQF)*. Luxembourg: Office for Official Publications of the European Communities.
- European Commission online (2012). *Lifelong Learning Policy*. (accessed on 30/5/2012) [http://ec.europa.eu/education/lifelong-learning-policy/eqf\\_en.htm](http://ec.europa.eu/education/lifelong-learning-policy/eqf_en.htm).
- Knowles, M. S. (1950). *Informal Adult Education*, New York: Association Press.
- Komnenović, B. et al. (2010). *Nacionalni okvir kvalifikacija*. Belgrade: Centre for Education Policy.
- Pantić, N., T. Wubbels, and T. Mainhard (2011). Teacher Competence as a Basis for Teacher Education: Comparing Views of Teachers and Teacher Educators in Five Western Balkan Countries. *Comparative Education Review*, 55 (2), pp. 165-188.
- Plant, P. (2012). Quality assurance and evidence in career guidance in Europe: counting what is measured or measuring what counts? *International Journal for Educational and Vocational Guidance*, Volume 12, Issues 2, pp. 91-104.

## **EUROPEAN QUALIFICATIONS FRAMEWORK: EXPERIENCES FROM SEVERAL EUROPEAN BANK TRAINING NETWORK (EBTN) MEMBERS**

---

- Smith, M. K. (2002). 'Malcolm Knowles, informal adult education, self-direction and andragogy', *the encyclopedia of informal education*, (accessed on 13/11/2012) <[www.infed.org/thinkers/et-knowl.htm](http://www.infed.org/thinkers/et-knowl.htm)>.
- Spooneberg, C. (2012). *NIBE-SVV: Dutch EQF Experiences*. Presentation by vice-president of NIBE-SVV and vice-president of EBTN at the EBTN member meeting, Athens, 12/10/2012, hosted by Hellenic Banking Institute of the Hellenic Banking Association.
- Szymanska-Koszczyk, M. (2012). *Warsaw Institute of Banking: Results of Project FIRST - A driver for joint action by EBTN members - The Case of Poland*. Presentation by vicepresident of WIB at the EBTN member meeting, Athens, 12/10/2012 hosted by Hellenic Banking Institute of the Hellenic Banking Association.
- Vilhena da Cunha, L. (2012). *ECVET in Financial Services Sector* - Presentation by IFB - The Portuguese Bank Training Institute director at the EBTN member meeting, Athens, 12/10/2012 hosted by Hellenic Banking Institute of the Hellenic Banking Association.



# GLOBALIZATION AND ITS IMPACT ON THE ECONOMIC POLICY – THE CASE OF THE REPUBLIC OF MACEDONIA

Pece Nedanovski<sup>1</sup>

Predrag Trpevski<sup>2</sup>

**Abstract:** *Globalization as a process refers mainly to the increased interdependence of the contemporary economic and social systems. Nobody has a doubt that it has its own internal forces that make this process objective and necessary, and that it increases the exposure of economies to external shocks by increasing their degree of international openness. What is very important for the policy makers is that the globalization may also reduce the level of decision making independence, since its economic conditions cannot diverge significantly from those in other countries.*

*Starting from this point of view, a relevant number of researchers claim that the globalization produces separation of the world, visible through the marginalization of the poorest countries. The critics see the world in itself as a twisted picture where the globalization is used as an excuse for promotion of liberalization and creation of common market. From here two questions could be raised:*

- *Is the globalization understood correctly, and*
- *What are the consequences from the globalization for the policy makers and for the running of economic policies?*

*The rules for running economic policies are effective and count solely under normal and predictable economic conditions. The previous is not a case when there are unpredictable economic conditions where a redesign of economic policies is required. This also refers to the economic policies in the Republic of Macedonia. The global financial crisis that began several years ago also hit Macedonia, and due to this it was necessary that monetary and fiscal policy is redesigned. The paper tries to face these questions, and to offer correct and sound answers: what is possible to make in order to protect the interests of a small and underdeveloped country, at the same time trying to extract the optimal benefit from the globalization in itself. Under such conditions, the most acceptable for Macedonia is the fiscal-monetary mix which would be defined as a tight budget policy and to a certain extent as more expansive monetary policy.*

**Keywords:** *globalization, economic policy, fiscal-monetary mix, R. of Macedonia.*

## Introduction

Comprehension of the substance of the globalization process should show how really the unconditional development right of nations is coming true in the world. If we can define the globalization as a process led and marked by technological changes, long-term growth of foreign investments, as well as the new extensive types of international relations among firms and countries, then it means there is identification of profound and intensive growth of the internationalized economic activities or profound integration and interdependence. Actually, globalization represents an “expansion on a global scale of the interrelations among national economic and social systems through private economic institutions. Such expansion is associated with the increase in international movements of goods, ‘financial’ capital and labour, and with an increase in

---

<sup>1</sup> Faculty of Economics, University of Skopje, pecen@eccf.ukim.edu.mk

<sup>2</sup> Faculty of Economics, University of Skopje

international production, mainly by multinational corporations.” (Acocella, 2005, p. 421) All these implicate a difference between ‘globalized world economy’ and ‘the internationalized world economy’.

The globalization understood as a process implicates that it will produce a new level in the world economy that might be identified as a globalized economy, meaning another level and quality of relations, functioning, institutions, changed competence and importance of the national states, too. This is quite different image of the internationalized world economy at the current level of development, although it is very often to be called global economy which fundament means necessary implementation of the principles of free trade and common (global) market with unconditional rights of the private capital and state withdrawal from the regulation of the economic flows.

The globalization can be valued through different dimensions, but the most evident is the dimension of an integrated financial system, considering the importance of the capital markets on long-term economic growth of the national economies. For this purpose, the most appropriate method is measurement of the integration level of national economies, through comparison of the rate of domestic savings and domestic investments. If there would be an integrated financial system, the domestic savings will not be a limiting factor for the domestic investments. However, in the 1980’s and 1990’s, during the period of capital flows liberalization and fluctuating foreign exchange rates, the importance of domestic savings has not been diminished. This has exemptions in two cases: underdeveloped countries with undeveloped banking system and for highly developed countries with financial system capable for speculations and speculative pressures causing instability.

### **Globalization as a complex process**

The process of globalization is very complex by its nature. The previous is expressed through its basic forms i.e. liberalizations of different markets, that lead to creation of global market.

The liberalization of market for goods, services and technology is the oldest form of entrance on the world market. The opening of the national economies is an imperative for the economic growth. Consequently, every step toward autarchy has negative impact and it is seen as an anachronism. But, the tendency for integration of the markets for goods and services as well as technology markets is contradict. Namely, tariffs are decreasing, but on the other hand non-tariff provisions are increasing, producing ‘new’ type of trade protectionism.

The complexity of globalization is shown in the most evident way through the example of the labor market. While other markets, through the liberalization, are integrating in the world market, this is not a case with the labor market – it cannot be liberalized in the same way because the free movement of this factor comes to barriers.

Labor market, actually, is eliminated from the process of liberalization because of the lack of working places in the highly developed industrial countries and because of the high unemployment, especially in the case of the workers with lower qualifications, as a result of the structural changes, the rise of productivity, decreased rate of economic growth etc. Logical consequence from these tendencies is the labor protectionism i.e. undertaking measures that block employment of foreign workers in the developed industrial countries. In opposite, there would be registered mass inflow of foreign labor force coming from less developed economies. Such inflow at first would intensify the unemployment crisis, but at the same time it would have impact on the wages and as a result would initiate social conflicts in developed countries.

Anyway, no one in this context can omit the issue of the elasticity of labor demand in the developed countries. Namely, the indirect effects manifest themselves simultaneously in the prices of goods/products. The increased supply of low-skill labor-intensive products exported from developing

countries will lower the relative price of these products, therefore lowering the relative prices of the factors of production used most intensively in making them. It is a question of unskilled labor. With this argument we can explain the increase in wage differences between skilled and unskilled labor in some developed countries. However, the most acceptable explanation for the economic theory for the last decade is that the technical progress is actually a main factor for the process of widening the wage differences.

What about the liberalization of the financial market? It is a fact that the integration of the financial market allows usage of the free money sources, first of all for economic purposes. There is nothing that can animate the global thesis so strong, as it can the idea for global integration of financial markets. Countries have been opening their economies for foreign investments, pulling down the barriers for entrance of foreign capital, even in the sphere of banking and insurance. There are national laws and the number of agreements between countries, with one purpose – reciprocally investing of capital and eliminating the problems of double taxation.

The globalization of financial markets witnesses pluses and minuses in opposite directions in the relation developed - developing countries. Some of them are consequences of the mutual connections of the economies in the world, as well as the sensitivity on economies on financial shocks, that are transferring very fast, but do not hit the developing countries so easily, because of the low level of development of their banking sector.

It can be said that the process of liberalization of the information markets, as the ‘youngest’ form of the process of liberalization, has been developing quickly. Today, the lack of information does not appear to be a problem. On the contrary, there is inflation of it, which outgrows in a real ‘information mess.’ As a logical consequence of such movements is the drastically drop of prices on the information market. In the meanwhile, on the supply side, and from the viewpoint of the consumption of information, again there is predominance of the developed countries, while the share of the rest of the countries, stands behind them. This asymmetry principally results from the lower level of technical education of the developing countries vis-à-vis developed countries. Hence, this is a fertile ground for having the problem of asymmetry of information (on an international level) become arisen and that of moral hazard and adverse selection as well.

Finally, no one can omit the fact that the process of globalization has also social aspects. These aspects appear through the increased inequality between the rich and the poor, on the international as well as national level. This polarization is a consequence on the logic of the current system – profit maximization. The globalization does not change the character of that system. Bearing in mind the previous, it is obvious that the poverty has become one of the most serious problems all around the world. Today, tremendous part of the world population, is forced to search the source for their existence in the gray economy (non-formal sector), or even in the crime and prostitution – phenomena that are result of a globalization tendencies, but at the same time represent a brake for the globalization as a process.

The asymmetry of the globalization trends will be present long time in the future, so long that it is ungratefully to make prognoses. This is because between the globalization as a process and globalization as a phenomenon there is a difference. As a shaped phenomenon, the globalization is still theoretical hypothesis, but as a process it is reality which cannot be avoided, but can be faced with prepared.

### **Globalization and its influences – disputes about the process of deindustrialization**

It is well known from the theory that the globalization has a lot of consequences. Firstly, the globalization as a process produces changes in the rules of the game that is played by different actors. Consequently, the previous change will give different outcomes for all actors (players), even for those

## **GLOBALIZATION AND ITS IMPACT ON THE ECONOMIC POLICY – THE CASE OF THE REPUBLIC OF MACEDONIA**

---

who stick with their unchanged strategies. For instance, “even if the globalization and Europeanization of the economy does not lead to a ‘race to the bottom’ of national welfare states, demands for a modernization of the national labor market and social security regimes are increasing.” (Heidenreich and Bischoff, 2008, p. 498)

According to the economic literature, all economic phenomena should be assessed in terms of efficiency and equity, in a static and dynamic context. From this point of view, the impact of globalization provides more efficiency on a large (world) scale, primarily as an increase in the economic growth. Namely, the globalization increases specialization, world trade and capital movement (FDI). The increased specialization induces companies to exploit economies of scale more effectively. Actually, “firms are not looking for low costs, but for high levels of productivity and market stability. This is especially true in capital-intensive industries.” (Fligstein and Merand, 2002, p. 8) Now, with a help of this, the costs are reduced, and the world economy’s potential for growth has been increased.

Many economists see the increased specialization as a tool for the process of falling in manufacturing’s share of employment i.e. the process of deindustrialization. These processes were recorded firstly in the developed countries since the 1970s. The theory has attributed this process of deindustrialization to the globalization of markets for goods and services. “The rise in developing countries’ exports of manufactures due to the autonomous growth of certain of these countries and the simultaneous shifting of part of manufacturing by the developed countries to the developing world through direct investment or subcontracting and other similar arrangements could explain the (relative) loss of employment in manufacturing in the industrial world.” (Acocella, 2005, p. 430)

Bearing in mind the previous, the process of deindustrialization can be additionally explained by the demand itself and by technological factors. Namely, one can see the decreased share of manufacturing employment as a consequence of the higher income elasticity of demand for services. Actually, parallel to the increased income, the demand for services would rise even more than the demand for goods. From the point of view of the technology, it is well known that productivity goes up slowly for services than for the production of goods. Consequently, the increased demand for services needs bigger proportion of increases in employment than greater demand in industry. Obviously, this situation will diminish the manufacturing’s employment proportion in the total employment.

So far, a number of economic researches have not succeeded to find solid arguments for resolving the debate between those who argue that deindustrialization is caused by globalization and for the opponents who attribute the process of deindustrialization to the demand and technology. Despite this, the dominant view is that process of deindustrialization should be seen as a normal feature of the growth. This is the case especially for advanced countries. The rise of the unemployment rate in developed countries was partly caused by the adjustment difficulties. “Many economists have argued that globalization has interacted with technological developments to increase levels of unemployment in the economically advanced countries. The assumption here is that technological developments in these economies have escalated educational job requirements to levels where the less educated no longer are qualified” (Korpi, 2003, p. 603) The situation was even worsened by the competition from the developing countries, but this had a marginal role in deindustrialization. Actually, it is not the main cause of the rise in unemployment in the developed countries for the last 1-2 decades, but in the near future, these processes could include bigger participation of the developing countries.

No economist can deny the fact that globalization has got significant influence on the division of benefits and costs among countries, and the distribution of benefits and costs within each country, as for instance between skilled and unskilled workers. In this sense, it is obvious that the growth in trade and international capital movements has actually marginalized some less developed countries (as we explained earlier). Probably the reason with strongest influence in this direction is

the elimination of tariff barriers by some developing countries with a role of protecting their vulnerable domestic industries. Regarding the case of individual countries, the globalization produces benefits and costs that are not distributed in uniform way. This is a result of the influence of globalization on competitiveness.

### **The economic policies from the point of view of the globalization**

Starting from its nature, it is easy to understand that the process of globalization increases the degree of international openness of the national economies, exposing them to external shocks. “Globalization is not a single process, but a set of processes whereby firms and nations around the world are interacting under different dynamics.” (Fligstein and Merand, 2002, p. 21) Actually, for the last 2-3 decades all national economies and the world as a whole had started being more and more interdependent. Speaking in economic terms, it means that a problem or decline in economic activity in one country (or countries), sooner or later (in a short or mid-term) will be transmitted to the other national economies. This is easily understandable because of the international ties between the national economies at present.

Having in mind the previous, one can expect that the globalization reduces the independence of the process of decision making in a country. Namely, the economic conditions in a globalized world do not diverge from one economy to another. Also, inevitable is the fact that under current conditions, there is no such a policy that has only domestic effects. Consequently, from here comes an additional reduction in national policymakers’ independence because the policymakers cannot omit this fact, acting completely isolated from the rest of the world. “The national political process has to adjust firmly to decision-making rhythms and detailed calendars of supranational processes of decision-making and negotiation.” (Jernecek, 2000, 39, as cited in Goetz, 2009, 214) Finally, today countries and national economies are exposed at the global market thus being open for positive or negative consequences coming from the economic policies in other countries. “When countries in economic crises decrease their imports, export possibilities in other countries decline and their unemployment problems mount, thereby likely creating a situation that pressures governments to make cuts in social-insurance and –service programs.” (Korpi, 2003, p. 603) This kind of consequences are relevant not only for the public, but for the private agents as well.

In general, each national government faces constraints in the short term on its freedom to expand demand or to adopt structural policy measures that increase the short-term costs of agents located in that country, even if such measures could produce positive effects in the long term (Acocella, 2005, p. 435).

It is not so difficult to find the answer to the question -“Who is a transmitter of these impacts?” Normally, it is the financial market(s). Through the financial market(s) the impact of shocks that arise in one national economy and the effects of the policy that the policymaker had an intention to conduct, could be transferred to the agents in other national economies. Even more, the financial market can ‘help’ accelerating the reaction of agents in the ‘guest’ national economy. Of course, with a help of this transmission mechanism the financial market(s) has an essential role in the formation of expectations. Now it is understandable why, “national governments face pressures to adjust national regulations in an effort to make them more attractive to mobile capital.” (Wallace H., Wallace W., Pollack A. M., 2005, p. 41)

### **Macedonian fiscal-monetary mix**

National economies, in contemporary stage of the globalization cannot just stay out of its movement. They should actively participate in it i.e. to become equal subject in the movements of

globalization. This result from the fact that globalization should not be left only to the market, because it has its own intrinsic as well as acquired defects. Up to the rounding off the process of globalization, the role of the national economies must be concentration on creating favorable macroeconomic environment for intensifying the growth of the domestic economy on the one side, and for strengthening of its positions on the other side. In this context national economies should keep their legal, organizational and control issues not in a way of eliminating the market, but to canalize in desired direction.

The first symptoms of the large world financial and economic crisis in Macedonia were felt almost one year after its appearance. Although the crisis initially appeared in the middle of year 2007, first in USA and then in the rest of the developed countries, the first manifestations in Macedonia appeared in the second half of year 2008 i.e. after the NATO Summit in Bucharest and after the early parliamentary elections, and they started to hot up in year 2009 as well. This imposed the need to think once more about redesigning the policies of aggregate demand managing i.e. the need to redesign the monetary and fiscal policy.

The increase in consumption and the enhanced investing activity, in 2008 caused a strong trend of aggregate demand growth. The growth in aggregate demand happened in its three components: the (personal) consumption, the investments and the government's (budgetary) expenditures. This was accompanied by a decrease in the interest rates and the easier access to bank loans. When it comes to the formation of the expectations regarding the economic movements in the period that follows, which resulted in having greater spending and increase in aggregate demand, it is certain that the Government policy had its influence, and on the basis of this policy the public was trying to convince itself 'that the crisis will not hit Macedonia and that it will pass the country by, and at the end Macedonia could even ends up as winner.' It is certain that this hit up the expectations and became one of the factors that accelerated the trend of aggregate demand growth.

The pressures on the aggregate demand that resulted in increasing the general level of prices, where inflation had its growth rate being the highest one in the post-stabilization period, required that macroeconomic policies are redesigned. With regard to this, we would again accentuate the standpoint of the New Keynesians about the ways the economic policies could be run, the standpoint being the one that the changes in the economic circumstances require changes in economic policies and therefore it is impossible to previously determine which policies would be the most appropriate ones (see more in Mankiw 1994, p. 335-336 and Stiglitz 1993, p. 1069). Due to this, the rules for running economic policies are effective only under normal and predictable economic circumstances, whereas in case if unpredictable economic circumstances they need to be redesigned. This refers to the economic policies in Macedonia. The crisis that hit the country required that the monetary and fiscal policy were redesigned.

Under circumstances of running a strategy of fixed rate of exchange, the new ambience required changes in monetary policy in the direction of stabilizing the growing inflation and the inflation expectations as well as maintaining the rate of exchange. For the purpose of this Macedonian Central Bank (NBRM) in the first half of year 2008 implemented two measures: first, in February NBRM went from "tender with interest rates" to treasury bills auctioning according to the principle "tender with amounts" (unlimited amount and fixed interest rate), and in the first half of the year the interest rate increased three times; second, on 12 June 2008, NBRM adopted a Decision for compulsory deposit, in case their increase in the credits for the population overcomes the projected growth rates. These measures on the side of aggregate demand, accompanied by stabilization of the price of food and oil, in the second half of year 2008, contributed that the inflation and inflation expectations stabilized.

Aggregate demand managing through discrete fiscal and monetary policies is basically profiled for a short-term notice. Meanwhile, what should be considered are the following moments:

- The effects of the monetary and fiscal policy over the composition of output (gross domestic product) are pretty different;
- Fiscal and monetary policy while managing the aggregate demand, appear to be substitutes. The previous facts significantly influence the optimal mix of fiscal and monetary policy, which is different for different periods and conditions the economy is in; and
- Fiscal and monetary policies have long-term effects on economy.

As a result of this, the question posed is which are the determiners for conceptualizing optimal fiscal-monetary mix? When combining the monetary and fiscal policy the following should be taken into consideration: the openness and the size of economy, the phase the economic cycle is in, the level of economy development, and the time dimension within which effects of the implemented policies are going to be realized (more in Petkovski 2001, p. 234-237 and Fiti 2009, p. 188-191). Having in mind all these criteria while conceptualizing the fiscal-monetary mix, we would further refer to the optimal combination of these two policies in Macedonia.

The mix of fiscal and monetary policy led to successful stabilization of Macedonian economy in the first half of the 1990s. Aggregate demand managing was also successful in the post-disinflation period, because in that period the general level of prices was kept stable. We can be certain in our conclusion that fiscal policy was crucial in the stabilization period, which supports the fact that having a healthy fiscal position is a precondition for having stabilization. However, it is also certain that although price stability was achieved for the whole period of time, we cannot avoid the fact that economic activity showed modest signs of enlivening, investments were at a very low level and the unemployment had permanent increase. Under conditions of low rates of economic growth and huge rates of unemployment, what should be thought about, is the application of macroeconomic (stabilization) policies and their optimal combining. The key question here is whether and what kind of fiscal-monetary mix can positively influence the real factors of Macedonian economy, investments and employment.

In the case of Macedonia, the expansive fiscal policy, in short run, will lead to an increase in the real output, and in the long run it will result in an increase in the interest rate as well as in a decrease in investments, which appears to be inconvenient under circumstances of already low level of investments. The expansive fiscal policy that Macedonian Government had been implementing in the last four years, led to an increase in the interest rates and to the appearance of the crowding out effect in 2009. However, in mid-run, it can also have a positive influence if the structure of budgetary expenditures is dominated by the capital expenditures i.e. the investments in the macro infrastructure, which positively influence the civil engineering that further has positive effects on a large number of industries. Also, investments in education increase the human capital and have positive influence on economic growth (see more in Fiti 2004, p. 9-10).

Completely opposite are effects of the expansive monetary policy. Expansive monetary policy decreases the interest rates and directly influences investments, which further lead to increase in employment i.e. decrease in unemployment, in the short run. However, in the long run, the effects of monetary policy are related with the Philips curve in the long run. The real factors go back to the primary level, while having general level of prices.

Considering these conclusions, the most acceptable for Macedonia is the fiscal-monetary mix that would be defined as “a strong budgetary policy and some more expansive monetary policy.” (Fiti 2004, p. 12). Having this in mind, and on the basis of the previous conclusions about the short-term and long-term effects of monetary and fiscal policy, what is shown is that in the R. of Macedonia the fiscal-monetary mix is not optimal and does not lead towards a positive trend of the real factors. It is necessary that they are redesigned, and as a special issue appears to be the very structure of the public (budgetary) expenditures, which is pretty much inconvenient. In year 2008 capital expenditures

amounted 17.9% of the total budgetary expenditures, whereas the rest 82.1% are current expenditures in the structure of which with 65.4% dominate salaries, allowances and the social transfers. In 2009 the structure of budgetary expenditures drastically worsened. Namely, capital expenditures in 2009 decreased to 12.9% of the total budgetary expenditures for that same year, whereas the remaining 87.1% are current expenditures, in the structure of which dominate salaries and allowances for the state officers (public administration) and the social transfers that amount to 66% and remained at the same level as the previous year. In 2010 the course of the budgetary policy did not change because capital expenditures remained at a low level of 14.8% of the total budgetary expenditures, whereas in the structure of current expenditures there were no changes and it remained the same as in the previous years.

### **Conclusion**

The globalization could be defined as a complex process, which is led and marked by the technological changes, the long-term growth of foreign investments, as well as the new extensive types of international relations among firms and countries. Actually, the notion of 'globalization' means an increased interdependence of economic and social systems through the action of private institutions.

The process of globalization is very complex by its nature. This is expressed through its basic forms i.e. liberalizations of different markets, that lead to creation of global market.

The economic theory tells us that the globalization has a lot of consequences. The globalization as a process produces changes in the rules of the game played on the world market. Also, many economists see the globalization as a cause for the process of deindustrialization. Yet, so far a number of economic researches have not succeeded to find solid arguments for resolving the debate between those who argue that the deindustrialization is caused by the globalization and for the opponents who attribute the process of deindustrialization to the demand and technology.

The globalization reduces the independence of the process of decision making in a country, because the economic conditions in a globalized world do not diverge from one economy to another. Also, there is no such a policy that has only domestic effects.

Having in mind the short and long run effects of the fiscal and monetary policy, it can be concluded that the current fiscal-monetary mix in Macedonia is not an optimal one. With regard to the characteristics of the Macedonian economy, the phase of the business cycle for the moment, and the time dimension too, the most acceptable for Macedonia is the fiscal-monetary mix which would be defined as a tight budget policy and to a certain extent as more expansive monetary policy.

### **References**

- Acocella, N. (2005). *Economic Policy in the Age of Globalisation*, Cambridge University Press.
- Bache, I. (2010). Building multi-level governance in Southeast Europe? *Southeast European and Black Sea Studies*. 10/1. 111-122.
- Buelens, F. (ed) (1999). *Globalisation and the Nation-State*, Edward Elgar.
- Brada, J., and Fiti, T., (eds.) (2005). *Towards Dynamic and Sustainable Economic Growth – Growth Supportive Policies*, Blue Ribbon Commission Report for Macedonia, USAID, Skopje.
- Fiti, T. (2004). Macroeconomic stability and growth (in Macedonian), *Open challenges for the Macedonian economy*, MANU, Skopje.



- Fiti, T. (2009). *Phenomenology of the economic crisis*. (in Macedonian) Faculty of Economics, Skopje.
- Fligstein N. and Merand F. (2002). Globalization or Europeanization? Evidence on the European Economy Since 1980. *Acta Sociologica*.
- Goetz, K. (2009). How does the EU tick? Five propositions on political time. *Journal of European Public Policy*. 16/2. 202-220.
- Heidenreich M. and Bischoff G. (2008). The Open Method of Co-ordination: A Way to the Europeanization of Social and Employment Policies? *Journal of Common Market Studies*. 46/3. 497-532.
- Kemmerling, A. (2010). Does Europeanization lead to policy convergence? The role of the Single Market in shaping national tax policies. *Journal of European Public Policy*. 17:71058-1073.
- Korpi, W. (2003). Welfare-State Regress in Western Europe: Politics, Institutions, Globalization, and Europeanization. *Annual Review of Sociology*. 29. 589-609.
- Lightfoot, S. (2010). The Europeanization of International Development Policies: The Case of Central and Eastern European States. *Journal of Southeast European and Black Sea Studies*. 62/2. 329-350.
- Mankiw, G ed. (1994 a), *Monetary Policy*. Chicago: University of Chicago Press.
- Petkovski, M. (2001). Instruments of the macroeconomic policy in the R. of Macedonia (in Macedonian). *Macroeconomic policy in the field of finances*. MANU, Skopje.
- Shamid J., Wetping W. and Simin E. (eds). (2000). *Local Dynamics in the Era of Globalization*, World Bank.
- Stiglitz, J. (1993), *Economics*, New York: W. W. Norton.
- van Vliet, O. (2010). Divergence within Convergence: Europeanization of Social and Labour Market Policies. *Journal of European Integration*. 32. 3. 269-290.
- Wallace H., Wallace W. and Pollack A. M. (eds.) (2005). *Policy-Making in the European Union*, Oxford University Press.
- Weaver R. K. and Rockman A. B. (eds.) (1993). *Do Institutions Matter? – Government Capabilities in the United States and Abroad*, The Brookings Institution, Washington D.C.
- World Bank (2000). *Global Economic Prospects and the Developing Countries*.



# THE EFFECT OF EUROPEAN MONETARY INTEGRATION ON REGIONAL TRADE

Nenad Stanišić<sup>1</sup>

Nenad Janković<sup>2</sup>

**Abstract:** *Creation of monetary union eliminates the currency conversion costs, contributes to easier price comparison and eliminates the exchange rate risk in the union, which all in turn have positive effects on volume of trade and level of competition in the union.*

*The objective of this paper is to investigate the effect of European monetary integration on regional trade, and also to try to predict the contribution of possible further euro adoption on trade of European transition economies.*

*Creation of Economic and Monetary Union (EMU) has contributed to intra-union trade development indeed. In 1999, just before EMU started, the ratio of intra-union trade and union GDP was 27%. In 2010, it was 35%. In addition, the share of intra-union trade rise from 43 to 51% of total EMU members' trade. These findings prove the presence of trade creation effect of monetary integration in Europe. However, evidence suggests that this was a static, one-time effects with no long-term trend changings.*

*Based on EMU experience, European Union countries out of the EMU could expect that the possible euro adoption would rise their trade level and openness, which could contribute to their economic growth.*

**Keywords:** *monetary integration, international trade, trade creation*

## Introduction

Creating a single currency area eliminates the costs of currency conversion, enables better price comparison and eliminates the exchange rate risk, all of which positively affect the development of international trade among member countries and increase the competition in the market.

Elimination of currency conversion costs is the most obvious and the most measurable benefit of monetary integration. Although this cost is small in comparison to the transaction amount, research shows that annual currency conversion costs were measured in billions of euros in EMU countries, prior to creation of eurozone. According to estimations of the Commission of EZ, the savings achieved by introducing a single currency amount to 13-20 billion euros per year, i.e. about 1% GDP of the eurozone.

Monetary integration leads also to reduction in costs of exchange risk insurance, commissions for international payments, financial reporting costs, costs of managing financial assets in transnational companies and the like. The amount of all mentioned costs is proportional to the country's economic openness, thus profit from monetary integration is higher in case of countries whose markets are greatly connected.

The biggest incentive for international trade with member countries of the currency area is given by *elimination of the risk of exchange rate changes* with monetary integration, which reduces the overall foreign trade risk in the region. Without existence of different currencies whose values

---

<sup>1</sup> Faculty of Economics, University of Kragujevac, nstanisic@kg.ac.rs

<sup>2</sup> Faculty of Economics, University of Kragujevac

might change their relation over time, companies can, with greater accuracy, predict sales revenues or expenses of purchase on foreign market. In addition, the need for insuring the exchange rate risk through currency hedging disappears, reducing the operating costs. This benefit is greater for small companies as their costs of foreign currency hedging can be relatively high.

Volatility of relations between currencies of countries which are foreign trade partners can be an obstacle to international trade. A number of studies have empirically confirmed the greater economic integration of distant Canadian provinces with each other, than integration of southern Canadian provinces with neighbouring northern states of the USA. This conclusion was for long hard to explain theoretically, considering that, practically, there are no economic, and even language, cultural or any other barriers to the exchange of products and services and to the movement of people and capital between these two countries.

In seeking the answer to the mentioned paradox, the so-called "border effect", economists have not found anything that could pose a barrier to the trade integration of the USA and Canada, apart from different currencies and flexible exchange rate. The existence of different currencies can therefore be considered a sort of trade barrier, which can be removed through international monetary integration.

### **Dependency of trade volume on exchange rate regime**

There are nine exchange rate regimes according to the current classification of the International Monetary Fund. The significance of the decision about applying a specific regime results from empirically proven impact of the applied regime on performances of the economy. The only conclusion that can with certainty be drawn on basis of the decades of economic research is that there is no unique regime which would correspond to every country, as well as that there is no regime which would correspond to some country for an indefinitely long period of time. It can be concluded that the «optimal» exchange rate regime depends on a number of determinants that characterize a single economy in a given period of time or on country's individual economic characteristics such as structural characteristics of the economy, degree of dollarization (euroisation) of the economy, level of foreign exchange reserves, capital mobility, workforce flexibility, transmission mechanisms, inflation-rate movements, trade integration... The biggest problem with indicating these determinants is that in any case cannot be said that the list is final as it is constantly being updated due to the development of economic theory. Another problem is that it often happens that one criterion recommends the use of fixed exchange rate while, at the same time, some other criterion requires the use of flexible exchange rate. In that case, authorities in the field of economic development should decide which of the criteria would be more important, not just in that specific moment, but in the future as well. Priorities may change over time for sure, which can lead to changing the exchange rate regime in the respective country.

Theoretically, it can be said that countries are more inclined to use fixed exchange rate, euroisation and currency board arrangements if the economy is small and its openness high, if there is a high geographic concentration of exports, sector of exchangeable goods is of less importance and if inflation is lower, as well as trade deficit and external debt. Otherwise, countries tend to apply flexible exchange rates (Stanisic, Jankovic, 2012).

Graphical relationship between the volume of international trade and fluctuation in exchange rate can be represented by a convex line (Chart No. 1).

The degree of convexity of the line is determined by the proportion of small and large firms in national economies of the partner countries. According to the findings of one of the studies investigating this effect, the increase in trade after monetary integration is for the most part result of involvement in foreign trade of those firms which have not previously exported, and to a lesser extent

of increase in exports of firms which have previously launched their products in foreign markets (Baldwin, Skudelny and Taglioni, 2005).

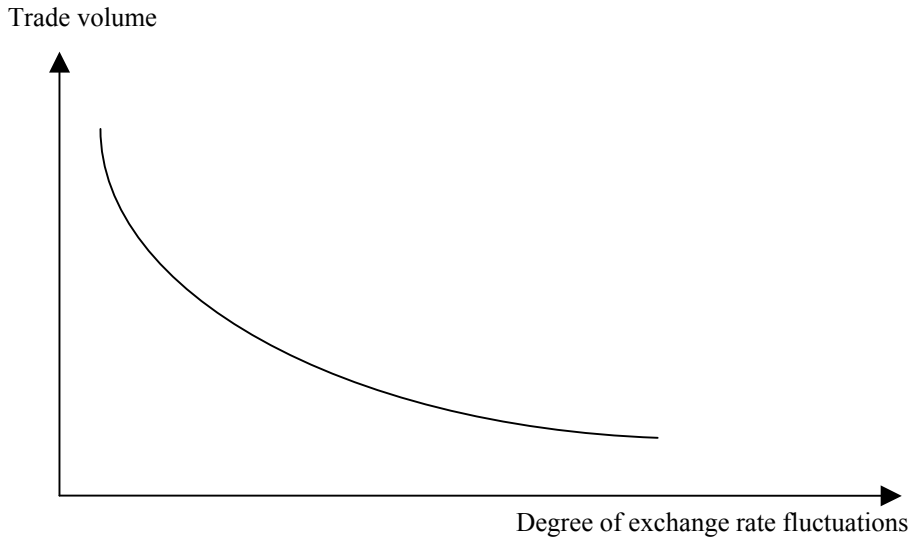

**Chart No. 1: Relationship between trade volume and level of fluctuation in exchange rate**

*Source: Baldwin, Skudelny and Taglioni, 2005*

Monetary integration with countries of the region enables reducing the above mentioned risks and thus contributes to increasing the number of export firms, which again increases the volume of trade among countries of the same currency area. Graphically observed, greater participation of small firms in the national economy implies a more convex line of trade's dependency on exchange rate volatility, and empirically, greater effect of monetary integration on the volume of foreign trade.

Recent literature clearly confirms the existence of a positive effect of monetary integration on the development of international trade in the region. This effect was first recognised by Andrew Rose in the late '90s (Rose, 1999). It was followed by series of studies which have confirmed the existence of this so-called «Rose effect», by taking the example of current and former monetary unions and countries applying dollarization.

Research on monetary integration's effects on trade between countries are based on analysis of a large number of data on bilateral trade of the countries in the long run. In assessing this impact the following regression equation is being used:

$$T_{ijt} = \beta_1 D_{ij} + \beta_2 (Y_i Y_j)_t + \sum_k \beta_k Z_{ijt} + \sum_t \delta_t T_t + \gamma CU_{ijt} + u_{ijt}$$

where:

$T_{ijt}$  – natural logarithm of trade between countries  $i$  and  $j$  during time  $t$ ,

$D_{ij}$  – logarithm of geographical distance between countries  $i$  and  $j$ ,

$Y$  – logarithm of real GDP,

$Z$  – other controlled variables,

$CU_{ijt}$  – dummy variable whose value is 1 if countries  $i$  and  $j$  are in a currency union during time  $t$  and, if not, its value is 0.

In focus of these studies is the coefficient  $\gamma$ , which measures the partial effect of monetary integration on trade.

A number of studies based on *cross-sectional* analysis of bilateral trade of many countries have shown that countries within the same currency area trade with each other much more often than the countries that do not have the same currency.<sup>3</sup> In a similar research, Rose came to the conclusion that countries of monetary integration trade nearly double as those that are not member states of the same monetary integration, after taking into consideration many factors which, apart from the common money, influence the volume of international trade (such as: per capita income, geographic distance, trade barriers, language etc.) (Rose, 2000). Other studies state that the effect of monetary integration increases trade by between 30% and 90% (Rose, Stanley, 2005).

The significance of monetary integration for the volume of trade between member countries has been confirmed also in case studies focusing on abandoning fixed currency parity. The experience of New Zealand can serve as an example. Until 1967, the New Zealand pound was for a long time fixed in 1:1 ratio with the British pound. In respect to other circumstances of the then British-New Zealand economic relations, this period can with reason be considered a form of incomplete monetary integration of two countries. Since 1967, New Zealand is not using its earlier currency parity to the British pound. This change turned out to be a reversal point in the volume of trade between New Zealand and Great Britain. In the late sixties began a long period of decline in the volume of bilateral trade of these two countries, so that, after three decades, it was reduced to about 50% of its previous value.

Rose and Glick have shown in their study that this was not a coincidence, researching 130 cases of abandoning monetary integration and fixed exchange rate in a long period of time (1948-1997), confirming a significant reduction on the volume of international trade after accepting a flexible exchange rate (Glick, Rose, 2001).

### **Effect of trade creation in euro zone**

Establishment of EMU has created completely new possibilities to study the relationship between monetary integration and trade. The main advantage of research on this issue based on experience of European countries is developed and reliable database, which is often a lack in researches based on examples of dollarized economies as in most cases these are small and/or undeveloped countries.

The results of previous studies indicate the existence of a positive effect that common currencies have on international trade within the euro zone. In the Table 1 is given the list of 24 studies with estimations of the effect of euro on the growth of regional trade.

---

<sup>3</sup> In such studies, apart from dollarization, currency board and currency zone, a fixed exchange rate with parity 1:1 is also considered monetary integration.

**Table 1: List of studies on the effect of euro on trade within EMU**

<i>No.</i>	<i>Authors</i>	<i>Year of the study</i>	<i>Estimated effect</i>
1	Bun and Klaassen	2002	39%
2	de Souza	2002	19%
3	de Nardis and Vicarelli	2003	6%
4	Cabasson	2003	88%
5	Micco, Stein, Ordonez	2004	9%
6	Barr, Breedon, Miles	2004	28%
7	Baldwin and Taglioni	2004	3%
8	Faruqee	2004	9%
9	de Nardis and Vicarelli	2004	10%
10	Clark, Timarisa, Wei	2004	25%
11	Baldwin, Skudelny, Taglioni	2005	105%
12	Adam and Cobham	2005	180%
13	Baxter and Koupritsas	2006	60%
14	Flam and Nordstrom	2006	15%
15	Berger and Nitsch	2006	0%
16	Gomes, Graham et al.	2006	7%
17	Baldwin and Taglioni	2006	-2%
18	Baldwin and Di Nino	2006	4%
19	Flam and Nordstrom	2006	26%
20	Bun and Klaassen	2007	3%
21	de Nardis and Vicarelli	2007	4%
22	Brouwer, Paap, Viaene	2007	7%
23	Flam and Nordstrom	2007	28%
24	de Nardis and Vicarelli	2008	9%

Based on the sample of above mentioned studies it is possible to conduct the so-called meta-analysis which represents a statistical method that is, by combining the results with respect to their reliability, used to assess the degree of influence of the observed independent variable on the dependent one. Therefore, meta-analysis is a sort of synthesis of various studies' findings about the significance and magnitude of a particular effect. The result of each study gets a specific «weight» that depends on the precision i.e. on standard error of the coefficient obtained. Using the described method, Rose came to the conclusion that the positive impact of monetary union on trade within the euro zone was statistically significant having a range from 8 to 23%, depending on the type of meta-analysis that had been used (Rose, 2008).

On the basis of statistical data it is possible to compare the volume and directions of trade between the countries of the euro zone in the period before and after the EMU creation. Expectations in terms of growth of intraregional trade have been largely satisfied in the first decade of the existence of the common currency. In 1999 trade between the countries of the euro zone was 27% of GDP in the EMU, and ten years later, about 35% of GDP. Another important feature of trade flows between the

## THE EFFECT OF EUROPEAN MONETARY INTEGRATION ON REGIONAL TRADE

countries of the euro zone is a huge share of trade within the EMU in the total foreign trade. Even more than 50% of foreign trade between the countries of the euro zone is a result of the mutual exchange of goods.

In terms of estimation of the common currency effect on regional trade, an interesting relationship is the one between intra- and extra-EMU trade before and after the creation of the euro zone (Chart 2).

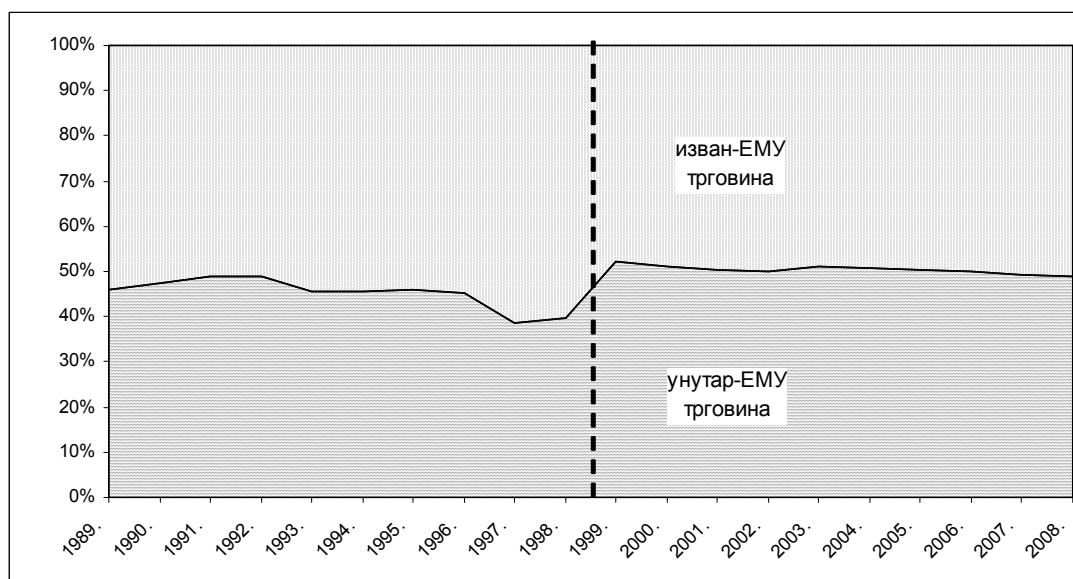

**Chart 2: Share of extra- and intra-EMU trade in the total foreign trade within the euro zone**

Source: authors' illustration on grounds of the database Direction of Trade, MMF, 2009

An increase in share of intra-regional trade has been noticed in the year of introduction of the euro, in order that since 2000 the relationship between intra- and supra-regional trade remained at a fairly constant level in the following years, with a slightly higher growth of trade with countries outside the euro zone. *Accordingly, the effect of introduction of the common currency on trade within the monetary union would rather be characterized as a current, static increase in the level of trade than as a continuing contribution to the growth of trade in the long term.*

The observed increase in trade of the countries of euro zone with the rest of the world is seen in the light of increasing globalization and high growth of world economy. However, the most important factor of the growth of foreign trade of EMU member states was enlargement of the EU to the east, on one hand, and on the other hand, the development of trade relations with fast-growing Asian economies.

Despite the proven increase in the volume of trade among the countries of the EMU, the common currency had not led to any significant *market arbitrage*. Expectations of economists that monetary integration in Europe will largely reduce the differences in prices of the same products that exist in different countries were not fulfilled, as it was shown in several studies (de Grouwe, 2007). There are three basic reasons for this. The first one is the lack of consumers' motivation to pass a long geographical distance because of small differences in prices. The second reason is considerable diversification of products, which makes it difficult to compare the prices. In the third place, in different countries there are still different regulatives in the field of wholesale and retail trade. All this



leads to differences in prices of the same products in different countries of the EMU, but also leaves room for future growth of trade.

Although greater trade openness is considered desirable for economic development of a country, one should be careful when assessing the benefits that monetary integration can bring to the countries at the low level of development if they are joining much more developed countries in the monetary union. The debate on level and distribution of benefits from international economic integration of developed and undeveloped countries has been going on for decades and represents a question to which it is not easy to give a single answer. Market integration of a country with economies that are much more developed may lead to regression of its economic structure.

### **Estimation of the effect of euro adoption on increase in foreign trade of the euro zone candidate countries**

All EU member states, apart from Denmark and Great Britain, are required to accept the euro once they meet the criteria of convergence. It is to highlight that Great Britain, as one of the leading European economies, does not show any interest to join the monetary union. However, willingness of other EU countries that are not member states of the euro zone changes often, as a consequence of the situation in the global and European economy.

Before the global economic crisis appeared in 2008, all European transition countries have accepted the euro adoption as their own economic goal. Despite the tendencies to adopt the euro as soon as possible, almost all countries of Central and Eastern Europe had at that time real problems with meeting the convergence criteria. Lower level of development, price liberalisation and rapid economic growth have caused higher inflation rates in transition countries than it was the case in countries of the EMU. Their economic growth was previously often financed by public finance deficit and constantly growing indebtedness of the country, its economy and population, which made it difficult to meet the defined criteria.

Faced with difficulties in meeting the specified criteria of convergence, governments of many transition economies have considered the unilateral adoption of the euro i.e. euroisation, but this idea was not approved by the officials of the EU and the ECB. The EU Directive 2000 prohibited the unilateral adoption of the euro.

The global financial crisis of 2008 and growing concern about its potential consequences for economies of Central and Eastern Europe triggered the idea of unilateral euroisation, and a whole storm of reactions was caused by the attitude of the IMF that the countries of that region should be allowed to accept the euro without having met the convergence criteria, but also without participation in the governing bodies of the ECB. This time as well, the officials of the EU and the ECB have pointed out that «there are no shortcuts» on the way to the euro and that the euroisation without having fulfilled the convergence criteria would be bad for the EMU, and even worse for those countries which implemented it that way.

However, willingness to adopt euro changed soon after the outbreak of the debt crisis in the euro zone in 2010. The problem of public finances in Greece, Ireland, Portugal and Spain has shaken the confidence in the euro and its long-term sustainability, and investors carefully monitor the measures taken to overcome the crisis. Still, it is reasonable to expect that, if it comes to success in overcoming the crisis without affecting the monetary union, interest in adopting the euro will be present again.

Among experts there is almost a consensus that, in a long term, adoption of the euro would be useful for the economies of all European transition countries. Arguable is, however, the right moment

## THE EFFECT OF EUROPEAN MONETARY INTEGRATION ON REGIONAL TRADE

to enter the EMU, as well as the fact that in terms of transition it is hard to meet the defined convergence criteria.

The benefit that former transition countries, now EU member states, could derive from joining the monetary union would be a result of a high degree of economic integration with the EMU member countries. The transition process in Europe has brought a rapid and remarkable change in geographical orientation of foreign trade. After two decades of transition, we can say that the countries which have joined the EU during the 2000s are fully integrated into the trade flows of the EU. The share of intra-EU trade in total trade of these countries is at the same level as in the old EU member states and in 2008 it amounted to 72%. Foreign trade openness of twelve new EU member states, measured by the ratio of imports and exports of goods and services to the GDP, was 126% in 2008, which is higher than in the group of fifteen old member states where it amounted to 109%.

During the transition it came to monetary stabilisation and raising the quality of monetary policy, especially in the later stages of transition. Still, credibility of monetary policy in these countries is far below the credibility that the ECB is known for. For this reason, accepting the euro would contribute to reducing inflation, inflation risk and real interest rates, which would positively affect the economic growth and contribute to further convergence in the level of development of the EU member states. Italy, Greece, Portugal, Ireland and Spain had similar experience after joining the euro zone. Higher rates of growth would result also from further strengthening of trade and financial flows within the EMU.

The second section of the paper emphasised the fact that creation of monetary union in Europe led to a short-termed increase in foreign trade of the member states by an average of 8% of GDP. Trade growth is a result of reduction in transaction costs, easier price comparisons and eliminating the exchange rate risk within the currency area. On the assumption that the effect would appear equally also in case of new countries joining the euro zone, it is possible to predict the degree of increase in foreign trade coefficient of ex-transition economies (Table 2). The results indicate that, by joining the EMU, foreign trade coefficient would be increased by 4 to 11 percentage points.

**Table 2: Estimation of the contribution of accepting the euro to increasing the foreign trade coefficient for the countries of CEE**

	FTC*, 2008.	Share of the EMU in total trade, 2008	Estimated increase FTC**	Estimated FTC after joining the EMU
Bulgaria	149	60	7	156
Czech Republic	155	85	11	166
Hungary	159	78	10	169
Latvia	103	69	6	109
Lithuania	122	60	6	128
Poland	84	78	5	89
Romania	75	71	4	79

\* Foreign trade coefficient, share of the sum of exports and imports of goods and services in GDP

\*\* Estimated increase of the FTC is calculated as product of the estimated effect of a common currency on the trade volume (8%), the share of EMU countries in total trade and FTC before monetary integration

*Source: authors' own calculation*

Magnitude of the benefits expected from joining the monetary union depends on the degree of trade integration of the candidate countries and their monetary stability. Data on the trade relations between EU member states inside and outside the EMU and data on average annual inflation rates in the period from 1999 to 2009 are given in the Table 3. Matrix on the expected benefits is presented in the Chart 3.

**Table 3: Trade integration and monetary stability in EU countries outside the euro zone**

	Share of EMU countries in total exports in 2008	Average inflation rate in the period from 1999 to 2008
Bulgaria	60	6,76
Czech Republic	85	2,79
Denmark	70	2,14
Latvia	69	5,81
Lithuania	60	3,00
Hungary	78	6,17
Poland	78	3,50
Romania	71	16,36
Sweden	60	1,88
Great Britain	57	1,82

Source: World Economic Outlook, *MMF*, 2009. and Eurostat, *www.eurostat.org*, November 2009

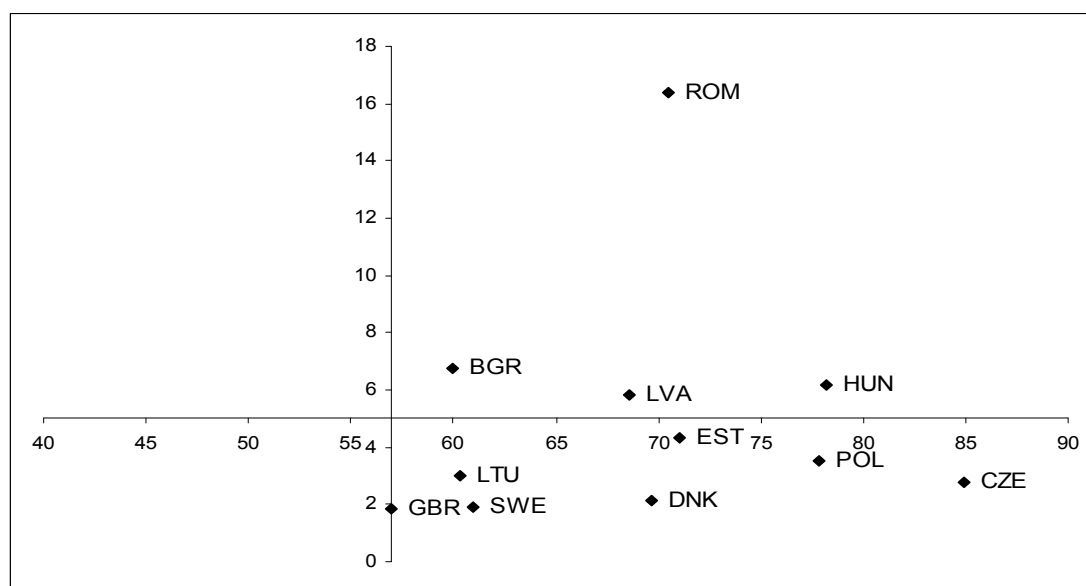

**Chart 3: Matrix of the benefits expected from adopting the euro for EU countries outside the euro zone**

Source: authors' own calculation

Based on the above-presented, the biggest benefits of joining the EMU would have Romania, Bulgaria, Hungary and Latvia (upper right quadrant of the Chart 3). The other seven EU countries (that are not member states of the EMU) are to find in the lower right quadrant of the Chart. Those are the countries whose foreign trade is predominantly directed towards the countries of the euro zone and which have relatively low growth in the general price level, so that the benefits of joining the EMU for them would be significant, but moderate.

The results obtained for Great Britain, Sweden and Denmark are interesting to compare with the results of the same analysis for the period before EMU creation, that is presented in the second section of the paper. Comparison indicates that the benefits expected from adopting the euro for past ten years have not changed in the case of those three countries.

### Conclusion

It has been empirically proven that the chosen exchange rate regime has an impact on economic performances of a country. Very important finding for economic policy makers is that, due to the constant changes (of internal and external nature), there is not a single regime that would be appropriate for all countries, as well as that there is no regime that would be applicable in some country for an indefinitely long period of time.

Monetary integration, or some of the strictly applied fixed exchange rate regimes (which are in certain cases aimed at achieving monetary integration in the future), brings to the member states a whole range of positive effects and the most important one is eliminating the risk of changes in exchange rate and thus fostering international trade. Contemporary literature confirmed, through various studies, the positive effect of monetary integration on the development of international trade. The so-called „Rose effect“ shows that the countries of monetary integration trade nearly double as those that are not member states of the monetary union.

Creation of the EMU has contributed, through developed and reliable databases of European countries, to even better studies on the effect of monetary integration on international trade. Numerous studies that have been conducted, despite giving different results, indicate the existence of an important positive effect of the common currency on international trade within the euro zone. The analysis conducted in this paper has shown that the trade among countries of the euro zone had grown from 27% of GDP to about 35% of GDP, for ten years of existence of the euro. Another important feature of trade flows among euro zone countries is a big share of trade within the EMU in the total foreign trade. Over 50% of the foreign trade of euro zone countries results from the mutual exchange of goods.

In the year of introduction of the euro it is to notice a statistically significant increase in the share of intra-regional trade within the EMU, in order that since 2000 the relationship between intra- and supra-regional trade remained at a fairly constant level. *Accordingly, the effect of introduction of the common currency on trade within the monetary union would rather be characterized as a current, static increase in the level of trade than as a continuing contribution to the growth of trade in the long term.*

A similar effect of adoption of the euro on trade volume could be expected also in the countries of Central and Eastern Europe that are EU member states, but have retained their national currencies. Although these countries have emphasized adoption of the euro as one of their main economic goals, the outbreak of the financial crisis in 2008 and the debt crisis in 2010 had mostly negatively affected their attitude towards monetary integration. The conducted analysis shows that the euro would contribute to the increase in foreign trade coefficient of the countries of Central and Eastern Europe for 4 to 11%, where the lowest benefits would have Romania, Poland, Lithuania and Latvia, and the highest would have Czech Republic and Hungary. If the current crisis in the EMU is resolved in a

manner that does not endanger the monetary union and the common currency, it is possible to expect the interest in adopting the euro to be strengthened again, and then the benefits from adopting the euro would influence not only growth of foreign trade, but also long-term macroeconomic stabilisation and decline in interest rates.

### Acknowledgments

The paper is part of research conducted within the project III-47005 - "Research and Development of the Platform for Scientific Support to Decision-making and Managing the Development of Science and Technology in Serbia", financed by the Ministry of Education and Science of the Republic of Serbia

### References

- Baldwin, R., F. Skudelny i D. Taglioni. (2005). *Trade Effect of the Euro: Evidence from Sectoral Data*, European Central Bank, working paper, No. 446.
- De Grouwe, P. (2007). *Economics of Monetary Union*, Oxford University Press, p.66.
- Glick, R. and A. Rose. (2001). Does a Currency Union Affect Trade? *The Time Series Evidence*, NBER working paper, No. 374.
- IMF (2010). *De Facto Classification of Exchange Rate Regimes and Monetary Policy Framework*. Washington, DC.
- Rogoff, K. et al. (2004). *Evolution and Performances of Exchange Rate Regimes*, Occasional Paper 229, IMF. Washington, DC.
- Rose, A. (1999). *One Money, One Market? The effect of Common Currencies on International Trade*, University of California at Berkeley, p.31.
- Rose, A. (2000). *One Money, One Market: Estimating the Effect of Common Currencies on Trade*, *Economic Policy*, br. 30, pp 9-45.
- Rose, A. i T. D. Stanley. (2005). *A Meta Analysis of the Common Currencies on International Trade*, *Journal of Economic Surveys*, vol. 19, No. 3, pp. 247-265.
- Rose, A. (2008). *Is EMU Becoming the OCA? Evidence on Trade and Business Cycle Synchronisation*, *Euro at ten*, European Central Bank.
- Stanišić, N. (2010). *Izazovi međunarodne monetarne integracije*, *Neobjavljena doktorska disertacija*, Ekonomski fakultet Univerziteta u Kragujevcu, Srbija
- Stanišić, N. (2012). *Efekti međunarodne monetarne integracije na inflaciju, privredni rast i tekući bilans*, *Ekonomski horizonti*, 14(1), Ekonomski fakultet u Kragujevcu, str. 3-12.
- Stanišić, N. i Janković, N. (2012). *Veličina i otvorenost privrede kao determinante režima deviznog kursa tranzicionih zemalja*, *Zbornik radova sa naučnog skupa: Institucionalne promene kao determinanta privrednog razvoja Srbije*, Ekonomski fakultet u Kragujevcu, str 213-229.



# CONTEMPORARY PROTECTIONISM, CRISIS AND THE ROLE OF WORLD TRADE ORGANIZATION

Jelena Tešić<sup>1</sup>

**Abstract:** *Experience of the previous crises suggests that conditions of crisis cause changes and shifts in foreign trade policy of countries. There is no unique opinion in the scientific and expert community neither upon the rise of protectionism during the recent crisis neither upon the role of WTO in curbing protectionism. One of the possible explanations of this disaccord is the nature of cotemporary protectionism. In contrast to tariff protectionism in times of Great Depression, protectionism during the recent crisis includes wide range of sophisticated, often invisible non-tariff barriers, what is in the scientific literature characterized as the murky or hidden protectionism. The subject of this paper is to analyze specificity and trends in the implementation of protectionist measures as a result of the global economic crisis, and in that context, to asses the role of the WTO in curbing protectionism during the recent crisis.*

**Keywords:** *measures of protectionism, murky protectionism, global economic crisis, World Trade Organization.*

## Introduction

Except for the periods of economic crises, the period from World War II has been characterized by constant and fast increase of international trade and constant efforts in its liberalization. Global economic crisis that appeared in financial sector in 2007 had adverse impact on pre-crisis trends of international trade and trade policy of countries. International trade in 2009 recorded the deepest decrease since the World War II of 12.5% annually, while quarterly drops were sharp, synchronized and sudden, being characterized in the scientific literature as *The Great Trade Collapse*.

Protectionist response in conditions of the current economic crisis is not in the style of trade war as was the case during the Great Depression. There are several reasons for this: first, contemporary nature of international trade and high economic interdependency in globalized world constrain a certain level of protectionism (Dadush et al., 2011); second, measures applied during the Great Depression (tariff and quotas) are regulated by the multilateral trade rules, and third, maybe the most important factor is that in contemporary times there is much wider range of instruments of monetary and fiscal policy to cope with crisis (Irwin, 2009). Although an open trade war was not characteristic of the latest crisis, intensified use of protectionist measures, mainly in the form of non-tariff barriers, has been recorded.

International institutions, principally World Trade Organization - WTO, and other institutions such as United Nations Conference on Trade and Development - UNCTAD and Organization for Economic Co-operation and Development - OECD, since the third quarter of 2008 have introduced stronger surveillance of foreign trade policies of countries because of the fear of possibility of greater protectionist reactions. Some other initiatives like the one introduced by the Center for Economic Policy Research (CEPR), under the name Global Trade Alert, have also been established with the scope of analysis of foreign trade measures introduced in the period of crisis.

Preliminary examinations show that there is no unique judgment in the scientific and expert community upon the question at what extent protectionism has been reaffirmed in the crisis. These

---

<sup>1</sup> Faculty of Economics, University of Banja Luka, jelena.tesic@efbl.org

different opinions supervene from the fact that in contemporary times protectionist measures are most often applied in the form of different non-tariff barriers whose effects are hard to measure and whose application is non-transparent. Some researchers (Baldwin, Evenett, 2009; Evenett, Wermelinger, 2010; Haddad in Griswold et al., 2011) particularly emphasize the character of contemporary protectionism in the recent crisis because many of the newly introduced measures were in the form of so called murky or hidden protectionism. These kinds of measures are often invisible because they do not violate WTO rules or they are not even regulated by these rules but the effects of these measures is direct or indirect discrimination of foreign competition.

Another point of disaccord in the scientific and expert community is upon the role of World Trade Organization in prevention of protectionism. While some authors emphasize the role of the WTO, there are some who question its role. The later emphasize that protectionist reaction has not been curbed principally by the WTO rules, except for tariffs, but mainly by the contemporary nature of international trade, i.e. high proportion of international trade in components and intra-firm trade, and also by wider range of instruments of fiscal and monetary policies. They also emphasize insufficiency of WTO rules in regulating a wide range of non-tariff barriers.

These disagreements among scientists and experts give a full justification to deeply analyze specificity and trends in the implementation of protectionist measures as a result of the global economic crisis, and in that context, to assess the role of the WTO in curbing protectionism during the recent crisis.

### **Different concepts on the rise of protectionism in the crisis**

#### ***Investigations within World Trade Organization***

From October 2008 WTO introduced additional monitoring of foreign trade policies of its members. In January 2009 WTO's first report was released. The report under the name *Report to the TPRB from the Director-General on the Financial and Economic Crisis and Trade-Related Developments* gives an overview of foreign trade policies and lists introduced crisis-related measures by the members and accession countries of WTO (WTOa). Series of quarterly reports have been published until today and these serve as a basis for the annual report issued by the Trade Policy Review Body-TPRB under the name *Overview of Developments in the International Trading Environment, Annual Report by the Director-General* (WTOb).

The conclusion of the first report from Director-General released in January 2009 was optimistic where he stated that "to date, most WTO Members appear to have successfully kept domestic protectionist pressures under control" (WTOa, January 2009: p. 1). Already in his second report in April 2009, WTO Director-General warned about obvious trend of increased use of measures that directly or indirectly affect international trade. In that report "the significant slippage in protectionism has been recorded" (WTOa, April 2009: 1). Following the next reports of the WTO, in 2010 due to recovery of economic growth and strong recovery of international trade, protectionist pressure decreased (WTOa, November 2010: p. 1). However, deterioration of economic situation in 2011 provoked again a pressure on governments to protect their domestic economy to which, according to WTO, countries successfully resisted following the rules of the international trading system (WTOa, November 2011: p. 1).

It is interesting to see assessment of the WTO about coverage of world trade by crisis-introduced measures which only refer to those measures that affect import.



**Table 1: Share of world trade covered by new import restrictive measures (in %)**

October 2008 to October 2009	November 2009 to mid-October 2010	Mid-October 2010 to mid-October 2011	Mid-Oct 2011 to mid-May 2012
1.01	1.20	0.87	0.90

Source: WTO - *Overview of Developments in the International Trading Environment, Annual Report by the Director-General, Trade Policy Review Body, November 2011* and WTO - *Report to the TPRB from the Director-General on the Financial and Economic Crisis and Trade-Related Developments, June 2012* <http://www.wto.org/>

Regarding the types of discriminatory new measures, full list with detailed explanation of each measure can be found in mentioned reports. Summary overview of the number and types of the measures recorded by the WTO is presented in the next table.

**Table 2: Number and types of trade restrictive measures from October 2008 till May 2012 (members and accession countries)**

Type of restrictive measure	October 2008 to October 2009	November 2009 to mid-October 2010	Mid-October 2010 to mid- October 2011	Mid-October 2011 to mid- May 2012
Trade remedy	184	122	129	78
Border	105	62	126	72
Export	20	25	64	19
Other	15	13	20	13
Total	324	222	339	182

Source: WTO - *World Trade Organization. Overview of Developments in the International Trading Environment, Annual Report by the Director-General, Trade Policy Review Body, November 2011* and WTO - *Report to the TPRB from the Director-General on the Financial and Economic Crisis and Trade-Related Developments, June 2012* <http://www.wto.org/>

According to the official stance of WTO, there is no reason to characterize crisis protectionism as an escalated one. In such developments, WTO emphasizes its role as a guardian of the international trading system. Regarding the role of WTO and level of protectionism in the crisis, there is no unique opinion in the scientific and expert community. Some researchers (Dadush, 2009; Messerlin, 2009; Wolfe, 2011) emphasize the role of WTO rules and the world trading system, while others (Evenett, 2011; Erixon, Sally, 2010; Gamberoni, Newfarmer, 2009; Gregory et al. 2010; Bussière et al. 2010) have a quite opposite stance about escalation of protectionism during the crisis. According to them, not only that there is evident increase of protectionism in the crisis but there is also evident insufficiency of WTO rules in preventing the protectionism. Increased use of protectionist measures is observed by these researchers through the prism of hidden or murky protectionism. The most frequently used database of protectionist measures during the recent crisis is *Global Trade Alert*, established by Centre for Economic Policy Research.

### Investigations within the *Global Trade Alert* project

The project has been initiated in November 2008 principally as a need for monitoring of crisis reaffirmed protectionism<sup>2</sup>. Since then, GTA periodically publishes summary publication on applied measures in conditions of crisis, and until now, it has published eleven reports. Findings of the GTA are quite different compared to those of WTO. Recorded measures are not constrained to measures regulated by the WTO, but refer to all measures that affect international trade<sup>3</sup>. From its beginning in November 2008 until June 2012 when the last report was released there were 2431 state measures recorded in GTA database, of which (CEPR, June 2012: p. 22.):

- 1340 red measures
- 538 orange measures
- 553 green measures

As the GTA reports state, the level of protectionism in the crisis is considerably higher than in the pre-crisis times. Proof for that is in the number of discriminatory measures which surpasses number of liberalizing measures by 3.4 to 1 (3.4:1). Let's emphasize also that the number of implemented discriminatory measures recorded in the GTA database is considerably higher than the number of *all measures* recorded by WTO since the later source does not classify the measures by their discriminatory character – GTA records 1878 discriminatory measures (red and orange) compared to 1067 of all measures recorded by the WTO in the period from November 2008 to June 2012.<sup>4</sup>

In the sixth GTA report which covers the period from November 2008 till September 2010, for the first time GTA researchers estimated percent of the world import covered by crisis-related protectionist measures. This initiative was inspired by the WTO findings which have been constantly emphasizing that only small part of world trade is affected by new measures – according to them 2.2% of world import was affected in the period from November 2008 till September 2010. By conservative methodology employed in GTA report, authors estimated that only 22 discriminatory measures, which they called “jumbo” measures, covered almost 15% of world import. Jumbo measures are those that harm large number of trade partners and affect a significant amount of international trade according to thresholds that authors set in their methodology (Evenett, Fritz, 2010). This means that the percent of world import that is covered by all measures is much higher than these 15% covered only by jumbo measures.

In order to more precisely present a difference between findings of these two sources, and taking into consideration Table 2 about WTO-recorded number and types of crisis-related measures, we present the structure of measures which have been applied in the crisis according to GTA findings.

We can see that the government bailouts and state aid, i.e. generally called *stimulus measures* were the most often type of discrimination. Although their discriminatory character is not evident at the first sight, in contrast to measures where it is obvious (like import ban for example) we stress here

---

<sup>2</sup> GTA initiative is established by the network of world institutes and their eminent researchers. It is supported by the World Bank and some other international institutions.

<sup>3</sup> GTA classifies the measures into three categories: red – measures that almost certainly discriminate against foreign commercial interests, orange – the measures that may involve discrimination against foreign commercial interests and green – measures that involve liberalization on a non-discriminatory basis. The sample of countries that are covered by GTA database includes almost all countries of the world.

<sup>4</sup> It is true that the sample of GTA is slightly wider, but the difference is insignificant since the sample of WTO includes accession countries making thus its sample of 184 countries.

that the stimulus measures are classified as the red ones in GTA database. More than 70% of all stimulus measures were directed to non-financial sector (CEPR, June 2012: p. 26). It is wrong to connect stimulus measures only with the financial assistance given to financial sector. Although many of these were not direct violation of formal-WTO trade rules, it does not diminish their discriminatory character.

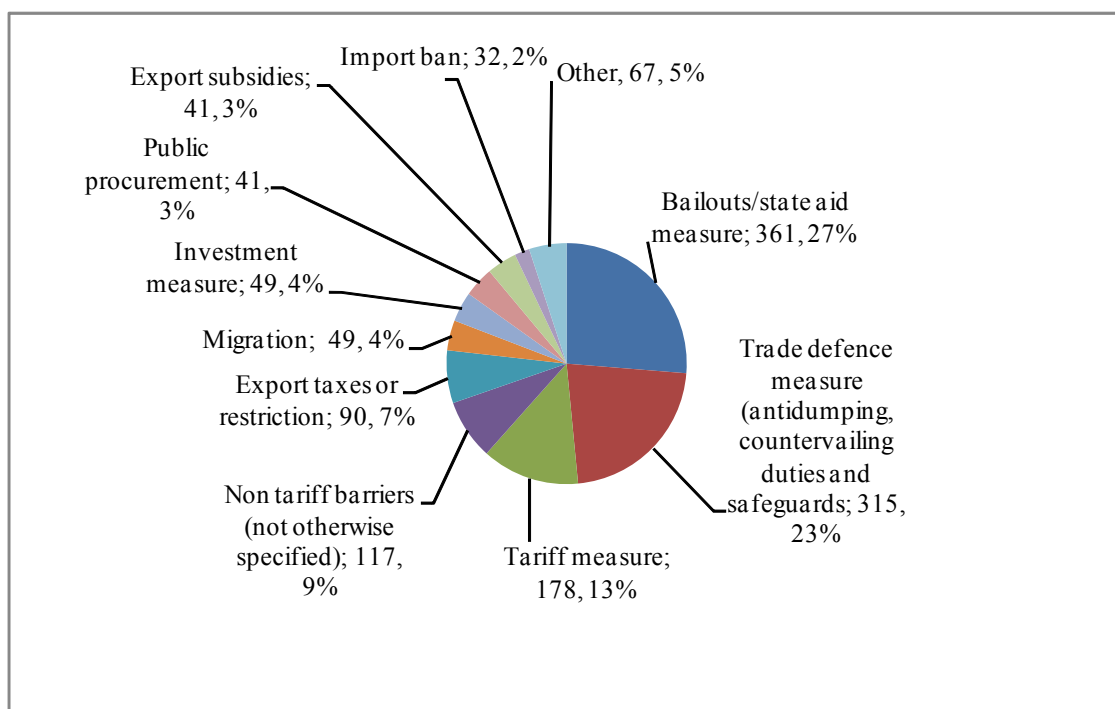

**Figure 1: Structure of implemented protectionist measures from November 2008 till June 2012 (for all countries included in GTA database)<sup>5</sup>**

All in all, according to GTA findings, among ten the most used discriminatory state measures there are non-tariff barriers, export taxes and restrictions, migration measures, and public procurement, which all represent measures where multilateral trade rules are limited or even non-existing. Tariff increases and trade defence instruments account together for less than 36% of all discriminatory measures while official reports use particularly these two measures (tariffs and trade defence instruments) when they want to stress that crisis protectionism has been kept at bay.

### **Difference between WTO and GTA findings – role of murky protectionism**

There is much higher pessimistic attitude upon the protectionism in the GTA reports than in the official reports of the WTO. As previously showed, there is also considerable difference between these two reports if one considers their concrete data and results. Why is that so?

<sup>5</sup> Source: CEPR-Centre for Economic Policy Research. *Global Trade Alert*, eds. Simon J. Evenett, June 2012, available on: <http://www.globaltradealert.org/>

An important question concerns the *types of measures* tracked by both sources. GTA database includes larger number of measures and it is not constrained on measures regulated by WTO. At the same time, its traffic light system of red, orange and green measures does not differentiate measures on the basis of their inconsistency with the WTO rules but discriminatory character of measures is assessed by GTA researchers on the filed. There is a great deal of measures that are allowed by the WTO rules while they were characterized as discriminatory measures according to GTA database. Often mentioned example of such a measure is public procurement with discriminatory provision “Buy American” included in the American stimulus package *American Recovery and Reinvestment Act of 2009*. Except for the United States, provision „buy national“ in stimulus packages was applied also by China, Algeria, Australia, Brazil, Paraguay, Nigeria, Turkey, South Africa, Ukraine, Russia, Indonesia, Kazakhstan, Uruguay and Canada. The question of public procurements is regulated by the plurilateral *Agreement on Government Procurement* within the WTO which has been signed by 37 countries and accession countries (including the countries of EU). Many of the Agreement signatories applied „buy national“ provision in their stimulus packages.

The fact that no countries have appeared to have broken their tariff bindings at the WTO has been often regarded as the proof that countries respected the rules of international trading system in the crisis. It is true that the trade war was not reaction of countries in the latest crisis, but the absence of trade war does not imply absence of discriminatory measures in the crisis. One could rather conclude that there are constant changes in the types of applied measures that are used in contemporary times. In contrast to tariff protectionism during the Great Depression, protectionism in conditions of the recent crisis includes wide range of sophisticated, often invisible, non-tariff barriers, what is in the scientific literature characterized as the *murky* or *hidden* protectionism. (Baldwin, Evenett, 2009: p. 4).

Murky protectionism needs not involve a direct violation of WTO obligation, but represents an abuse of the legitimate discretion given to the State to discriminate against foreign goods, companies, workers and investors (Evenett, Wermelinger, 2010: p. 8). According to them, there were many examples of murky measures in the recent crisis. These include “buy local” provisions in stimulus packages, bailout packages for selected domestic firms in tradable sectors, so called green protectionism which involves green policies that subsidize domestic manufacturing of environmental goods and discriminatory use of allowed measures under the guise of consumer and/or producer protection like the use of trade defense measures, sanitary and phytosanitary standards and technical barriers to trade (SPS and TBT).

The problem of the murky protectionism, is in the difference upon the set of policy instruments that analysts perceive as protectionist and the attitude of public officials upon the same thing, enabling the officials to “deny that they have engaged in less well-known forms of protectionism” (Evenett, 2011: 3). Furthermore, according to Eventt (2011) even if certain forms of murky protectionism undoubtedly discriminate against foreign commercial interests, it is often hard to document them (and therefore, easier to deny them), and typically these forms are only lightly regulated by WTO rules.

Other researchers, using GTA database, also warned about murky forms of protectionism. According to Mona Haddad of the World Bank (Haddad in Griswold et al., 2011), contemporary trade barriers in the recent crisis took many forms, i.e. protectionism today is primarily in the form of various non-tariff measures - NTM, from administrative barriers and sanitary regulations to subsidies and export promotion measures. The most worrying finding of Haddad (2011) is the effect of NTM which although difficult to determine, for some of these measures could set a significant costs, creating tariff equivalents that can reach 50 percent.

### **Role of the WTO and international trade rules in the crisis**

Another point of disaccord in the scientific and expert community is upon the role of WTO in prevention of protectionism. Numerous researchers and scholars argue that the rules of current international trading system had an important role in preventing protectionism in the midst of crisis. If one follows Dadush et al. (2011), the rules of WTO played an important role in restricting protectionism. But, as he adds, the WTO is only one part of the world trading system since the later is constituted also by national laws and regulations, bilateral and regional treaties and plurilateral agreements. Except for international rules, other factors also constrained protectionism, such as wider range of instruments of fiscal and monetary policy and “facts on the ground” or “granularity of trade” which is characterized by the high proportion of international trade in components, intra-firm trade and the increased interest of retailers and consumers in imports. However, among all these factors, this author puts the role of the WTO in the first place.

Similar attitude considering this issue could be found in Haddad and Sheperd (2011). As they point out, “all in all, the multilateral trading system, with the WTO at its center, has weathered the storm of protectionism pressure relatively well”.

For Robert Wolfe, WTO also played a critical role in fight against protectionism during the crisis. As this author states “I think that institutions are consequential” (Wolfe, 2011: 6). He emphasizes that surveillance mechanism of trade policies of G20 and other countries, which has been operational since the crisis erupted, was the key in protectionism prevention. Namely, G20 except for promising to refrain from new import and export discriminatory measures or WTO-inconsistent measures, promised also to notify promptly the WTO of any such measures and accepted WTO and other international institutions with their mandate to monitor and publicly report on these undertakings on a quarterly basis. According to Wolfe (2011) “G20 members of the WTO faced a double requirement in the crisis: to act consistently with their long-standing regime obligations and to fulfill their specific crisis-related commitments”.

Yet, there are some other researchers who certainly question how WTO could have prevented the escalation of protectionism (Evenett, 2011). In his latest work, this author presents a very detailed assessment of the contribution of WTO to the resort to protectionism and the role of WTO rules and international trading system during the crisis. By many arguments, he questions the credit of WTO as a guardian of world trading system and poses many questions regarding the adequacy and sufficiency of WTO rules. He firstly asks whether WTO rules really constrained the use of discretionary trade policy interventions manifested in braking up the rules of tariff binding. According to Evenett (2011), the fact that no countries have broken up their WTO bound tariff rates is not the merit of these rules. Contrary, many WTO members, more than 85 of them, including important trading nations such as Australia, Brazil, India, Indonesia, Mexico Nigeria, South Africa, and Turkey, could have all increase their tariff in the level with Smoot Hawley tariff without breaking their WTO obligations. Opportunity for this is given by the difference in their applied and bound rate. These 85 members have average maximum allowed or bound tariff rates on manufactured goods that were 6 or more percentage points higher than their applied rates. According to Evenett (2011: 15) “for these 85 of the WTO members the legal constraints on discretionary trade policy are so weak that they could not stop the return of 1930-style global protectionism”.

Second, professor Evenett seriously reviews the WTO dispute settlement procedure, which is according to him, “arguably much weaker than many realize” (Evenett, 2011: 16). This argument is based on the fact that the procedures in the dispute settlement mechanism are so slow that some government could purposely break the rules of WTO knowing that it will take a several years before it has to withdraw its measures after the Appellate Body ruling is passed on. Surely, these considerations

are not hypothetical, but rather confirmed in the practice of WTO. The second problem of DSM is that there has to be another WTO member to “bring a case against an errant government” (Evenett, 2011: 17). There are many of reasons why some governments do not bring cases against others.

Third, and maybe the most important problem of WTO rules, which appeared to be a real problem in the systemic crisis, is their insufficiency. A critical thing is the fact that the WTO rules, where discrimination is possible, are weak, underdeveloped, or do not exist at all. The consequential problem is that WTO systematically collects information in the areas of government policy where its rules are strongest but this is not the case with other areas of policymaking. This caused that the most of the crisis-era protectionism was directed towards those areas where the WTO rules are weaker. There are numerous examples which we also mentioned in this paper that confirm this fact. Among these, huge financial spending will be remembered as the most important characteristic of the crisis. Problem of these measures is that many countries used them in discriminatory way, breaking thus collectively, one by one the WTO rules on subsidies and bailouts. But, as Evenett points “the facts that the WTO rules on subsidies are not that far reaching, that no organization was in place to actively monitor this less than conventional form of discrimination, and that therefore there was no smoking gun that the media could report on without doing a substantial amount of research on its own” (Evenet, 2011: 17).

\* \* \*

The consensus between mentioned authors however exists when it comes to the need of future WTO reform. It is very important to make a progress in regulating those measures for which the current WTO rules are insufficient or even do not exist at all. Consequently the need for its reform in order to move forward within Doha, beyond Doha or even less-then-Doha is obvious. Also, the WTO has to adjust its functioning to constantly changing international environment which is characterized by the growing role of developing countries and growing role of other-than-WTO agreements. Huge problem of the WTO, where the strongest reform is needed, is dispute settlement mechanism which, although properly settled, is slow to ensure efficient results. All these problems need to be tackled by its members and within the WTO. Otherwise, its role in the complex international trading system will be further diminished.

## **Conclusion**

It is evident that in the scientific and expert community there is no unique opinion at what extent protectionism has been reaffirmed in the recent crisis. These different opinions are result of the constantly changing and evolutionary character of protectionism. Sophisticated and nontransparent non-tariff barriers with ambiguous effects or so called murky protectionism do not enable exact determination of protectionism rise in the crisis. Problem of the murky or hidden measures is that “they manage to fly below the WTO radar”, as the leading Japanese economist Shujiro Urata (2009) explained. What could be determined, however, is the way countries have protected themselves. By analyzing the type of measures that have been applied in the crisis, it is easy to conclude how well diversified is the range of non-tariff barriers of contemporary protectionism.

This ambiguity in defining the discriminatory character of certain measures caused the difference in findings upon the crisis-related measures tracked by two independent sources – WTO and GTA, which are, according to our findings, the most relevant and most cited sources about the subject. First important difference relates to the number and types of recorded discriminatory measures. Another difference between GTA and WTO reports relates to the coverage of world trade by crisis-introduced measures. Both of the differences supervene from the fact that the measures

included in the WTOs assessment relate only to *new import restrictive measures* and these are typically tariffs and trade defense measures while GTA database includes larger number of measures and it is not constrained on measures regulated by WTO. In our opinion, the differences between WTO and GTA do not imply a substitution of these sources but rather their complementarities. In order to have a more clear vision of contemporary protectionism and protectionist reaction during the crisis, one should consult both.

Except for the role of WTO in curbing protectionism during the crisis, upon which there is no unique stance, maybe it is more important to conclude that the future liberalization of international trade will be further decelerated as a result of the crisis, especially in the area of non-tariff barriers, i.e. different and additionally developed forms of new protectionism. In the light of so called murky protectionism, insufficiency of WTO rules appeared to be a huge problem in the crisis. There is a strong need to additionally regulate and put some forms of measures within the framework of the WTO. Even though the trend of international trade liberalization was slow in the decade prior to the crisis, regarding the fact that Doha Round has not been concluded, it is essential for the members of WTO to find a way and move forward with further liberalization. This will surely depend on the overall global economic environment which, according to the latest forecasts, is not very promising.

## References

- Baldwin, R. and S. Evenett (eds.) (2009). *The collapse of global trade, murky protectionism, and the crisis: Recommendations for the G20*, A VoxEU.org publication, London: Centre for Economic Policy Research
- Bilal, S. et al. (2010). Keynes at Home, Smith Abroad—the Right Approach?. The Carnegie Endowment for International Peace.  
<http://carnegieendowment.org/2009/11/23/keynes-at-home-smith-abroad-right-approach/477p>
- Bussière, M. et al. (2010). Protectionist Response to the Crisis Global Trend and Implications. Occasional Paper Series no. 110 / May 2010. Frankfurt: European Central Bank
- Dadush, U. (2009) WTO Reform, The Time to Start is Now. Policy Brief 80, The Carnegie Endowment for International Peace
- Dadush, U. et al. (2011). Is Protectionism Dying. The Carnegie Papers, International Economics, The Carnegie Endowment for International Peace
- Erixon, F. and R. Sally (2010). Trade, Globalization and Emerging Protectionism Since the Crisis. Working Paper no. 02/2010. Brussels: The European Centre for International Political Economy ECIPE
- Evenett, J. S. (2011). Did WTO Rules Restrain Protectionism During the Recent Systemic Crisis?. Discussion Paper Series 8687, Centre for Economic Policy Research
- Evenett, J. S. and J. Fritz (2010). Jumbo Discriminatory Measures and the Trade Coverage of Crisis-Era Protectionism. In: *Unequal Compliance: The 6th GTA report* (Evenett, J. S., eds.). London: Centre for Economic Policy Research, 49-59.
- Evenett, J. S. and M. Wermelinger (2010). A snapshot of contemporary protectionism: how important are the murkier forms of trade discrimination?. In: *Rising Non-Tariff Protectionism and Crisis Recovery* (Mikic, M. and M. Wermelinger, eds.), Bangkok: United Nations Publications, The Asia-Pacific Research and Training Network on Trade, 8-27.
- Gamberoni, E. and R. Newfarmer (2009). Trade Protection: Incipient but Worrisome Trends. Trade Notes 37. International Trade Department World Bank
- Gregory, R. et al. (2010). Trade and the Crisis: Protect or Recover. *Journal of International Commerce, Economics and Policy*, 2, 165-181

- Griswold, D. et al. (2011). The Future of Protectionism. The Carnegie Endowment for International Peace. <http://carnegieendowment.org/2011/05/26/future-of-protectionism/nzl>
- Haddad, M. and B. Shepherd (2011). Managing Openness: From Crisis to Export-Led Growth v2.0, In: Haddad M. and B. Shepherd (eds.), *Managing Openness: Trade and Outward-Oriented Growth after the Crisis*, Washington: World Bank
- Hufbauer, G. et al. (2009). Crisis, Protectionism, and Doha—What Future for the WTO?. The Carnegie Endowment for International Peace. <http://carnegieendowment.org/2009/09/15/crisis-protectionism-and-doha-what-future-for-wto/204b>
- Irwin, D. (2009) Avoiding 1930s-Style Protectionism: Lessons for Today. In: Evenett, S. et al. (eds.) *Effective Crisis Response and Openness: Implications for the Trading System*, London: Centre for Economic Policy Research
- Messerlin, A. P. (2009). A significant slippage in protectionism? Not yet. Policy Brief 12 May. Groupe d'Économie Mondiale at Science
- Urata, S. (2009). Battling Protectionism in the Global Financial Crisis. *Global Asia*, September 2009 [http://www.globalasia.org/V4N3\\_Fall\\_2009/Shujiro\\_Urata.html](http://www.globalasia.org/V4N3_Fall_2009/Shujiro_Urata.html)
- Wolfe, R. (2011). Did the protectionist dog bark? Transparency, accountability, and the WTO during the global crisis. Policy Report March 2011. Stockholm: Entwined

#### **Official Reports on Crisis-Related Measures**

- CEPR - Centre for Economic Policy Research. *Global Trade Alert*, (eds.) Evenett, S. J. ten periodical issues (June 2009–June 2012), available at <http://www.globaltradealert.org/>
- World Trade Organization (WTOa). *Report to the TPRB from the Director-General on the Financial and Economic Crisis and Trade-Related Developments*, Trade Policy Review Body, Geneva: WTO. periodical issues (January 2009–June 2012), available at <http://www.wto.org/>
- World Trade Organization (WTOb). *Overview of Developments in the International Trading Environment, Annual Report by the Director-General*, Trade Policy Review Body, yearly issues (2009, 2010 and 2011), available at <http://www.wto.org/>
- WTO, OECD, UNCTAD. *Report on G20 Trade and Investment Measures*: several periodical issues (September 2009–October 2011), available at <http://www.wto.org/>



# THE CHALLENGES OF POST CRISIS GLOBAL DEVELOPMENT – ROLE OF FAST GROWING MARKETS

Snežana Popovčić-Avrić<sup>1</sup>

Marina Đenić<sup>2</sup>

**Abstract:** Strengthening interdependence in world economy under globalization poses many challenges in the way of successful positioning *on* the international market. The current crisis further complicates international economic environment in which countries and their companies beyond the traditional principles of competitiveness and explore new opportunities for the successful positioning in the recession. The paper will point to the repositioning of key players in the world economy and will analyze how shift of business focus on the fast-growing countries affects the dynamics of trade and investment flows. The basic hypothesis is that fast-growing markets have a positive impact on the world economy development. Using correlation model, the paper analyzes whether these *markets* represent an opportunity in sense that through strengthening they make bigger influence on the world economy or whether these *markets* represent a threat *through* increasing competition.

**Keywords:** *globalization, competitiveness, repositioning, fast-growing markets*

## Introduction

Economic trends in first decade of the 21st century and the growing economic integration of the world, reveal significant changes in the world economy. Until recently, the world economy has been dominated by the „advanced“ countries of Europe, North America, and Japan. The previously said is changing rapidly. New patterns of trade and international specialization have been the road toward rapid economic development in East and South Asia. The pace related to economic growth in this part of the „third world“, particularly in China and India, far outstrips growth in the „first world“. Developing countries that not so long ago were primarily producers of agricultural products and raw materials, far out on the periphery, are today core producers of manufactures supplying the older, more mature economies. (Adams, 2011, p.4)

Existing tendency shifting the focus of economic activity from developed to emerging markets, has been further intensified by the global economic crisis. The developed countries, without a doubt, in the future will be key players in the world market (12% of the world's population who lives in developed economies generate 44% of world GDP and 45% of world exports). However, the current crisis is significantly endangered their position, especially in the case of the euro area. On the other hand, fast-growing markets, especially the BRIC countries (Brazil, Russia, India, China) not seriously affected by the crisis which has created a good basis that positive trends in their development continue, even in a negative environment and despite the crisis, strengthen their position in international economic relations.

One of the best measures of these changes is the share of merchandise trade (exports and imports) to GDP. For rich nations, the increase was from 35.4% in 1980 to 52.5% in 2008, before the recession severely impacted trade flows. But for middle and lower income developing countries, the increase was even greater, from 34.2% to 55.6%. Not surprisingly, China and India set the pace.

---

<sup>1</sup> FEFA, University Singidunum, Belgrade, savric@fefa.edu.rs

<sup>2</sup> FEFA, University Singidunum, Belgrade

China's merchandise trade to GDP ratio nearly tripled from 20.1% to 56.7%, while India's multiplied from 12.8% to 42.5%. While there were some exceptions in sub-Saharan Africa and Latin America, and among war-torn nations, the data demonstrate the impact of the globalization process. (Eckes, 2011, p. 83)

Furthermore, global trade has been advantageous to advanced countries supplying them with imports of manufactures at low cost. Losing much of their „old“ industrial base, the United States, Europe, and Japan have, in turn, been refocusing their economies on high-tech, information technology and on services. Capital flows have also swung in new directions. In place of traditional capital flows from the wealthy countries to the poor countries, from West to East, in recent years capital from some developing countries (like China) and the oil producers have financed the trade deficits of the advanced countries in the West (like United States). (Adams, 2011, p.4)

### **Methodology**

For the needs of this paper, the authors conducted qualitative analysis using the Pearson Product Moment Correlation for determination of the correlation between the world gross domestic product and gross domestic product related to observed countries (BRIC countries, EU countries and US). The second correlation was conducted between world export and the volume of exports of already mentioned country groups. This was done in order to answer the question how shift of business focus on the fast-growing countries affects the dynamics of trade and investment flows as a key driver of development.

Pearson's Correlation Coefficient (Product Moment Correlation), denoted by  $r$ , is an index without dimensions that takes on values ranging from -1.0 to 1.0, including these values, and it reflects the spread of linear correlation between two sets of data. If variables are not correlated,  $r$  is zero. When higher values of the independent variable  $X$  correspond to the higher values of the dependent variable  $Y$  and vice versa (by decrease in the values of the independent  $X$ , the values of the dependent  $Y$  also decrease), it is a positive correlation ( $r > 0$ ). Otherwise, when higher values of the independent variable  $X$  correspond to the lower values of the dependent variable  $Y$ , and/or when values of the independent  $X$  decrease while values of the dependent  $Y$  increase, it is a negative correlation ( $r < 0$ ). The general rule is: if the value of the coefficient of simple linear correlation is closer to 1, the interdependency between the observed phenomena is stronger. The correlation coefficient never has the values 1 or -1, as it would mean that between the variables there is a mathematical and not statistical relationship. For the calculation of Pearson's Correlation Coefficient, there must be two sets of data. The following model is applied:

$$r_{x,y} = \frac{N \sum XY - (\sum X) \cdot (\sum Y)}{\sqrt{[\sum X^2 - (\sum X)^2][N \sum Y^2 - (\sum Y)^2]}}$$

where  $r$  represents a symbol for Pearson's Correlation Coefficient,  $N$  a number of cases, the summation of products obtained by multiplying the data from columns  $X$  and  $Y$  from each row, sum of data from the variable  $X$ , sum of data from the variable  $Y$ , the squared sum of data from the variable  $X$  and the squared sum of data from the variable  $Y$ .

**Fast-growing markets**

Emerging economies are low-income, rapid-growth countries using economic liberalization as their primary engine of growth. They fall into two groups: developing countries in Asia, Latin America, Africa, and the Middle East and transition economies in the former Soviet Union, East Europe and China.

The emerging power and influence of the BRIC countries (BRICs) underscored a fundamental transition in the global economy. Moreover, the four rising powers were only developing countries but they were rich in potential. They represented 42% of the world’s population, and generated 24% of world GDP in 2009, up from 12.9% in 1990. By mid 2010, the four BRICs had nearly \$3.5 trillion in monetary reserves, 72% more than Canada, the US, Japan, the euro area, and the UK combined (\$2.04 trillion). Except for Russia, the BRICs had avoided serious distress during the 2007-2010. (*The World Bank Annual Report, 2010*)

Having combined labor force of more than 1 billion people, BRICs have always had the potential to be key players in the global economy. Furthermore, rapid economic growth in recent decades has enabled BRICs to begin to tap this potential. With a large population base and relatively low per capita income, role of this group of countries in the world economy, is likely to increase over time as they narrow their gap with advanced countries in income levels.

The world population in 2011 was estimated to be 7 billion people. Almost three out of every seven people in the world today live in BRICs. Although the share of these countries in world population is projected to decline over time, similar to that of the United States and the Euro Area, it will remain a multiple of that of the United States and Euro area combined and could eventually supports economies that are commensurate to BRICs human resource base. (Issouf, Yongzheng, 2011)

Regarding growth, since the early 1990, BRICs have more than doubled their share in global output. BRIC’s GDP (based on market exchange rate) are now the third largest in the world after United States and the Euro area, and according forecasts of the relevant international institutions, BRICs will have an increasingly significant share of the production potential of the world economy despite the early beginnings of the expressed economic growth slowdown in 2012.

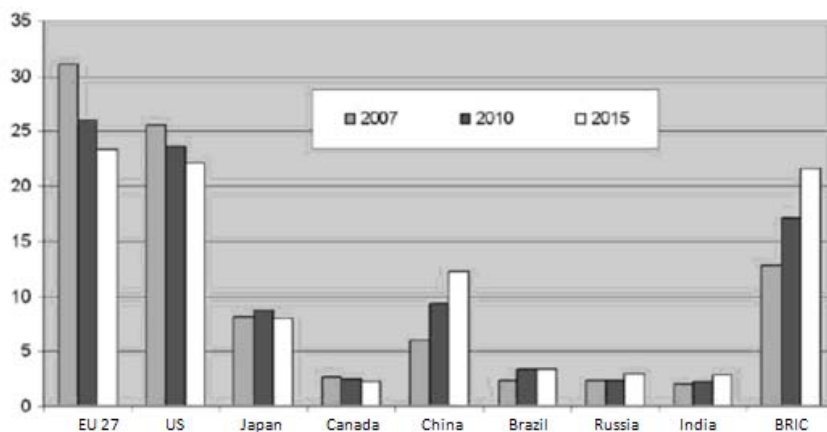
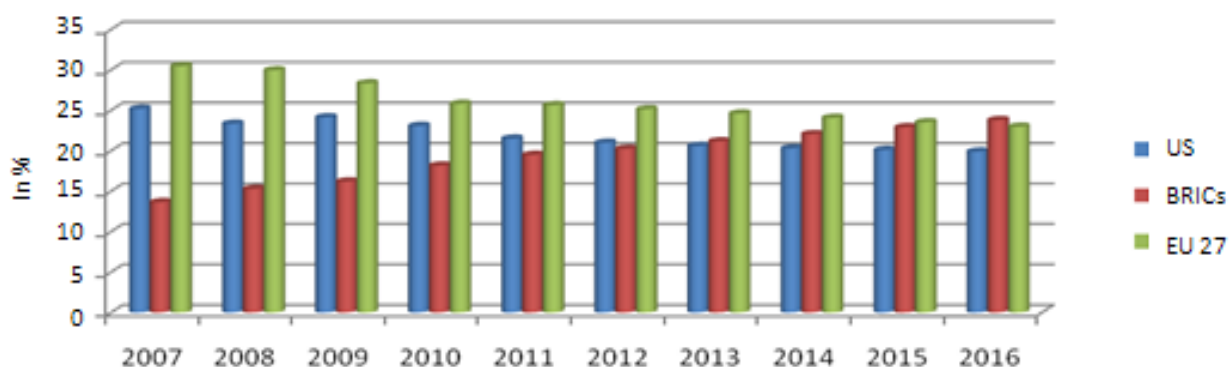

**Figure 1. The share of world's leading economic powers in the global GDP, for period 2007-2015**

Source. IMF, World Economic Outlook Database 2011, *World Economic and Financial Surveys*, Washington DC

## THE CHALLENGES OF POST CRISIS GLOBAL DEVELOPMENT – ROLE OF FAST GROWING MARKETS

Current economic crisis, which many consider the most serious economic earthquake since 1930, did not seriously slowdown economic activity in BRICs. With the exception of the 2009 when the economic activity of fast-growing markets stagnated (IMF: *World Economic Outlook Database, 2011*), throughout almost all the crisis period those countries marked the high GDP growth rate. In the period 2001-2010 BRICs have doubled their share of global GDP (from 7% to 14%), and in the next 2013 this group of fast-growing economies should reach a fifth of total world economic activity. Unlike them, economies of developed countries affected by recession will grow, compared to the level of activity in 2007, by only 10% which indicates the kind of redistribution of power at the world market.



**Figure 2. Current and planned movement of the share in total world GDP (economic power of BRICs, US and EU)**

Source. IMF, World Economic Outlook Database 2011, *World Economic and Financial Surveys*, Washington DC

There are used two correlations to confirm the evidence presented. Each data series contains a time interval from 2002 to 2011. The first one measures the degree of correlation between the GDP of the studied groups of countries and world GDP. The aim of this correlation is to present contribution of the EU, the BRIC and the developed countries (speaking through the United States) to world GDP. Another correlation observes degree of correlation between the export of the same group of countries, and world exports.

Results of the analysis clearly show that the strongest correlation is between world GDP and BRICs. This confirms statements from the paper, BRICs are the most involved and give the biggest contribute to the world economy development. R squared indicator shows how to match the movement of these values. As it has already been mentioned in methodology section, when coefficient is closer to 1, the relation is stronger. Therefore, the conclusion is that the movement of world GDP can be predicted, with a high degree of safety, by the movement of BRIC's GDP.

Regarding exports, there is a 100% correlation between world and US exports. Also, strong correlation is observed between the world's exports and total exports of EU countries. These findings indicate that the developed countries still account for a large share of world exports. Current crisis has slowed their export growth rate, however their influence is still great. As it has already been mentioned in the paper, advantage of the fast growing market is that they have managed to maintain remarkable growth rate even in crisis periods. In the analyzed cases, movement of the world exports can be predicted by movement of US exports and vice versa.

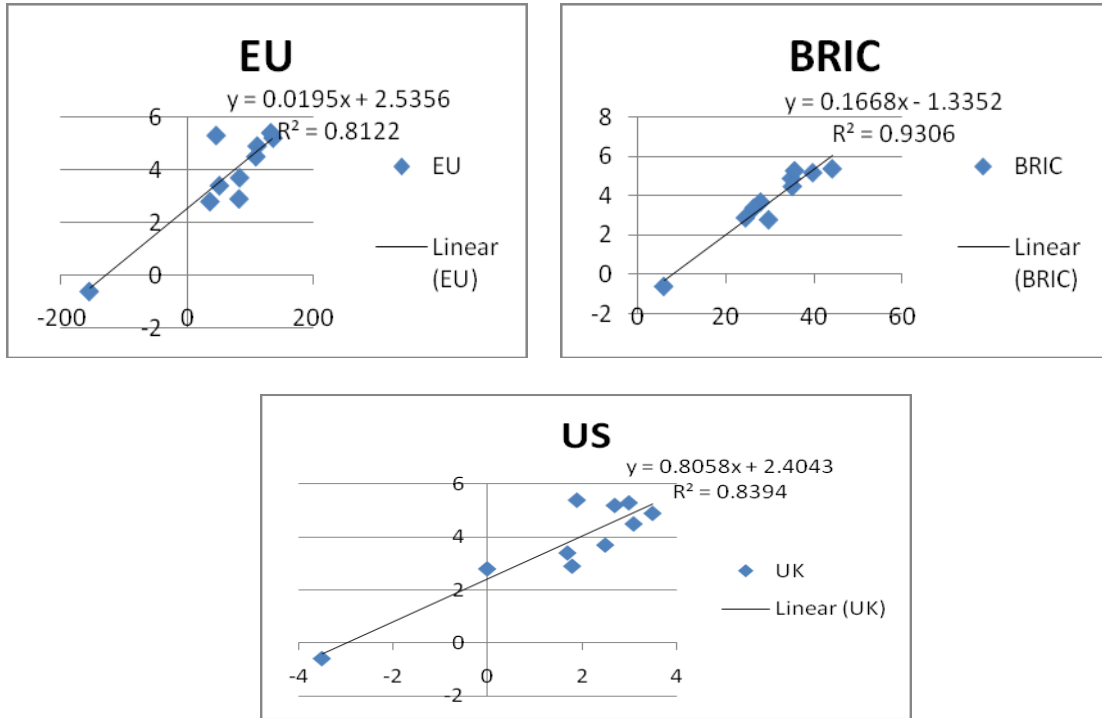

Figure 3. Correlation between world GDP and GDP of BRICs, EU countries and US

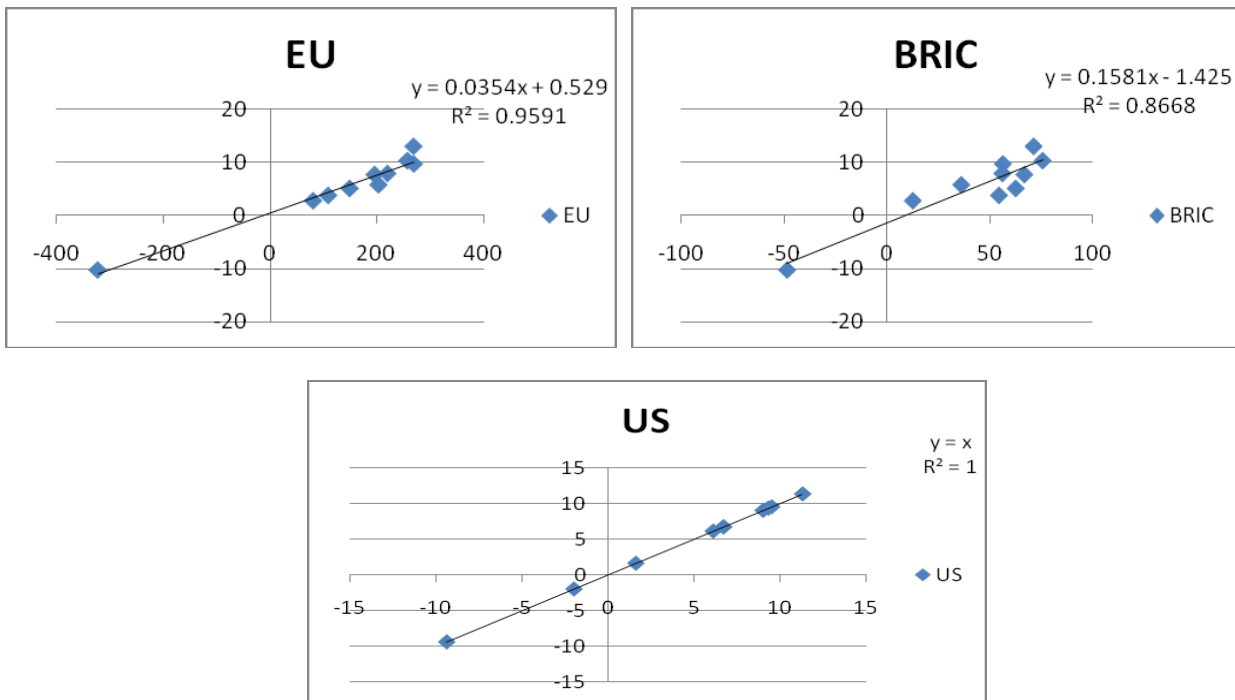
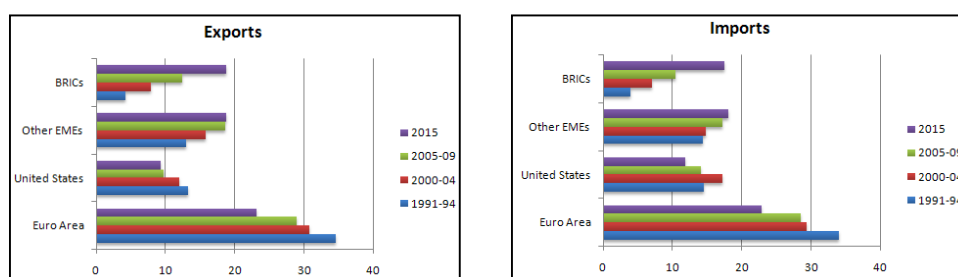

Figure 4. Correlation between world export and export of BRICs, EU countries and US

Regarding trade position, BRICs exports have been the most dynamic in their integration into the world economy. Over the past two decades, BRICs share in world exports has nearly tripled, overtaking that of the United States and catching up rapidly with that of the Euro area. The growth of BRICs imports has been less spectacular but still very impressive (nearly doubling their share in world imports over the past two decades and should catch up with the United States soon). (Issouf, Yongzheng, 2011, p.7)



**Figure 5: BRICs in the global economy, 1991-2015**

Sources: *IMF and World Economic Outlook, October 2010*

Finally, investment focus move to emerging markets has made their economic development more dynamic, both strengthening trade position and greatly sharpening the competitive environment in these markets. According to latest UNCTAD report (*UNCTAD Report, 2011*), BRICs (including and South Africa) were among the biggest recipients of greenfield investments in period 2005-2011. Moreover, this equally applies to the value and to the number of individual greenfield investments. Number of investments ranged in South Africa from 29 to 65, in Brazil from 34 to 102, in India, which is recorded with China, from 191 to 358, in Russia from 133 to 192 and in China from 141 to 330 of individual investment.

Recent research conveyed by the World Bank related to the profiles of countries according to certain indicators connected to the attractiveness of foreign investment such as the ability and the safety of investments in certain sectors, indicate that the profiles of BRICS countries are above average and recommending them for foreign direct investment (FDI) in the following period.

### **Developed economies vis-à-vis fast growing economies - who gains and who loses**

Most economists agree that in the last ten years, especially in the period of economic crisis, key drivers of global economic development were fast-growing markets (BRICs), rather than the established economies like the Triad countries. BRICs turned from passive observer of world economic developments into active participants due primarily strengthening of their trading position and the positive impact that exports had in their dynamic economic growth.

Significant energy supplies (Russia and Brazil), cheap labor force and low production costs (China, India and South Africa) are key pillars for improving their export, and hence their economic development. As Krugman (2009) points out, the role of the different rationales for trade, comparative advantage, and different factor endowments compared to increasing returns and product differentiation has varied historically and will continue to do so in the future. The basis for today's trade, mass-produced manufactures like clothing and hoses, and automobiles and electronics increasingly originating in East Asia, remains a comparative advantage, reflecting the relatively low labor cost in

the exporting countries, now increasingly father „East“; that is, in China. As trade barriers were lowered, as transportation and communication costs have declined, and as skills were acquired, the scope of the market expanded geographically. (Krugman, 2009, p.561-71)

Globalization has not yet wiped out the huge cost differentials between advanced and emerging countries. That may last for a while longer; but surely, as the world becomes increasingly globalized, the differentials in resource costs, particularly labor cost that have supported world trade will disappear. Looking to the future, the disparities in incomes (and costs) between the „old“ industrial countries and the „new“ will gradually fade as the emerging economies catch up with the more advanced ones. At that point, trade will still be taking place, but it will no longer be a reflection of comparative advantage but of the increasing returns and product differentiation phenomena that lie behind the new economic geography. Moreover, specialization and agglomeration will be the dominant basic for trade, and hence for economic development in a more fully globalized world economy. (Adams, 2011, p. 200)

### **Conclusion**

The geopolitics related to future world is not yet clear. Which country(ies) will be the dominant economic power(s) later in the 21st century? Power and influence are often thought to be related to the size of a country's economy, though other factors also make an important difference. The role of the European powers has declined significantly. The United States appears still to be the world's most influential, but, as globalization goes on, other countries are having more important roles in the world economy. (Adams, 2011, p. 201). Results of the analysis confirm this conclusion. They clearly show that the strongest correlation is between world GDP and BRICs. This also confirms hypothesis, BRICs are the most involved and give the biggest contribute to the world economy development. Also, the movement of world GDP can be predicted by the movement of BRIC's GDP with a high degree of safety. Even stronger correlation is between the world export and export of BRIC's. All this results together, show importance of fast-growing markets for world economy.

Trends in economic growth related to larger developing countries, particularly China and India, suggest that the future may be very different from the past despite signs of slowing down the dynamics of growth in China (forecast growth in 2012 was adjusted to 7.5%). Many of the major Asian economies are increasingly dependent on China as a trading and investment partner, so consequently, the slowdown in China could have a negative impact on them too. However, China is expected to strengthen its market reforms and intensified export representing the backbone of its economic growth in the future. According to some forecasts, equally important role will have economic forces known as "second order" (Mexico, Indonesia and South Korea) which have already contributed a quarter of world GDP. Doubtlessly, the 21st century will be the century of greater role of Asian countries, especially the greater role of fast-growing countries at the international market.

### **Acknowledgments**

This Research Paper was part of the project “Advancing Serbia's Competitiveness in the Process of EU Accession”, no. 47028, in the period 2010-2015, financed by Serbian Ministry of Education and Science.

## References

- Adams, G. (2011). *Globalization, today and tomorrow*. Routledge Taylor&Francis Group, London and New York.
- Claessens, S. and Schmukler, S. (2007). *International Financial Integration through Equity Markets: Which firms from Which Countries Go Global?*. World Bank Policy Research Working Paper 4146, World Bank, Washington, DC.
- Cooper, R. (2008). *Global Imbalances: Globalization, Demography and Sustainability*. Journal of Economic Perspectives 22(3):93-112.
- Dutt, A. (2005). *International Trade in Early Development Economies*. Development Economies, New York Zed Books, 107-11, 120.
- Eckes, A. (2011). *The Contemporary Global Economy-A History since 1980*. Wiley-Blackwell, A John Wiley&Sons, Ltd. Publication
- Fallows, J. (2009). *Postcards from Tomorrow Square: Reports from China*. New York: Vintage.
- Goldman Sachs Group (2010). *Is this the 'BRICs Decade'?*. The Goldman Sachs Global Economics, Commodities and Strategy Research, BRICs Monthly 10/03, London.
- Hoffman, D. (2003). *The Oligarch: Wealth and Power in the New Russia*. New York Public Affairs.
- Hunt, J. and Marjolaine G. L. (2010). *How Much Does Immigration Boost Innovation*. American Economic Journal: Macroeconomics 2(2): 31-57.
- IMF, (2011). *World Economic Outlook Database 2011*, World Economic and Financial Surveys, Washington, DC.
- IMF, (2011b). *Low-Income Countries' BRIC Linkage: Are There Growth Spillovers?*. IMF Working Paper 11/267, Washington, DC.
- IMF, (2010). *Rebalancing Growth*, World Economic Outlook IMF Report, Washington, DC.
- Issouf, S. and Yongzheng, Y. (2011). *Low-Income Countries' BRIC Linkage: Are There Growth Spillovers?*. IMF Working paper, WP 11/267.
- Krugman, P. (2009). *The Increasing Returns Revolution in Trade and Geography*. American Economic Review 99 (3): 561-571.
- Mawhinney, M. (2002). *Sustainable Development- understanding the green debates*. Sustainable Cities Research Institute, University of Northumbria at Newcastle, Blackwell Science Ltd.
- O'Neill, J. (2001). *Building Better Global Economic BRICs*. Goldman Sachs Economic Research Group, London.
- Paul van den Noord, Istvan Szekely (2011). *Economic Crisis in Europe- Causes, consequences and responses*, Routledge Albert House, London
- Stiglitz, J. (2006). *Making globalization work*, Penguin Books Ltd, London.
- The World Bank Group (2010). *World Investment and Political Risk*. Multilateral Investment Guarantee Agency (MIGA), Washington.
- Zoellick, R. (2008). *Modernizing Multilateralism and Markets*. Washington Peterson Institute for International Economics. (12 May 2012)
- [www.piie.com/events/event\\_detail.cfm?EventID=86](http://www.piie.com/events/event_detail.cfm?EventID=86)



# GLOBALIZATION AND GLOBAL CURRENCY

Krste Sajnoski<sup>1</sup>

Violeta Madzova<sup>2</sup>

**Abstract:** *The last financial and economic world crisis and the breakdown, not to say, regression in the development of the processes of globalization, definitely, impose the question of creating the global currency as a priority. It is evidently that the disadvantageous flows in separately developed national economies and international economic relations are a consequence of the absence of world currency i.e. of the functioning of dollar and other national currencies as world money. The bids for “rescuing in the way one can do that” do not give satisfactory results. The achievement of individual efforts is low. The necessary, organized, coordinated and synchronized resolving of global problems asks for establishing the global currency as an objective economic criterion of rational and international division of the labour and for further integration of the national economies into the world economy. The creation of global currency is a prerequisite for the development of more balanced international economic relations and for the improvement of the processes of globalization, on an imperishable basis, in the interest of the development of all countries and of global economy. The existing inconsistent international monetary system (IMS), which is based on the national currencies as world money, has already created global imbalances that cannot be overcome by extending the role of national currencies in the function of world money. The failure of creating global currency will enlarge the danger of protectionism in all countries.*

**Keywords:** *financial and economic world crisis, global currency, globalization.*

## Introduction

The problems in managing to find a way out of the last global financial and economic crisis and the increase in the application of various protectionist measures, to the extent of speaking about the process of de-globalization, unintentionally indicate the necessity of reviewing the conditions under which the objective process of globalization is being carried out. It is clear that the development of productive forces cannot be stopped but whether it will go in an upward line or with set-backs and slumps, largely, depends on the conditions under which it is taking place in separate countries and at a global level. It hasn't been senseless, that after the dissolution of state-planned economies in the countries of the social bloc and their transition to market-oriented economies, 'the end of history' has been announced in the sense that the world, after the victory of the liberal democracy and the market-based economies, has entered into calmer waters where the ideological conflicts and the Cold War have become past. However, the conclusion manifested itself as premature. The latest crisis has shown that the world and the global crisis are far from the end of history, whereas the results that should mark the end cannot be reached if the reasons for the crisis are not perceived objectively and if it isn't shown readiness for their outstripping by the interests of all countries in the world. The globalization can go on only if it provides profit out of the benefits of its free realization for all countries, especially for the majority of each country's population. The globalization that has been carried through neoliberal principles has ended with crisis out of which the economies of the developed countries and the world economy as a whole haven't recovered yet.

---

<sup>1</sup> Faculty of Economics, Goce Delcev University, Štip, krste.sajnoski@ugd.edu.mk

<sup>2</sup> Faculty of Economics, Goce Delcev University, Štip

This conclusion is being indicated by the facts according to which the main reason for the global crisis is the increase in inequality not only in the individual national economies but also between them. Such development reduces the demand both at a national and global level and it affects the interest of increasing the production and employment adversely. This reflects negatively on the efforts to outstrip the recessional flows and to reduce the unemployment, especially in the developed economies. It is a fact that during the pre-crisis period the mitigation of the contradictions caused by the increase in inequality in the developed economies has been carried through the relaxation of monetary and fiscal policy. But that has led to the creation of 'bubble economies' and to their inevitable explosion as a result of the unsustainability of the growth achieved by the already mentioned policies. Therefore, they have only delayed the outbreak of the crisis, but they couldn't prevent it.

Given the fact that the financial crisis first manifested itself in the USA, and then spread out in the other countries, it has rightly been indicated that the international role of the dollar has contributed to the generation of the crisis. It provides an alibi for a more relaxed monetary and fiscal policy of the USA, with a deficit in the current account, in order to maintain satisfactory international liquidity. At the same time it is a reason for the generation of global imbalances (increase in deficits in the USA and in surpluses in Germany, Japan, China and other countries). The 'bubbles' of the relaxed monetary and fiscal policy have burst whereas the global imbalances cannot be resolved anymore by applying 'soft' or 'hard' power at the expense of the surplus economies (as it was the case up to the crisis – with appreciation in the currencies of surplus countries). It has to be looked for a solution in the abandonment from the concept of national currencies for the purpose of world money and in the creation of global currency of the type of commodity money.

This outcome has got its own theoretical and practical foundation in the functioning of the system of gold validity, when the process of globalization, even at a lower level of development of the productive forces, has reached culmination. It is not a coincidence that several decades after the elimination of the gold of the International Monetary System (IMS), it has been arisen the need for global currency for the development of global economy. Obviously, it doesn't come down to the return of gold validity, but to the creation of system that would simulate the rules of functioning of gold validity. That is a key assumption for resuming the process of economic globalization (through the movement of goods, services, capital, knowledge and labour force), perceived as a constant integration of the economies around the world, on the basis of objective economic criteria.

There is key understanding within the elaboration of the title's theme about: a). what a global currency is, b). how it has happened for the national currency of the USA (later on and the currencies of other countries as well) to function as world money, c).the way in which such functioning has contributed to the creation and outbreak of global financial and economic crisis and d).what type of global currency can affect the mitigation and what type cannot affect the elimination of global imbalances.

### **Commodity money as a global currency**

The evolution of money as a commodity has ended in the functioning of coin monetary system, known as a system of gold validity, the gold being a general equivalent to the commodity values. It comes down to a complementary system that functioned simultaneously as national and international system of payments. In this system, the commodity money i.e. the gold functioned as a measure of values and measure of prices, a trading means, a circulating medium, a means of saving money and as world money. The relation between the national currencies, whose value was set in certain amount of gold, was determined as a ratio of their golden parities. The parities were kept stable, meaning that the rates of their currencies were stable. The banknotes were convertible into gold.

An assumption about the functioning of the system was the liberalization of relations towards abroad being expressed in the freedom of import and export of gold and the free functioning of the market legalities in the national economies expressed in the freedom of smelting and forging gold. The functioning of the system prevented the occurrence of permanent surpluses and deficits in relation to the other national economies. The insistence on avoiding the outflow of gold while having an obligation to maintain the stability of currency rate meant that it was expressed a preference for the external stability of economy. The convertibility and stability of exchange rates extorted a struggle for increasing the productivity and thriftiness in the national economies.

The positive effects of the functioning of the system of gold validity were due to the internal real value of the golden money i.e. of the convertibility of banknotes into gold through a fixed parity even in the national economies and in the inter-currency relations of the countries of gold validity. In fact it was a system of commodity money. Its functioning permitted balancing in the development in separate national economies and between them under the market criteria of profitability. That was the basis for achieving a rational international division of labour in the world economy.

The striving to respect the rules of functioning of the system of gold validity has issued from the importance of the money within the reproduction in each national economy, including the segment of its international economic relations. Whereas within this segment, by using gold as money (in the internal and international relations), the institute – money (“as cultural and economic phenomenon, (Meichsner, 1958)) *effectuated* most completely and very successfully all the functions of money, taking into consideration the quicker development of individual countries and of the world as a whole, in regard to the preceding periods.

Gold used as money carried out smoothly all the functions of the money (a measure of values, a measure of prices, a trading means, a circulating medium, amassing a fortune and world money). With the fixed parities, the system of gold validity imposed a unique criterion for rational functioning of the international division of labour, necessary for effective development of the national economies and the world economy as a whole. This is in fact the advantage of commodity money in relation to the national currencies as world money, especially in terms of the paper money systems and floating exchange rates in the inter-currency relations in the world. The first express the relations of commodity values worldwide, whereas the latter express only the relations of commodity values between individual national economies and the economy of the country whose currency functions as world money. In this context, it is obvious that the instability of rates prevents the rational international division of labour and the objective process of globalization<sup>3</sup>.

There is no doubt that the attractiveness of the systems of gold validity comes to the fore even through the possibility of penetrating of the mutual demands of separate countries i.e. the payments to be made by real money (or in gold). That is a warranty for real valorizing of the international commodity transactions.

The differences between the international system of gold validity and the system of dollar standard are often brought down to the fact that the point is, on one hand, the coin monetary system and on the other hand, the paper money systems. That is true, but these are characteristics which do not express their essence. But their essence is such that they cannot be compared since they fall into different categories. Gold validity is in the sequence of the system of commodity money as world money, whereas the dollar standard is in the sequence of national currencies as world money. While the functioning of the system of gold validity can be simulated and practiced even as a paper money system, having all the benefits that rise out of the circulation of commodity money, it cannot be believed that any solution relying on national currencies can contribute to the further development of international economic relations in the direction of further globalizing on market principles because of the reasons for abandoning the fixed parities.

---

<sup>3</sup> Keynes said long ago that there is nothing worse than irrational investment.

The similarity of the two systems is that the key assumption for their functioning is the liberalization of the economic relations of national economies abroad, which is not brought into question within the system of gold validity (it is inherent to the system), whereas within the system of dollar standard, there are taken measures to protect the national economies in separate countries because of the floating rates and different rates of inflation. As a result of that the relations between separate countries are being tighten up to threats of breaking out currency and trade wars.

From the said till now, it follows that from the establishment of the system based on commodity money, it is drawn a greater stability in every national economy and in the international economic relations, whereas the game rules prevent the problems in separate national economies from presenting themselves as world problems.

### **The evolution of the dollar into global currency**

There are two characteristic periods in the evolution of the dollar from national into world currency even though there can be differentiated and sub-periods. The dollar was a national currency in the three forms of the system of gold standard (gold specie standard, gold bullion standard and gold exchange standard). That means that it functioned according to the rules of gold validity and incidentally it maintained a stable gold parity.

There was a reversal of the evolution with the constitution of the Bretton Woods International Monetary System after World War II. Although this is a commodity money system of the type of gold exchange standard, setting down gold parities of the national currencies, according to which are determined the exchange rates in the inter-currency relations in the world, it has allowed naming of the parities because of the fundamental imbalance of national economies.

The countries could set down their currency parities in gold or dollars being convertible into gold. And everything would have been according to the rules of gold exchange standard, but the Americans brought a unilateral decision to replace dollars with gold at a fixed price of \$ 35 an ounce. Even though the price is not necessary for the functioning of the gold exchange standard (but it is the quantity of gold set by the gold parity), it allowed the dollar to function as a currency being convertible into gold, longer than it could have functioned objectively considering the quantity of gold reserves. That move enabled the dollar to function as gold. But that happened until the dollars were really convertible into gold. When the dollar demands outstripped the gold reserves of the USA, there was made a change of the gold parity of the dollar, whereas in 1971 President Richard Nixon revoked the obligation of exchanging the dollars into gold at a new fixed price, and permitted the dollar rate to form itself according to the supply and demand of stock exchange – it was started practice of floating rates of inter-currency relations in the world. Thus the gold exchange standard changed into pure dollar standard. Based on the acquired position, paper dollars continued to function as world money, but with all disadvantages of paper currency and under conditions of floating exchange rates.

By abolishing dollar-to-gold convertibility and abandoning fixed exchange rates in the inter-currency relations in the world, the U.S. currency abandoned its relation with the world commodity values (whose representative was the gold) and it was brought down to an equivalent of the U.S. commodity values, but it continued its function as world money and started the practice of national currencies in the function of world money. Thus, the benefits of the global commodity currency were disrupted in all money functions and it was contributed to the development of the internal imbalances in the U.S. economy and to the development of global imbalances (which manifested themselves into currency and trade crises). And as a result of such development of relations, the biggest financial and economic crisis took place after World War II.

**The need for international liquidity – alibi – reason for relaxed monetary and fiscal policy i.e. for building up the huge deficits and “bubbles”**

Although it is not often emphasized that the latest crisis is a consequence of the international role of paper dollars i.e. of the non-existence of global commodity currency, it clearly issues from the following of causative-consecutive relations of the events before the crisis, during the crisis and in the insistencies on outstripping it. Even if the most superficial reason – deregulation of financial system and relations, associates itself with the purpose of intensifying the processes of globalization, it expresses after all the need for the expansion of financial capital in the world. The crisis manifested itself by bursting the “bubbles” of real and financial assets. But, the reason for inflating the “bubbles” is the need to outstrip the inequalities generated by the system of reproduction with the purpose of avoiding the possible social tensions. The relation between the financial globalization, inequality and raising of public debt is proved empirically (Azzimonti, 2012).

In this context it is not even mentioned the need for satisfying the international liquidity as alibi-reason for relaxed monetary and fiscal policy of the USA by which it is implemented the building up of huge budget deficits and foreign debt. Long ago, even for the system of gold- dollar standard, it was noticed that in order to meet the need of international liquidity, the USA should lead a deficit policy on the current balance (Robert Triffin). However, by increasing the level of foreign indebtedness, it is brought to question not only the stability of the national economy but also the stability of the international economic relations, provided that the amount of emitted dollars is above the objective needs of the American and world production of values. But, that was happening most often after the abolition of dollar-to-gold convertibility.

Under conditions of functioning of the international system of dollar standard, the international instability, which was used as a valve for mitigating the internal contradictions, led not only to their tightening but also to tightening of the relations between the national economies (currency crises, protectionism, threats of currency and trade wars, global imbalances, financial and economic crisis). The use of the excessive privileges of dollar position generated even high foreign instability of the country. But the problems in the efforts to outstrip it lead to a conclusion that both the internal and global imbalances cannot be permanently outstripped unless there are carried out fundamental reforms in MMS, without establishing a global commodity currency being released from the influence of the national currencies. Only by functioning of the world currency of the type of commodity money, the unacceptable situation can be outstripped, and the national problems can be treated as world problems because of the risks of possible confrontations.

Here it should be taken into consideration that the obligation for satisfying the international liquidity was a good alibi for leading a relaxed monetary and fiscal policy resulting in huge deficits. Besides that, it does not matter whether the international role of the dollar is a reason for leading such policies or the interest in conducting such policies (mitigation of the inequalities within the country, through inflating the housing bubble, including the interest in using the opportunity for an inflow of foreign loans without interest) has lead to internal imbalances in the USA and to global imbalances. In both cases it is shown the inadequacy of the national currencies in the function of world money. It becomes more and more evident that such imbalances cannot be outstripped, and the objective process of globalization cannot proceed successfully without generating a market-consequent international system i.e. system with a global currency of the type of commodity money.

### **Global currency of the type of commodity money**

There are more suggestions of creating a global currency in the literature. Some are on the line of returning to the evolution of money as a commodity whereas others, through reforming MMS, are trying to codify the constant practice of national currencies as world money. The first suggest a global currency of the type of commodity money, and the latter strive for continuing the permanent practice, despite the problems generated by that practice, bringing into question the continuation of the processes of globalization based on market principles. The first are for thorough reforms of MMS, and the latter for sanction of the permanent practice, which generates internal imbalances in the countries with currency that plays an international role and role of global imbalances.

The supporters of the creation of global currency of the type of commodity money consider that by eliminating the national currencies in the function of world money, it will be contributed to accomplish the other objectives of the reform of MMS which have been emphasized for a longer period (Montbrial, 1974):

- to establish a system that will not allow a creation of imbalance and will not create obstacles in the development of trade exchange;
- to establish a system that does not emphasize any monetary characteristics. In particular, the international reserves should not depend on the national currency. All countries should have the same rights and the same obligations;
- to look for a reserve instrument: a). whose volume rises in terms of the development of international exchange, b). that will not impede the independence of the countries and c). that will not be inflationary;
- to put into effect a mechanism in order to prevent the anarchic flows of the short-term capital that constantly brings into question the parities;
- it is desirable for the new international monetary system to keep an account of the interests of the developing countries.

The accomplishment of the objectives mentioned above is a good basis for avoiding the disintegrating processes and for tightening the international economic relations in the direction of their globalization. And the further evading of the need for abandoning the national currencies in the function of world money is “raping” of the process of globalization that cannot be expected to bring forth well. That leads to blind alleys in the development of globalization and prevents it from being realized as a whole, as an interest of all national economies, out of which all countries and the majority of their population will have benefits.

Within the solution of creating global currency of the type of commodity money, there are theoretically possible the following forms of global currency (Shajnoski, 2010):

- a return of the gold validity;
- an establishment of a system and relations where paper world money would be emitted, as the national paper money of forced validity are emitted in the national economies;
- a creation of a world currency whose value would be determined in one or more commodities (similar to Keynes’s *bancor*), and the value of the national currencies would be determined in terms of the value of world currency.

With the other models, it is carried out the practice of the functioning of national currencies as world money, even when it is thought of the world money unit as a basket of several more important national currencies. In this context, the story of SDR is interesting. Although they were defined as world paper gold, they shared the fate of the gold exchange i.e. gold-dollar standard in that respect that

they did not develop as paper gold because not even the dollar itself could be gold, so they ended as a money unit whose value is determined by a weighted value of several national currencies.

It follows from the former elaborations that the permanent solution in relation to the establishment of global currency should be sought in the consequent continuation of the process of dematerialization of money that was started long ago and has been finished by now in the national economies and at a world level. Besides that, due to the need of gradualness of the development (because of the non-existence of supranational institutions), it is still on-going Keynes's proposal for emission of bancors (as a world money unit) whose value would be determined in gold. This idea develops itself even in a global currency whose value would be determined in a basket of more commodities. It is crucial that it is sought for the international needs of trade to be created a global currency through which, with fixed but adjustable rate, the national currencies would be related. The global currency would be just a step to the next unique world currency of forced validity, as a manifestation of the increased harmony of international relations i.e. of the high process of globalization.

There are seen solutions in the proposal of creating bancors for both the internal and foreign imbalances.

"Keynes anticipated the current problems of global imbalances. With this proposal he wanted to create a system in which there would not be generated surpluses and deficits by anybody. Under this system, the export would earn bancors, and the import would spend them. The point was to keep them both into balance, so that at the end of the year the accounts of the countries with ICU (International Clearing Union) would be neither in surplus nor in deficit, but "cleared" - close to zero. Every country would be assigned a fixed, but adjustable exchange rate relative to the bancor. Keynes's original thinking perceived that the nations with too many bancors would disrupt the system as much as those with too few – that the creditors would be as dangerous for the stability and prosperity as debtors (George, 2007). In this sense, Susan George rightly considers that the method of equilibrating the balances suggested by Keynes was and is brilliant, especially from the aspect of the current conditions when it threatens a trade war between deficient USA and surplus China. This is a comprehensive solution that puts simultaneous pressure both on the country-creditor and on the country-debtor to clear their accounts<sup>4</sup>(Skidelsky, 2005).

Although it is difficult to talk about "if wishes were horses, beggars would ride", there is no doubt that the functioning of global currency of the type of commodity money:

- would release the world from monetary crises including more national currencies,
- the inflation would be above all a national problem,
- there would not be so large disharmonies in the development to negotiate for balance between separate countries, with requests for changing their national strategies of developing,
- there would be no fear what a country could do with its own currency, because the consequences of the establishment's relation to it would be tolerated by the country's individuals, and they would be punished if they conduct inefficient and irresponsible economic policy.

It is obvious that Keynes's proposal eliminates the privileges of any currency i.e. of any country. He insists on establishing a principled solution in accord with the essence of money and with their significance for the further development of world economy. It is crucial that the proposal

---

<sup>4</sup> The Bretton Woods Agreement is based on the Orthodox Doctrine of adjusting the debtor, considering that the Americans knew that as creditors they will definitely adjust themselves. "The USA have poured out their surpluses in order to help the reconstruction and liberalization of Europe and Japan after the war, as well as to protect them from Communism, starting with a deficit of their balance of payments".

corresponds to the logic of the development of money in the function of intensifying the objective processes of globalization.

It doesn't wash the argument against the unique global currency in that sense that the idea is impracticable given the huge differences existing in the national political and economic systems. It's not that there is no truth in this, but they should not be an obstacle if the world determines and transfers itself on that track. Moreover, just prior to the crisis, it was considered that the processes of globalization were moving forward, with national currencies in the function of global currencies. Why would there be a problem they not to continue to be promoted under conditions of the functioning of global currency? The unique global currency is more an assumption of their achievement rather than an argument that evades even the discussion about it, despite the problems created by the functioning of the national currencies in the role of world money.

It is pure irony the thing that happened to the USA. They evaded Keynes's plan which predicted the nations – creditors to accept a greater responsibility for solving the imbalance of international payments, and nowadays they are fighting with all the forces to impose that obligation on the surplus countries, by fair means or foul, instead of leading the changes of the international system of payment in the direction to divide the responsibility among the deficient and surplus countries (*Joseph Stiglitz notices that John Maynard Keynes pointed out that the surpluses lead to weak global overall demand (Is there any relief for the euro?, Morning Newspaper, 10. 05. 2010).*

Paul Davidson points out that Keynes considered that the essential promotion to the building of any international system of payment requires transfer of the burden of adjustment from the debtor to creditor. This transfer would replace the contracted with expansionist pressure on the world trade. In order to reach the golden era of economic development Keynes proposed combining the fixed, but adjustable, system of exchange rates with a mechanism that requires the nation "enjoying" favorable balance of trade to initiate most of the necessary efforts in order to eliminate this imbalance whereas the indebted countries to maintain discipline enough in order to prevent the new concession, they are being recognized, from exploitation (Davidson, 2008).

### Conclusion

The causative-consecutive relations of the biggest global financial and economic crisis point out that the national currencies, no matter if it's the dollar, cannot function adequately as world money. The practice has shown that in such a system, with the opportunity of conducting a relaxed monetary and fiscal policy (justified by internal and foreign reasons), are created imbalances not only in the national economy but also within the framework of world economy. The latest crisis and the difficulties to be outstripped are evidence that the monetary system, with the dollar i.e. the national currencies in the function of world money, not only sapped the positive effects of its functioning, but it also became a serious obstacle to achieving both the U.S long-term interests and the interests of the other national economies. The worst is that the objective processes of globalization, as a basis for outstripping the crisis and the potential imbalances permanently, have been endangered. The process of globalization is inevitable. However, it can continue provided that the conditions, which accomplish and allow the benefits of the globalization to be enjoyed by all countries and by the majority of population of individual countries, change themselves. Such conditions are not created in a system in which the national currencies play an international role. It can be less expected the mentioned objective to be achieved in such conditions. The achievement of the conditions and the objective is in correlation with the establishment of global currency of the type of commodity money. And only with such a currency the world can release itself from the national problems becoming world problems.



## References

- Anderson, B. (1944). *Gold versus Bancor or Unitas*. delivered before the Chamber of Commerce of the State of New York.
- Cohen, B. (2010). *Beyond the Dollar-Rethinking the International Monetary System*. A Chatham House Report.
- Davidson, P. (2008). Reforming the World's international money. Paper for conference *Financial Crisis the US Economy and International Security in The New Administration*. The New School, New York.
- Isard, P. (2004). *Globalization and the International Financial System, What's Wrong and What Can Be Done*, Cambridge.
- George, S. (2007). *Alternative finances: The world trade organisation we could have had*. Le Monde diplomatique-English edition. ([www.mondediplo.com/2007/01/03economy](http://www.mondediplo.com/2007/01/03economy)).
- Greenwald and Stiglitz (2008). A Modest Proposal for International Monetary Reform. International Economic Association Meeting. Istanbul.
- Meichsner, V. (1958). *Osnovi nauke o novcu*. Skopje: Univerzitet u Skopje.
- Monbiot, G. (2008). *Keynes is innocent: the toxic spawn of Bretton Woods was no plan of his*. Gardian.
- Montbrial, T. (1974). *Le desordre economique mondial*. Calmann-Levy.
- Mundell, R. (1997). The international Monetary system in 21<sup>st</sup> Century: Could Gold Make a Comeback?. Columbia University. ([www.robertmundell.net/SantaColombaConferences/SCConf.asp](http://www.robertmundell.net/SantaColombaConferences/SCConf.asp)).
- Mundell, R., Exchange Rates. Currency Areas and the International Financial Architecture-[www.usagold.com/gildedopinion](http://www.usagold.com/gildedopinion).
- Schmitt, B. (1973). New Proposals for world monetary reform.
- Skidelsky, C.R. (2005). Keynes, Globalisation and the Bretton Woods Institutions in the Light of Changing Ideas about Markets. *World Economics*, Vol.6. No.1.
- Stiglitz, J., New World monetary system inevitable. ([www.ajc.com/opinion](http://www.ajc.com/opinion)).
- Report of the Commission of Experts of the President of the United Nations General Assembly on Reforms of the International Monetary and Financial System (2009). New York: United Nations.



# INTRODUCTION OF COMPREHENSIVE PERSONAL INCOME TAXATION AS A POSSIBLE WAY TO IMPROVE TAX SYSTEM IN SERBIA

Stevan Luković<sup>1</sup>

**Abstract:** *Reform of personal income taxation denotes attractive researching subject, especially since it has been continuously announced by the tax administration and a number of proposals exist that are possible to apply. Contemporary tax theory and practice provides two basic concepts for taxation of personal income: comprehensive and schedular. Besides them, there are a number of alternative taxation concepts, such as combined model, dual income tax, flat tax. In Serbia, combined model is currently operating. It is predominantly schedular, and just in small part comprehensive. This taxation concept has shown a number of weaknesses in Serbia, mainly considering vertical and horizontal equity and level of tax revenues. In this paper an introduction of comprehensive taxation in Serbia is considered, and consequences that implementation of this model could produce as well.*

**Keywords:** *personal income tax (PIT), comprehensive personal income taxation, tax system reform*

## Introduction

Fundamental tax reforms go beyond small changes in tax rates and provisions. They can be confined to one tax, as for instance a value-added tax (VAT) or personal income tax (PIT) base-broadening reform that finances a cut in the statutory rate of the tax, or they can involve a more complex package of tax increases and reductions. Also, tax reforms can be designed to be revenue neutral – either in the first year after implementation or in the following years – or to increase or decrease tax revenues (Brys, 2011).

There are two main concepts of personal income taxation: schedular taxation and comprehensive taxation. Other concepts of taxation, such as mixed (combined) taxation, flat tax or dual income tax, represent combinations of the previously mentioned concepts. Most OECD countries have some form of comprehensive income taxation, but the number of countries which implement flat tax or some kind of dual tax is rising. Serbia, on the other hand, is one of the rare countries that has mixed (combined) type of PIT, with schedular taxation as more important part, while comprehensive taxation is of minor importance.

The comprehensive income tax system taxes all or most labour and capital income less deductions according to the same (usually) progressive rate schedule. Income from labour includes salaries/wages and other remunerations, fringe benefits, pensions, etc. Income from capital comprises dividends, interest, rental income and capital gains. Under the comprehensive income tax system, no distinction is made between income from labour and income from capital. Significant tax allowances, tax deductions and tax exemptions are usually offered, with respect to many criteria (marital status, number of children, age, costs of obtaining income etc.)

This concept of taxation is based on the principles of horizontal and vertical equity: taxpayers with the same level of income are taxed equally and taxpayers with higher incomes are taxed more heavily. Moreover, comprehensive income tax systems make it more difficult to avoid taxes through

---

<sup>1</sup> Faculty of Economics, University of Kragujevac, slukovic@kg.ac.rs

## **INTRODUCTION OF COMPREHENSIVE PERSONAL INCOME TAXATION AS A POSSIBLE WAY TO IMPROVE TAX SYSTEM IN SERBIA**

---

income shifting – in many countries it is profitable to transform higher-taxed labour income into lower-taxed capital income. But with comprehensive system all types of income (should) have same tax treatment. However, implementing a comprehensive tax system implies fairly high compliance and administrative costs (costs of filing tax returns on the taxpayer's side, and costs of checking income status of taxpayers, on the side of tax authorities).

However, in practice, no OECD country has fully implemented a comprehensive personal income tax system. All countries have special tax treatment for certain types of income (fringe benefits, owner-occupied housing, capital gains, pensions...). This lack of neutrality, in turn, increases the compliance and administrative costs, reduces tax compliance and tax revenues and impairs the efficiency and equity of the tax system (Brys and Heady, 2006).

Tax reform should be conducted by considerations of efficiency, meaning that tax system should minimize discrimination in favour or against any particular economic decisions. In practice, that implies building tax system around broad bases and decreasing differences in tax rates that can be applied. Almost all of the tax reforms in the last two decades involving PIT can be seen as rate reducing and base broadening tax reforms (Jagric et al., 2009). Reforms have been driven by the need to provide a more competitive fiscal environment that will encourage investment and entrepreneurship, provide increased work incentives and reduce tax avoidance and evasion. In recent years, governments have unpleasant task to increase their expenditures, on one hand, and to make their tax systems more competitive, on the other hand.

Although PIT systems among EU countries have never been an object of well designed harmonization, several common characteristics can be found (Wolowiec and Sobon, 2011):

1. Placing subjectivity on the principle of residence. Rules on limited (<183 days), and unlimited (>183 days) tax duty.
2. Joint taxation of all incomes obtained by the taxpayer from different sources.
3. The tax is progressive and specific solutions concern different tax rates, types of scales, rules regarding progression and the size of the minimal and maximum rates.
4. Tax burdens are designed to follow inflation through a system of automatic or semi-automatic indexation or through the change of tax brackets.
5. Different regulations are applied to a family income, sale of real estate, assets and investment incomes.
6. In every construction there exists a sum free from taxation.
7. Multiple rebates and deductions exist that are of a stimulative and social character (investment, building and renovation, health, donations).

The aim of this paper is to use these guidelines to assess whether the comprehensive taxation is the appropriate concept of taxation to replace the existing one in Serbia. The rest of the paper is organized as follows. In the first part, some basic characteristics of current Serbian PIT system are given. Also, some of the weaknesses of the current system are discussed because they are the reason why it seems to be necessary to carry out certain type of reform. In the second part, we examine the possible solutions how to introduce elements of comprehensive taxation in Serbian tax system, but also difficulties that may occur during the process. Third part is reserved for specifying potential advantages and shortcomings of the proposed options. Part four concludes.

### **Basic Characteristics of Current Serbian Personal Income Tax**

In Serbia, mixed type of personal income taxation is currently implemented. It is a combination of schedular taxes and annual (complementary) tax that, essentially, has a global character. Schedular

taxation provides a dominant share of PIT revenues, while the annual personal income tax revenue is significantly smaller (mainly because the number of taxpayers is small). This tax system has shown a number of flaws during the time, mainly considering equity problem and the absence of redistributive function. Basic characteristics of taxation of various income forms are shown in Table 1. As it can be seen, various statutory tax rates for different types of income are implemented, ranging from 10% to 20%, while effective tax rates vary from 10% to 16%. Schedular taxation distorts the principle of horizontal equity, because individuals using different tax treatment of various types of income can change their economic decisions to pay less tax. In that way, it is possible that persons with the same income but different income structure do not pay the same amount of tax.

Also, schedular taxation affects vertical equity. As the Table 1 shows, salary is subject only to indirect progression in taxation because the non-taxable threshold exists, so the effective tax rate rises with income increasing, even though proportional tax is in use. Due to the complementary taxation of annual income, the income of individuals who must pay annual income tax is subject to direct progression in taxation (Randjelovic, 2008). However, the progression in taxation is not adequately targeted because the number of individuals who have to pay annual income tax is relatively low (less than 1% of taxpayers are obligated to pay annual income tax). Considering that, most of the labour income is not influenced by progressive taxation in Serbia.

**Table 1: Current Serbian Personal Income Tax System**

Type of income	Statutory tax rate(s)	Statutory deductible costs	Effective tax rate
Salary	12%	Non-taxable threshold of RSD 7,310	10.51% <sup>2</sup>
Income from independent business activities	10%	-	
Income from agriculture and forestry	10%	-	10%
Income from authorship rights, the rights related to authorship rights and the industrial property rights	20%	Standardized costs - 50%, 43% and 34% of gross income	10%, 11.4% and 13.2%
Income from capital	10% <sup>3</sup>	-	10%
Capital gains	10%	-	10%
Income from immovable property	20%	20%	16%
Other income	20% and (10%) <sup>4</sup>	Standardized costs – 20%, 50% <sup>5</sup>	16% and 10%
Annual Income Tax <sup>6</sup>	10% and 15% <sup>7</sup>	Standard deductions <sup>8</sup>	

Source: *Personal Income Tax Law, Serbia*

<sup>2</sup> Calculated for average gross monthly salary of 58,712 RSD (June, 2012)

<sup>3</sup> Including dividends

<sup>4</sup> Only insurance income is taxed at 10% rate without standardized costs

<sup>5</sup> Size of standardized costs depends on type of income

<sup>6</sup> Only taxpayers whose annual income is greater than three average annual gross salaries pay this tax

<sup>7</sup> Progressive tax rates

<sup>8</sup> For taxpayer himself and dependent family members

## **INTRODUCTION OF COMPREHENSIVE PERSONAL INCOME TAXATION AS A POSSIBLE WAY TO IMPROVE TAX SYSTEM IN SERBIA**

---

If we are interested in capital taxation, the tax rate on income from capital (10%) is lower than the statutory salary tax rate (12%), but effective salary tax rates are much lower at low incomes. It is not easy to estimate whether there are enough inducements for high-income taxpayers to try to report their income from labour as income from capital to pay less tax. Additionally, income from independent business activities is subject to a tax rate that is fixed at 10%. This is also the corporate income tax rate, so it can be concluded that there are no incentives to income shifting, if we observe only statutory tax rates.

The Serbian PIT generates relatively low revenue (around 5% of GDP) while VAT, social security contributions and even excise tax are more significant. This fact raises the question what are the chances of PIT to decrease income inequality with such low amount of revenue it creates. On the other hand, schedular approach enables collecting 95% of total PIT revenue on PAYE (pay as you earn) basis, so the taxpayers compliance costs are minimal. Also, only taxpayers who must pay annual income tax have to file tax return.

The previous analysis shows that personal income tax in Serbia suffers from lack of vertical equity because progressivity is not of major importance. If we focus on horizontal equity then we can see that effective tax rates vary depending on type of income, so it is possible to avoid tax by changing taxpayer's income structure. The difference between effective tax rates appears because of standardized costs that exist for almost every type of income. However, taxable income structure shows that labour income in the form of salaries is the most significant part (82%) while all the other types of income account for only 18% of overall taxable income (Arsic et al., 2009). Considering salaries are the main part of taxable income in Serbia, the problem of horizontal equity is probably not substantial.

### **Introducing comprehensive personal income taxation – basic elements**

Implementing comprehensive income taxation in Serbia assumes that most of the basic elements of the current tax system must be modified or even fully erased. These key elements include:

1. definition of a taxpayer (who must pay tax and who is obligated to file a tax return);
2. rules of taxable income calculation (defining types of income that are to be exempt of taxation, deductions to be offered, types of income that would have special tax treatment etc.);
3. tax brackets and tax rates to be implemented;
4. tax credits and tax refunds.

It is of crucial essence to analyse every of the above mentioned components of Serbian PIT before any kind of reform is carried out. In light of that, we provide brief analysis of the above mentioned components.

Taxpayer is almost universally defined as a person who realize taxable income. What part of taxable income is to be taxed depend on whether the taxpayer is resident or non-resident of a certain country. Current Serbian PIT contains clear definitions of resident and non-resident taxpayer. Important question is whether the unit of taxation should be individual, married couple or household members. Most European countries designate individual taxpayer, with a unified tax rate schedule for all taxpayers, while some countries (France, for example) consider households to be taxpayers, with several tax rate schedules, depending on number of household members. Some countries (Germany, for example) apply two tax rate schedules, for single persons and married couples. Although a number of social goals can be achieved through distinction of single persons and married couples as taxpayers, it must be noticed that this element increases compliance and administrative costs. So we think that the

current solution that single persons who acquire income are obligated to pay tax, without any other options, is the optimal solution. Efficiency in taxation is very important component of every change in Serbian PIT, because of low administrative competence and poor taxpayers' understanding of tax legislation. Three or more tax rates schedule would probably do more harm than good.

Calculation of taxable income supposes prescription of legally based rules that every taxpayer must apply to calculate taxable income. At this place, tax authorities must choose how to obtain certain level of vertical equity. Since the beginning of economic crisis, many of EU countries have adjusted their PIT systems. In most cases, the burden of PIT has been reduced for low-income taxpayers or all taxpayers, and in some cases the burden has been increased for highest tax brackets (Cok et al., 2011). The main goal of these approaches is to increase positive effects of income redistribution. In case of Serbia, with respect to negative effects of world economic crisis, it is necessary to ease the burden of economic crisis for low income taxpayers. This can be done by means of offering personal allowance, so some prescribed level of total income does not enter taxable income. Also, in many countries special allowances are offered (usually child support allowance, old age allowance etc.), which take into account family status and other social characteristics of taxpayers. It is our position that only a couple of allowances should be offered, because it keeps taxation simpler. One form of personal allowance already exists in current PIT, but only in taxation of monthly salaries in the form of withholding tax (it is called non-taxable threshold). In calculation of taxable income, many deductions must exist, because taxpayers have costs to obtain income. One of the function of deductions is to favour certain economic choices so authorities have to consider which choices to support (for example, if the expense of interests can be deducted from taxable income then individuals have a tax relief if they take a loan for buying a house). Not to many deductions should be offered in Serbia, because it complicates taxation and affects tax efficiency.

In the matter of tax brackets, first question is how many tax brackets to set. Our opinion is not to many. As it can be seen from Table 2, in the last decade (period from 2001 to 2010) number of tax brackets decreased significantly in almost all selected OECD countries. In 2001, many countries had six or even seven tax brackets, while in 2010 none of the countries had seven tax brackets and only United States had six tax brackets. Also, many countries, like Czech Republic or Slovakia introduced flat tax. Other clear trends that emerged from 2000 to 2010 include a reduction in the income threshold where the top statutory PIT rate applies (minimizing the impact of the top statutory rate cuts), and a reduction in the statutory rate applicable at average wage earnings (Torres et al., 2012). Also, in creation of a tax rate schedule, it must be decided whether personal allowance would be used or a zero tax rate. An initial level of income can be exempted from tax at any stage in the calculation of taxes payable – when the tax base is determined (through an allowance), when tax on taxable income is calculated (through a zero statutory rate), or when net tax is calculated (through tax credits) (Torres et al., 2012). The tax allowance and zero-rate bracket result in identical average tax rates if the taxable income thresholds for all the tax brackets over the zero-rate bracket are shifted by the amount of basic allowance relative to the bracket thresholds under the basic allowance. Although it is merely a matter of technicality, some economists think that zero tax rates are more favorable because they are more transparent.

Some proposals suggest that in Serbia only two marginal tax rates should exist. Of many propositions we have selected two. The first proposition is: 15% tax rate for taxable income from zero to 200% of average annual gross salary, and 25% above that threshold. The second scenario is: 15% tax rate for taxable income from zero to 150% of average annual gross salary, and 30% above that threshold (Altiparmakov and Vesnic, 2007). These tax rate schedules should be combined with personal allowances so both indirect and direct progression would function. Size of personal allowance is a matter of discussion, but in two selected scenarios they should account for 25% of average annual gross salary in 15%-25% tax rate schedule and 40% of average annual gross salary in 15%-30% schedule. These personal allowances are much higher than current non-taxable threshold. Presented tax rate schedules are revenue neutral. If it is the intention of Serbian government to shift

## INTRODUCTION OF COMPREHENSIVE PERSONAL INCOME TAXATION AS A POSSIBLE WAY TO IMPROVE TAX SYSTEM IN SERBIA

the burden of negative economic trends more to high-income taxpayers then these solutions seem to be optimal, because of the rapid rise of marginal rate in the second bracket. Number of taxpayers in the upper tax bracket would not be significant, but still, this is much better solution than current annual income where applied threshold is three average annual gross salaries (this is the reason why less than 1% of taxpayers pay this tax).

**Table 2: Marginal tax rates in selected OECD countries (period 2001-2010)**

<b>2001 Country</b>	<b>Marginal Rate<sub>1</sub>(MR)<sub>1</sub></b>	<b>MR<sub>2</sub></b>	<b>MR<sub>3</sub></b>	<b>MR<sub>4</sub></b>	<b>MR<sub>5</sub></b>	<b>MR<sub>6</sub></b>	<b>MR<sub>7</sub></b>
Austria	0.00	21.00	31.00	41.00	50.00		
Belgium	25.00	30.00	40.00	45.00	50.00	52.50	55.00
Canada	16.00	22.00	26.00	29.00			
Czech Rep.	15.00	20.00	25.00	32.00			
Denmark	6.25	12.25	27.25				
Finland	0.00	14.00	18.00	24.00	30.00	37.00	
France	0.00	7.50	21.00	31.00	41.00	46.75	52.75
Germany	0.00	19.90	48.50				
Italy	18.00	24.00	32.00	39.00	45.00		
Japan	10.00	20.00	30.00	37.00			
Netherlands	2.95	8.20	42.00	52.00			
Slovak Rep.	12.00	20.00	25.00	30.00	35.00	40.00	42.00
Spain	15.00	20.17	23.57	31.48	38.07	39.60	
Sweden	0.00	20.00	25.00				
UK	10.00	22.00	40.00				
US	10.00	15.00	27.50	30.50	35.50	39.10	
<b>2010 Country</b>	<b>Marginal Rate<sub>1</sub>(MR)<sub>1</sub></b>	<b>MR<sub>2</sub></b>	<b>MR<sub>3</sub></b>	<b>MR<sub>4</sub></b>	<b>MR<sub>5</sub></b>	<b>MR<sub>6</sub></b>	<b>MR<sub>7</sub></b>
Austria	0.00	36.50	43.21	50.00			
Belgium	25.00	30.00	40.00	45.00	50.00		
Canada	15.00	22.00	26.00	29.00			
Czech Rep.	15.00						
Denmark	3.67	18.67					
Finland	0.00	6.50	17.50	21.50	30.00		
France	0.00	5.50	14.00	30.00	40.00		
Germany	0.00	14.00	45.00				
Italy	23.00	27.00	38.00	41.00	43.00		
Japan	5.00	10.00	23.00	33.00	40.00		
Netherlands	2.30	10.80	42.00	52.00			
Slovak Rep.	19.00						
Spain	15.66	18.27	24.14	27.13			
Sweden	0.00	20.00	25.00				
UK	20.00	40.00	50.00				
US	10.00	15.00	25.00	28.00	33.00	35.00	

Source: OECD Tax Database, <http://www.oecd.org/tax/taxpolicyanalysis/oecdtaxdatabase.htm#pir> (date of visit to site 10/07/2012)



Chart 1 illustrates distribution of income in Serbia by deciles of population. As it can be seen, lowest decile has average income of only 22% of average income in Serbia, while second accounts for 47%. This means that, with generous personal allowances previously described, first decile of population will not even pay tax, while the tax bill of second decile will be minor. Also, proposed tax rates are still lower than in most OECD countries, while top marginal rate is well below average OECD top statutory marginal tax rate (which in 2010 was around 41.5%) (Brys et al., 2011).

**Chart 1: Average income of deciles of population in Serbia (expressed in percents of average income in Serbia)**

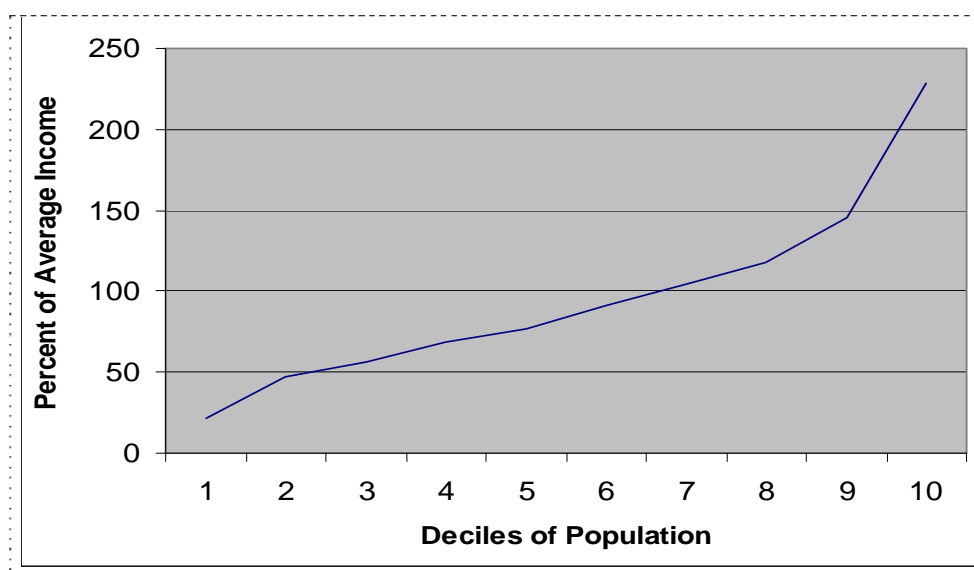

Source: Based on data from Living Standard Measurement Study – Serbia 2002-2007, Statistical Office of the Republic of Serbia, p. 34

Tax credit can represent an important part of PIT system. In Serbia, tax credit currently plays a little role in personal income taxation, while it is well established in corporate income taxation. It could be used to promote social goals, such as disability credit, child tax credit or to promote labour supply, such as earned income tax credit. These are all options for Serbian PIT. Tax credits affects directly tax bill, they are transparent and easy to comprehend, so it might be realistic element to be introduced.

**Possible Advantages and Limitations of Proposed Solutions and Alternative Propositions**

Main advantage of introduction of progressive income taxation in Serbia is improvement of vertical equity because redistribution of income should work. However, a larger rise in marginal tax rates is probably needed to achieve increased level of vertical equity. High marginal rates could be counterproductive for many reasons. If Serbian economy tends to grow and develop on knowledge-based industries it needs especially high qualified labour force. It is very clear that such labour force earns high salaries and its income is therefore taxed by high marginal tax rates in the higher tax brackets. If the tax burden on high income is big, high qualified workers will leave the country and work elsewhere. Serbian economy would hereby lose a crucial factor for the future development, with long-run consequences, and would in the short run lose tax revenue. Also, higher marginal tax

## **INTRODUCTION OF COMPREHENSIVE PERSONAL INCOME TAXATION AS A POSSIBLE WAY TO IMPROVE TAX SYSTEM IN SERBIA**

---

rates, which must be used to place the tax burden more on high-income families, causes more welfare loss due to disincentives to work, save, and invest (Jagric et al., 2009).

Some recent studies show that personal income tax has done little, if anything, to reduce inequality in many developing countries. Second, it is not costless to pretend to have a progressive personal income tax system. Tax systems generate real administrative, compliance, economic efficiency and political costs (Bird and Zolt, 2005). Surprisingly, most studies in developed countries have found that nominally progressive tax systems have weak redistributive effects. Finally, governments that are concerned with poverty reduction or wish to ensure that public services are provided relatively equitably to all citizens, given the relatively much greater gain to low-income people from equal services, seem better advised to attempt to achieve such goals through expenditure programs rather than tax policy. Another argument is that tax systems simply cannot be too progressive in many developing countries. The costs are too high and the gains too low. Instead, given the limited instruments available to such countries and the widespread market failures characterizing them, perhaps the best policy is to introduce a broad-based VAT to finance necessary government expenditure (Bird and Zolt, 2005).

If Serbian tax authorities carry out personal income tax reform along with increasing VAT rate, (a solution that is most considered by Ministry of Finance) it is most likely that vertical equity will be compromised. However, there can also be some benefits from performed actions. In Serbia, employers often pay their workers out in cash to avoid paying tax, while all VAT liabilities remain regularly accrued and settled. On the other hand, it is not recorded that employer regularly reports gross wages of his employees and hide some part of VAT revenue (Altiparmakov, 2010). Considering the above mentioned, we estimate that personal income tax evasion is much greater than VAT evasion. If we tax more formal sector (registered income) and less informal sector (unregistered income), by definition it should decrease the size of informal sector in Serbia. Also, exports are not subjected to VAT, but the tax burden on labour is included in export prices, so if we rely more on indirect taxation, it could improve position of Serbia in international trade flows. If the VAT rate increase is offset by a reduction in the direct taxation of labour, then the overall effect on competitiveness could be positive: this is because domestic producers will reap the full benefit of the cut in direct taxes, but the increase in VAT will be “shared” with foreign competitors, because exports are zero-rated for VAT purposes and imports are taxed at the same rate as domestically produced goods (Brys, 2011).

K.P. Sabirianova et al. (2009) on a sample of 189 countries throughout the world show that taxpayers on average face lower personal income tax rates and simpler rate structures than they did twenty five years ago. Along these lines, Alm and Wallace (2004) have suggested that the individual income tax should be imposed at constant marginal tax rates on broadly defined, and schedularly defined, tax bases with minimal use of special tax incentives and with similar tax rates imposed on the different schedular bases. Such a tax (coupled with a corporate income tax at the same rate), together with a broad-based VAT, appropriate excise taxes, more use of local and benefit financing, and, above all, improved expenditure policy, seems likely to provide much firmer footing for redistributive policies in developing countries than the highly progressive personal income tax imposed on a comprehensive base.

Some researches conducted in Serbia show that comprehensive personal income taxation is not the optimal solution in the case of Serbia. Altiparmakov and Vesnic (2007) conclude that introduction of comprehensive income taxation would create increased compliance costs for the taxpayers, because the number of taxpayers who file a tax return would significantly rise. Also, they analysed four alternative revenue neutral scenarios of progressive income taxation by changing the level of untaxable threshold and tax rates. The tax rates in two cases are flat so indirect progression is in place, while they are progressive in other two cases (two tax brackets and two marginal tax rates). Revenue neutral tax rates in all four scenarios are higher than the current tax rate on labour income (salary), so they open space for increased tax evasion. Arsic M. et al. (2009) state that flat tax option or a simpler

version of comprehensive income taxation is most appropriate in Serbian case, and they conclude that simple scenario with one or two marginal rates at most and minimal number of deductions is required.

## Conclusions

Personal income tax in Serbia requires significant modifications. Fact is that Serbian PIT does not create revenue as large as in most OECD countries, and VAT revenue and social security contributions are much more significant. Considering that, it is very hard to fight income inequality using PIT. To achieve higher vertical equity, it is important to implement comprehensive taxation, so the redistribution of income could work. But this type of reform requires more tax authorities proficiency and could create higher compliance and administrative costs. It is hard to estimate whether benefits of higher income equality are great enough to overcome increased costs. Implementation of a simpler type of comprehensive taxation seems to be the most suitable solution for Serbia, with only two or three at most marginal tax rates, while personal allowance to be offered should be generous. In that way, some level of income redistribution would be achieved, while administrative costs would not increase sharply.

In the long run, it is hard to expect that PIT could generate higher revenue, because tax burden on labour income is already substantial, not because of PIT itself, but because of the impact of social security contributions. Negative demographic trends suggest that the real problem in the future will not be the impact of PIT on tax burden, but social security contributions' impact. Moreover, every proposed PIT reform of Serbian authorities has been revenue neutral, while other solutions are considered to increase public revenues (VAT rate increase, for example). The future of PIT in Serbia is not easy to anticipate.

## References

- Alm, J., Wallace, S., (2004), Can Developing Countries Impose an Individual Income Tax?, *The Challenges of Tax Reform in a Global Economy*, Andrew Young School of Policy Studies, International Studies Program, Georgia State University, Stone Mountain Park, pp. 1-58
- Altiparmakov, N., (2010), Poreski sistem u funkciji zapošljavanja i ekonomskog rasta: nacrt za Srbiju, *Poreska politika u Srbiji – pogled unapred*, USAID Sega Project, Belgrade, pp. 22-38
- Altiparmakov, N., Vesnic, B., (2007), Reforma poreza na dohodak građana-misli globalno, deluj lokalno, *Quarterly Monitor*, No. 10, Foundation for the Advancement of Economics pp. 84-91
- Arsić, M., Randelović, S., Altiparmakov, N., (2009), Mogući pravci reforme poreza na dohodak građana u Srbiji, *Quarterly Monitor* No. 17, Foundation for the Advancement of Economics, pp. 96-108
- Bird, R., Zolt, E., (2005), The Limited Role of Personal Income Tax in Developing Countries, *Journal of Asian Economics*, No. 16, pp. 928–946
- Brys, B., (2011), Making Fundamental Tax Reform Happen, OECD Taxation Working Papers, No. 3, OECD Publishing, available at <http://dx.doi.org/10.1787/5kg3h0v54g34-en>
- Brys, B., Heady, C., (2006), Fundamental Reform of Personal Income Tax in OECD Countries: Trends and Recent Experiences, available at [https://editorialexpress.com/cgi-bin/conference/download.cgi?db\\_name=IIPF62&paper\\_id=121](https://editorialexpress.com/cgi-bin/conference/download.cgi?db_name=IIPF62&paper_id=121) ( 3.3.2012)
- Brys, B., Matthews, S., Owens, J., (2011), Tax Reform Trends in OECD Countries, OECD Taxation Working Papers, No. 1, OECD Publishing
- Cok, M. et al., (2011), Distribution of Personal Income Tax Changes in Slovenia, MPRA Paper No. 32704, available at <http://mpra.ub.uni-muenchen.de/32704/>

## **INTRODUCTION OF COMPREHENSIVE PERSONAL INCOME TAXATION AS A POSSIBLE WAY TO IMPROVE TAX SYSTEM IN SERBIA**

---

- Jagic, V. et al., (2009), Personal Income Tax Reforms as a Competitive Advantage, Economy Series, Issue 1/2009, *Annals of the „Constantin Brâncuși” University of Târgu Jiu*, pp. 189-218
- Living Standard Measurement Study – Serbia 2002-2007, (2008), Statistical Office of the Republic of Serbia, Belgrade
- Randelović, S., (2008), Dual Income Tax - An Option for the Reform of Personal Income Tax in Serbia, *Economic Annals*, Vol. 53, Issue 178-179, pp. 183-197
- Sabirianova, K.P., Buttrick, S., Duncan, D., (2009), Global Reform of Personal Income Taxation-Evidence from 189 Countries, Working Paper 08-8, Research Paper Series Andrew Young School of Policy Studies
- Torres, C., Mellbye, K., Brys, B., (2012), Trends in Personal Income Tax and Employee Social Security Contribution Schedules, *OECD Taxation Working Papers, No. 12*, OECD Publishing, available at <http://dx.doi.org/10.1787/5k95qw9633vf-en>
- Wołowiec, T., Soboń, J., (2011), EU Integration and Harmonization of Personal Income Taxation, *Contemporary Economics*, Vol. 5 Issue 1, pp. 36-46

### **Online sources:**

<http://www.oecd.org/tax/taxpolicyanalysis/oecdtaxdatabase.htm#pir>

# BANKING FOR POOR AS A STRATEGY FOR LOCAL SUSTAINABLE TOURISM DEVELOPMENT

Zoran Temelkov<sup>1</sup>

Marina Bojčeva<sup>2</sup>

Darko Dimitrovski<sup>3</sup>

**Abstract:** *Transitional economies are faced with economically underdeveloped regions that have the capacity for sustainable tourism development, but potential entrepreneurs lack the necessary funds. Banking for poor and pro poor strategies have mutual objective i.e. poverty decrease. Modifying the banking for poor products in accordance to the need of local tourism entrepreneurs would offer the possibility for local development. This development would contribute toward the creation of new employment of local residents. More over, it would have a direct economic impact on the local village economy and wider area. Banking for poor proved itself as a strategy that is successfully reducing poverty. Focusing on the pro poor banking for tourism activities, it may become efficient strategy for local sustainable development of specific regions. After presenting the impact of banking for poor on entrepreneurship development in poverty regions, the purpose is to analyze whether modification of banking for poor products could support the pro poor tourism entrepreneurship.*

**Keywords:** *banking for poor, pro poor, tourism, economic development, Macedonia*

## Introduction

The aim of this paper is to evaluate the possibility of banking for poor model as a strategy for local sustainable development of underdeveloped regions, combined with the pro poor tourism expansion. Although the banking for poor model has high success rate in economic development for high poverty regions, some modifications are needed. These modifications should be made in order for the model to be applicable in transitional economies. Informal interviews have been conducted for the purpose of this research. The findings indicate that there is a possibility for tourism development as long as the financing barriers are removed. This removal should be directed toward financing of a fully developed value chain business plans in which different entrepreneurs would be involved, which is supporting the achievement of mutual goal. Underdeveloped regions in Macedonia are defined according to the socio-economic index and the demographic index. Some of the indicators employed are GDP per capita, budget income per capita, ageing coefficient, and natural population increase.

## The potential of underdeveloped regions

Underdeveloped regions could be defined as regions having low standard of living as well as undeveloped industrial base. These regions are faced with low income, high unemployment, poverty and low levels of capital availability. From economic point of view, such regions are to be avoided for

---

<sup>1</sup> Faculty of Tourism and Business Logistics, Goce Delcev University, Štip, zoran.temelkov@ugd.edu.mk

<sup>2</sup> Faculty of Economics, Goce Delcev University, Štip

<sup>3</sup> School of Economics, Kragujevac

## **BANKING FOR POOR AS A STRATEGY FOR LOCAL SUSTAINABLE TOURISM DEVELOPMENT**

possible investment activities; on the other hand, from a point of sustainable development, these regions should be of particular interest. Sustainable development recognizes not only the importance of augmentation of economic resources but also the enrichment of environmental and social resources. The purpose of sustainable development is to fulfil the needs of existing generations, without hindering the resources for future generations. Sustainability as defined by Gilbert et al. (1996) and Dillard, J., Dujon, V. and M. King (2009) has three components:

- “Environmental sustainability-which requires that natural capital, remains intact. This means that the source and sink functions of the environment should not be degraded. Therefore, the extraction of renewable resources should not exceed the rate at which they are renewed, and the absorptive capacity to the environment to assimilate wastes should not be exceeded. Furthermore, the extraction of non-renewable resources should be minimized and should not exceed agreed minimum strategic levels.
- Social sustainability-which requires that the cohesion of society and its ability to work towards common goals be maintained. Individual needs, such as those for health and well-being, nutrition, shelter, education and cultural expression should be met.
- Economic sustainability-which occurs when development, which moves towards social and environmental sustainability, is financially feasible.”

The potential for sustainable development of underdeveloped regions is substantial. Unlike the developed regions, underdeveloped regions could easily achieve sustainable development because they have particularly nothing, so it is an advantage. The advantage is consisted in the fact that nothing should be changed in the regions all it takes is to set a proper strategy regarding the direction of development of the region. The strategy should take into consideration the three components of sustainable development i.e. environmental, social and economic development. Sustainable tourism development is a strategy that is becoming popular for sustainable development of these regions.

For the purpose of developing a tourism development strategy or development strategy in general for that matter, everyone should constantly pay attention to the poverty cycle and should constantly answer the question “is the strategy capturing all aspects of the poverty cycle”.

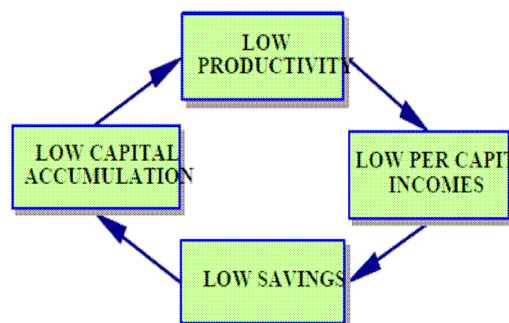

**Figure 1. Vicious Cycle of Poverty as defined by Guy Vincent (n.d)**

*Source: Guy Vincent (n.d)*

This cycle is undoubtedly presenting the obstacle eroding the potential of underdeveloped regions. Meaning that whatever part of the cycle is observed one can conclude that a limited financial resource is crucial factor limiting the actions against poverty.

## Literature review

The banking for poor is a concept existing for the last couple of decades. The notion behind this concept is to open the access to necessary funds to financial impeded and economically excluded regions. People with residency in poverty regions should be entitled to the financial services such as loans, deposit and insurance. This access to financial products is expected to improve the income, increase the asset and thus improve the living standard of the poor population (Khavul, 2010; Hinson, 2010). The need for banking the poor emerged as a result of the functioning of the conventional banking. Namely, conventional banking loans require collateral and high level of information in order to avoid asymmetric information risk (Schoombee, 2000). The people in poverty regions, who are at the same time potential entrepreneurs, lack the needed collateral and the conventional banking model is difficult to implement due to deficiency of required information (Dusuki, 2008). Moreover, the loans issued by the conventional banking are in larger amounts usually too large for a poor entrepreneur either to take the loan or make full use of the loan. For this reason banking the poor through micro loans are satisfying the need of the poor population.

Microcredit or micro loan is a small in amount, unsecured loan issued for starting up a new business or growth of an existing one (Khavul, 2010). Main objective of microfinance is to encourage entrepreneurial activity for the purpose of achieving local and regional economic growth (Khavul, 2010, Sarker, 2001). Unlike the western entrepreneurs, these entrepreneurs are considered to be the micro entrepreneurs due to the small scale of their operation. In addition, the aim of these micro entrepreneurs is not to get rich, instead their aim is to use micro loans in order to earn profit that will take them out of the poverty situation and provide for their basic needs (Robinson, 2001).

There are many programmes operating under the model of banking for poor and micro financing, such as the Grameen Bank in Bangladesh, Self-employed women's association in India, The savings movement in Zimbabwe, and many other. Grameen Bank was initiated in 1976 with the objective to make loans available to poor population having no collateral (Egger, 1986). Grameen Bank is requiring no collateral and is issuing the loans based on group liability, where if the loan is not repaid no-one else from the liability group will be granted a loan. The repayment is made on weekly bases where the loan matures in one year. Moreover, Grameen Bank is promoting the savings in a form of mandatory saving amount i.e. the borrower is obliged to deposit certain amount for a pre specified period. Different programmes are tailored in accordance to the local need of the population for additional capital, for the purpose of supporting their entrepreneurial activities. The common for all programmes is that they give small amount of loans to the poorest population in the high poverty regions. The former is one of the issues that are considered as a barrier for banking the poor model in transitional economies.

The benefit arising from banking for poor model is consisted in its financial products or more precisely the loans availability and saving products. Characteristics of the banking for poor micro loans are as follows:<sup>4</sup>

- Relatively low amount of loan
- Repayment is made on a weekly or biweekly basis
- Loan maturity is up to 18 months
- Interest are lower than the one required by the conventional banks
- No collateral required, loan is secured by group liability

---

<sup>4</sup> Benchmarking of the microfinance in Mexico: A report on the sector, report provided by ProDesarrollo finanzas y microempresa, A.C. 2008.

## **BANKING FOR POOR AS A STRATEGY FOR LOCAL SUSTAINABLE TOURISM DEVELOPMENT**

- Only when the loan is repaid, new loan can be issued
- Low level of documentation

Moreover, the banking for poor is also encouraging the saving through its saving products, where clients agree to save small portions on a regular basis (Robinson, 2001). The purpose of the saving products is to provide some financial stability for the poor entrepreneurs as well as help them save for the purchase of larger items (investment, housing, schooling, etc).

Financial products designed in this manner are beneficial for the entrepreneurs. That is, one of the biggest obstacles when going through the conventional banking is the required collateral, which in many cases is not sufficient or even non-existing. Next, are the high interest rates charged by the bank, because the high interest rates are eating up the profit of the entrepreneurs, and it might turn out that their business is operating simply to cover the interest expenses. High level of documentation required by conventional banks is eliminated under the concept of banking for poor. Primary reason is the high illiteracy of the poor population, as well as the high costs associated with lot of paperwork.

Banking for poor model was initially design for high poverty regions, where small amount of loans could make big difference in entrepreneurial activities. The flourishing existences of micro financing institution as well as the numerous success stories are proof by itself about the accomplishment of this model. In the following table examples of financial institutions which are operating under the model of banking for poor and micro financing.

**Table 1: Micro financing institutions**

<b>Institution</b>	<b>Country</b>	<b>Total Loans issued</b>	<b>No. of borrowers</b>
Grameen Bank <sup>5</sup>	Bangladesh	\$ 11.35 billion	8.350.000
Kiva <sup>6</sup>	International	\$340,878,100	839,043

Source: According to data obtained at  
[http://www.grameeninfo.org/index.php?option=com\\_content&task=view&id=26&Itemid=175](http://www.grameeninfo.org/index.php?option=com_content&task=view&id=26&Itemid=175) and  
<http://www.kiva.org/about/stats>

It can be seen that the two institutions listed, have provided support to more than 9 million entrepreneurs in the poverty regions, and helped improve their quality of life.

In his research regarding the relationship between microfinance and entrepreneurship development in Nigeria, Olu (2009) finds a positive relation. Namely, he is concluding that microfinance institutions can be an important apparatus in the support of entrepreneurial activities.

In a researched based on case studies and sample survey of businesses it has been found that establishing a proper access to financial resources is enhancing the entrepreneurship performance in Tanzania (Kuziliwa, 2005). Proper access to financial resources is taking into consideration the terms under which the loan is issued<sup>7</sup>.

<sup>5</sup> Data obtained at  
[http://www.grameeninfo.org/index.php?option=com\\_content&task=view&id=26&Itemid=175](http://www.grameeninfo.org/index.php?option=com_content&task=view&id=26&Itemid=175)

<sup>6</sup> Data obtained at <http://www.kiva.org/about/stats>

<sup>7</sup> Terms such as: interest rate, collateral requirement, repayment period, loan amount, etc.



Results from a state level analysis in India for the period 1961-2000, reveal that the bringing branches in rural areas has opened access to financial resources of local population and thus considerably decreased the poverty level in rural areas (Burgess, Pande and Wong, 2005).

**Benefits of local tourism development**

The benefits of local tourism development are as a result of the capacity of tourism for wealth distribution across different areas in a sense that this wealth would not flow into the local economy using other resources. The tourism development by itself can have positive economic impact in many different ways. First and foremost it is a mean of direct and indirect job creation, where local residents have the opportunity to start entrepreneurial activities (i.e. family run business). Manufacturing facilitates are inferior in comparison to the tourism development as a means for combating poverty and unemployment. This is in a sense that tourism industry is more labor intensive and offers more opportunities for the creation of local family businesses from value chain point of view (Akyeampong, 2011). On individual level tourism related entrepreneurial activates provide a possibility for improvement in their living standards. On local level these activities are strengthening the local economy, since money is being spent in the local businesses. Akyeampong (2011) is arguing that the perception<sup>8</sup> regarding the tourism development is crafting a strategy which, at the same time, will develop suitable tourism products and augment the living standards of the local population.

Careful strategic planning about the need for specific businesses in the area could eliminate the potential competition between the local entrepreneurs and thus secure them a sure profit and strengthening of the local economy. That is creation of businesses in accordance to the needs of the value chain related to tourism activities. Another benefit of tourism development is the diversification of local economy i.e. economic prosperity having multiple industries is reducing the exposure of the economy to potential shocks and crises. This diversification could secure stability in the living standards of local residents. Example of the areas and way in which pro poor tourism can impact the underdeveloped regions depending of the strategic priorities are presented in Table 2.

**Table 2: Pro poor tourism strategies**

<b>Increase economic benefits</b>	<b>Enhance non-financial livelihood impacts</b>	<b>Enhance participation and partnership</b>
Boost local employment, wages	Capacity-building, training	Create more supportive policy/planning framework
Boost local enterprise Opportunities	Mitigate environmental impacts	Increase participation of the poor in decision-making
Create collective income sources, e.g. fees, revenue, shares	Address competing use of natural resources	Build pro-poor partnerships with private sector
	Improve social, cultural impacts	Increase flows of information, communication
	Increase local access to infrastructure and services	

Source: Akyeampong (2011) adapted from - Ashley et al. (2000)

<sup>8</sup> The opinion of respondents around the Kakum National Park in Ghana’s Central Region

## **BANKING FOR POOR AS A STRATEGY FOR LOCAL SUSTAINABLE TOURISM DEVELOPMENT**

This section should be concluded the fact that the world wide importance of the tourism industry is evident from the actuality that almost one tenth of world's labor force is employed in this industry and tourism is producing around 10% of the world income (Mirbabayev and Shagazatova, 2006).

For a simple illustration of the impact that banking for poor and microfinancing institutions have on the poor entrepreneurs, a real life case is presented in Box 1 (Felder-Kuzu, 2006).

### **BOX 1. Real life impact of micro finance institution**

Margoth builds her dream house by making and selling chocolates Margoth Ramirez has been selling homemade chocolates for the past 12 years. She sells her chocolates at the Dueñas Market, a popular food market in Nuevo San Salvador, located on the outskirts of the capital of El Salvador.

Margoth is 43 years old. She has a son, Javier, and two daughters. She is a client of Apoyo Integral, a Micro Financing Institution with a nationwide network in El Salvador. Margoth will be moving into her dream house in a few months. It is a dream come true and something that she could not have imagined 12 years ago when her husband lost his job and left her with the children. Margoth recalls her situation 12 years ago as the most difficult time in her life.

After a week I was left with 20 dollars. I went to the food market and wandered around desperately thinking what I could buy to make some money out of it. I saw a pile of cacao beans in one of the food stand. I counted my money and used a part of it to buy 2 pounds of cacao beans, cinnamon, and some sugar. I went back home to make a chocolate. I returned the next day to the market sold the few chocolates I had made. I also made a little profit so I bought again the same amount of cacao beans, sugar, and some food and hurried home.

Margoth continued this routine for the next few weeks. One day, a lady who had bought her chocolate approached her and said she would like to put a large order for the next day. This lady, had a big stand in the market and wanted to buy 25 dollars worth of chocolate. Margoth realized that she did not have the money to buy the ingredients necessary for such a large order. Margoth explained her situation with embarrassment. Carmen smiled and gave her the whole amount in advance.

Half a year later, Margoth heard that one could get loans by joining a solidarity group. She joined such a group and soon she got a loan of US \$ 100 for working capital. She was able to buy cacao and sugar in bulk and ordered a big pan to roast the cacao beans. She made more money, so she started to save, every day she saved even if it was a small amount.

She was determined to work hard and one day to be able to live in a nicer place with a proper kitchen. In 2002, Margoth became a client of Apoyo Integral through a solidarity group.

Her first loan was US \$ 200 with a duration of 10 weeks. For the past three years, she has been taking loans for working capital with durations of 10 –17 weeks.

The last couple of loans have been between US \$ 600 –750. In 2003, she qualified for the housing loan (one year term) of US \$ 1,145 and, after having repaid it, she qualified for a 3 year housing loan of US \$ 1,500.

### **Pro poor banking for tourism activities as a development strategy**

The common for all programmes operating under the banking for poor model is that they give small amount and short term loans to the poorest population in high poverty regions. The former is one of the issues that can be considered as a barrier for launching banking the poor model in transitional economies. Moreover, all of the programmes are primarily focused on specific area such as loans for agricultural entrepreneurs, loans for rickshaw pullers, loans for women entrepreneurs, etc. Unlike the high poverty regions, underdeveloped regions in transitional economies have till some extent capital accumulation, higher costs, and certain level of business activity. Thus micro loans of couple of tens to couple of hundred dollars are insufficient for development of entrepreneurial activity.

Pro poor banking for tourism activities is realizable after resolving the possible barriers. In other words, in order for it to be applicable as a development strategy the loan amount should be increased and repayment period extended (Meyer, 2001), keep the group liability, and low loan cost such as low interest rate along with low transaction and approval expenses paid by the entrepreneur.

Pro poor banking for tourism could support the tourism development and the general development of the local economy, through value chain loans and value chain liability (group liability). Since tourism as a strategy for development is more than just the opening up of available accommodation spaces (hotels, motels, villas, etc), entrepreneurs from the entire value chain should participate in local development and development of local tourism capacities. With other words, tourism is creating direct and indirect employment, such as running a hotel or bar (direct jobs) and laundry business or souvenir stores (indirect jobs). This is the notion behind pro poor banking for tourism through value chain loans. Specifically the common denominators for direct and indirect jobs are the tourists. Implying that the local entrepreneurs will not compete against each other instead they will work together because if there are no tourists everybody is losing money. Thus cohesion in the village (area) will be achieved since each one is directing its efforts to achieve a common goal.

Although everything might look nice, limited access to funds is still a major obstacle which is hindering local development of poverty regions in transitional countries.

### **Methodology**

For the purpose of this research a methodology chosen for collection of qualitative data is an interview. More precisely, an informal conversation interviews have been conducted. These types of interviews have been used because there was the need not to direct the interviewee's, instead the goal was to see their expectations, opinions and personal feelings regarding the issues under consideration. Moreover, structuring the methodology employing interviews enabled us to obtain highly personalized data. Due to the very poor knowledge about the banking for poor concept in Macedonia as well as non-existence of these types of financial products<sup>9</sup>, interviews have been most adequate. This is so in a way that structured interviews will direct the interviewee's on a subject they are not familiar with, and the data will have almost no validity. As far as the quantitative analyses are concerned, there is lack of adequate data for Macedonia.

The underdeveloped regions in Republic of Macedonia are defined according to the socio-economic index and the demographic index.<sup>10</sup> Indicators used for the socio-economic index are: GDP

---

<sup>9</sup> It should be noted that there is a micro financing institution operating in Macedonia, but the terms for financing are not in line with the core values of the concept banking for poor and micro financing subject of this research.

<sup>10</sup> Verica Janeska and Štefan Bojnec (2011) "Rural Labor Market Developments in the Former Yugoslav Republic of Macedonia", Working Paper No. 5, September, Centre for European Policy Studies.

## **BANKING FOR POOR AS A STRATEGY FOR LOCAL SUSTAINABLE TOURISM DEVELOPMENT**

per capita, budget income per capita and increase in the added value of the nonfinancial sector. Indicators for the demographic index are: natural population increase, ageing coefficient, net migration per 1000 inhabitants and graduated students per 1000 inhabitants.

The interviews were carried out in Stip and Probistip, towns located in East Macedonia. Stip is chosen due to the developments in the last couple of years, which significantly increased the day travellers to and from Stip<sup>11</sup>. Probistip has been chosen as a location for this research because of the existence of mining industry as well as the opening of an Aqua Park. In both towns an opportunity was created for local entrepreneurs to expand existing business or start a family business. According to the East region Development Plan, this region is classified as underdeveloped region.

East region has the following characteristics:

- Unemployment rate of 16,4%, out of which 12.7% are located in the rural areas
- Average net wage per employee of 15.131, 00 MKD<sup>12</sup> ( 244 euro<sup>13</sup>)
- Mountainous terrains adequate for development of winter and alternative tourism.
- The region has developed lead and zinc mining industry (impeding the environmental resources)
- GDP per capita of 206.770,00 MKD (3335 euro)<sup>14</sup>

The sample included in this research was consisted of 49<sup>15</sup> respondents belonging to one of the following four categories: Owners of business in the tourism industry, people employed in the tourism industry, people employed in other sectors and representatives of the unemployed population. In table 3 are listed the categories and the sample of respondents. Taking into consideration the age structure of the respondents, 61% are between 25 – 35 years old, whereas the remaining are above 35 years old.

**Table 3 : Number of respondents by category**

<b>Category of respondents</b>	<b>No. of respondents</b>
Owners of business in the tourism industry	9
People employed in the tourism industry	11
People employed in other sectors	13
Representatives of the unemployed population	16
<b>Total</b>	<b>49</b>

*Source: Author's research.*

The interviews have been conducted during a three month period, April, May and June in the current year. All respondents are residents of towns located of the Eastern Macedonia, labelled as

<sup>11</sup> In 2007 the University of "Goce Delcev" has been opened with its primary location in Stip.

<sup>12</sup> National average is approximately 21.000,00 MKD (around 300 euro)

<sup>13</sup> 62 MKD = 1 euro

<sup>14</sup> Source: "Regions of the Republic of Macedonia 2012", Regional yearbook, State Statistical Office of the Republic of Macedonia

<sup>15</sup> The initial planned sample was 100 respondents, but as a result of the limited resources as well as the reluctance of people to accept the interview process the final sample was brought down to 49 respondents.

underdeveloped and/or border regions. Main goal of the interview was to gather data regarding the expectations and the perception of residents from underdeveloped regions about the tourism development, its sustainability and access to funds for enhancement of entrepreneur's activities.

### **Results and findings**

The interviews conducted were informal and the interviewee should have stated their expectations and perception about the tourism development and its sustainability along with the access to capital. The various categories of respondents gave their unique view for their expectations and presented some interesting ideas regarding the tourism development. Although anticipated, the level of financial illiteracy in all four categories was surprisingly high, 81% of participants' stated that they have highly limited access to financial resources. In addition, business owners stated that they can access the loans due to certain level of collateral in their possession, but their perception is that the capital is very expensive due to the high interest rates they pay.

The findings indicate that, one way or another, all participants are supporting the idea that tourism development is an industry that can decrease unemployment and boost the economic development of their region.

Business owners provided significant opinion regarding their expectations of the direction of development of service activities. Meaning that they would rather outsource some of their operations in order to reduce their costs and focus on their core activities. This is in a sense that they would rather pay for services such as laundering, and marketing. In addition, existing entrepreneurs and the potential entrepreneurs argued that due to transportation cost and low bargain power they cannot strike down the price of their supplies. The unemployed and employed respondent's main problem, if they start a family business, would be inappropriate terms offered by supplies due to the skepticism about the success of start up business.

Coming to the banking for poor model none of the respondents were familiar with this model and the notion behind it. After brief explanation for the purpose and the success rate of banking for poor concept the respondents accepted it a strategy that will certainly help them in their entrepreneurial activities. This concept was especially welcomed by the unemployed respondents who, in some form, stated that these financial products would get them out of poverty. The most important feature was the group liability option instead of collateral requirement.

Another point made by the respondents that is worth mentioning is that the full picture of a region to be perceived as a tourist destination is missing. Stated differently, although an accommodation facilitates might exist, there is a lack of other tourist related facilitates. These facilitates might be souvenir shop, recreational facilitates, facilities giving the possibility to experience the local heritage, etc. Some of the respondents (18 to be precise) showed certain level of skepticism that cheap capital would be enough for the tourism development. The skepticism was a result of the low interest expressed by the authorities in supporting the entrepreneurial growth, regardless of the municipality's official strategy for tourism development.

### **Concluding remarks**

Banking for poor has proven itself as a successful model in the fight against poverty. It's track record shows that the financial products developed under this model gave support to millions of entrepreneurs and increase the living standards of specific regions thanks to the economic development arising from these entrepreneurial activities. On the other hand, pro poor tourism expansion is attracting attention as an area that can enhance sustainable development in developing

## **BANKING FOR POOR AS A STRATEGY FOR LOCAL SUSTAINABLE TOURISM DEVELOPMENT**

countries. The findings indicate, at least theoretically, that by combining the banking for poor with the pro poor tourism activities could considerably contribute in the development of local entrepreneurs.

The research is concluding that the expectations of local residents are improved in their living standard and sustainable local development if the barrier to access the needed capital is removed. Moreover, an adequate financing and development strategy should be directed toward the development and financing of the tourism sector value chain. Meaning that, it should not finance only a business plans in one part of the value chain (i.e. building a motel, or a shop). Instead, it should focus on financing a fully developed value chain business plans in which different entrepreneurs would be involved, this is also supporting the achievement of mutual goal. The reason for this, as concluded by the research, is that only when a fully established value chain exists, only then everybody is a winner, the residents, the local economy and the nature.

### **References**

- Akyeampong, O. (2011). Pro-poor tourism: residents' expectations, experiences and perceptions in the Kakum National Park Area of Ghana. *Journal of Sustainable Tourism*, 19(2), 197-213.
- Ashley, C., Boyd, C., and H. Goodwin (2000). Pro-poor tourism: Putting poverty at the heart of the tourism agenda. *Natural Resources Perspective*, 51, 1-6.
- Burgess, R. Pande, R. and G. Wong (2005). Banking for the Poor: Evidence from India. *Journal of the European Economic Association Papers and Proceedings*, 3(2/3), 268-278
- Dillard, J., Dujon, V. and M. King (2009). *Understanding the social dimension of sustainability*. New York: Routledge.
- Dusuki, A. (2008). Banking for the poor: the role of Islamic banking in microfinance initiatives. *Humanomics*, 24(1), 49-66.
- Egger, E. (1986). Banking for the rural poor: Lessons from some innovative savings and credit schemes. *International labor Review*, 125( 4), 447-462.
- Felder-Kuzu, N. (2006) "Micro-Credit, Micro-Franchising, and Women Entrepreneurs", *Realizing Property Rights*, pp. 249 – 252. Sarker, A. (2001). The secrets of success: the Grameen Bank experience in Bangladesh. *Labour and management in development journal*, 2(1), 2-17.
- Gilbert, R. Stevenson, D. Girardet, H. and R. Stren (1996). *Making cities work: The role of local authorities in the urban environment*. London: Earthscan.
- Hinson, R. (2011). Banking the poor: The role of Mobiles. *Journal of Financial Services Marketing*, 15(4), 320-333.
- Jothi, V.N. (2010). Socio-Economic Impact: Microfinancing of Self Help Groups. *SCMS Journal of Indian Management*, January-March, 91-103.
- Khavul, S. (2010). Microfinance: Creating Opportunities for the Poor?. *Academy of Management Perspectives*, 24(3), 58-72.
- Kuzilwa, J. (2005). The role of credit for small business success: A study of the National Entrepreneurship Development Fund in Tanzania. *The Journal of Entrepreneurship*, 14(2), 131-161
- Meyer, R. (2002). The demand for flexible microfinance products: Lessons from Bangladesh. *Journal of International development*, 14(3), 351-368.
- Mirbabayev, B. and M. Shagzatova (2006) "The Economic and Social Impact of Tourism", [http://www.grips.ac.jp/alumni/UzbekistanTourism\(2\).pdf](http://www.grips.ac.jp/alumni/UzbekistanTourism(2).pdf).
- Olu, O. (2009). Impact of microfinance on entrepreneurial development: The case of Nigeria. *The International Conference on Economics and Administration*, ICEA-FAA Bucharest, 14-15th November.

- ProDesarrollo finanzas y microempresa, A.C. (2008). Benchmarking of the microfinance in Mexico: A report on the sector, (30. July, 2012), <<http://www.themix.org/sites/default/files/2008>>
- Regions of the Republic of Macedonia 2012, Regional yearbook, State Statistical Office of the Republic of Macedonia
- Robinson, M. (2001). The Microfinance Revolution: Sustainable Finance for the Poor. Washington D.C.: World Bank Office of the Publisher
- Verica Janeska and Štefan Bojnec (2011) “Rural Labor Market Developments in the Former Yugoslav Republic of Macedonia”, Working Paper No. 5, September, Centre for European Policy Studies.
- Vincent, G. (n.d.). Sustainable Microentrepreneurship: The Roles of Microfinance, Entrepreneurship and Sustainability in Reducing Poverty in Developing Countries, Financing Microenterprises: Theory and Practice, (10. June 2012) <[http://www.gdrc.org/icm/micro/guy\\_sust-micro.pdf](http://www.gdrc.org/icm/micro/guy_sust-micro.pdf)>





# THE IMPORTANCE OF ECONOMIC DEVELOPMENT OF MODERN TOURISM IN SERBIAN RURAL AREAS

Jovica Mojić<sup>1</sup>

Vukašin Šušić<sup>2</sup>

**Abstract:** *Modern tourism follows a tumultuous and intense development, both globally and at the level of individual countries and regions and destinations. The modern tourism industry is based on ideas. In order to develop, must produce, build and use a socio-spatial representations of nature and culture for marketing purposes. Tourism representations must be based on the discourses that produce meanings of places, cultures, attractions and activities in connection with tourism. That the development of modern tourism in Serbia had a better effect, in paper we have identified the potential for its development in rural areas. With the aim to define the importance of economic development of modern tourism in rural areas of Serbia, this paper presents Serbia as a country of diverse and preserved nature, with a priority towards the development of ecological and rural tourism, which has a great chance in the competitive international market. The importance of economic development of modern tourism in Serbia includes the comprehensive evaluation of natural, human and material resources in the so-called pockets of industrialization - the disadvantaged rural areas, which represent a significant factor multifunctional rural development.*

**Keywords:** *modern tourism, rural tourism, economic development, rural areas*

## Introduction

Today it is estimated that tourism with its features into all aspects of social and economic development in many countries. Tourism has expressed direct, indirect and multiplied effect on economic development. That is why in recent years tourism has received much attention especially in terms of its contribution to overall economic development of countries and regions.

Creating and designing tourism today is the same, but much different than the last decade of the twentieth century. The rise of tourism has led to new directions of development of tourism and ways of thinking about the tourist industry. More and more we talk about specific forms of tourism, alternative forms of tourism and special forms of tourism. Tourism takes on new forms and contents so that, according to their motives and needs, develop specific (selective) forms of tourism. Tourism theorists are faced with many new types of tourism-modern movement, which resulted in the creation of different forms of tourism that are not discussed in the last century. The fact that changes in tourism demand brings new habits and new needs that can be realized only through special forms of tourism.

Tourism in the contemporary allows more people from all social classes, to leave so. state of attachment to one location and reach "its imagined events". On the other hand, tourism training and development of resorts allow this sector to be equal with other sectors of the economy. At the same time, the current economic processes eliminate more traditional socio-economic relations and destroy the antagonistic relations between developed and developing countries. All this requires specific forms of investment in the development of tourist destinations, as well as a contemporary form of tourist products of the highest quality.

---

<sup>1</sup> Faculty of Economics, University of Niš, jmojic@sezampro.rs

<sup>2</sup> Faculty of Economics, University of Niš

## **THE IMPORTANCE OF ECONOMIC DEVELOPMENT OF MODERN TOURISM IN SERBIAN RURAL AREAS**

---

Basic features of development and the general importance of rural tourism, the need for the specification of the place and role of this form of tourism, or by defining the response to the question of whether it is just one of the parts / segments of the overall tourism market, or development of rural tourism is a special approach to the overall development in rural areas? The characteristics of demand and supply in the rural tourism suggest that rural tourism is just a part of the overall tourism and tourism market. Properly it would be classified as a form of tourism related to "special interests" (hunting, fishing, hiking, etc.), Which is the opposite of mass tourism, and tourism "organized trips". In this sense, rural tourism is in competition with other forms of tourism and tourism products. The problem arises when trying to define and quantify rural tourism (volume of traffic, revenue, etc.), Which requires the delineation of detail in the approach to rural as opposed to other forms of tourism.

### **Modern trends in the development of rural tourism**

Optimistic estimates of the volume of tourist demand, date, primarily by the UNWTO, include their positive impact on overall relations in the tourism market, given the dominant position of demand in relation to the tourist industry. In this context, as the prevailing tendency of tourist demand, especially in Europe, we can extract:

- refreshing contrast to the (tourist travel between plain-mountain, urban-rural, etc.),
- pursuit of experiences related to cultural and historical heritage and untouched nature, also called alternative, responsible, or modern tourism - refers to tourism in the countryside and in cities. Implies, first of all, clean water, nutritious food and clean air, and that is not mass tourism, but "friendly" oriented towards the natural environment,
- demand for places, events and experiences that have strong identity, integrity and diversity,
- demand for rural (rural) tourism - means staying in different types of accommodation (in rural households) and engaging activities (sports, adventure, challenges, arts, crafts, etc.),
- Demand for health, spiritual, mental rehabilitation and reconstruction of identity - refers to new forms of health and spa tourism: striving for better conditions (recreational activities, sport and exercise, diet, fitness) and the desire for better health by combating stress.

Primary motives for directing tourists to rural areas may be considered as a desire to stay in a preserved natural environment and a sense of freedom, authenticity and tradition, which together result in a feeling of relaxation and tranquility. These incentives are inconsistent with the way of life in urban areas, and represent the antithesis of life in these areas. It seems that the real or presumed "rurality" an important factor that determines the scope and structure of tourism demand to the rural areas, and that tourists are primarily motivated by the overall attractiveness of rural areas not able to participate in certain activities (recreation and other).

### **Managing the development of rural tourism in Serbia**

A special aspect of managing the development of rural tourism is manifested in the need for educating staff. It is understood that tourism development should lead, on the one hand, an increase in employment related to the provision of products and services for tourists and, on the other hand, to provide additional income for existing employees on the basis of seasonal employment. For this to be accomplished in a qualitative manner, it is necessary to educate key stakeholders in meeting the needs of tourists. These are, first of all: the hosts, the owners of houses for rent to tourists, small hotels, restaurants, camping grounds - they should be educated about the needs of tourists, make them into knowledge management, bookkeeping, providing facilities for leisure guests, safety, hygiene methods

for tourists, as well as expand their knowledge about the natural, cultural and other characteristics of their region, the entire local population - to participate in an effective way to achieve a joint project of rural tourism development, staff from the local tourist information centers, local tour guides and entertainers in to acquire a broad knowledge of the characteristics of the area, particularly tourism resources, ways to promote tourism products, leisure and other techniques.

Modern tourism is based on ideas, in many countries is recognized as an opportunity for economic and overall development, and in that direction, and Serbia should be involved. Given the specific situation in which Serbia was in the past few years has lost a significant part of the international market. Current trends and economic relations are changing perceptions of tourism as a global process. This means that tourism is beyond the scope of, "the industry" and becomes a socio-economic phenomenon. Its further development, the formation of products and new destinations are the result of previous experience and new desires for travel consumers. From these factors, tourism is increasingly perceived as 'nostalgic' process. The strong link between tourism and nostalgia is expressed and is particularly associated with historical elements, accommodation, attractions and cultural institutions. It was pointed out that tourists are often strangely fascinated by the tragic and deeply moving historical places. Nostalgia is based on dissatisfaction with social status, present and future. Nostalgic tourism, which provides an alternate reality, creating a refuge in an imaginary past, which people often think that is true. It is believed that the real antithesis of the nostalgic tourism. With the rapid nature of technological innovation and nostalgic trend towards globalization, the traditional rival and antagonistic relationships between business organizations grow in partnership agreements. Many tourism organizations success is dependent on achieving partnerships in order to better serving customers. In such circumstances, the duty of economic, social and political influence, and tourism organizations, to develop a partnership (Milenković, 2006).

Serbia in building the image of an attractive tourist destination has to take a number of activities, which are written by many of our authors in the field of tourism. For faster development of tourism in Serbia, among numerous other activities is very important (Hadžić, 2005):

- investment in high-quality hotel facilities and infrastructure,
- acceleration of the privatization process,
- coordinating the activities of public and private sector involved in tourism development,
- greater involvement of local communities, particularly in developing strategic plans for tourism development at destination,
- participation in international projects in the field of cultural, rural and eco-tourism.

So, one of the main tasks in the development of tourism in Serbia is undertaking the exploration opportunities for the development of new forms of modern tourism, and establish measures for repositioning of Serbia as an attractive tourist destination, especially in rural areas. For this purpose it is necessary to create such tourism products to be competitive and authentic to the tourist market and to enable the formation of a recognizable brand of Serbia as a tourist destination. Certainly the greatest chance for recognition on the tourist market of Serbia can be produced in the cultural, mountain, hunting and eco-tourism, which can be activated in the rural areas.

Goods cultural heritage have the best tourism development when viewed in its entirety with the natural and anthropogenic values in the region. So it would be very useful to perform a thorough analysis of the connectivity of entities rural and urban areas in Serbia, which would contribute to the faster development of tourism in general. Environmental entities in these areas, with valuable cultural and historic resources, provide excellent opportunities for the organization of musical and stage performances and events (events), which can attract large numbers of visitors.

## **THE IMPORTANCE OF ECONOMIC DEVELOPMENT OF MODERN TOURISM IN SERBIAN RURAL AREAS**

---

One of the main prerequisites for the successful planning and management of sustainable development of rural tourism is the active involvement of rural communities and local people in the process. This involvement is necessary because the nature or the natural environment is an essential factor in the overall quality of life of residents of rural areas. Any use of this resource for the purposes of tourism, without the consent of the local community can be assessed by the local population and constitute a misuse disincentives factor in the development of rural tourism.

The existence of equilibrium, or partnership between the number of participants in the development of rural tourism in Serbia, another important factor in the success of planning and managing the development of rural tourism. The focus is primarily the relationship between public and private sectors and between government and quasi-governmental bodies, on the one hand, and, on the other hand, tourism enterprises and other organizations that are directly and indirectly involved in the development of rural tourism. This partnership should result in the inclusion, in the planning and managing the development of rural tourism, the broader social and environmental issues.

Striving for sustainable development of rural tourism means that tourists and actively participate in the overall process, in conformity to their overall behavior goals of development, primarily the protection and preservation of natural environment and cultural and historical heritage. It is about directing the behavior of tourists, and the management mode of use of total resources in rural areas by tourists (visitor management). One of the most common ways to achieve this effect is the official publication of the rules of conduct to tourists, adapting their behavior, assumed some responsibility in protecting the resources of rural tourism.

### **Concept development of rural tourism in Serbia**

Rural areas have a special place as areas of excellence, as well as ecological oases, the fortress of traditional culture and ethnic diversity and cultural heritage. Tourism is one of the activities that can have a significant impact on economic, social, functional and physiognomic structure of rural areas. "Tourism has an important function in the transformation of the physiognomy of the place and function of rural settlements. This phenomenon is a consequence of the increasing needs of the urban population for recreation in a different room, country setting" (Stanković, Ćirković, 2003). Rural tourism is a very broad concept that includes not only home to the village, but all other activities in rural areas.

Derek H., and Greg R., (2002) emphasize the pressure that exists between successful tourism development (which generally means more visitors) and the attractiveness of rural regions (which means peace and quiet).

Rural areas make up about 90 percent of them in Serbia there are about 43 percent of the total population. Rural tourism in Serbia hasn't a long tradition; 70-ies of the 20th century, can be considered the beginnings of development of rural tourism and pioneer village Seča Reka, Sirogojno et al. Although Serbia has a diverse structure of attractiveness, it does not follow the proper profile of tourism products. Before that rural tourism is very rarely appeared in the tourist offer of Serbia. Fragmented and dispersed rural estates, orientation and other forms of mass tourism, lack of awareness about the value of the environment are just some of the factors that influenced the development of the weak form of tourism. Within all the key tourist attractions are designed before the initial offer about 20 years and over. These were the absence of Serbia with the international tourism market in other non-modernized, and thus no greater bargaining power with customers. Inherited tourism superstructure is mainly designed for the domestic tourism market, especially social, youth and children tourism. This is explained by the fact that in former Yugoslavia, the main focus was the development of tourism in the Adriatic tourism (Štetić, 2003).

The main products of today's monitors and the Serbian national statistics are spas with climatic health resort, mountains, and administrative centers. Recently (late 90-ies of the 20th century and early 21st century) in Serbia has been developing a product of rural tourism in different parts of different forms of bids received. Rural tourism in Serbia comprises of tourists to stay in rural households, where agricultural activity and ethnic heritage values and tourism are the reason for the visit of the population of urban areas (Bjeljac, 2004).

In its offer, including rural tourism in various stages of development and different forms of tourism activity (Todorović, Bjeljac, 2007):

- apartments, rural economy, farms,
- outdoor activities,
- eco-tourism,
- cultural tourism,
- event tourism
- gastronomic tourism,
- other combined forms of tourism of special interest.

Tourism, which takes place in rural areas, a significant factor in multifunctional rural development. In the framework of the methodology "multifunctional scheme," which represents the functional interactions within the process of rural development and provide insight in the specific reconfigurations in the use of resources such as land, labor, knowledge and nature (Knickel, Renting 2000), there are four different levels of rural development, which makes farm, rural economy, regions and global space.

Considering the basic postulates of multifunctional scheme, the territory of Serbia are as follows:

- individual households in rural villages, which are specialized and registered for the accommodation of tourists,
- ethno-house that houses the entire economy, built in traditional style of folk architecture,
- ethno-villages, which represent the old village Serbian national engineering and
- landscape units in Serbia, which are clusters of rural tourism.

For the development of a modern tourism in the countryside in Serbia, it is necessary to apply the appropriate standardization and categorization services, particularly in terms of adequate housing. One of the most important tasks in the development of rural tourism, rural education is the host for doing this activity. This would be a great role to have the tourist organization of municipalities, but also all interested entities. First, it is necessary, the curation of domestic and international best practice in tourism in the countryside, indicate village hosts on the economic feasibility of this activity. The achieved level of development of tourism in the country yet the role of animation, or organizing field trips, sporting activities and other cultural, entertainment and recreational activities, taking tourism organization of municipalities, through which performs reservation of accommodation in the villages, which are organized engaged in tourism.

The concept of sustainable tourism development, which is especially important for the development of rural tourism can become the basis of meaningful development of tourism in tourist destinations at all levels if its principles are included in the planning process of tourism development, particularly strategic, and if they are expressed in the strategic development goals. Basic and priority objectives of tourism development in the planning process can be very numerous, varied and conflicting. They can be expressed in economic, social and environmental terms. Acceptance of

awareness of the need for setting strategic goals for tourism development which are broader than economic, implies a greater influence of the public sector, respectively government and quasi-governmental bodies.

### **The importance of economic development of modern tourism in Serbia**

*Tourism is the key to the development of world economy, that is - Tourism, these are jobs, infrastructure and development.* These definitions of tourism by the World Tourism Organization (UNWTO) is the best way to illustrate the significance of these changes and economic activity (fourth overall economic importance!) entered into the world economy.

Tourism, therefore, has a large, and growing importance to the global economy, particularly for the economies of developing countries. This is the reason why this activity is given much attention in the development of tourism are investing significant resources. This specific sectors of the economy is driving the development of other economic activities, particularly infrastructure and agriculture. An important feature of modern tourism, in light of the current economic crisis is his potential to be a driver of economic recovery and increasing the employment of the population.

Tourism is generally given more importance, but also the expectations of tourists are increasing, and their desire for specific experiences. It reflects the special role of development in the tourism industry. Organized events can be triggers development of tourism specific countries / regions since they are an increasingly important factor in making decisions about travel. This affinity stems from modern tourists who want to visit new destinations and through new-modern forms of tourism know-deficient culture have fun and gain new experiences. One of the main characteristics of modern tourism that will forever be remembered as a unique experience for all their visitors. The potentials of Serbia in the field of tourism are very significant. This particularly applies to the possibility of creating tourist products prepared for different categories of tourists and custom current global trends in tourism.

Benefits reflect in the following order parameters:

- The proximity of Serbia emission tourism markets, especially the EU member states;
- Low prices for visitors from abroad;
- Lack of familiarity, but also the attractiveness of Serbia as a tourist destination; variety of solid-preserved natural and manmade heritage;
- Ability to create affordable travel packages for different categories of tourists (youth, seniors, families, business people, adventurers, etc.);
- Great potential for the organization and *City Break* and *Miny Break* tourism;
- Attractiveness and global recognition of Serbian events (which each year attracts an increasing number of visitors).

In Serbia have already confirmed some forms of modern tourism, and some only to be expected with further development. Important among them are: recreation-holiday, sports and recreation, rural, hunting, sightseeing, excursions, cycling, yachting and transit.

- Recreation-holiday, summer and winter tourism is characterized by passive and active recreation domestic tourists. Is associated with summer and winter vacation and recreational sport activities such as swimming, walking, hiking and excursions to the surrounding mountain ranges and a gazebo, and contacts with rural populations, collection of medicinal and aromatic plants, a massive winter sledding and skiing, ski school, etc. This is, otherwise, the most massive form of domestic tourism in Serbia. He will likely retain that significance in the future,

just as its economic effects will vary depending on the equipment and the quality of tourist offer each tourist center in particular, where it could have an interest and foreign tourism, and the combined health and leisure and recreational recovery combined spa-mountain.

- Sport-recreation tourism is also a form of mass tourism, for now the possibility of development of winter sports, or sledding, Nordic skiing and skating on the ice skating rink. In perspective, the construction of sports infrastructure and accommodation facilities, the development will be directed to high-quality offer that would attract tourism and foreign organizations and guests. This could be the most profitable high center of tourism, but one could expect a certain fluctuation in length of winter ski season, as it is, the amount and duration of adequate snow cover, here more volatile than in the high mountains. The use of artificial snow and ice (whose production is foreseen in the Plan, hydrotechnical solution) would be significantly improved and extended the winter tourist season. Summer sports activities, in addition to the standard (tennis, football, basketball, cycling, horseback riding, hiking, etc.) may include the development of so-called. extreme, such as: cross bike, paragliding, sport flying, sailing, etc.
- Rural tourism with certain forms of agro-tourism could become a stable form of tourism, but it will mostly depend on the overall development of specialized forms of agriculture and improving rural living conditions. For rural tourism needs to equip rural households and residents to develop an interest in providing services to tourists, and tourism would have contributed to the improvement and stabilization of these villages.
- Hunting, according to the natural conditions that could become a promising and highly profitable economic and tourist activity, but on condition that, measures of protection and restoration of wildlife populations, improve the capacity of the breeding grounds and the preparation of certain types of wildlife (deer, roe) in fenced hunting. Under these conditions, the hunt could gain characteristics of foreign hunting tourism.
- Sightseeing and excursion tourism with the construction of more tourist centers can become more and more importance and should be found in all school trips itineraries through Serbia.
- Transit tourism in Serbia is in complete dependence on traffic and tourist areas and the position of the quality of roads. Traffic is a peripheral position, and the modernization of roads and contribute to the increased transit traffic.

So, depending on the capabilities of providing financial resources for reconstruction and modernization of existing tourist facilities and roads, to build new facilities, and sport utility infrastructure, as well as the dependence of the material possibilities of encouraging the development of agriculture and other activities, spatial editing and completion of tourist sites and centers, organizational and business connectivity relevant parties on the ground in local communities, will gradually be complete tourist offer of Serbia, and with it will strengthen the current and start a new-modern forms of tourism.

## **Conclusion**

Contemporary concepts of modern and postmodern tourism in the foreground kicked what is called a complete experience in the natural environment, with a return to those positions that these consumers want. All tolerated the development of tourist facilities return travel consumers to request that their vacation means rehabilitation, satisfaction, prestige, and it costs less room.

In order to affirm rural tourism in Serbia, it is necessary training for interested rural households engage in this activity, create tourist points in villages, renovate existing and construct new sports and recreational facilities (jogging trails, hiking trails), to activate the old crafts and cottage industry etc. These steps are the goal of cooperation with UNWTO in the field of rural tourism with the Tourist

organization of Serbia, and competitive ability in this area with the market demands. In this way, the development of rural tourism can stop the negative migration flows from rural areas, carry out resuscitation private sector of agriculture and other activities, and create conditions for the revival of production in some neglected and forgotten traditional occupations based on the processing of agricultural products.

According to the Tourism Development Strategy in Serbia until 2015. rural tourism should be developed in rural areas and promote the domestic market, especially towards the target group of tourists from major cities. Also, it should promote rural tourism in foreign markets, which have already developed an interest in the rural experience.

Finally, global tourism, the new international economic relations, marks the continuation of development in terms of precise redistribution of tourist consumers the major economic, geographic, demographic and personal characteristics.

### References

- Bjeljac, Ž., (2004). *Potencijali i strategija razvoja turizma u Suvoborski kraju*. Zbornik radova sa naučnog skupa "Planiranje i uređenje sela i ruralnih područja", Vrujci, oktobar 2004, Udruženje urbanista Srbije, Beograd.
- Derek, H., and Greg, R., (2002). *Tourism and sustainable community development*. Routledge
- Hadžić, O., (2005). *Kulturni turizam*. Departman za geografiju, turizam i hotelijerstvo, Novi Sad, 289
- Knickel, K. and H. Renting (2000). Methodological and conceptual issues in the study of multifunctionality and rural development. *Sociologia Ruralis*, 40: 512-528.
- Milenković, S., (2006). *Globalni turizam u budućem ekonomskom razvoju*. Časopis Departmana za geografiju, turizam i hotelijerstvo. Novi Sad, Turizam 10/2006: 29
- Stanković, S., и Ćirković S., (2003). *Turistička valorizacija ruralnog prostora*. Zbornik radova sa Drugog foruma: Ruralni turizam i održivi razvoj Balkana. Kragujevac: AEERT
- Todorović, M., Bjeljac, Ž., (2007). *Osnove razvoja ruralnog turizma u Srbiji*. Glasnik srpskog geografskog društva, 2007, sveska LXXXVII, br.1: 144
- Štetić, S., (2001). *Uticaj turizma na ciklične promene ruralnih područja*. Zbornik radova sa Prvog foruma: Ruralni turizam i održivi razvoj Balkana. Kragujevac: AEERT



# ANALYSIS OF BUSINESS PERFORMANCES DURING THE CRISIS PERIOD

Jana Subotić<sup>1</sup>

Ana Vjetrov<sup>2</sup>

Nemanja Vejnović<sup>3</sup>

**Abstract:** *Global economic and financial crisis caught markets and firms unready for the forthcoming problems and changes. In order to understand the challenges companies were facing the main focus of this paper will be on their business performances during the crisis period. The analysis will also include exporting firms, because better strategic positioning of the Serbian exporters may have positive influence on economic growth of the country. However, it is necessary to underline that the crisis increased a long list of challenges that enterprises in Serbia face in their every day functioning. The data that in the first nine months of 2011 number of companies newly established mounted to 6,400 in comparison to the number of 10,000 companies closed during the same period only confirms difficult condition for doing business in Serbia. However incapability of the enterprises to meet their own financial obligation forced them to plunge into new debts. The already mentioned illiquidity of the enterprises is confirmed by the increasing level of nonperforming loans (NPLs) and the corporate sector has the biggest share in the overall number. Crisis revealed the fact that structural reforms have to be finished as soon as possible. Unfinished reforms make business operations harder and more challenging for Serbian enterprises. Analysis of business performances of the enterprises and business environment will provide more realistic prospect how Serbian corporate sector has been functioning during crisis period and what improvements in business environment need to be done.*

**Keywords:** *business performances, corporate sector, loans, financial system, business environment*

## Introduction

Global economic and financial crisis caught markets and firms unready for the forthcoming problems and changes. In order to understand the challenges companies were facing, the main focus of this paper will be on their business performances during the crisis period. The authors decided to analyze the most successful firms following their operating revenues in Serbia, due to the significant role these firms have in Serbian economy. The other financial indicators such as growth of operating revenues, earnings before interest, taxes, depreciation and amortization, EBITDA margin, earnings before taxation, net profit/loss, return on equity, average number of employees, assets, equity, net debt and investment estimation are also presented, in order to provide clearer picture related to the enterprises' performance during crisis period. In section 2 of the paper it is examined how financial and economic crisis affected the Serbian economy and its financial system. Considering the fact that Serbian financial system is bank oriented, banking sector and its key indicators are also included in the analysis as well. Share of NPLs and corporate loans to GDP is presented in section 4. Furthermore, in section 5 the objects of the analysis are the enterprises and their financing. In section 6 closing remarks are given.

---

<sup>1</sup> FEFA, University Singidunum, Belgrade, jsubotic@fefu.edu.rs

<sup>2</sup> FEFA, University Singidunum, Belgrade

<sup>3</sup> Department for Graduate Studies and International Cooperation, University Singidunum, Belgrade

### **Impact of financial crisis on Serbian economy**

The 2007 financial crisis started after real estate bubble burst in United States and caused huge decline in value and trade volume of securities linked to mortgages, spreading negative effects throughout highly integrated global financial system. Money markets were frozen, and lending activity of financial institutions declined affecting liquidity throughout the world. At the beginning of the crisis bank centric financial system in Serbia did not suffer heavy losses. Moreover, investors from Serbia did not directly participated in trade of financial instruments which were backed by mortgages, such as mortgage backed securities and collateralized debt obligations, so Serbian financial system was not directly exposed to effects of fast spreading financial crisis. Furthermore, capital adequacy ratio of Serbian banks was very high, much higher than one of EU countries banks, enabling those banks to remain liquid. According to National Bank of Serbia (2007) out of total 35 banks operating in country, 30 had capital adequacy ratio over 20% in Q4 of 2007 and average capital adequacy ratio for the banking system equaled 27.9%. Value of major stock market index Belex 15 declined more than 80% at the end of 2008 relative to index peak in May 2007. Decline in prices of stocks listed on Belgrade exchange had only marginal effects on economy due to fact that companies in Serbia do not tend to finance their activities by issuing debt or equity securities. Furthermore, most of major companies in Serbia are not publicly traded on Belgrade exchange.

Although financial sector in Serbia did not suffer directly from global financial crisis because of adequately capitalized banks and absence of investments in risky asset backed securities or financial derivatives such as credit default swaps and synthetic collateralized debt obligations, it had been affected indirectly. Great majority of Serbian banks that dominate financial system are owned by foreign banks which were pressured by liquidity issues in their own countries. This situation resulted in decline of funds being available for financing business activities in Serbia as foreign banks operating in Serbia needed those funds to face liquidity problems in their own countries. Also foreign direct investments were reduced as consequence of global financial crisis. This proved to have negative effects on Serbian economy as its growth was highly dependent on this external source of financing. In years prior to global financial crisis foreign direct investments were substituting insufficient domestic investments.

Moreover, funds available for financing business activities in economy were insufficient. This transmitted crisis from financial to real sector of economy. Before the crisis, Serbian economy was mostly import oriented and vast majority of Serbian companies had troubles exporting to highly competitive foreign markets. Economic growth was based on rising demand combined with rising import and services based around import, like transportation, wholesale and financial services. Industrial production was constantly falling each year after crises. Effects of financial crisis were visible both on export and import. As lending activity of banks declined, import and export declined as well. Enterprises had troubles paying their financial obligations, which in combination with reduced domestic and foreign credit supply and more strict and rigid lending approval rules made economy less liquid. Reduction of domestic and foreign demand caused by liquidity problems lead to decline of Serbian export, which was already uncompetitive. Import also declined. Main cause of negative trend is shortage of domestic demand which was expanding rapidly during growth years, but has contracted after origination of financial crisis. Contraction of domestic demand was consequence of low level of liquidity in economy. Amidst new circumstances, firms had to adjust. Resources for funding new activities were limited and enterprises had to pay their past and new debts. Financial crisis become also an economic crisis, so real sector in Serbia had difficulties to adapt to all changes and challenges that crisis brought. Small and medium sized enterprises had big problems with financial obligation, lending and doing business in environment burden with unfinished reforms. On the other side large firms, which are generators of the economy, were out of scope. For this reason, big firms were the subject of the authors analyses, because it is crucial to know how enterprises managed to cope with all pressures that crisis brought.

### **Analysis of thirty largest firms in Serbia**

After presenting the effects the crisis imposed on many countries, the author will try to present the functioning of the companies in Serbia within crisis period. Five years after the beginning of critical and difficult period for markets and enterprises all around the world, corporate sector and especially small and medium sized enterprises in Serbia are struggling to survive. Moreover, small and medium sized enterprises in Serbia, had problems related to doing business on daily basis even before crisis, thus enabling bigger possibility for further increasing of problems within the crisis. Furthermore, we wanted to know how the firms in Serbia were facing all the problems and challenges that crisis brought. The main tool for our analysis is the annual special edition of the ekonom: east media group called TOP 300 Largest Enterprises in Serbia. This edition is really significant, because it shows the list of most successful Serbian firms according to the operating revenues. The list also includes other financial indicators such as growth of operating revenues, earnings before interest, taxes, depreciation and amortization (EBITDA), EBITDA margin (EBITDA/ earnings), earnings before taxation (EBIT margin), net profit/loss, return on equity, average number of employees, assets, equity, net debt and investment estimation. This edition is unique and reliable and for that reason authors decided to use it. Furthermore, the focus of the paper was the analysis of first thirty enterprises from this report from 2006 to 2010. However, the last edition was launched in November 2011, so the last available data are from 2010. We wanted to see how the biggest firms in Serbia coped with the pressures and challenges that crisis brought. The goal of the analysis is to show which firms managed to stay on the list during the crisis period, which new firms appeared for the first time and how they succeed in appearing amidst the crisis, what happened with their operating profit, EBITDA margin and number of employees.

In hindsight, we can say that 2008 in Serbia was the introductory year for the crisis. In 2008 government of Serbia was sure that crisis will not be so severe and that suitable measures could preserve further damage. It is really important to underline, that if crisis had not happened, 2008 could have been a good year for the economy of Serbia. Instead, in the edition TOP 300 (2009) it is stated that the global economic crisis, which some people consider the biggest crisis the world has ever seen, caused the trend of (moderately) positive economic activities from the previous several years to slow down at the end of the last year and then turn into a contraction of economic activities during 2009, with an uncertain impact on further trends. Furthermore, it is essential to say that first affects of crisis were seen in Serbia at the end of 2008. Consequently, thirty biggest firms had relatively good business performance in 2008. Top 30 firms cumulatively had operating profit of 1,478 billion of dinars (RSD) in 2008. In 2007 it was 1,191 billion and in 2006. 1,017 billion RSD. In those three years we see constant growth of operating profit related to the biggest 30 firms in Serbia. In 2009 the same indicator dropped to approximately 1,278 billion RSD, which is consistent with the fact that in 2009 the first affects of crisis were sensed.<sup>4</sup> The first enterprise on the list- NIS in 2008 had growth of operating revenues of 20.7%, EBITDA reached 11,667 million of dinars, EBITDA margin was 3.8%, but enterprise had net result of -4,013 million. In 2008 this firm cut number of employees by 272. Furthermore, NIS was the first on the list also in 2007 and it had higher EBITDA level (13,407 million of dinars) and as it was already mentioned the higher number of employees. (TOP 300, 2007-2011). It is important to stress out, that 2008 is used as a central year of comparison because we Moreover, in 2006 EBITDA margin for thirty biggest firms was 8.8% and growth of operating revenues reached 35.5%. In 2007 EBITDA margin was 9.73% and growth of operating revenues was 26.6. In 2008 the EBITDA margin for first thirty firms was 9.6 percent and growth of operating revenues was 26.27 percent.<sup>5</sup> Consequently, there was slight decrease in 2008 related to both of these indicators. What is interesting EBITDA margin increased from 9.6 in 2008 to 10.2 in 2009, but this is explained by high

<sup>4</sup> The authors did the calculation on the basis of available data from TOP 300 reports from 2007 to 2011.

<sup>5</sup> The authors did the calculation on the basis of available data from TOP 300 reports from 2007 to 2011.

## **ANALYSIS OF BUSINESS PERFORMANCES DURING THE CRISIS PERIOD**

---

EBITDA margin of certain firms like EPS, Telekom, Telenor, PuteviSrbije, Hemofarm, Sintelon which had their margin over 20%. On the other hand, percentage related to the growth of operating revenues decreased from 26.7% in 2008 to 17.7% in 2009. In 2010, EBITDA margin slightly increased to 10.4% and growth of operating revenues increased to 29.6%. At first sight this increase of EBITDA margin and growth of operating revenues can be seen as a sign of recovery from the difficult 2009, but there are other factors, which had influence on revenues. In TOP 300 edition for 2010 it was written: “ Bearing in mind that the growth of operating revenues in 2010 was a largely result of an increase in the price of raw materials (metals, agricultural products and oil derivatives) instead of an improvement in operations, and that there were no considerable developments, either in terms of operation of enterprises that were already on the list, or of the new enterprises in the list-then last year can be deemed as a year of stagnation of the biggest enterprises in Serbia.” (TOP 300, 2011). Considering the previously said, it can be concluded that the biggest enterprises in Serbia faced most difficulties during 2009 concerning indicator operating revenues , however, EBITDA margin increased in that year due to good performance of couple of firms.

After analysing EBITDA margin, operating revenues and growth of operating revenues it is crucial to analyze number of employees and amount of investments in the biggest 30 firms in Serbia. In 2006 total number of employees in 30 biggest enterprises in Serbia was 141,731. In 2007 there was growth of 11,360 employees to 153,091. In 2008 there was decline to 147,523 employees. In 2009 and 2010 decreasing trend continued. In 2009 the 30 biggest firms had 138,820 employees and in 2010 133,876.<sup>6</sup> In comparison with the number of employees in 2007, there was reduction of 19,215 employees. From this it can be concluded that one way for firms to save during the crisis was by reducing the number of employees. This is not surprising, because the layoffs were the common way of reducing cost in many firms in the world, but it is necessary to stress that the high rate of unemployment has the multiply negative effect on the economy of the country.

Furthermore, investment estimation is important indicator as well. In the TOP 300 reports for 2006, 2007 and 2008 this indicator was not included in analysis. In the last two reports that changed and this indicator gain his spot in the analysis. Two years are not enough for any kind of the time series and conclusions in that direction but at least these two years can be compared. In 2009 amount of investments for 30 biggest firms in Serbia was 222.5 billion RSD and in 2010 225.3 billion RSD. This slight increase can be a good sign, but it needs to be stressed that first four firms on the list invested 122.7 billion RSD in 2010.

It is also significant to present the enterprises that succeed to improve their position on the list during the time of uncertainty. In 2009 enterprises Victoria Group and Mercator S made significant jump on the list and entered top ten biggest enterprises in Serbia. Conglomerate Victoria Group from 11<sup>th</sup> place in 2008 jumped to 7<sup>th</sup> and had growth of operating revenue by 39.3%. It was also in TOP 20 listed companies following EBITDA in 2009. Victoria group had smaller net profit in comparison with net profit in 2009, but firm had growth related to number of employees from 1,195 in 2008 to 1,528 in 2009. (TOP 300, 2010). Furthermore, the other firm Mercator S from the retail sector had very good performances during tough 2009. It had remarkable growth of operating revenues (359.5%), high investment, net profit and growth of number of employees from 963 in 2008 to 3625 in 2009. (TOP 300, 2010). As it is said in the report: “For Mercator the previous year was marked by huge investments in the retail trade development, estimated at 294 million Euros, with which this Slovenia’s company took over the leading position in the sector from Idea. Of this amount, about 45 million Euros are direct investments from Slovenia, which allowed them to open 27,000 square meters of new retail locations. “(TOP 300, 2010). Enterprises Tarkett, KoncernFarmakom M.B., Rudnap Group,

---

<sup>6</sup> The authors did the calculation on the basis of available data from TOP 300 reports from 2007 to 2011.

MPC Holding, TigarTyres, MK Group made significant improvement in the list for 2010. It is necessary to underline that KoncernFarmakom M.B, Rudnap Group, MPC Holding and MK group are conglomerates and that diversification of the activities showed its advantages during crisis. For example, The Boston Consulting Group did the research related to conglomerates during crisis and made some really interesting conclusions. In their report “The power of diversified companies during crisis” (2012) it is written: “New research from The Boston Consulting Group and HHL- Leipzig Graduate School of Management demonstrates that diversified companies perform as well as focused companies but have a measurable financial advantage during economic crisis. More critically, the top diversified companies turn this financial edge into a competitive advantage that enables them to outperform their peers and recover rapidly from crisis.” More research should be done about conglomerates in Serbia, so the same conclusion can be drawn, but conglomerate firms in Serbia showed that diversification of activities and solid financial position could be solution during crisis period. One more important thing is that firms as Tarkett, Victoria Group, KoncernFarmakom M.B, TigarTyres and MK Group are also engaged in exporting activities. Tarkett had 79.1% of growth of operating revenues and it was in TOP 20 biggest firms by net income in 2010. KoncernFarmakom M.B. was in TOP 20 related to the indicator growth of operating revenues, EBITDA and EBITDA margin and also got a loan from International Financial Corporation that would additionally strengthen its financial position. (TOP 300, 2011). These firms are just set as the examples of good performances and growth but it is necessary to bear in mind that in TOP thirty biggest firms there are many others successful exporters. We think that exporting firms are important for the future of Serbia, because better strategic positioning of exporters can have positive influence on economic growth of Serbia.

In conclusion, the year 2009 was the tough year for thirty biggest firms in Serbia. Moreover, in 2009 operating revenues declined also as the number of employees decreased as well. On the other side, EBITDA margin in 2009 increased due to outstanding performance of several firms from the list. Analysis showed that some enterprises succeed to improve their performances and to become better ranked on the list during the crisis period. We concluded that conglomerates and conglomerates that are engaged in exporting activity had good results during the 2009 and 2010. These firms should be in the focus of researches and practitioners in the following years.

### **Bank loans in Serbia- the most dominant way of external financing**

Having presented the state of real sector in Serbia, focusing on 30 biggest companies, the paper continues to analyze the banking sector within the country. Moreover, it is important to stress out once again that financial system within the country is bank oriented due to inefficient and shallow financial markets. Furthermore, the late appearance of the institutional investors may have contributed to its inefficiency and this was influenced by the late implementation of the legislation related to investment companies and voluntary pension funds. In addition to this, Bonin et al (2008) describe banking in the transition countries as particularly interesting and stress out that banks rather than equity markets now dominate within financial sector in most transition countries.

Rose et al (2005) argue that the the main role of banks in general is credit issuing with the aim of financing consumption and investments. Moreover, Jovanović (2006) indicates that bank lending is the way of external financing used most frequently in financing various business activities and for many project realizations as well. Seldom companies can depend solely on their own financial means so they have to find another source externally and usually they turned to banks. However, considering the fact that credit risk is one of the most important risks for the bank, a thorough client analysis should be done prior to credit issuing (Barjaktarovic 2009). According to Rose et al (2005) the best way to avoid credit risk is to set clear lending policy within the bank.

Currently there are 33 banks doing business in Serbia (NBS, 2012). Moreover, out of the total number of banks, 21 are in foreign ownership whereas 12 banks are in domestic ownership. The

## ANALYSIS OF BUSINESS PERFORMANCES DURING THE CRISIS PERIOD

foreign banks have a 75% share in overall assets and a 71% share in overall capital of the banking sector. Additionally, Haas et al (2005) pointed out that most of the transitional countries within Central and Eastern Europe regarded foreign strategic investors as a means to improve both the quantity and quality of financial intermediation. The data itself related to the numbers of foreign banks within the Serbian markets may be interpreted as the confirmation of the claim of Haas and the other authors. Having described the Serbian banking sector in a nutshell, following paragraphs are related to the key banking indicators.

### Key banking indicators

The lending activity was steadily growing despite the cyclical oscillation, reaching the level of 1,672 billion RSD in the end of 2011. Such lending growth was certainly influenced by the Agreement called “Vienna Initiative” that was launched at the height of the financial crisis. Consequently, the loans’ growth (comprising 62% out of bank assets) influenced the further growth of banks’ assets. Moreover, assets have been steadily growing during the last 5 years amounting to 2,650 billion RSD in the end of 2011. However, indicator net profit before tax decreased from 25.4 in the end of 2010 to 1.25 billion RSD in the end of 2011. The downfall in key indicator related to profitability was mostly influenced by the expenses related to exchange rate differences and expenses related to indirect write-offs of loans, investments and provisions. Moreover, the increasing level of nonperforming loans (NPLs) indicated the need for restrictiveness in credit issuing. The level of NPLs reached 19 % out of the total number of issued credits by the banking sector in the last quarter of 2011 (NBS, 2012). It is worth mentioning that in the same period last year the NPL share was 16.9%. Accounting for 65% of overall NPL level, corporate NPLs were one of the key factors that pushed up non-performing loans during 2011. On the following graph the share of bank nonperforming loans to GDP and the share of domestic credit to GDP level in both Serbia and the regional countries is presented:

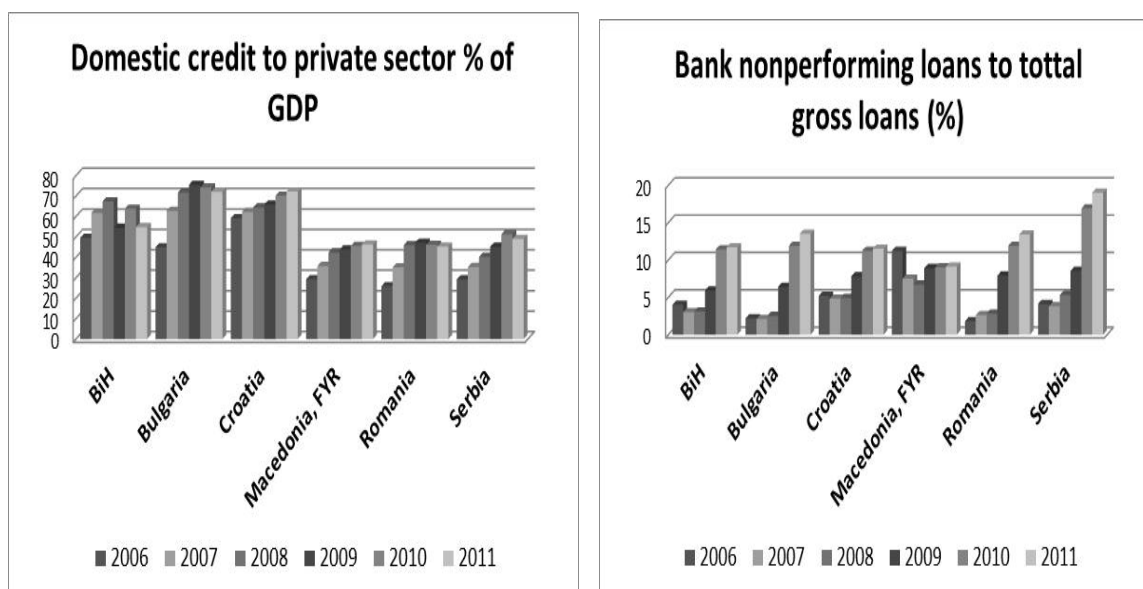

**Graph 1. Share of NPLs and corporate loans to GDP level**

Source: World data Bank, World Development Indicators and Global Development Finance, [http://databank.worldbank.org/ddp/home.do?Step=2&id=4&DisplayAggregation=N&SdmxSupported=Y&CNO=2&SET\\_BRANDING=YES](http://databank.worldbank.org/ddp/home.do?Step=2&id=4&DisplayAggregation=N&SdmxSupported=Y&CNO=2&SET_BRANDING=YES)

The ratio above 50% related to private loans in most of transitional countries in the region confirms the statement given by Bonin et al (2008) that the ratio of bank credit to GDP depends on the financial structure of a country. Furthermore, the authors stated that the ratio will be larger in bank centered financial systems than in countries having more developed capital markets. However, the positioning of Serbia related to the share of NPLs to GDP should be alarming and it clearly points out that the real sector is facing growing indebtedness which may influence the income statements of the banks, especially when it comes to expenses related to write-offs of the loans.

### The enterprises and their financing in Serbia

Having explained the banking sector in Serbia and its functioning within crisis, the object of further analysis are the enterprises and their financing. While explaining the bank oriented external financing of the enterprises, the authors used the report provided by International Finance Corporation (IFC) titled Enterprises Surveys, Serbia Country Profile. The qualitative and quantitative data collected through the already mentioned surveys connect a country's business environment characteristics with firm productivity and performance. Furthermore, the surveys are administrated to a representative sample of firms in the non-agricultural formal private economy. The analysis is conducted through face to face interviews with firm managers and owners regarding the business environment within the country, productivity of the firms and the ways of acquiring necessary capital. For the purpose of the paper only financial aspect of the report is taken into consideration, and the results are shown on the following table:

**Table 1. Financial indicators:**

Finance Indicators	Serbia	Small (1-19 employees)	Medium (20-99)	Large (100+)	EE and CA*
Internal Finance for Investment	52.8	52.7	55.9	45.5	62
Bank Finance for Investment %	30.7	33.6	25.2	31	23.8
Equity, Sale of Stock For Investment %	9.4	10.1	8.7	7.9	8.8
Other Financing for Investment %	0	0	0	0	0.4
Value of Collateral Needed for a Loan (% of Loan )	137.1	116.9	158.6	138.7	133.4
% of Firms With Bank Loans	67.6	60.4	78.5	77.8	43.6
% of Firms With Saving Account	100	100	100	99.9	88.7

Source: International Finance Corporation (2010), Serbia Country Profile, Enterprises Surveys, <http://www.enterprisesurveys.org/~media/FPDKM/EnterpriseSurveys/Documents/Profiles/English/serbia-2009.pdf>

The results point out that the firms mostly rely on internal funds. Consequently, it may reveal the fact related to inefficient financial intermediation within the country. However, within external financing most firms rely on bank loans rather than capital markets. The high value of collateral clearly indicates that the banks are implementing thorough client's analysis, and, consequently, want to secure their receivables within the business climate where increasing number of NPLs is dominating. Furthermore, the third set of indicators focuses on the use of financial services by private



## ANALYSIS OF BUSINESS PERFORMANCES DURING THE CRISIS PERIOD

firms both on the credit side and deposit mobilization side. The results reveal that all the firms in the sample have savings account, and most of them use credit lines provided by the banks.

After presenting the results of the survey conveyed by IFC, the bank financing appears to be the most dominant way of external financing of the companies. Consequently, we will try to establish a possible connection between corporate lending and the level of GDP in the country. Moreover, the mentioned variables and their connection will be presented using linear regression in statistical software MINITAB. Furthermore, the focus of the analysis, where GDP level represents response, while corporate level is used as predictor, is within period from 2001 till 2010. On the following graph the results are shown:

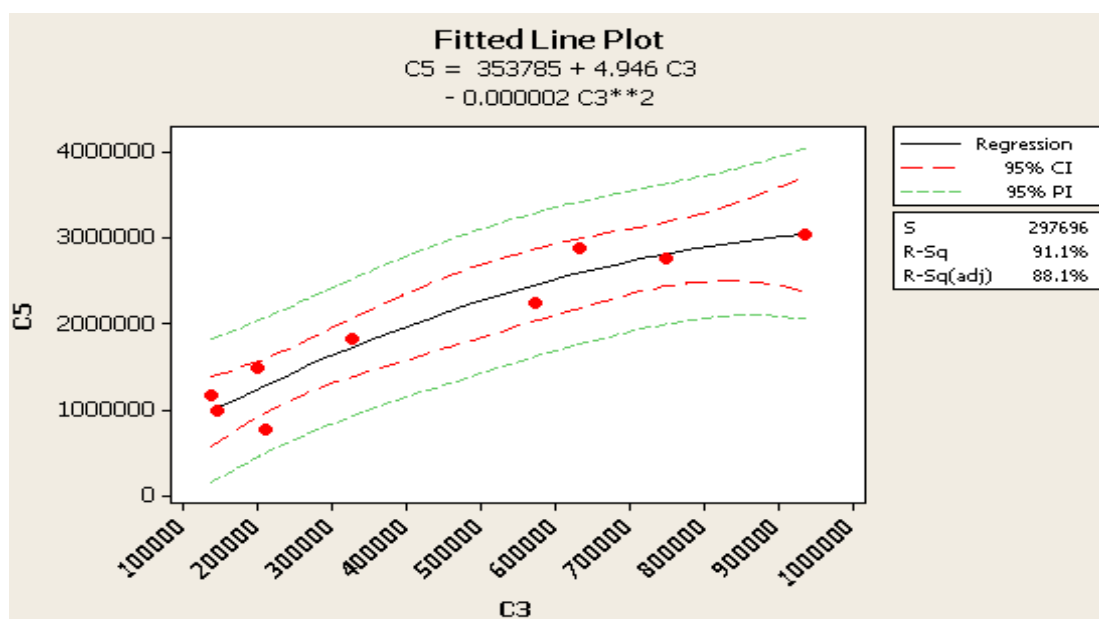

**Graph 2. GDP vs. Corporate lending**

*Source: NBY (2001), NBS (2007, 2008, 2009, 2010)*

It is noticeable that the level of corporate lending influences 88.1% of the variability of the level of GDP. The results clearly stress the role of corporate lending for the overall prosperity of the country and its economic growth, thus, confirming statements of various authors related to the importance of financial intermediation for economic growth. Consequently, a further involvement of capital markets in external financing of the companies has to be priority in Serbia in years to come. However, the illiquidity of the companies within crisis period appears to be the obstacle for further development of financial sector in Serbia, due to its inseparable link with the real sector.

### Conclusion

Economic crisis influenced greatly the real sector within many countries and Serbia representing small open economy was indirectly influenced as well. Moreover, enterprises had troubles paying their financial obligations, which in combination with reduced domestic and foreign credit supply and more strict and rigid lending approval rules made economy less liquid. The analysis showed that even the 30 largest companies faced problems during the crisis periods and unfortunately



they are still facing problems related to illiquidity. However, some companies used crisis period as a chance to grab opportunity and improve their rankings on the regional scale of competitiveness. Unfortunately, the number of enterprises taking advantage to improve the balance sheets is inadequate and small. Investments in research and development and initialization of various innovation programs may appear as a good chance to make the product more competitive. Moreover, diversification of external financing can contribute to easier acquiring of capital necessary for further investments. Consequently, change of people's mentality related to bank oriented financing has to be altered, thus enabling other ways of gaining capital. In the end, it is important to mention that long-term collaboration between banks, clients and educational institutions is essential, as well as the support of international financial institutions. Consequently, this cooperation may strengthen the role of the financial sector in ensuring financial means for enterprises' investment activities.

### Acknowledgments

This Research Paper was the part of the project "Advancing Serbia's Competitiveness in the Process of EU Accession", no. 47028, in the period 2001-2015, financed by the Serbian Ministry of Science and Technological Development.

### References

- Barjaktarovic, L. (2009). *Risk management*, Singidunum University, Belgrade
- Beckmann et al (2012). The power of diversified companies during crises, The Boston Consulting Group, HHP-Leipzig Graduate School of Management, 3.
- Bonin J., Hasan I., Wachtel P.(2008). Banking in Transition Countries, *Oxford Handbook of Banking*.
- Haas R., Lelyved I.(2005). Foreign banks and credit stability in Central and Eastern Europe. A panel data analysis, Elsevier, *Journal of Banking & Finance*, 1927-1952.
- International Finance Corporation (2010). Serbia Country Profile, Enterprises Surveys, <http://www.enterprisesurveys.org/~media/FPDKM/EnterpriseSurveys/Documents/Profiles/English/serbia-2009.pdf> (05 August 2012)
- Jovanovic P (2006). *Investment Management*, Faculty of Organizational Science, Belgrade
- National Bank of Serbia (2006-2012): Banking supervision reports, [www document] [http://www.nbs.rs/internet/cirilica/55/55\\_4/index.html](http://www.nbs.rs/internet/cirilica/55/55_4/index.html) (10 August 2012).
- Report on small and medium-sized enterprises and entrepreneurship 2010 (2011). Ministry of Economic and Regional Development National Agency for Regional Development, Belgrade, 7.
- Rose P. and Hudgins S. (2005). *Banks Management and Financial Services*, Data Status, Belgrade
- TOP 300 Largest Enterprises in Serbia (2007-2011). Annual special edition of the ekonom: east media group, Vol.3, 19-20; Vol.4, 22-23; Vol.5, 14, 20-21; Vol.6, 22-23,75; Vol.7, 14, 24-25,40-41,45-47.



# EFFECTS OF FINANCIAL FLOWS UNDER GLOBALIZATION IN DEVELOPING COUNTRIES

Danijel Kokanović<sup>1</sup>

Marina Stefanović Grubor<sup>2</sup>

**Abstract:** *In today's world economy it is evident that financial flows are the main source of capital allocation and growth between developed and developing countries. This text discusses some benefits and risks that financial globalization provides for developing countries. Effects of financial globalization can lead to some large benefits, especially to the development of the financial system in developing countries. On the other hand, financial globalization can also come with financial crises and negative impact on economic cycle. In the long run, positive effects of financial globalization are likely to overcome negative effects. As the financial liberalization of the national economy is in progress, there are many risks standing ahead to positive effects of liberated financial flows. As financial systems turn global, governments lose their policy instruments and come to unified forms of international financial cooperation, so only some countries, sectors, and companies have taken advantage of globalization.*

**Keywords:** *financial globalization, financial flows, developing countries, financial liberalization*

## Introduction

In world's economy today, we are able to claim that any specific economic system is coloured by various influence of financial globalization. This diverse influence varies regarding to qualitative and quantitative parameters that reflects on global level, whether specific country is ready to use its benefits or not. Reflection of efficiency of specific economic system is related to positive impact and wider usage of advantages of financial globalization. The topic of financial globalization is vital, especially for developing countries, because in understanding mechanism of financial globalization we are able to explain how advanced countries have seen the most rapid increases in financial flows over the past two decades, but emerging markets and developing countries have also become financially more integrated. Yet, there are more potentials of financial globalization to explore for developing countries in the future. This work is primarily discussing some issues like is financial globalization primarily an opportunity to share risk internationally and finance investment projects that are good for economic growth, or is it a source of possible volatility and crisis? Entire dispute among economists is whether is financial globalization threat or opportunity for specific country.

The primary goal of this work is to review the large literature focusing on various implications that could help developing economies effectively manage the process of financial globalization. The recent wave of globalization has generated an intense debate among economists, attracting both strong supporters and opponents. This paper outlines the benefits and risks (especially in periods of crises), that are implied by financial globalization in developing countries. The paper revisits the arguments and evidence that can be used in favor and against globalization, as well as the policy options. In this paper, financial globalization is understood as the integration of a country's local financial system with international financial markets and institutions. This integration typically requires that governments liberalize the domestic financial sector and the capital account. Integration takes place when liberalized

---

<sup>1</sup> Faculty of Economics Subotica, University of Novi Sad, kokanovicdanijel@gmail.com;

<sup>2</sup> Faculty of Information Technology, Metropolitan University, Niš, marina.stefanovic87@gmail.com

economies experience an increase in cross-country capital movement, including an active participation of local borrowers and lenders in international markets and a widespread use of international financial intermediaries. Although developed countries are the most active participants in the financial globalization process, developing countries (primarily middle-income countries) have also started to participate. This paper focuses on the integration of developing countries with the international financial system.

For successful integration, economic fundamentals need to be and remain strong. Financial globalization tends to intensify a country's sensitivities to foreign shocks. Moreover, international market imperfections, such as herding, panics, and boom-bust cycles, and the fluctuating nature of capital flows can lead to crises and contagion, even in countries with good economic fundamentals. Another risk of globalization is the segmentation that it can create between those able to participate in the global financial system and those that need to rely on domestic financial sectors. The net benefit of financial globalization for developing countries can be large, even despite the risks. But globalization also poses new challenges for policymakers. One main challenge is to manage financial globalization in a way that countries can take full advantage of the opportunities it generates, while minimizing the risks it implies. This is important because financial globalization is likely to deepen over time, led by its potential benefits. Another challenge of globalization is that, in a more integrated world, governments are left with fewer policy instruments. Thus, some type of international financial cooperation becomes more important.

The organization of this paper is as follows. Section 2 discusses some key points in cost benefit analysis. Section 3 studies the financial globalization in time. Section 4 analyzes the effects of financial globalization on the domestic financial sector. Section 5 analyzes risks and benefits of the financial globalization. Section 6 discusses major factors of efficient financial flows. Section 7 argues some potential threats that developing economies should be aware when opening up their economies, and finally section 8 concludes and discusses the policy implications.

### **Key points in cost benefit analysis**

Should financial globalization, be viewed primarily as an opportunity for countries to finance investment projects that are good for growth, or as a source of possible volatility and crises caused by sudden reversals in capital flows? In the past decades, there has been many research organized by national and international organizations trying to explain positive and negative impact of financial globalization in national economies. In this paper, analysis of IMF seems to be the most adequate starting point. There are few major implications based upon research in past 30 years for developing countries to carefully consider.<sup>3</sup>

First of all, the findings of the IMF analysis support the view that countries need to carefully weigh the risks and benefits of free capital flows. Whereas advanced economies largely benefit from the free movement of capital, emerging market and developing countries should make sure they meet certain thresholds, which include the quality of their institutions and policymaking and their level of domestic financial development before they open up their capital account. If they do not meet such thresholds, financial liberalization can lead to macroeconomic volatility. This is very important characteristic for majority of the countries of ex SFRY, including Serbia, because transition period from socialist economic environment toward modern competitive economy has not been finished yet.

Second, there are significant level of costs associated with being overly cautious about capital flows. Opening up the economy to outside investment may in itself encourage changes that are good for efficiency and growth, for instance by stimulating development of the domestic financial

---

<sup>3</sup> IMF, Research Department, "Reaping the Benefits of Financial Globalization," 2007.

sector. Financial globalization is clearly a matter of considerable policy relevance, especially with major economies<sup>4</sup> recently taking steps to open up their capital accounts. Large number of developing countries are still in the early stages of financial globalization facing numerous policy decisions about the timing and pace of further integration. The stakes for such policy decisions are high because financial globalization is often blamed for economic crises that rocked a number of emerging markets in the late 1980s in Latin America and in the 1990s in Mexico, but also in Asia and Central and Eastern European (CEE) countries, including Serbia. The market turbulence and resulting bankruptcies have given grounds to claim that developing countries had relaxed capital controls too hastily, leaving themselves vulnerable to the harsh dictates of rapid capital movements and market herd effects. CEE countries have banking sectors that are overwhelmingly foreign-owned. With the de-globalisation and repatriation of the cross-border banking sector, parent banks (mainly in Western Europe) have become progressively less able and less willing to finance their subsidiaries in CEE. The resulting financial stresses in the host countries have led the European central bank (ECB) to take the extremely unusual step of making swap facilities in 2009. to the central banks of two non-Eurozone EU members, Hungary and Poland.

Moreover, financial globalization is also a fascinating topic to study for researchers of development economics not only because of its policy relevance, but because of the enormous variation of approaches and experiences across countries. There has been an explosion of research in this area over the past two decades. Most of this work is relatively recent, since the latest wave of financial globalization got started in the mid-1980s.

### **Financial flows and financial liberalization in time**

The volume of financial flows has risen substantially during the past two decades. Not only has there been a much greater volume of flows among advanced countries over this period but there has also been a surge in flows between advanced and developing countries. There are important differences across country groups in the relative importance of different types of inflows, although there has been a broad shift away from debt financing towards FDI (Foreign direct investments) and equity flows in all groups. The survey of the rapidly evolving literature on issues of financial globalization also reveals that newer approaches depart from the standard neoclassical framework that largely guided the earlier studies. In particular, the earlier literature viewed the key benefit of financial globalization as arising from long-term net flows of capital from advanced to developing economies. Since the former group of countries is capital rich while the latter is relatively capital poor, this should generate higher growth in developing economies and welfare gains for both groups. Perhaps not surprisingly, in light of the corresponding literature on growth in closed economies, this literature often found conflicting results. The benefits are not simply the result of enhanced access to financing for domestic investment. Therefore, financial openness can in many circumstances promote development of the domestic financial sector, impose discipline on macroeconomic policies, generate efficiency gains among domestic firms by exposing them to competition from foreign entrants, and unleash forces that result in better competitive environment.

From a historical view, financial globalization is not a new phenomenon, but today's depth and wideness were unpredictable. Capital flows have existed for a long time. In fact, according to some measures, the extent of capital mobility and capital flows a hundred years ago is comparable to today's. At that time, however, only few countries and sectors participated in financial globalization. Capital

---

<sup>4</sup> Especially BRIKs-countries (Brasil, Russia, India, China)-Goldman Sachs economist Jim O'Neill argues that the economic potential of BRIKs countries is such that they could become among the four most dominant economies by the year 2050.

flows tended to follow migration and were generally directed towards supporting trade flows. For the most part, capital flows took the form of bonds and they were of a long-term nature. International investment was dominated by a small number of multinational companies, and financial intermediation was concentrated on a few family groups. The international system was dominated by the Gold standard, according to which gold backed national currencies. The advent of the First World War represented the first blow to this wave of financial globalization, which was followed by a period of instability and crises ultimately leading to the Great Depression and the Second World War. After these events, governments reversed financial globalization imposing capital controls to regain monetary policy autonomy. Capital flows reached an all time low during the 1950s and 1960s. The international system was dominated by the Bretton Woods system of fixed but adjustable exchange rates, limited capital mobility, and autonomous monetary policies. As a result of the oil shock and the breakup of the Bretton Woods system, developing countries are all low- and middle-income countries as defined by the World Bank. Emerging markets are middle-income developing countries. New wave of globalization began after the breakup of the Bretton Woods system. The oil shock provided international banks with fresh funds to invest in developing countries. These funds were used mainly to finance public debt in the form of syndicated loans. These surpluses were profitably invested in other nations. Alternatively, the world economy would have contracted if that money was withdrawn from the world economy while the exporting nations needed to be able to profitably invest to preserve their wealth for the future.<sup>5</sup> Recycling petrodollars caused problems especially for oil-importing countries that were paying much greater prices for oil and incurring debts. IMF estimates that the foreign debts of 100 developing countries increased by 150% between 1973. and 1977.<sup>6</sup> From 1974. to the end of 1981., total current account surpluses for all members of OPEC (Organization of Petrol Exporting Countries) amounted over 450 billion USD. Ninety percent of this surplus was accumulated by the Arab countries of the Persian Gulf, Libya and Iran. The petrodollars were invested by commercial banks in the USA and Europe. As the recessionary condition of the world economy made investment in corporations less attractive, bankers lent the money to developing countries especially in Central and South America such as Brazil, Argentina and Mexico as well as other developing countries like Turkey. The 1973 OPEC crisis had created a vast dollar shortage in these countries, however, they still needed to finance their oil imports. In subsequent decades, some of these nations have had difficulty in repaying these debts, this process also contributed to the growth of the Euromoney market as a rival to US monetary markets.

With the disintegration of the Bretton Woods system of fixed exchange rates, countries were able to open up to greater capital mobility while keeping the autonomy of their monetary policies. The capital flows of the 1970s and early 1980s to developing countries preceded the debt crisis that started in Mexico in 1982. Deregulation, privatization, and advances in technology made FDI and equity investments in emerging markets more attractive to firms and households in developed countries. Investment boom in 1990s in FDI and portfolio flows led to emerging markets. Today, despite the perception of increasing financial globalization, the international financial system is far from being perfectly integrated.

### **Financial globalization and development of the domestic financial sector**

Financial globalization can lead to the development of the financial system. A well functioning financial sector provides funds to borrowers (households, firms, and governments) who have productive investment opportunities. Financial systems do not usually operate as desired because lenders confront problems of asymmetric information, which can lead to adverse selection and

---

<sup>5</sup> Entire process was known in literature as "recycling petrodollars"

<sup>6</sup> Johan Witteveen, the Managing Director of the IMF, said in 1974, "the international monetary system is facing its most difficult period since the 1930s."

moral hazard. Financial globalization can help improve the functioning of the financial system through two main channels. Actually, financial globalization provides both quantitative and qualitative aspects of financial flow. First, financial globalization can increase the availability of funds. Second, financial globalization can improve the financial infrastructure, what can reduce the problem of asymmetric information. As a consequence, financial globalization can potentially decrease adverse selection and moral hazard, enhancing the availability of credit.

The effects of capital flows on financial development take place because new sources of funds and more capital become available. New sources of funds mean that borrowers not only depend on domestic funds, they can also borrow from foreign countries willing to invest in domestic assets. The capital available from new sources means that market discipline is now stronger both at the macroeconomic level and at the financial sector level, as now local and foreign investors enforce market discipline on private and public borrowers.

Capital markets have developed, in the sense that more domestic equity and bonds are issued and traded, but this does not imply that all domestic financial institutions have become more important. Borrowers and investors can just use international financial intermediaries, like stock exchanges and banks, to conduct their financial transactions. In fact, domestic financial institutions can actually shrink due to competition with international financial institutions. For example, local banks obtain a lower share of the domestic market, so after the entrance of foreign banks in the countries of ex SFRY, at first in Slovenia and Croatia, later in Serbia, foreign banks have obtained and sustained the major market share. The second channel is that financial globalization can improve the financial infrastructure. An improved financial sector infrastructure means that borrowers and lenders operate in a more transparent, competitive, and efficient financial system. In this environment, problems of asymmetric information are minimized and credit is maximized.

Improvements in the financial sector infrastructure could be achieved in many ways. First, financial globalization can lead to a greater competition in the provision of funds, which can generate efficiency gains. Second, the adoption of international accounting standards can increase transparency. Third, the introduction of international financial intermediaries would push the financial sector towards the international frontier. Also, financial globalization improves corporate governance or increase in the technical capabilities for engaging in precision financing results in a growing completeness of local and global markets. As mentioned above, foreign bank entry<sup>7</sup> is another way through which financial globalization can improve the financial infrastructure of developing countries.

### **Some risks and benefits of financial globalization**

The potential benefits of financial globalization will likely lead to a more financially interconnected world and a deeper degree of financial integration of developing countries with international financial markets. The main benefit of financial globalization for developing countries is the development of their financial system, what involves more complete, deeper, more stable, and better regulated financial markets. Better functioning financial system with more credit is key factor because it encourages economic growth.

Financial globalization also carries some important risks. These risks are more likely to appear in the short run, when countries open up. One well known risk is that globalization can be related to financial crises. The cases of the 1997-98 Asian and Russian crises, as well as Brazil 1999, Turkey

---

<sup>7</sup> Mishkin (2000) argues that foreign banks enhance financial development for at least three main reasons: diversified portfolios as they have access to sources of funds from all over the world, foreign entry can lead to the adoption of best practices in the banking industry, and if foreign banks dominate the banking sector governments are less likely to bail out banks when they have solvency problems.

and Argentina 2001 are just some examples that captured worldwide interest. If market fundamentals decline, speculative attacks will occur with capital outflows generated by both domestic and foreign investors. For successful integration, economic fundamentals need to be and remain strong. Local markets need to be properly regulated and supervised. Moreover, international market imperfections, such as herding, panics, and boom-bust cycles, and the fluctuating nature of capital flows can lead to crises and contagion, even in countries with good economic fundamentals. Another risk of globalization is the segmentation that it can create between those able to participate in the global financial system and those that need to rely on domestic financial sectors.

The net benefit of financial globalization for developing countries can be large, even despite the risks. But globalization also poses new challenges for policymakers. One main challenge is to manage financial globalization in a way that countries can take full advantage of the opportunities it generates, while minimizing the risks it implies. Another challenge of globalization is that, in a more integrated world, governments are left with fewer policy instruments. Thus, some type of international financial cooperation becomes more important and there could be opportunity offered by EU candidate status for Serbia amongst other countries in the Balkans.

### **Major factors of efficient financial flows**

In theory, opening up the economy to investment from abroad should have largely positive effects. Financial globalization encourages international risk sharing, stabilizes spending by households and the government, by allowing international capital to supplement domestic capital when there is a shortage of revenue, and also encourages economic growth. In practice, however, the benefits have been less visible. Although advanced countries have benefited from risk sharing, there is little evidence that the same is true for emerging market and developing countries. As international financial integration has increased so has volatility, but only in those countries with relatively weak domestic financial sectors and institutions. In terms of growth, the evidence is also mixed. Whereas FDI does encourage long-run growth<sup>8</sup>, the impact of debt on growth depends on whether the money is put to good use, which in turn is influenced by the quality of a country's policies and institutions. By putting FDI into productive and developing projects, not into increasing unsustainable level of personal and government consumption, there is opportunity for developing countries, such as Serbia, to move to higher level of economic welfare. So far, enormous amount of capital inflow in Serbia, after political changes in year 2000., have been wasted potential due to unproductive usage, high and unsustainable level of consumption and most of all, wide spread corruption. Question is how to make things run better in the future, so in following text there will be stated some key factors that may improve positive effects of financial globalization such as:

- **Developed financial sector.** Well developed financial markets may help moderate boom-bust cycles and to minimize shocks such as waves and sudden stops in financial flows.
- **High quality of institution.** Strong institutions including the rule of law, freedom from corruption, and government efficiency generally play an important role in directing financial flows toward FDI and portfolio equity. A sound institutional framework thus makes it easier to share risk internationally and supports economic growth.
- **Sound and long term oriented macroeconomic policies.** If macroeconomic policies are weak, financial openness may result in excessive borrowing and debt accumulation, thereby increasing the risk of debt crisis.<sup>9</sup> Short term oriented (even daily based interests of political parties) and

---

<sup>8</sup> Average increase in FDI of 10 percentage points of GDP increases growth by 0.3 percentage points on average- Source IMF

<sup>9</sup> This seems to be major missing factor, among others, that disabled countries of former SFRY to move faster toward EU integrations.



lack of responsibility of policy makers in transition economies, have seriously damaged not only present but also future generation.

- **Trade integration.** Countries that are open to trade are less likely to experience sudden stops in inflows. Openness to trade can also mitigate the effects of a crisis by facilitating economic recovery.

Financial crises are, less frequent in financially open economies than in economies that restrict capital flows. Financially open countries with well-developed domestic financial systems, strong institutions, sound policies, and open trade have an even lower risk of experiencing a crisis. Above mentioned effective fundamentals of financial globalization are still primary goal of developing economies, and actual financial and debt crises have proven such standings.

### **Potential threats for opening up economies**

While countries should proceed with caution when it comes to opening up their economies to capital flows, policymakers should also bear in mind that keeping capital controls in place can impose significant costs on the economy. These various costs include:

- **Lower level of international trade.** Capital controls encourage fraud through mis-invoicing. And new research suggests that capital controls increase the cost of engaging in international trade even for firms that do not seek to evade capital controls.
- **Higher cost of capital.** Capital controls make it more difficult and expensive for small firms to raise capital. The cost of borrowing is also higher for multinational companies located in countries with capital controls than in countries without them.
- **Distortions in the economy.** Economic behavior is likely to be distorted by capital controls as individuals and firms seek ways to evade the measures. This may result in an uneven playing field in which well-connected firms, rather than the most efficient ones, survive. This issue is connected with system corruption, in which “best connected”(but not the best) companies enlarge their position and lower nations efficiency of financial flow usage.
- **Administrative costs.** The government has to spend significant resources on monitoring compliance with capital controls and on updating them to close specific holes and limit evasion.

These additional costs are important for developing countries especially in early stage of opening up their economies because their level of efficiency is rather lower compared to developed countries. In general, capital account liberalization should be pursued as part of a broader reform package encompassing a country's macroeconomic policy framework, domestic financial system, and prudential regulation.

### **Conclusion**

In the last decades, countries around the world have become more financially integrated, driven by the potential benefits of financial globalization. One of the main benefits of financial globalization is the development of the financial sector. Financial markets become deeper and more sophisticated when they integrate with world markets, increasing the financial alternatives for borrowers and investors. Financial markets operating in a global environment enable international risk diversification. The crises of the 1990s, after many countries liberalized their financial system, have questioned in part the gains of globalization. Countries become exposed to external shocks and crises, not only generated

## **EFFECTS OF FINANCIAL FLOWS UNDER GLOBALIZATION IN DEVELOPING COUNTRIES**

---

in their own country, but also from contagion effects. In the initial stages of liberalization, if the right infrastructure is not put in place, financial liberalization can lead to increased risks. Moreover, in a financially integrated economy, policymakers have fewer policy instruments to conduct economic policy.

The recent experiences with financial globalization has indicated some useful lessons for policymaking. First of all, developing countries can benefit more from financial globalization and countries should take advantage of it. Financial liberalization can have positive effects on the financial system. At the same time, the evidence does not suggest that financial volatility increases after financial liberalization. Though the potential benefits can be large, we are far from full financial globalization. Also governments should have in mind that sound macroeconomic and financial fundamentals are key in lowering the probability of crises and contagion and to be able to manage crises more effectively. Preventing currency and banking crises should be one of the primary objectives of any policymaker because of the high cost of crises. This is more important in a world of free capital mobility, because both foreign and domestic investors exercise market discipline and because foreign crises might have contagion effects at home. Weak fundamentals tend to scare investors more easily and make crisis management more difficult. Countries with bad fundamentals, for example with large fiscal deficits and public debt, have fewer instruments to use in the midst of a crisis. Therefore, countries should focus on key policies that help them prevent and manage crises. These policies include avoiding large current account deficits financed through short-term private capital inflows and large asset-liability currency mismatches. Since former countries of ex SFRY, in general, haven't reached GDP per capita before civil war started in 1990's, seems that two past decades have been lost for this region. In the future, many opportunities are waiting to be explored, but only if lessons, mentioned above, are fully aware by current and future policy-makers.

Improving the contractual and regulatory environment is also important. Better institutions make an emerging country more fit to join in the financial globalization process. Initial conditions matter because if the domestic financial sector does not manage risk properly, does not have sufficient reserves and capital, or does not have the right incentives, large capital inflows and outflows can create severe problems. As economies become more integrated, governments have less policy instruments and have to rely more on international financial policies. Moreover, bank regulation and supervision by one government is more difficult when liabilities and prices are denominated in foreign currency and when the banking sector is part of an international banking system.

Opening up to FDI is beneficial for almost all countries, even those with relatively weak fundamentals. But before liberalizing other types of flows, countries need to carefully consider whether they meet the thresholds beyond which the net benefits of financial globalization become positive. In sum, all countries should aim to embrace financial globalization. But before opening up their capital account, governments should examine the readiness of their financial sector and their level of institutional development. At the same time, they should also weigh the possible risks involved in opening up to capital flows against the efficiency costs associated with capital controls.

### **References**

#### Books/Edited Volumes:

- Mishkin F.S. (2006). *The Next Great Globalization*. Princeton: Princeton University Press.
- Mishkin F.S. et al. (2000). *Financial Policies, Economic and Financial Crises in Emerging Countries*. Chicago: University of Chicago Press.
- Prasad E.S. et al. (2003). *Effects of financial globalization*, Washington D.C., IMF.
- Stiglitz, J. E., (1989) "Using Tax Policy To Curb Speculative Short-Term Trading," *Journal of Financial Services Research (Norwell, Massachusetts)*, Vol. 3, 101-115.

Articles:

- Bernanke, B., and Mishkin, F., 1997, "Inflation Targeting: A New Policy Framework for Monetary Policy?" *The Journal of Economic Perspectives*, 97-116.
- Kaminsky, G., and C. Reinhart, 2000, "On Crises, Contagion, and Confusion," *Journal of International Economics*, 145-168.
- Mundell, R., 2000, "A Reconsideration of the 20th Century," *American Economic Review*, 327-340.
- Stiglitz, J., 2000, "Capital Market Liberalization, Economic Growth, and Instability," *World Development*, 1075-1086.
- World Bank, 2001, *Finance for Growth: Policy Choices in a Volatile World, Policy Research Report*. Source: World Bank, World Development Indicators 2003 (WDI)



# **ACCOUNTING AND BUSINESS FINANCE**



## FINANCIAL REPORTING STANDARDS: THE ESSENCE AND SOCIAL ROLE

Vladimir Obradović<sup>1</sup>

Radoslav Stefanović<sup>2</sup>

**Abstract:** *Today, the need for financial reporting standards, as the principles and rules that companies have to follow in preparing their general-purpose financial statements, is indisputable. That need is a result of considerable importance of financial reporting for efficient and effective functioning of capital markets, which is, in turn, one of the most important prerequisites for financial stability and growth of an economy and thus well-being of a society as a whole, and inability of market forces to provide enough relevant, reliable and comparable financial information for investors and creditors. High-quality financial reporting standards determine the types of reported information and the principles and rules of their creation and thus increase the efficiency of capital markets and corporate governance system, and thus provide a contribution to raising the level of social well-being.*

**Keywords:** *accounting; financial reporting; standards; capital market; corporate governance*

Financial statements, as the main channel for communication of financial information, are an important mechanism in the functioning of capital markets. Thereby, they contribute to the achievement of social well-being, which is the ultimate goal of every society. In fact, a sound economy is a significant factor of the social well-being. Although many factors contribute to a sound economy (such as abundance of natural resources, a stable political system and appropriate work ethic), one of the most significant factor is undoubtedly the availability of sufficient sources of capital, without which products and services could not be created or distributed. The availability of sufficient capital resources is primarily provided through effective capital markets, which, by establishing the link between those who need capital and those who are willing to make it available, facilitate rational allocation of scarce social capital to alternative uses. The effective functioning of capital markets, however, is not possible without proper decisions of investors and creditors, who need relevant, reliable, comparable, and understandable financial information. The main sources of such information are financial statements, through which the managers of companies that use capital communicate with investors and creditors (Carcello, 2007).

An empirical study, which focuses on the information needs of European investors and creditors and usefulness of financial information available to them, undoubtedly revealed the importance of financial reporting for capital market participants, and thus efficiency and effectiveness of capital markets. The study shows that financial statements and management commentary are the preferred sources of information necessary for making investment and credit decisions (PricewaterhouseCoopers, 2009).

Today, financial reporting is considered a key segment of corporate governance, as "the system by which companies are directed and controlled" (Choi and Meek, 2008, p. 179). The issues of corporate governance and financial reporting are inextricably related. The specificity of that relationship is that the information provided by financial reporting is not only necessary input to the process of corporate governance but at the same time the product of that process.

---

<sup>1</sup> Faculty of Economics, University of Kragujevac, vobradovic@kg.ac.rs

<sup>2</sup> Faculty of Economics, University of Kragujevac

### The need for regulation of financial reporting

With respect to the previously identified importance of financial reporting, it is obvious why companies prepare financial statements, which are then audited and published. They began to do it even before the establishment of formal (state) requirements. The obligation of preparing and publication of audited financial statements stemmed from their statutes or lending contracts (Watts and Zimmerman, 1987). For example, in the 19 century, some British companies, notwithstanding the lack of financial reporting standards, voluntarily published audited financial information, as well as some companies in the United States before the establishment of the Securities and Exchange Commission (Nobes and Parker, 2010).

All unofficial (private) incentives to create and publish information in the form of audited financial statements can be divided into:

1. incentives from individual stakeholders – *individual requirements*; and
2. incentives created by market forces – *market-based incentives*.

Individual financial information requirements arise from the contractual arrangements concluded by a company or its management. This information serves as a basis for monitoring compliance with the contractual arrangements whereas the types of information that have to be reported and the principles and rules (accounting methods) of their generating are subject to agreement of interested parties. In the case of lack of contracted information or failure to predefine accounting methods, the realization of the entire contract would be hindered or disabled, so the contracting parties would be damaged. Individual (contractual) incentives to create accounting information could come from any stakeholder, such as shareholder (investor), creditor, employee, supplier, or customer.

Market-based incentives for accounting information disclosure arise from the expectation that comprehensive and high-quality information contribute to increasing the confidence of investors and creditors in companies. The growing confidence of investors and creditors increases the likelihood of accepting higher prices of shares and bonds issued by companies, which results in lower cost of capital for companies. Therefore, it can be expected that managers, in order to minimize the cost of capital and increase firm value, strive to present complete and reliable information to capital market participants. If managers disclose false information or fail to disclose some relevant information, they can threaten not only the value of their firm, but also their own reputation and market value.

It is undisputable that the requirements of individual stakeholders and the market mechanism provide strong incentives for publication (disclosure) of high-quality accounting information. However, the generation, auditing, and publication of accounting information bring costs to companies. Therefore, it can be expected that, in the absence of regulation (standards) of financial reporting, management would generate and disclose information only in the case of assessment that, from the viewpoint of their companies, the benefits arising from public availability of the information is higher than the related costs. In this regard, the question is whether the managers' perception of the relationship between benefits and costs of information disclosure corresponds to the relationship of benefits and costs from the viewpoint of the society as a whole. The need for regulation of financial reporting directly depends on the answer to the previous question.

Accounting information is a public welfare. Use of information by one person does not lead to its destruction, which means that it remains available for other people. In accounting literature, this effect is called the *free-riding*. Disclosure of information by one company does not only affect its own market position and costs of capital, but also could affect other companies, and thus society as a whole. These and similar effects are called *externalities*. The essence of externalities is that information disclosure by one company can bring costs or benefit to another company, whereas the disclosing company is not charged or does not receive revenue. For example, disclosing a significant



increase in sales and profit by one company can affect market expectations regarding other companies of the same industry.

The most serious consequence of the above-mentioned effects is the difference between the costs and benefits of accounting information disclosure perceived by a company and the actual costs and benefits to society (Scott, 2009). For example, if information disclosed by one company tells something about other companies, society will have benefits, but not the company that discloses. Therefore, the company may lose interest in disclosure of that information. In addition, one company is not interested in disclosure of information that could have negative impacts on its competitive position (such as information on significant research and development projects) despite the potential usefulness of that information in terms of efficiency of capital markets, economic development, and prosperity of the whole society. If information is specific, forward-looking, and quantitative in nature, the possibility of competitive losses will be higher, and the willingness of companies to disclose it will be less.

Considering the combined effects of free-riding and externalities, it can be concluded that the exclusive reliance on free market mechanism would almost certainly result in inadequate quantity and quality of disclosed information, from the viewpoint of society as a whole. Therefore, it is clear that decisions about information to be disclosed, the methods of information preparation, and the frequency of disclosing must not depend solely on the judgments of management. The inclusion of state in the financial reporting process, in terms of subjection of this process to regulation, is the only way to ensure optimal information.

Another disadvantage of free market mechanism is its inability to prevent the *adverse selection* effect of information, which stems from the fact that managers have access to information on all aspects of their companies, but it is not certain that market forces are able to motivate them to disclose all the information. This means that managers could hold useful information, or communicate it only to selected stakeholders. People who possess the information that is not publicly disclosed (insider information) could have substantial personal benefits at the expense of those who do not possess it. The existence of free (unregulated) market also brings the possibility of *moral hazard*. Despite the strong market incentives for information disclosure, managers can try to hide their poor decisions and low profitability by communicating false information or hiding certain information.

Quite different and potentially conflicting interests of the participants in the process of financial reporting are also a serious problem. In general, those who prepare financial statements (i.e. managers) want the reporting system that provides information useful for obtaining capital at the lowest possible price. They also care about the costs of preparing and distributing reports and therefore prefer communicating less information to fewer users. In contrast, users of financial statements require accurate, inexpensive, and reliable information that allow them to make decisions or evaluate past decisions. They need comprehensive and high-quality information available in a simple manner, but also unique information that no one else has. Auditors prefer information that is unbiased and easily verifiable because they are justifiably concerned about possible future criticism by users of financial statements. Finally, from the viewpoint of a society as a whole, it is extremely important that capital market participants have inexpensive information useful for decision-making (Carcello, 2007).

Because of the inability of free market to overcome the conflict of different interest groups successfully, the preparation and publication of financial statements, especially in the case of large companies, must be subject to state regulations. In other words, "the important economic role of financial statements causes society to be concerned about the activities of financial accountants and justifies setting up controls and other regulatory devices to help ensure the availability and usefulness of the information" (Carcello, 2007, p. 1-4). Those devices prevent the irregularities in the process of financial reporting, as managers know that they might be punished if they try to mislead market participants.

The lack of adequate regulation of form and content of financial statements provides incompetent and immoral managers a chance to present financial statements that create a false impression about the financial position and performance of the company, which inevitably leads investors and other users to bad economic decisions. This would undermine the primary purpose of preparing financial statements (Melville, 2011). Numerous cases of fraudulent financial reporting and inability of market mechanism to prevent them prove that regulation of financial reporting is necessary. Defined as "intentional preparation of misleading financial reports" (Needles and Powers, 2007, p. 8), fraudulent financial reporting may be the result of manipulation of accounting documentation and records (such as manipulation of the records of inventories), recording non-existent transactions (such as fictitious sales), or improper use of accounting principles. Regardless of fraudulent financial reporting motives, such as hiding the weaknesses of the company, meeting the expectations of shareholders and financial analysts, easier access to credits, managers' personal benefits (such as additional payment or promotion and avoiding punishment of unsuccessful managers), the consequences could be unforeseeable. Fraudulent (unethical) financial reporting is considered one of the causes of the financial scandals at the beginning of the 21st century that shook the whole world, especially the United States, leading to the bankruptcy of many large and well-known companies (such as Enron and WorldCom) and influencing thousands of people who lost their jobs, investments or pensions. The cases of fraudulent financial reporting and their effects decreased the level of public confidence in the entire financial reporting system and encouraged the reform of corporate governance and financial reporting around the world, in the meaning of tightening the guidelines related to financial statements preparation and auditing. In other words, the financial scandals prompted strengthening the regulation of financial reporting.

If financial reporting regulation (standards) did not exist, the problem of information comparability between companies would probably be particularly significant. In the lack of generally accepted principles and rules for the preparation of financial statements, management of each company would use its own principles and rules created on the basis of personal attitudes and preferences, which would lead to significant variations of form and content of financial statements between companies.

The ultimate consequence of the lack of financial reporting standards would be damaging the integrity of financial statements in the eyes of users (Atrill and McLaney, 2005). The inability of free market mechanism to provide an optimal solution to many problems of financial reporting imposes the need for its regulation, i.e. establishment and strict application of financial reporting standards. Given that, it is quite clear why financial reporting during the 20th century has evolved from a profession that almost exclusively relied on the experience of practitioners into a system replete with a set of standards and an underlying conceptual basis (Storey, 2007).

### **The definition and types of financial reporting standards**

Like natural sciences, in which characteristics of a phenomenon (such as size of a building, room temperature or speed of a car) are quantitatively expressed in accordance with relevant scientifically based rules, the items of financial statements (assets, liabilities, revenues, and expenses) are expressed in appropriate monetary amounts in accordance with applicable financial reporting standards. Financial reporting standards "were almost unknown before World War II" (Baxter, 2004, p. 9), and until the 1970s few academic accountants paid attention to them. Today, the standards play a key role in accountants' day-to-day work and make an indispensable segment of corporate regulation. Financial reporting standards (which are also called accounting standards) can be defined as *a set of principles and rules that companies must follow in preparing their general-purpose financial statements*. They are products of an appropriate procedure (known as *standard setting*), which is conducted by the authoritative institution (known as *the standard setter*). The standards include

instructions on the problems of financial reporting (Alexander and Nobes, 2010), such as a form of financial statements, recognition and measurement of the items of those statements, and disclosures. They can be found in the form of "additions to company law" (Baxter, 2004, p. 16), i.e. as a separate set of documents outside legislation but required (imposed) by legislation, or as a part of the laws themselves.

In the accounting literature, financial reporting standards are often referred to as *generally accepted accounting principles* (GAAP). The term "general acceptance", which originates from the United States, originally denoted a consensus by a relatively small population of accountants on the acceptability of certain accounting practices. However, due to the increasing complexity of practices and increasing demand for state regulation of financial reporting, the meaning of the term has evolved. Today, the term "general acceptance" means acceptance for authoritative (regulatory) body. The principles that lack authoritative support are considered inadequate (Carcello, 2007). Given that, it can be concluded that financial reporting standards are "the authoritative conventions, rules and guidelines used to measure and report resources, obligations, income and expenses of business entities" (Tokar, 2005, pp. 47-48). Those conventions, rules, and guidelines evolve in accordance with changes in the information needs of the users of financial statements as well as achievements of accounting theorists.

Financial reporting standards typically consist of three segments (Baxter, 2004):

1. a description of the problem to be solved,
2. a reasoned presentation of possible ways to solve the described problem, with possible reference to accounting fundamentals; and
3. the recommended solution.

Based on the nature of the problem that standards try to resolve, it is possible to identify four types of standards (Baxter, 2004). The standard of the first type requires accountants "to tell what they do", i.e. to explain the applied accounting policies and assumptions in order to help users to understand the methods of determining the amounts presented in financial statements. The second type of standards is aimed at defining the form of financial statements in terms of order of the items and level of details. The third type of standards deals with specific categories of disclosures in financial statements (such as disclosures on financial instruments and segments). Specifying the types of information to be disclosed, these standards should make the company more transparent to users of financial statements and, therefore, improve the information base for making investment and credit decisions. The standards of the fourth type establish the rules and principles for recognition and measurement of the elements of financial statements (assets, liabilities, revenues, and expenses). These standards, among other things, deal with the fixed assets depreciation methods, calculating the cost of inventories sold or consumed and the value of inventories at the end of a year, calculating the effects of changes in exchange rates, and the recognition and measurement of intangible assets and provisions. The standards of this type are generally subject of serious attention and debate, because they affect reported performance and financial position.

Financial reporting standards impose limits to the discretion of financial statement preparers (Alexander *et al.*, 2007), and thus increase comparability of financial statements between companies by (a) establishing uniform accounting procedures, if possible, and (b) limiting the number of available options for accounting procedures, if the establishment of uniform procedures is not possible. The ultimate purpose of the standards, therefore, is to ensure "different entities apply similar accounting treatments to similar transactions" (Arnold *et al.*, 1994, p. 67). The extent to which standards mainly this purpose primarily depends on two factors (Evans, 2003):

1. underlying accounting theory; and
2. authority of standard-setter.

Accounting theory is like a compass – it directs the process of setting standards. Without theoretical foundation, i.e. adequate and comprehensive *conceptual framework of financial reporting*, development of financial reporting standards would rely only on opinions or political power, and probable consequences would be inconsistencies of standards or lack of support for them. As "a set of agreed fundamental principles which underpin financial accounting" (Melville, 2011, p. 17), a conceptual framework provides a sound theoretical basis for the development of standards.

Financial reporting standards will influence practice only if they have appropriate, authoritative support. In other words, the standard-setting system is not sufficient, and there must be a mechanism for ensuring the strict implementation of established standards. The entire infrastructure for the adoption and enforcement of financial reporting standards should (a) provide a strict interpretation and application of standards and successfully respond to the emerging practical problems, and (b) contribute to the continuous improvement of the financial reporting model and its relevance to users while taking into account costs and benefits (PricewaterhouseCoopers, 2003).

### **Approaches to the establishment of financial reporting standards**

The responsibility for establishing financial reporting standards belongs to the state. However, it may, in part or in full, delegate this responsibility to private sector organization. Today, standard setting process usually involves a combination of private and public (state) sector. The private sector includes accounting profession and other groups involved in the process of financial reporting as users or preparers of financial statements, while the public sector includes bodies responsible for creating corporate law, tax authorities and securities commissions. In recent years, an increasing number of countries practically transferred standard-setting function to a private international organization – International Accounting Standards Board (IASB), which is justified by the growing demand for a single set of global financial reporting standards.

In order to fulfill its role, financial reporting standards have to meet the following criteria (Scott, 2009):

1. usefulness for decision-making process,
2. contribution to reducing information asymmetry,
3. economic acceptability; and
4. political acceptability.

Any new or amended (revised) standard has to improve the quality of financial statements and make them more useful for making investment and credit decisions than the current standards. However, in many cases, it is difficult to estimate the usefulness of standards in advance, i.e. prior to their implementation.

By increasing the quantity and quality of disclosed information, financial reporting standards should contribute to reducing the volume of insider information and thus the information asymmetry in capital markets. Reduction of information asymmetry improves the functioning of capital markets, reduces investment risk, and increases the liquidity of securities, which is beneficial for the whole society.

If the costs of new standards, from the viewpoint of a society as a whole, exceed the benefits arising from better decisions of capital market participants, adoption of those standards would not be economically justified. With respect to that, it is crucial for a standard-setter to assess the economic consequences of any new standard before its adoption.

Justification of new standards from the theoretical and economic aspects may not be sufficient for their success, because standard setting is, largely, a political process. A standard-setter has to reach

consensus of all interest groups, which should be strong enough to ensure compliance with new standards, even by those who disagree with them. The establishment of financial reporting standards can be based on one of two approaches, arising from the two theories on the establishment of regulation in general. The first is the public interest theory, and the second is the interest group theory.

*The public interest theory* is based on the general assumption that the purpose of regulation is to maximize social welfare. Accordingly, financial reporting standards are the result of the need for eliminating the shortcomings of free market mechanism. That need should be met by standard-setter as the central authority. However, although this theory indicates the perfect way for the establishment of financial reporting standards, it has shortcomings related to its implementation. With respect to the real functioning of standard-setters, the public interest theory could be described as "superficial and perhaps naïve" (Scott, 2009, p. 484).

One of the problems in the application of this theory is the difficulties in determining the optimal degree of financial reporting regulation. From the viewpoint of a society, the optimal level of regulation is the level at which the ratio between benefits of information availability and total cost of its generation and communication is the most favorable. However, the costs and benefits are virtually immeasurable categories. The second, equally serious problem is the motivation of a standard-setter. With respect to the complex nature of its task, it would be extremely difficult to monitor its activities and force it to operate in the public interest. In order to find out whether a standard-setter works properly or not, it would be necessary to conduct expensive and extensive research. Impossibility of adequate control of a standard-setter would result in danger of moral hazard of the standard-setter itself, in the sense of satisfying its own needs rather than the needs of the society.

*The interest group theory* is based on the general assumption that the establishment of regulation takes place under conditions of many groups with different and sometimes conflicting interests. According to this theory, the setting of financial reporting standards is not only a professional issue, but also a political process in which different interests are intertwined, while all the interest groups interested in the standards have not only the motive, but also the possibility to influence the standard-setter. Therefore, the lobbying activities undertaken by various interest groups are an inevitable part of the process of standard setting. Those activities might be aimed at encouraging, influencing or obstructing the adoption of standards (Jorissen *et al.*, 2006). From the aspect of a society, lobbying can have a positive connotation, if it is aimed at promotion of better solutions to the problems of financial reporting, but also a negative connotation, if it is aimed at prevention of adopting high-quality solutions or promotion of adopting poor solutions exclusively to protect particular interests. In such circumstances, a standard-setter acts as a intermediary between various interest groups. It attempts to find the best possible compromise between particular interests taking care of its own interests at the same time. In essence, according to the theory of interest groups, financial reporting standards are considered a commodity with its supply and demand that belongs to those interested parties who are the most influential in the political struggle for the favor of the standard-setter.

The theory of interest groups "may seem rather cynical" (Scott, 2009, p. 486), but better explains the actual functioning of standard-setters in comparison with the theory of public interests because it recognizes the existence of conflicting interests. One of the main characteristics of the standard setting in many countries (e.g. in the United States) and on the international arena (by the IASB) is involvement of various interest groups. Final adoption of a standard is usually preceded by publication of a draft that is the subject of public debate, and a standard is adopted by voting. Standard-setters are "players in a complex game where affected constituencies choose strategies of lobbying for or against a proposed new standard" (Scott, 2009, p. 486). If the participants in the game (standard setting) is expected to accept the outcome (publication or non-publication of a new standard and, if the standard is published, its requirements), they must believe that the whole process was fair

and that their opinions were respected. Efforts to reduce inevitable conflicts of interest groups should be a part of the process of standard setting, and all phases of that process should be carefully designed.

For a long time, creation of financial reporting standards was almost exclusively nationally oriented. Each country, in accordance with specific needs and characteristics of environment, established an appropriate mechanism for creating the standards and their imposing to companies. National standards are different in general approach to standard setting, in terms of level of detail and rigidity of requirements, and solutions of specific financial reporting problems, such as the composition of an annual report, recognition and measurement of financial statement items, the types of disclosures, and format of financial statements. However, under the influence of business globalization in general, and the globalization of capital markets and development of multinational companies in particular, it became clear that these differences are a significant barrier to international business. The globalization of financial reporting standards, as a process of reducing differences between national sets of standards, became a matter of immense importance. The expected outcome of this process is a single set of financial reporting standards that would be strictly followed worldwide.

### **The role of financial reporting standards in the contemporary economy**

By determining the accounting information that companies publish financial reporting standards have a significant important role in the contemporary economy. The emergence of financial reporting standards improved the quality of published financial statements around the world, bringing a more comprehensive, understandable and consistent information. They facilitate understanding and analyzing of financial statements, because they allow users to rely on common accounting concepts and definitions, and common rules and principles of recognition and measurement of financial statement items. In the lack of standards, investors, creditors, and financial analysts would have to spend much time and resources in order to understand the basis on which financial statements of each company are prepared. Financial reporting standards are also useful for government institutions responsible for economic policy, which can more easily understand the operation of specific industries and conduct a comparative analysis of the companies that belong to them due to improved comparability of financial statements of different companies.

Financial reporting standards, together with auditing standards, are of considerable importance for the professional accountants responsible for preparing and auditing of financial statements. The standards allow them to resist the pressures of their employers or clients to prepare or approve false (fraudulent) financial statements. Accountants can always refer to the standards and refuse any requirement of their employers or clients that is in conflict with the provisions of standards, while management knows in advance that a change of accountants could not make a change in the way of preparation or auditing of financial statements because the new accountants have to follow the same methods. In addition, the standards protect professional accountants against potential allegation for incompetent or fraudulent preparation or auditing of financial statements, which may arise from the users (investors or creditors) who lost their capital (Benston *et al.*, 2006).

Financial reporting standards (accounting standards) are one of key components of the corporate governance framework. Specifically, they are an essential part of informational infrastructure, which is one segment of corporate governance framework, together with market infrastructure and legal and regulatory environment, as illustrated by Figure 1 (Choi and Meek, 2008).

Along with other segments of the informational infrastructure, financial reporting standards should contribute to timely publication of reliable and complete financial statements, which provide indispensable basis for evaluating the effectiveness of corporate governance and operational and financial performance of companies. The quality of standards that the preparers of financial statements follow directly influences the quality of information presented to capital market participants.

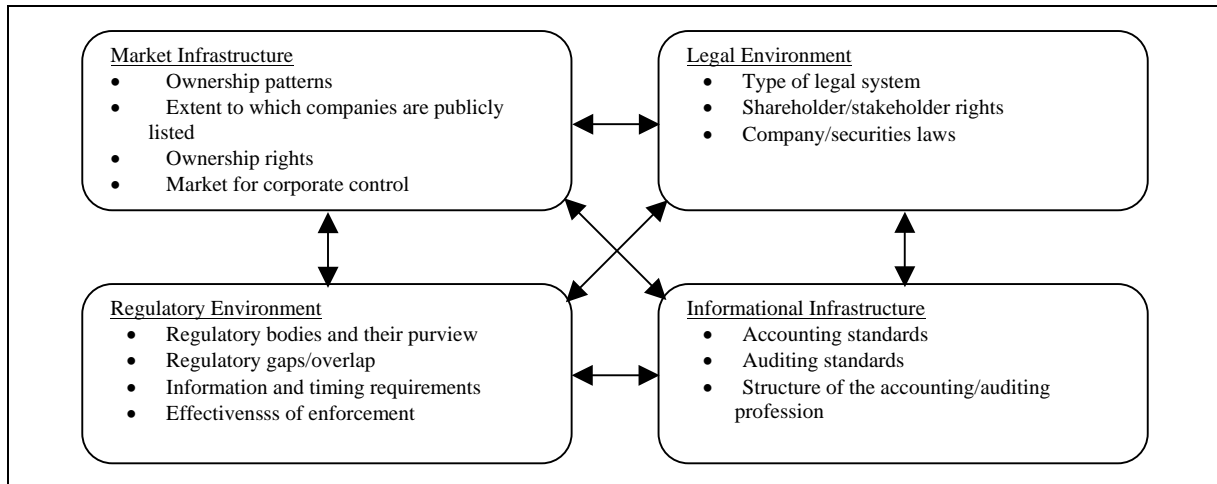

**Figure 1: Corporate Governance Framework**

The relationship between development of financial reporting standards and financial reporting practices is bidirectional. Sometimes, the standards contribute to the development of practices by introducing additional, previously unknown accounting procedures, or imposing disclosure of new, previously unknown information. On the other hand, some accounting procedures are first developed in practice, and then included in standards. In addition, information that some companies voluntarily disclose might become mandatory, if the need for them, from the viewpoint of the whole society, becomes strong enough.

Although financial reporting standards are intended to shape practices, the standards and practices, however, may be inconsistent for three main reasons. First, in some countries, penalties for noncompliance with standards are weak or ineffective. Second, some companies voluntarily disclose more information than required in order to meet the needs of investors and other stakeholders. Third, in some countries, companies are allowed to depart from financial reporting standards if doing so will result in better presentation of performance and financial position (Choi and Meek, 2008).

\* \* \*

Because of the nature of accounting, financial reporting standards cannot offer solutions to every possible accounting problem. The role of standards is to determine the borders in which accountants make judgments, which remain an indispensable part of financial reporting. Standards should be the best expression of existing accounting practices, but also the most valuable theoretical achievements. They should not only describe what accountants already do; they should go a step ahead of accountants imposing new, the best solutions to accounting problems. By promoting best practices, financial reporting standards should contribute to the timely communication of relevant, transparent, and comparable financial information necessary for making decisions by investors, creditors, other stakeholders, and public in general.

The existence of high-quality financial reporting standards does not guarantee high-quality financial reporting. High-quality financial reporting, in fact, is based on four pillars, and comprehensive, consistent, and understandable standards are only one pillar. The rest three pillars are: (a) effective system of corporate governance and internal control, (b) quality auditing practices, and

(c) effective enforcement and oversight to compliance with financial reporting and auditing standards (Goldberg *et al.*, 2006).

### References

- Alexander, D. and C. Nobes (2010). *Financial Accounting: An International Introduction* (4th ed.). Harlow: Pearson Education Limited.
- Alexander, D., A. Britton and A. Jorissen, A. (2007). *International Financial Reporting and Analysis* (3rd ed.). London: Thomson.
- Arnold, J., T. Hope, A. Southworth and L. Kirkham (1994). *Financial Accounting* (2nd ed.). New York: Prentice Hall.
- Atrill, P. and E. McLaney (2005). *Financial Accounting for Decision Maker* (4th ed.). Harlow: Pearson Education Limited.
- Baxter, W. T. (1994). Accounting Standards – Boon or Course? In: *Readings and Notes on Financial Accounting: Issues and Controversies* (4th ed.) (S. A. Zeff. and B. A. Dharan, eds.). New York: McGraw-Hill International Editions, 9-22.
- Benston, G. J., M. Bromwich, R. E. Litan and A. Wagenhofer (2006). *Worldwide Financial Reporting: The Development and Future of Accounting Standards*. Oxford Scholarship Online.
- Carcello, J. V. (2007). Financial Accounting Regulations and Organizations. In: *Accountant's Handbook Volume One: Financial Accounting and General Topics* (11th ed.) (D. R. Carmichael *et al.*, eds.). Hoboken: John Wiley & Sons, Inc.
- Choi, F. D. S. and G. K. Meek (2008). *International Accounting* (6th ed.). New Jersey: Pearson Education International.
- Evans, T. G. (2003). *Accounting Theory: Contemporary Accounting Issues*. Mason: Thomson South-Western.
- Goldberg, S. R., R. Grant, R. and D. Stovall (2006). Are We Closer to Global Accounting Standards? *The Journal of Corporate Accounting & Finance*, 17(6), 35-41.
- Jorissen, A., N. Lybaert and K. Van de Poel (2006). Lobbying Towards a Global Standard Setter – Do National Characteristics Matter? An Analysis of the Comment Letters Written to the IASB. In: *International Accounting: Standards, Regulations, and Financial Reporting* (G. N. Gregoriou and M. Gaber (eds.). Oxford: Elsevier, 1-40.
- Melville, A. (2011). *International Financial Reporting: A Practical Guide* (3rd ed.). Harlow: Pearson Education Limited.
- Needles, B. E. Jr. and M. Powers (2007). *Financial Accounting* (9th ed.). Boston: Houghton Mifflin Company.
- Nobes, C. and R. Parker (2010). *Comparative International Accounting* (11th ed.). Harlow: Pearson Education Limited.
- PricewaterhouseCoopers (2003). *Global GAAP: The Future of Corporate Reporting*. (28 January 2009) <[http://www.complianceweek.com/s/documents/Global\\_GAAP.pdf](http://www.complianceweek.com/s/documents/Global_GAAP.pdf)>.
- PricewaterhouseCoopers (2009). Survey of users' information needs. *World Watch*, 1, 14.
- Scott, W. R. (2009). *Financial Accounting Theory* (5th ed.). Toronto: Pearson Prentice Hall.
- Storey, R. K. (2007). The Framework of Financial Accounting Concepts and Standards. In: *Accountant's Handbook Volume One: Financial Accounting and General Topics* (11th ed.) (D. R. Carmichael *et al.*, eds.). Hoboken: John Wiley & Sons, Inc.
- Tokar, M. (2005). Convergence and the Implementation of a Single Set of Global Standards: The Real-life Challenge. *Accounting in Europe*, 2, 48-68.
- Watts, R. L. and J. L. Zimmerman (1987). The Demand for and Supply of Accounting Theories: The Market for Excuses. In: *Accounting Theory & Policy* (2nd ed.) (R. Bloom and P. T. Elgers, eds.). Orlando: Harcourt Brace Jovanovich, 22-57.



# INTERNATIONAL CONVERGENCE IN PROFESSIONAL ACCOUNTING REGULATION

Ljiljana Dmitrović Šaponja<sup>1</sup>

Sunčica Milutinović<sup>2</sup>

Saša Gravorac<sup>3</sup>

**Abstract:** *Current processes in the world market of goods, services, capital and labor are resulting in the integration of national economies in the multi-dimensional network of social, economic and political relations. These processes impose the need for convergence of business rules, guidelines and principles by introducing uniform frames and uniform standards – in a word, this leads to harmonization of business at the international level. In the overall business internationalization process, it cannot be left out the trend of harmonization of financial reporting such as information - business "language" of communication in the economic relations of various participants in the global market. The initiative for the financial reporting harmonization came from multinational companies, which have achieved their interests by the major international institutions. However, the existence of International Financial Reporting Standards, on the one hand, and US Generally Accepted Accounting Principles, on the other hand, raised the issue of international convergence of these two groups of standards, which began with common agreement on cooperation between the International Accounting Standards Board and Financial Accounting Standards Board. This international convergence in the current professional accounting regulation is the topic of this paper.*

**Keywords:** *IAS/IFRS, US GAAP, IASB, FASB, convergence.*

## Introduction

Current processes on the world market of goods, services, capital and workforce have resulted in interconnection, expansion and globalization of the business environment, which is slowly losing its national barriers. Inclinations are towards integrating national economies in a multi-dimensional network of social, economic and political relations. Such processes impose the need for the harmonization of rules, guidelines and principles of business by introducing uniform frameworks and cohesive standards. In a word, harmonization of business operations is occurring on the international level.

The trend of harmonising the business information “language” used in the communication within economic relations of various participants in the global market cannot be left out from the overall process of business internationalization and globalization of goods, services, capitals and workforce markets. It is the information contained in financial reports, the final output of the financial reporting process that represents today’s “language” of business information, and as such, needs to be harmonized, so that all participants on the global market can easily operate and collaborate.

Harmonization of financial reporting is a time consuming, awaited and demanding process which involves the cooperation of multiple parties: government and its authorities, professional organizations, members of the accounting profession, management, but also the general public, all because of the nature of public interest, which as such is implied when it comes to financial reporting. Uniformity of the business information “language” is achieved by applying instruments of financial reporting, designed using particular standards from the domain of accounting, auditing, quality

---

<sup>1</sup> Faculty of Economics Subotica, University of Novi Sad, ljiljanad@ef.uns.ac.rs

<sup>2</sup> Faculty of Economics Subotica, University of Novi Sad

<sup>3</sup> Faculty of Economics Subotica, University of Novi Sad

## **INTERNATIONAL CONVERGENCE IN PROFESSIONAL ACCOUNTING REGULATION**

---

control, ethics, professional education, electronic collection, processing and distribution of information.

The open market puts emphasis on investors' interest as the main driving force of development. Investors, who make their business decisions based on information found in financial reports, are particularly interested in a unique system of financial reporting, international transparency, clarity and comparability of accounting information, as well as in a true and fair display of the corporate entity's position regarding finance, equity and profitability. This can be achieved through unified rules, principles, guidelines and standards used in evaluating balance sheet items, creating financial reports and publishing data contained in them.

The initiative for the harmonization of financial reporting originated from multinational companies, which have accomplished their interests through international institutions such as the World Bank (WB), United Nations (UN), European Bank for Reconstruction and Development (EBRD), the Organization for Economic Cooperation and Development (OECD), World Trade Organization (WTO) and many others. Support was provided by regulatory bodies, professional organizations, auditing firms, business entities, investors and other stakeholders. The most appropriate solution was to adopt a set of international standards for accounting and auditing.

Worldwide harmonization of financial reporting occurred in stages. Back in 1973, representatives of professional accounting organizations from Australia, France, Japan, Canada, Mexico, the Netherlands, Germany, United Kingdom, Ireland and subsequently the US signed a contract on founding of the IASC (International Accounting Standards Committee). Two years later, the first two international accounting standards were adopted: IAS 1 – Disclosure of Accounting Policies and IAS 2 – Valuation and Presentation of Inventory in the Context on the Historical Cost System. Nine years since the founding of IASC, IFAC (International Federation of Accountants) recognized IACS as a global standard-setting authority.

### **Stage One: From the Norwalk Agreement to the Memorandum of Understanding (2002-2009)**

After the joint meeting in September 2002, IASB (International Accounting Standards Board – IASC was renamed to IASB in 2001) and FASB (Financial Accounting Standards Board) signed the Norwalk Agreement (it was named after the city where the joint meeting of two boards took place – Norwalk, Connecticut, USA) in which both bodies expressed their own commitment to develop a high-quality, compatible accounting standards that should be applicable to both domestic and international financial reporting. At this meeting, FASB and IASB (hereinafter referred to as: boards) promised to devote their best effort to making present standards in financial reporting completely compatible as soon as possible, and to coordinate their future work programs, in order to ensure the maintenance of prospective compatibility. At the meetings held in April and October 2005, the boards have confirmed that the development of a joint set of high-quality global standards remains a strategic priority of both FASB and IASB.

In February 2006, the boards issued a Memorandum of Understanding – MoU (also called the First Roadmap). It concerned cooperation and harmonization of IAS/IFRS and US GAAP (hereafter: standards). The Memorandum encompassed projects on the harmonization of standards for which the boards find that their improvement is most needed in the near future. The boards agreed to develop a plan on carrying out each of the identified projects, principally by developing new standards in order to improve the quality of both standard sets and achieve better convergence between the US GAAP and IAS/IFRS. The memorandum contains short-term projects (some of which have been completed, while some are in their final stages) and long-term projects, of which three stand out as projects of high priority: financial instruments, lease and revenue recognition and, for which the boards still need to conclude on their technical solutions. Tables 1, 2, 3 and 4 show the list of long-term projects

included in the MoU, current status (status on November 16, 2011) of each project, the associated guidelines and the degree of inclusion of each project.

**Table 1. A listing of the longer-term projects in MoU (Work Plan for the Consideration of Incorporating International Financial Reporting Standards into the Financial Reporting System for U.S. Issuers, 2011, p. 4)**

Project	Status	Milestone
<i>Financial instruments</i>	Various for the different project elements.	<p>The financial instruments project includes the following elements: classification and measurement, impairment, hedge accounting, and balance sheet offsetting. Although the Boards continue to have the objective of issuing converged standards, project timing and the phasing of the project has differed for each Board. A summary of each Board’s activities is as follows:</p> <p>The IASB considers each element (listed above) as a separate phase. Accordingly, the Board issued IFRS 9, <i>Financial Instruments</i>, in November 2009, which contained requirements for financial assets. Requirements for financial liabilities were added to IFRS 9 in October 2010. IFRS 9 is not yet effective, but early adoption is permitted. The IASB (together with the FASB) issued a supplementary document, <i>Financial Instruments: Impairment</i>, in January 2011. The comment period closed in April 2011 and redeliberations are on-going. The IASB issued the exposure draft, <i>Hedge Accounting</i>, in December 2010. The comment period closed in March 2011 and redeliberations are on-going.</p> <p>The FASB initially scoped the financial instruments project as two phases—1) classification and measurement, impairment, and hedging and 2) balance sheet offsetting. In May 2010, the Board issued a proposed Accounting Standards Update (“ASU”), <i>Accounting for Financial Instruments and Revisions to the Accounting for Derivative Instruments and Hedging Activities</i>. The comment period ended in September 2010. In January 2011, the FASB (together with the IASB) proposed a common solution for impairment accounting, Supplementary Document—<i>Accounting for Financial Instruments and Revisions to the Accounting for Derivative Instruments and Hedging Activities—Impairment</i>. The comment period ended in April 2011. In February 2011, the FASB issued a Discussion Paper—Invitation to Comment—<i>Selected Issues about Hedge Accounting</i>, to solicit input on the IASB’s exposure draft in order to improve, simplify, and converge the financial reporting requirements for hedging activities. The comment period ended in April 2011. Redeliberations are ongoing for all aspects of this project.</p> <p>The balance sheet offsetting portion of the project has followed a consistent timeline for both Boards. In January 2011, the Boards jointly issued the exposure draft, <i>Balance Sheet Offsetting</i> (titled by the IASB as, <i>Offsetting Financial Assets and Financial Liabilities</i>), which proposed changes to address the differences between IFRS and U.S. GAAP. In June 2011, in the light of feedback received on the exposure draft, the Boards decided to move forward with different offsetting models. The Boards noted that users consistently asked that information be provided to help reconcile differences in the offsetting requirements between IFRS and U.S. GAAP. Therefore, the Boards decided to work on converging disclosure requirements to assist users in comparing financial statements prepared in accordance with IFRSs and US GAAP. Such deliberations are ongoing.</p> <p>Note: Because this project was an active on-going MoU project at the time of our analysis, a comparison of the existing FASB and IASB standards related to this project has been <b>excluded</b> from this paper.</p>

**Table 2. A listing of the longer-term projects in MoU (Work Plan for the Consideration of Incorporating International Financial Reporting Standards into the Financial Reporting System for U.S. Issuers, 2011, p. 5)**

Project	Status	Milestone
<i>Revenue recognition</i>	Re-exposure of proposals.	<p>The Boards published a joint discussion paper, <i>Preliminary Views on Revenue Recognition in Contracts with Customers</i>, in December 2008 and a joint exposure draft, <i>Revenue from Contracts with Customers</i>, in June 2010. In June 2011, the Boards concluded that, although their due process requirements made it clear that re-exposure was not required, they would re-expose the proposals because of the special nature of revenue.</p> <p>Note: Because this project was an active on-going MoU project at the time of our analysis, a comparison of the existing FASB and IASB standards related to this project has been <b>excluded</b> from this paper.</p>
<i>Leases</i>	Redeliberation of exposure draft; re-exposure of proposals.	<p>The Boards published a joint discussion paper, <i>Leases: Preliminary Views</i>, in March 2009 and a joint exposure draft, <i>Leases</i>, in August 2010. In July 2011, the Boards agreed to re-expose the revised proposals because the decisions taken to date were sufficiently different from those published in the exposure draft to warrant re-exposure. The Boards expect to continue re-deliberations through 2011.</p> <p>Note: Because this project was an active on-going MoU project at the time of our analysis, a comparison of the existing FASB and IASB standards related to this project has been <b>excluded</b> from this paper.</p>
<i>Consolidations</i>	Ongoing (re: investment companies).	<p>The IASB issued IFRS 10, <i>Consolidated Financial Statements</i>, and IFRS 12, <i>Disclosure of Interests in Other Entities</i>, in May 2011. IFRS 12 includes disclosure requirements about off balance sheet risks. The issuance of IFRS 10 resulted in substantial convergence of IFRS with U.S. GAAP on consolidation of structured investment vehicles and other special purpose entities as well as related disclosures, although differences between IFRS 10 and ASC Topic 810, <i>Consolidation</i>, remain. The Boards continue to jointly consider issues related to the consolidation of investment companies and plan to issue converged standards in the future.</p> <p>Note: Because this project was an active on-going MoU project at the time of our analysis, a comparison of the existing FASB and IASB standards related to this project has been <b>excluded</b> from this paper.</p>
<i>Fair value measurement</i>	Completed.	<p>The FASB issued FASB Statement No. 157, <i>Fair Value Measurements</i>, (codified in ASC Topic 820, <i>Fair Value Measurements and Disclosures</i>) in 2006. The FASB has issued several ASUs in 2009-2011 (including the most recent amendment: ASU No. 2011-04, <i>Amendments to Achieve Common Fair Value Measurement and Disclosure Requirements in U.S. GAAP and IFRSs</i>, that was released to coincide with the IASB's issuance of IFRS 13, <i>Fair Value Measurement</i>). The IASB issued IFRS 13 in May 2011. The recent guidance issued by the Boards is converged.</p> <p>Note: Because this project was an active on-going MoU project at the time of our analysis, a comparison of the existing FASB and IASB standards related to this project has been <b>excluded</b> from this paper.</p>

**Table 3. A listing of the longer-term projects in MoU (Work Plan for the Consideration of Incorporating International Financial Reporting Standards into the Financial Reporting System for U.S. Issuers, 2011, p. 6)**

Project	Status	Milestone
<i>Financial statement presentation</i>	Reassessed as a lower priority project.	<p>The Boards published a joint discussion paper, <i>Preliminary Views on Financial Statement Presentation</i>, in October 2008. After considering the 220 comment letters and the results of field tests, the FASB and IASB staff published staff drafts reflecting the Boards' tentative decisions to date. The Boards used that draft as the basis for additional outreach.</p> <p>The outreach indicated that some participants had concerns about aspects of the proposals but supported others. The Boards concluded that significant additional work would be required to develop a viable exposure draft. In the light of other priorities, the Boards decided to consider returning to the project once the other MoU projects had been completed.</p> <p>The Boards did, however, decide to align how other comprehensive income is reported. The Boards published an exposure draft, <i>Statement of Comprehensive Income</i>, in May 2010 and issued amendments in June 2011.</p> <p>Note: This project remains on the FASB/IASB technical plan; however, the project was reassessed as a lower priority project. The standards related to this project have been <b>excluded</b> from this paper.</p>
<i>Derecognition</i>	Project scope reassessed.	<p>Through separate standard setting efforts completed by the end of 2010, the Boards reduced differences between IFRS and U.S. GAAP relating to the derecognition of financial assets and liabilities and substantially aligned the related disclosure requirements.</p> <p>Note: Because this project was an active on-going MoU project at the time of our analysis, a comparison of the existing FASB and IASB standards related to this project has been <b>excluded</b> from this paper.</p>
<i>Post-employment benefits</i>	Completed.	<p>In April 2010, the IASB published an exposure draft, <i>Defined Benefit Plans</i>. The IASB finalized amendments to IAS 19, <i>Employee Benefits</i>, in June 2011.</p> <p>Note: The changes resulting from the amendments to IAS 19 have been incorporated into our analysis and included in this paper (see sections III.N. <i>Exit or Disposal Cost Obligations</i> and III.S. <i>Compensation – Excluding Share-based Payments</i>).</p>
<i>Business combinations</i>	Completed.	<p>The Boards issued joint requirements for business combination accounting and noncontrolling interests in 2008—IFRS 3, <i>Business Combinations</i>, and amended IAS 27, <i>Consolidated and Separate Financial Statements</i>, and FASB Statement No. 141 (revised), <i>Business Combinations</i>, codified in ASC Topic 805.</p> <p>Note: Because this project was finalized before our comparison analysis was performed, a comparison of the FASB and IASB standards related to this project has been included in this paper (see section III.X. <i>Business Combinations</i>).</p>



**INTERNATIONAL CONVERGENCE IN PROFESSIONAL ACCOUNTING REGULATION**

**Table 4. A listing of the longer-term projects in MoU (Source: Work Plan for the Consideration of Incorporating International Financial Reporting Standards into the Financial Reporting System for U.S. Issuers, 2011, p. 7)**

<b>Project</b>	<b>Status</b>	<b>Milestone</b>
<i>Financial instruments with characteristics of equity</i>	Reassessed as a lower priority project.	<p>In February 2008, the IASB published a discussion paper, <i>Financial Instruments with Characteristics of Equity</i>, to solicit input on a previously exposed FASB document. The IASB and FASB used the responses to help them develop a working draft of a proposal to replace existing guidance on these types of financial instruments, which they used to undertake focused outreach. In the light of comments received, the Boards decided to focus on other projects and not to publish an exposure draft in the near term as originally planned. The Boards will consider returning to this project at a later date.</p> <p>Note: This project remains on the FASB/IASB technical plan; however, the project was reassessed as a lower priority project. The standards related to this project have been <b>excluded</b> from this paper.</p>
<i>Intangible assets</i>	Reassessed as a lower priority project.	<p>The IASB considered an agenda proposal to add a project on intangible assets in December 2007. The IASB decided not to proceed with the project but will reconsider it when it sets its new agenda. The FASB has not added a project to its active agenda.</p> <p>Note: Because this project was not an active on-going MoU project at the time of our analysis, a comparison of the existing FASB and IASB standards related to this project has been included in this paper (see section III.J. <i>Intangibles</i>).</p>
<i>Insurance</i>	Redeliberation of exposure draft; re-exposure of proposals.	<p>The IASB published an exposure draft, <i>Insurance Contracts</i>, on July 30, 2010. The FASB published a discussion document of its own, which included alternative views, in September 2010. Most recently, the Boards have been considering together the feedback received on the IASB’s exposure draft and the FASB discussion paper. The Boards are conducting targeted outreach, based on the decisions made, to a broad range of global constituents and will continue to do so on future decisions. The IASB is working to issue a review draft or revised ED by in the 1<sup>st</sup> half of 2012. The FASB will consider the feedback received on its exposure draft with a view to finalizing a standard in 2012. The Boards will then consider any differences that may have arisen and how best to address them.</p> <p>Note: Because this project was an active on-going joint project at the time of our analysis, a comparison of the existing FASB and IASB standards related to this project has been <b>excluded</b> from this paper.</p>

This memorandum has set certain priorities within the FASB and IASB's joint program, in the form of specific stages that were to be realized until 2008. The Memorandum was based on the following three principles (Memorandum of Understanding between FASB and IASB, 2006): (1) Convergence of standards in accounting can be achieved best through period of time by means of developing high-quality common standards; (2) Attempt to eliminate differences between two standards that require major improvements does not represent a best use for FASB and IASB’s resources, so it is necessary to develop a new common standard that will provide investors with financial information; (3) The need to satisfy investors’ information needs means that boards should

seek convergence in replacing the standards with newly developed common standards, all for the purpose of achieving advancement.

The Second Roadmap was agreed upon in November 2008. The goal of this plan was to enable companies to submit their annual financial reports, prepared in accordance with the IAS/IFRS and for these reports to be accepted by the US Securities and Exchange Commission (hereinafter: SEC). This followed the announcement in 2007, which had stated that SEC no longer required that submitted financial statements in compliance with IAS/IFRS should also be in compliance with US GAAP.

Based the Second Roadmap, a small group of companies began to prepare their financial reports in accordance with the IAS/IFRS, from December 15 2009 onwards. Companies that met the requirements were among the largest in that branch (measured by market capacity), and the financial reporting of these companies was based on IAS/IFRS. This announcement was made in January 2009, in a report published by the SEC. According to this announcement, a two-year period of compulsory double-entry accounting begins in 2012 for most companies, whereas in 2014, the financial reporting will be required to be based solely on IAS/IFRS. This decision by SEC reflects the expansion of application of IAS/IFRS as a widespread and high-quality language of financial reporting. The global financial crisis has served as an additional trigger of the convergence process, especially over the past year.

Among the numerous long-term projects included in the Second Roadmap, the following six are of particular importance (Sweetman, 2009, p. 3):

- Fair value measurement – the objective is to clarify the definition of fair value and to establish a single source of guidance for fair value measurement.
- Post-employment benefits – IASB and FASB intend to move to a common standard on this topic, but there are currently significant differences between their respective positions.
- Revenue recognition – the objective is to develop a single model for the recognition of revenue which can be applied across industries and geographical regions. This would improve comparability and understanding of financial reporting information.
- Leases – a new standard may result in operating leases being regarded as an asset for the right to use an item, while also recognizing the liability to make rental payments. A standard on this topic is not expected until 2011.
- Earnings per share – this has involved both IASB and FASB reviewing proposed amendments to the calculation of diluted earnings per share.
- Conceptual framework – to date, this has focused on the objectives of financial reporting and the qualitative characteristics of financial reporting information.

In the meantime, the boards have completed their engagements on joint standard-setting projects which concern: financial instruments, revenue recognition, leases, gross-profit recognition fair-value measurement (completed during 2011), measurement of derivative and financial instruments with the characteristics of equity, financial statements presentation, presentation of discontinued operations, consolidation of entities, derecognition (completed during 2010) and insurance contracts. Some of these projects are parts of the Memorandum of Understanding (MoU), which defines the scope of the program on joint engagement of boards regarding the improvement and promotion of convergence between their accounting standards (see Table 5 and 6).

**INTERNATIONAL CONVERGENCE IN PROFESSIONAL ACCOUNTING REGULATION**

**Table 5. IASB Work Plan – projected targets as at 14 June 2012: Agenda Consultation, Financial Crisis Related Projects, and Memorandum of Understanding Projects**

(<http://www.ifrs.org/Current+Projects/IASB+Projects/IASB+Work+Plan.htm>, 18/06/2012)

Next major project milestone						
Agenda consultation	2012 Q2	2012 Q3	2012 Q4	2013 Q1	MoU	Joint
Three-yearly public consultation	Feedback Statement	Development of strategy				
Next major project milestone						
Financial Crisis related projects	2012 Q2	2012 Q3	2012 Q4	2013 Q1	MoU	Joint
IFRS 9: Financial instruments (replacement of IAS 39)						
Classification and measurement (review)			Target ED		✓	✓
Impairment			Re-exposure		✓	✓
Hedge accounting						
General hedge accounting	Review draft	Target IFRS			✓	
Macro hedge accounting		Target DP			✓	
Next major project milestone						
Memorandum of Understanding projects	2012 Q2	2012 Q3	2012 Q4	2013 Q1	MoU	Joint
Leases			Re-exposure		✓	✓
Revenue recognition	Consider comments received				✓	✓



**Table 6. IASB Work Plan – projected targets as at 14 June 2012: Other Projects, and Post-implementation Reviews**

(<http://www.ifrs.org/Current+Projects/IASB+Projects/IASB+Work+Plan.htm>, 18/06/2012)

Next major project milestone						
Other Projects	2012 Q2	2012 Q3	2012 Q4	2013 Q1	MoU	Joint
Insurance contracts		Review draft or revised ED				✓
IAS 8 Effective date and transition methods		Target ED				
Annual improvements 2010-2012				Target completion		
Annual improvements 2011-2013		Target ED				
Consolidation– Investment entities		Target IFRS				✓
Transition Guidance (Proposed amendments to IFRS 10)	Target amendment					
Next major project milestone						
Post-implementation reviews	2012 Q2	2012 Q3	2012 Q4	2013 Q1	MoU	Joint
IFRS 8 Operating Segments	Request for Information					
IFRS 3 Business Combinations		Initiate review				

### Stage Two: From FASB Project Plans to the AICPA Financial Reporting Framework for Small and Medium-sized Entities (2010-2013)

FASB periodically generates project plans, in order to inform stakeholders on their activities concerning the convergence of standards. Project plans encompass all of the projects and include estimated dates of publication during 2012 and the first quarter of 2013 (discussions – marked with “D”, exposure drafts – marked with “E”, final versions of the revised accounting standards or the final sections of the conceptual framework – marked with “F”). The most current Technical Plan and projects revised by FASB are shown in Table 7.

**Table 7. Current Technical Plan and Project Updates by FASB**

(<http://www.fasb.org/jsp/FASB/Page/SectionPage&cid=1218220137074>, 18/06/2012)

Current Technical Plan	2012			2013
	Q2	Q3	Q4	Q1
<b>ACTIVE JOINT FASB/IASB PROJECTS:</b>				
Standards Projects:				
Investment Companies ( <i>Updated May 23, 2012</i> )			F	
Accounting for Financial Instruments ( <i>Updated May 29, 2012</i> )				
Impairment ( <i>Updated May 29, 2012</i> )			E	
Classification and Measurement ( <i>Updated May 29, 2012</i> )			E	
Hedging ( <i>Updated May 29, 2012</i> )				
Insurance Contracts ( <i>Updated May 31, 2012</i> )			E	
Leases ( <i>Updated June 7, 2012</i> )			E	
Revenue Recognition ( <i>Updated May 29, 2012</i> )				F
Consolidation: Policy and Procedures ( <i>Updated May 7, 2012</i> )				
<b>FASB PROJECTS:</b>	<b>Q2</b>	<b>Q3</b>	<b>Q4</b>	<b>Q1</b>
Accounting for Financial Instruments: Liquidity and Interest Rate Disclosures ( <i>Updated May 25, 2012</i> )	E			
Liquidation Basis of Accounting and Going Concern (formerly Disclosures about Risks and Uncertainties) ( <i>Updated May 18, 2012</i> )				
Liquidation Basis of Accounting (phase 1)	E			
Going Concern (phase 2)			E	
Nonpublic Entity Fair Value Measurement Disclosures ( <i>Updated May 1, 2012</i> )	E			
Technical Corrections and Improvements ( <i>Updated June 7, 2012</i> )		F		
Continuing Care Retirement Communities		F		
Impairment of Indefinite-Lived Intangible Assets ( <i>Updated June 11, 2012</i> )		F		
Presentation of Comprehensive Income: Reclassifications Out of Accumulated Other Comprehensive Income ( <i>Updated January 5, 2012</i> )		E		
Transfers and Servicing: Repurchase Agreements and Similar Transactions ( <i>Updated March 28, 2012</i> )		E		
Definition of a Nonpublic Entity ( <i>Updated June 12, 2012</i> )		D		
Disclosure Framework ( <i>Updated May 14, 2012</i> )		D		
Investment Property Entities ( <i>Updated May 31, 2012</i> )			F	
Disclosure of Certain Loss Contingencies ( <i>Updated October 24, 2011</i> )				
Not-for-Profit Financial Reporting: Financial Statements ( <i>Updated June 11, 2012</i> )				
<b>FASB RESEARCH PROJECTS:</b>	<b>Q2</b>	<b>Q3</b>	<b>Q4</b>	<b>Q1</b>
Private Company Decision-Making Framework ( <i>Updated May 17, 2012</i> )		D		
Application of Asset- or Entity-Based Guidance to Nonfinancial Assets Held in an Entity ( <i>Updated April 13, 2012</i> )				
Not-for-Profit Financial Reporting: Other Financial Communications ( <i>Updated April 20, 2012</i> )				

Having produced a plan to stop the convergence of standards, SEC ([US](#) Securities and Exchange Commission) definitely renounced their requests for convergence and calls for annotations regarding the application of IAS/IFRS for business entities registered in the US. However, 2008 brought a reversal in the domain of collaboration and convergence of standards. SEC proposed a plan for the adoption of IAS/IFRS for business entities registered in the United States. IOSCO (International Organization of Securities Commissions) published a statement encouraging business entities to explicitly declare whether they fully comply with IAS/IFRS. In the meantime, IASB and FASB resumed their further cooperation and hastened efforts on the completion of joint projects, with the anticipation that the IAS/IFRS will be adopted in the US by 2014.

In February 2010, SEC published the Work Plan for the Consideration of Incorporating International Financial Reporting Standards into the Financial Reporting System for U.S. Issuers (Work Plan for the Consideration of Incorporating International Financial Reporting Standards into the Financial Reporting System for U.S. Issuers, 2011). The Work Plan was ratified so that the Commission, based on reviews of specific areas and factors, may come to know whether the present system of financial reporting in the US will be converted into a system that functions on the basis of IAS/IFRS, when, and how this will occur.

Only some of the differences that can be detected by comparing texts of IAS/IFRS and US GAAP will be presented in this article. The scope of this article does not permit the exhibition of all differences. Hence, this article will focus only on most important ones (for a complete text on the differences between the IAS/IFRS and US GAAP, see: Work Plan for the Consideration of Incorporating International Financial Reporting Standards into the Financial Reporting System for U.S. Issuers, 2011, p. 11-50). One of the general differences between these two groups of standards is that US GAAP contains more detailed requirements in comparison to the IAS/IFRS. In some cases, IAS/IFRS do not incorporate appropriate guidelines, while in other, incorporate general guidelines or high-level guidelines which are not straightforwardly comparable to US GAAP requirements. In other cases, IAS/IFRS contain topic-related guidelines that do not correspond directly to any suitable guidelines within US GAAP.

The observed differences do not necessarily suggest that they have a direct and consistent correlation with the quality of IAS/IFRS. Furthermore, it does not mean that the observed differences should be necessarily eliminated prior to any consideration by the SEC in relation to the inclusion of IAS/IFRS into the U.S. financial reporting system. The overview of differences between the two standard sets is presented in Table 8.

**Table 8. Summary of differences between IAS/IFRS and US GAAP (Sweetman, 2009, p. 6)**

Topic	IAS/IFRS	US GAAP
Inventory valuation	LIFO not permitted	LIFO permitted
Development costs	Capitalize when criteria met	Expensed
Non-current assets	Historical cost or valuation	Historical cost
Extraordinary items	Prohibited	Permitted under specific circumstances
Joint ventures	Equity accounting or proportional consolidation	Equity accounting
Fair value	The value at which an asset or liability can be exchanged in an arm's length transaction	Exit or disposal value

## **INTERNATIONAL CONVERGENCE IN PROFESSIONAL ACCOUNTING REGULATION**

---

The fundamental differences between the two standard sets originate principally from these two facts (according to: Work Plan for the Consideration of Incorporating International Financial Reporting Standards into the Financial Reporting System for U.S. Issuers, 2011, p. 10-11):

1. IAS/IFRS encompass wider rules and principles concerning transactions within the industry, with specific guidelines and exceptions from specific guidelines. It has already been stated that these standards do not incorporate general guidelines that correspond to the detailed demands of US GAAP.
2. There are fundamental differences between the IASB's Framework for the Preparation and Presentation of Financial Statements ("Conceptual Framework") and the FASB's Statements of Financial Accounting Concepts ("Concepts Statements"). These frameworks differ in terms of basic concepts and permissions to apply these concepts. Fundamental differences that presently exist between these conceptual frameworks appear in the following fields:
  - a. Degree of authority – In case of the application of IAS/IFRS, the Conceptual Framework represents an authoritative guide, and concepts are applied when there is no standard or interpretation that specifically applies to a transaction, event or condition. In case of the application of US GAAP, Concepts Statements is not included into the Accounting Standards Codification, and therefore does not represent an authoritative guide of FASB. The Difference in the degree of authority can adversely influence the comparability of accounting transactions recorded in accordance with the IAS/IFRS and US GAAP, even if the applied concepts within IASB's and FASB's frameworks are in correspondence.
  - b. Defining and recognizing assets and liabilities – The Concept Statements defines an asset or a liability in the sense of a likely future event (i.e. economic benefit for the asset or economic cost for a liability), whereas likely is defined from the perspective of general use and is applicable to anything that can be reasonably expected or assumed, based on available evidence. IAS/IFRS do not involve the concept of likelihood in their definition of assets and liabilities, but consider the possibility of generation during recognition (i.e. recognize the asset when it is certain that the future economic benefits would come to the business entity, and a liability is recognized when it is certain that an outflow will result from settlement of current liabilities), although they never define the term *probable*. IAS/IFRS have an additional criterion for recognition, which requires that entities be capable of measuring a cost or a value reliably before the recognition.

In May 2012, American Institute of Certified Public Accountants (AICPA) announced that it was planning to publish the Financial Reporting Framework for Small- and Medium-sized Entities (so-called FRF for SMEs), which are not required to submit their financial statements in accordance with US GAAP. The framework was designed to be simpler and less extensive than US GAAP, which should enable entities to save money on the preparation of financial statements, and at the same time, provide banks and other users of financial statements with information they need.

The framework will be non-authoritative, which means that the AICPA will not be empowered to demand from any entity to use it. The framework will be independent; it will be suitable for use in by entities from all industries and will rely on the combination accrual income tax methods and other traditional methods of accounting. Furthermore, the framework will incorporate many income tax methods so that owners (as well as managers of these entities) can essentially have one set of books for preparing their financial statements to give to their banks and file their tax returns.

The goal of this framework is best illustrated by the following statement from Chuck Landes, vice president of AICPA for Professional Standards and Services (Tysiac, 2012). “Users for SME financial statements are primarily lenders, banks that have made loans to the small business and want to understand the company’s financial position, what they own, what they owe,” said Landes. “They also want to understand their operations, and how the company makes money. And they also want to understand what kind of cash flow is available from this company to make certain that they can repay any amounts that are lent to the company. This framework will provide the information they need in a more cost-effective manner by eliminating accounting requirements that are not relevant to users.”

## Conclusion

International convergence in the domain of professional accounting regulations is a process which was officially initiated ten years ago, for the purpose of developing high-quality and compatible standards of accounting that could be used in international financial reporting. Better convergence between two currently most prevalent standards – IAS/IFRS and US GAAP can be best achieved through the development of new, common standards, which are to replace present standards, and in such way improve the quality and compatibility of these standard sets.

Effort, engagement and activities of the most prominent professional bodies (IASB, FASB, SEC, AICPA) that were put in the international convergence confirm that the use of IAS/IFRS is slowly expanding outside the borders of the European Union, which is the native area of its origin and application. In such way, this standard set justifies its status as a widespread, high-quality language of international financial reporting. The aforementioned globally prominent contributors envisaged the international convergence as a process which takes in the account the following:

- *Investors and other creditors*: from the point of satisfying information needs, new, common standards should enable these most important stakeholders to easily access information on the financial position, profit and assets of the entity, which is the subject of financial statements, more easily.
- *Business entities*: from the point of reaching uniform, simplified and cost-efficient accounting standards that will serve as a basis for generating only one set of financial statements that is to satisfy information needs of all stakeholders.
- *Stakeholders*: those who regularly receive reports on stages completed to this point, accomplished short-term and long-term plans, and further steps in the international convergence of accounting.

What is forthcoming in the domain of international convergence is publication of the *Financial Reporting Framework for Small- and Medium-sized Entities* u 2013 by AICPA. It is also expected that early 2014 will see the launch of the long-announced and awaited process of financial reporting in the USA based solely on IAS/IFRS. The global financial crisis will undoubtedly aggravate the implementation of these plans, and make a particular impact on the course of the international convergence in international accounting regulations.

## References

- Annual Improvements to IFRSs 2010–2012 Cycle (2012). London: IFRS.
- Commission Statement in Support of Convergence and Global Accounting Standards (“2010 Statement”), SEC Release No. 33-9109 (2010). New York: U.S. Securities and Exchange Commission.
- Financial Reporting Framework for Small- and Medium-sized Entities (2012). New York: AICPA.

## **INTERNATIONAL CONVERGENCE IN PROFESSIONAL ACCOUNTING REGULATION**

---

Memorandum of Understanding between the FASB and the IASB (2006). London: IFRS.

Roadmap for the Potential Use of Financial Statements Prepared in Accordance with International Financial Reporting Standards by U.S. Issuers, SEC Release No. 33-8982 (2008). New York: U.S. Securities and Exchange Commission.

Sweetman, Tony (2009). Convergence Between IFRS and US GAAP. *Student Accountant* – the magazine for ACCA Qualification and Foundations in Accountancy students, 11/2009. London: ACCA.

Tysiac, Ken (2012). AICPA reporting framework for SMEs expected early in 2013. *Journal of Accountancy*, June 7. New York: AICPA.

Work Plan for the Consideration of Incorporating International Financial Reporting Standards into the Financial Reporting System for U.S. Issuers, Staff Paper (2011). New York: U.S. Securities and Exchange Commission.

<http://www.accaglobal.com>

<http://www.fasb.org>

<http://www.iasplus.com>

<http://www.ifrs.org>

<http://www.journalofaccountancy.com>

# FRAUDULENT FINANCIAL REPORTING – ESSENCE, MOTIVES AND METHODS

**Dragomir Dimitrijević<sup>1</sup>**

**Abstract:** *Reliability and transparency of financial reporting, resulting in truthful enterprise financial results presentation, is one of the most essential financial system reliability and stability determinants. High level of trust in the quality of information offered by financial statements provides investors with confidence encouraging them to invest. It also accelerates commodity and financial flows and raises the efficiency of economy and capital market. Numerous financial frauds (Enron, WorldCom) and current financial crisis cause great deal of distrust in financial reporting system as well as in auditing and accounting profession which is often accused for frauds emergence and losing of trust into financial information reliability by numerous beneficiaries and economic decision-makers. To restore lost credibility is possible only if professional accountants and other participants in financial reporting processes comply with basic accounting principles and accounting standards prescribed by the law. This paper aims to provide analysis of financial statements frauds influences on financial information reliability, possible motives for frauds and the level of accounting, auditing and especially enterprise management profession responsibility.*

**Keywords:** *frauds, financial statements, financial information, motives, level of responsibility*

## **Introduction**

Primary aim of financial statements is to provide their users with understandable, relevant, reliable and comparable financial information on performing business of business entities. Unreliable and false financial statements, which managers at companies, banks, insurance companies and other financial institutions submit to all external users, can be marked as one of the main reasons for frequent frauds. Contemporary trends and aspects such as illegal activities of certain companies (Enron, WorldCom), bankruptcy of large financial systems caused by embuzzlements, have caused lost of trust in information which are offered in financial statements. Large financial frauds at the end of previous and at the beginning of this century have put in focus the problem of quality of financial reporting. The fact that the largest number of frauds were followed by manipulations in financial statements has shown the importance of quality maintenance of financial reporting and the necessity of better legal regulation in the field of financial reporting. In order to provide conditions for financial statements to offer to all the users real and useful information, it is necessary for the accounting profession, legislation and state, by common efforts, to set the rules which should be applied, as well as the mechanisms of control of obeying the rules. The theme of this paper is to look closer into the problem of composing false financial statements, motives and techniques for creation of fraudulent financial reporting.

## **Fraudulent financial reporting -principle and forms**

Market for stocks and other securities is a critical component of every financial market of a country, especially of the developing countries. Efficiency, liquidity and elasticity of stock markets depend on capability of investors to estimate correctly the performances of many companies. Precisely financial statements of companies have an important role in maintenance of market efficiency. That

---

<sup>1</sup> Faculty of Economics, University of Kragujevac, dimitrijevicd@kg.ac.rs

role is seen through the fact that financial statements indicate what the financial position was like in the past, what it is like now and what it will be in the future. Most of financial statements are composed by following the principles of financial reporting, as well as bases of International Accounting Standards and International Financial Reporting Standards. The statements formed in this way offer a real financial image of companies' business, as well as the results of their business. Apart from the existence of many options that are offered in Financial Reporting Standards, in composing the statements there has to be objectivity, integrity and correct evaluation of both the ones responsible for composing the statements, and the management of companies.

However, one number of financial statements are composed with the aim of manipulating with financial results and financial position of companies. Manipulating with financial information can be the result of fulfilling individual aims of management or other employees, or showing even better financial positions of company in order to mislead future investors and creditors and to gain, in this manner, necessary capital. The intention to deceive the users of financial statements, at the first place existing and potential investors, and lead them on to decisions which are useful for the management of a company, management realizes by presenting false financial statements. This kind of malversation of accounting data can be seen both with small, anonymous companies and multinational companies. In contrast to property alienation, whose existence causes direct material damage to legal entity, fraudulent financial reporting is aimed at creating of false image of financial position of a company. Composing false financial statements can not only mislead existing and future investors, but also cause serious problems on the entire financial market, depending on the size and financial power of the company that composes false financial reports. The losses of investors, losses of trust in the quality of financial statements, but in the entire accounting system as well, initiation of lawsuits against individuals or legal entities which have carried out fraud, are all the possible consequences of frauds in financial statements. Frauds in financial statements, as well as all the other frauds, include the intention to carry out the fraud as well as the attempt of concealment. The frauds in financial statements can, most often, be carried out by the forgery of documents, which is the consequence of conspiracy of the management, employees and the third part. The biggest problem is that the frauds in financial statements are, very often late, and very difficult to be noticed. All the signals which can indicate frauds were previously been attributed to mistakes rather than intentions to carry out a fraud (if there wasn't a document, justification was that it is being late, if there wasn't concurrence with data, justification was that there is a mistake, most probably, etc.). However, with the appearance of large number of financial scandals which were the consequence of fraudulent financial reporting, the control of financial data became much stricter and much more detailed. This was all especially influenced by the fact that one number of the scandals have costed financial markets with losses of over several hundred billions of dollars.

According to International standards of revision fraudulent financial reporting presents criminal activity which is characterized by intentional misleading statements or omitting certain data or publishing them in financial statements (International standards and statements of revision, 2005<sup>1</sup>). The Association of Certified Fraud Examiners (ACFE) defines false financial statement as „intentional false presenting of material facts or accounting data which leads to the fact that the user of financial information that are presented within financial statements makes wrong decisions (Zabihollah, 2002). American Institute of Certified Public Accountants (AICPA) defines financial statement as „intentional incorrectnesses or omissions of the amount or publishing in financial statements, in order to deceive the users of financial statements.“<sup>2</sup> It can include:

1. Manipulation, forgery, or correction of accounting records or accompanying documents, which are used in preparing financial statements;

---

<sup>2</sup> <http://www.aicpa.org>, taken on 10 th July 2012.



2. Incorrect (false) presentations or intentional omissions of important events or transactions from financial statements;
3. Intentional incorrect implementation of accounting rules. (Stefanovic, 2000)

The consequences of false financial statements can be very unpleasant and sometimes even dramatic. Most often the management carries out the frauds in order to gain certain benefits. These benefits are always gained to the detriment of other groups of interest, which presents favourable effects for individuals in short term. In a long-term perspective the consequences are always negative and the ones who suffer, are the ones who weren't involved in financial frauds. The impairments that can emerge in this case can be direct and measurable by the level of realized losses or by the level of lost profits, but indirect as well, such as the lost shares of stockholders through dividends and capital profits. Opportunity costs through lost shares out of the best rejected investment alternative are good examples of certain, but not easily measurable impairments. If add to this the lost of trust of investors in the quality of financial statements, contribution to the deepening of financial asymmetry and non-efficiency of capital market and destabilization of financial system, then it becomes much clearer the significance of the problem of composing false financial statements.

### Causes of fraudulent financial reporting

Many corporate malversations realized during the period of 2000-2002, including the frauds in financial statements as well (WorldCom, Enron), have created the crisis of trust on many financial markets in the world. Numerous financial scandals have caused the biggest „damage“ of financial sector in the USA, due to the fact that in this country the greatest number of frauds has occurred. Many frauds, which have been carried out in the last ten years in companies in the USA, have caused damage of over 15 billion dollars to the financial system of the USA through the fall in total market value of stocks of the companies in which the frauds have occurred. We will name only a few examples and causes of realized malversations in the work of companies:

- ***Incorrect financial statements and „editing“ of business books***-the examples of this kind of malversations are the frauds carried out in companies Qwest, Enron, Global Crossing, WorldCom, and Xerox, among others. In certain frauds as these there were over 20 individuals included, which were helping fictive business results to be published in order to deceive the users of financial statements;
- ***Inappropriate loans to managers and „corporate robbery“***- John Rigas (Adelphia), Dennis Kozlowski (Tyco) and Bernie Ebbers (WorldCom);
- ***Scandals caused by insider trading on the stock exchange***- one of the best examples of these scandals are Martha Stewart and Sam Waksal who were found guilty for using inside information while trading with the stocks of the company ImClone, when they gained additional profit, illegally.
- Malversations emerged during initial public offer of stocks by favoring or spin off stock trading- the examples are Bernie Ebbers (WorldCom) and Jeff Skilling (Enron);
- ***Excessive privileges of managers***- companies such as PepsiCo, Aol, Time, Warner, Ford, GE and IBM have been criticized for excessive privileges which were offered to their managers (bonuses, additional privileges, luxurious presents), since the examples of numerous malversations have shown that precisely these benefits encouraged many managers to falsify financial results of the companies so that even better results could lead to gaining these benefits;
- ***Too high compensations paid to managers (including both monetary and compensations in stocks of a company)***- referring to malversation named before, it should be mentioned that many managers, including Bernie Ebbers (WorldCom), Richard Grasso (NYSE), have received

enormous monetary compensations and compensations in the form of stocks for achieved results, which were later proven as falsely presented;

- ***Giving beneficial credits to the companies in order to achieve individual goals-*** financial institutions, such as Citibank and JP Morgan Chase, have allowed certain companies (Enron) beneficial credits so that they can, in return, have the opportunity to earn hundreds of millions of dollars on transactions of certain derivatives using either inside information or certain privileges;
- ***The frauds that are carried out by employees-*** even though they haven't been presented in media as the frauds in financial statements, various other types of frauds (steals, tax frauds, money launder, etc) have caused great impacts on financial markets, since the amounts of the damages which were created in these frauds in some countries went over 3 billion dollars.

Each of the problems mentioned before is the consequence of certain pressures (most often for even better business result or for solving personal problems), possibilities and justifications. At the same time factors mentioned before are the elements of so-called „triangle of criminal activity“, that is shown on the Picture 1 (Coenen, 2008):

**Picture 1-The triangle of criminal activities**

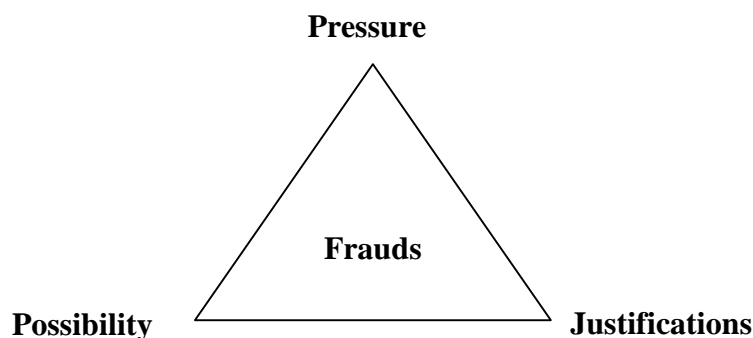

***Pressure*** is related to some event or circumstance in private life of individual which leads to the demand for money and in this way it motivates the fraud. Such motivation is usually based on financial needs, but there can also be other aspects of pressure. Each individual who carried out a fraud was under certain pressure. Some of the examples of pressure which motivates the frauds in financial statements are financial losses of companies, impossibility of fulfilling certain business expectations, expectations concerning profit of stock holders, or impossibility of survival with the competition in business. Furthermore, the bonuses that are realized by managers can be additional pressure. These bonuses are very often measured in millions of dollars, so each insignificant fall of company's stocks which is the consequence of poor doing business, can lead to enormous losses of managers concerning their bonuses. As regards ***justification***, in global statement ACFE it is noted that 88% of reported offenders of fraud previously didn't have criminal record. The question is how, then, these offenders justify their behaviour which leads to frauds. They simply justify their criminal act by certain circumstances. According to certain research, it is shown that the offenders of frauds always possessed knowledge and possibility of committing the fraud. Research have shown that the offenders have long-term experience of working in the company where they committed criminal activity. Almost every fraud includes justification of its fulfillment. Many managers justify fulfillment of a fraud by assertion that „the obligation of management is to protect stock holders and to keep the price of stocks as high as possible“, or „all the others are using aggressive accounting practice“, or „it is for

the benefit of the company“. *Possibilities* for carrying out frauds are great in the presence of weak and careless management and inadequate internal control. When motivation is joined with such possibilities, the potential for carrying out frauds becomes even greater. Most often, the possibilities of management for carrying out the frauds in financial statements represent the weakness of managing board of a company, insufficient internal control and offered possibilities to „mask“ the frauds behind complicated structure of transactions and overall business of a company.

The triangle of frauds is explained by ethical element of committed fraud. However, there are great number of factors that affect fulfillment of „perfect fraud“ in financial statements. In order to understand such frauds here will be explain eight important factors which can form favourable environment for fulfillment of the fraud in financial statements:

**1. The level of economy development-** in developed economy the conditions for business are much better than in undeveloped economy. Such conditions enable managers of companies to realize even better results and in this way present themselves as „successful“ employers. Frauds occur when economy reaches the peak of its development or when it comes to the fall of economy development. Then, it is expected of such „successful“ management to give the results on the same or better level in comparison to the one on which it was in the time of economy development.

**2. Decay of moral values-** one of the important factors that create „favourable“ conditions for carrying out frauds is the decay of moral values which originated in many countries in the previous period. Many research have shown that the number of frauds in school, at work or in similar situations has mounted to a great extent. All this is a consequence of increasingly difficult financial situation in many countries, arisen in global economy crisis. Such thinking and actions have caused that significant part of individuals which carry out frauds consider that they were forced to do that due to economic difficulties or that they justify their behaviour with economic crisis;

**3. Inadequate encouragements-** earlier in the paper it was mentioned that by excessively high bonuses the pressure on managers is created, which is why they resort to composing of false financial statements in order to achieve even better results or keep the price of stocks on as high as possible level. These bonuses can be in the form of money or in the form of stocks of a company. During 1997 Bernie Ebbers, one of the managers of WorldCom, received the net salary of 935 000 dollars. However, by using the right to bonuses based on good results, which were later proven to be the result of frauds in financial statements, he received 409 million of dollars bonus, which were paid in stocks of the company. This act of a successful manager encouraged many others, as well, to resort to manipulations in order to achieve additional bonuses especially paid in stocks of a company;

**4. High expectations of analysts-** one of the factors which also create great pressure on management of companies is high expectations of analysts concerning business results of a company, especially in short-term period. It is often the case that, due to good results of company, analysts expect if not the same, than even better level of business results in the future. The greatest expectations of analysts are concerned with the price of stocks of a company. Taking into account that very often many factors which are not under control of management (for example the fall in the demand for the products of company due to global crisis) influence the price of stocks, setting agreeable price of stocks on high level by analysts creates pressure on management to resorts to composing of false financial statements so that the results of business could be even better. In this manner by controlling business result, management tries to keep under control the price of stocks as much as possible, in order to fulfill demands of analysts and, therefore, of their investors, as well.

**5. High level of debts of companies-**the factor that is especially present in the time of global economy crisis. The obligations have enormous pressure on management to realize even better results in business to cover high expenses of interests and to settle received payments on time, so as not to imperil future debts. For example, during 2000, Enron increased its obligations from 1, 8 billion dollars to 10, 5 billion. Furthermore, WorldCom had over 100 billion dollars of debt immediately

before its bankruptcy. During 2002, 186 companies, which were quoted on the market of the USA, among which there were WorldCom, Enron, Adelphia, Global Crossing, had 368 billion dollars of debt before they submitted the request for bankruptcy<sup>3</sup>.

**6. *Insufficiency in auditors independance-*** this factor appears in situations when certain auditor agencies have consultant deal with a company. In these situations auditors very often, who should objectively analyze doing business of companies and point out the possibility of fraud in financial statements, are, actually, the ones who advise companies how to, using certain methods, both legal and illegal, cover the loss or increase profit in business. For certain auditor agencies consultant deal is so important that the very work of auditor is marginalized in order not to lose very important contract. In these and similar situations auditors lose their focus and become more advisors of a company than auditors and supervisors of its business. One of the best examples are the auditors of Arthur Andersen company which carried out revision of the work of Enron. After the investigation of financial scandal in this company, it was shown that many auditors were involved in fulfilling of these manipulations, primarily by giving advice in which way one can cover the losses and present even better business results.

**7. *Greed of individuals-*** greed of individuals from the structure of management, greed of banks and investors are also one of the factors that affects the appearance of fraudulent financial reporting. Each of the above mentioned has benefits form strong economy and good results of companies. They accept bad news in a hard way, so they are ready to do anything in order to preserve good results. For example, in the case of Enron many commercial and investment banks have earned hudreds of millions dollars on profitable bank transactions of Enron, knowing at the time about the problems of the company, and not informing other stock holders about it. Even when in October 2001, Enron was abandoned by several managers, when the story about poor business of Enron was put in public, many analysts advised that it was good to invest in Enron in order to protect their own interests.<sup>4</sup> Furthermore, many law firms which earned large sums of money in business with Enron did not indicate the problem, but they deliberately helped certain legal documents to be realized, even though they knew that such documents are the consequence of various manipulations in financial statements. Finally, three big credit agencies Moody's, Standard & Poor's and Fitch/IBC, which were familiar the problems of Enron, did not warn the investors on time.<sup>5</sup>

**8. *Mistakes in education of staff-*** this factor includes several mistakes in education. Mistakes occur in education of students at universities when it comes to questions of respect of ethical rules of business. It is difficult at university to explain to a student what is good and what is bad, since he/she is already formed personality, but he/she can be guided to respect the ethical rules of behaviour in business of companies, to respect competition and not to fulfill his/her personal interests through the results of a company. Mistake in education is also insufficient training of staff concerning frauds in financial statements. Since all the financial scandals emerged as the consequence of fraudulent financial reporting of recent date (mostly the period after 2000), at many universities the disciplines which deal with the analysis of emersion and preventing frauds in financial reports are still being developed. Moreover, big mistake is also, insufficient training of the existing accounting staff. In the process of development of accounting staff great part have both the state with its agencies and the accounting profession which, through its organizations, has to carry out constant training of staff, in order to prevent the development of frauds in financial statements.

The presence of certain or combination of several above mentioned factors leads to creation of „favourable“ environment in which the conditions which correspond to individuals, most often to

---

<sup>3</sup> <http://www.bizjournals.com>, taken on 1st June, 2012

<sup>4</sup> <http://www.fool.com>, taken on 2nd of June, 2012.

<sup>5</sup> <http://www.cdfa.net>, taken on 2nd of June, 2012.

management of a company, are being created, which help them to perform various manipulations in financial statements.

### **Motives for frauds in financial statements**

Motives for carrying out frauds in financial statements are numerous. In certain situations the wish to maintain high price of shares and in this way to satisfy interests of stock holders and other investors is a huge motive for committing the fraud. On the other hand, increasing the price of shares is the consequence of management's desire to realize in this way additional bonuses and premiums. Certain managers of branches of large companies, in situations when they are expected to achieve good results, subject to pressure and resort to manipulations which lead to the fraudulent financial reporting. Creating more favourable image about financial position of the company has strong motives with management. The reasons for which management seeks to present good and stable business with entering trends of the results are, most often:

- Attracting new and maintaining of trust with existing investors;
- Increasing the price of shares;
- Realization of management's bonuses (prizes);
- Delaying income taxes;
- Avoiding the danger of taking over.

Many research on motives of management for forming false financial statements name following reasons:

1. Personal motives:

- Realization of profit bonuses;
- Job assurance;
- Personal satisfaction;

2. Expectations of capital market:

- Coordination with analysts' expectations;
- Realization of even (steady) profit;
- Realization of a set standard of income and results;

3. Specific circumstances:

- Managing credits and indebtedness of a company;
- Issue of shares or other types of securities;
- Merging with other companies;
- Forming of a new management;
- „Waiting for better times“.

1) ***Personal motives*** –these motives serve for fulfilling of personal goals of an individual due to financial difficulties or, pure desire to earn more money. **Realization of profit bonuses** depends on the results of company's business, and for this reason, many managers resort to „enhancing“ of financial statements through various manipulations. **Job assurance** is a motive which forces many managers to use false financial reporting, since, only by presenting good results of business, their job is safe, too. **Personal satisfaction** as a motive appears in situations when management wishes that

## **FRAUDULENT FINANCIAL REPORTING – ESSENCE, MOTIVES AND METHODS**

---

company which is managed by them to be better than competition or the best in its business field. Due to these personal wishes, management resorts to manipulations so that the results of business be much better;

2) **Expectations of capital market** – Realization of profit is in hands of company's management. However, market positioning and the value of company through price of shares is in hands of analysts on the capital market. Realization of profit which is not followed by increasing of price of shares presents great disappointment and the loss of large sum of money for stock holders. Precisely because of this, the pressure and expectations which come from capital market are great motive for using of fraudulent financial reporting.

3) **Specific circumstances** – certain circumstances in business, on capital market or specific social and political circumstances can force managers to use manipulations in financial statements.

- **Managing credits and indebtedness of a company** – in certain situations managers, very often, manipulate with data in financial statements in order to present successful business and avoid additional interests expences and other financial expences;
- **Issue of shares or other valuable papers** –in situations in which a company issues shares on the market for the first time, or issues other types of valuable papers (securities) in order to gain additional capital, managers resort to manipulations to present better financial result;
- **Forming of a new management** - when it comes to change in management team in company, the new team wants to ensure for themselves better initial position. This can be useful for new management for two reasons: one is that in this way they can ensure enough space due to poor results of the former structure of management, and the other is that in this way, they can ensure lower rate of profit they will later on their business compare with.
- **„Waiting for better times“** – if company has problems, management often resorts to manipulations in financial statements in order to present stable business and maintain company for some better times which they evaluated that should come. In this way management creates certain backups in business in order to persist current difficulties, hoping that the future will bring new chances in business and, therefore, larger profit, as well.

### **Methods of fraudulent financial reporting**

Many financial scandals, which were the consequence of numerous malversations in financial statements, have indicated that there are numerous and various methods of composing false financial statement. In order to prevent frauds in financial statements it is necessary to perceive and analyze all these methods of malversations. The most common scheme of frauds in financial statements can be classified in the following way:

1. Fictive incomes;
2. Chronological incompatibility of admitting expenses and incomes;
3. Covering expenses;
4. Irregular publishing of financial data.

These are just some of the methods of manipulations of financial data. More detailed classification would demand much bigger space and time, so that in this paper will be given the review of only basic methods of fraud. However, one should have in mind that very often in practice, it comes to the combination of these methods, which makes it more difficult both the discovering of frauds and preventing the future ones, as well.

**1) Fictive incomes** – include incomes recorded from sales which have not occurred. Fictive incomes are most often shown based on false invoices issued to false or non-existing buyers. However, fictive incomes can emerge based on the invoice issued to existing buyers. For example, a fictive invoice can be prepared but not sent (most often it is done at the end of a financial year) since products or services based on which is, allegedly, an invoice issued do not exist or have not been sent. At the beginning of the following period these invoices are being annulled. Moreover, fictive incomes can emerge when the existing invoices issued for the existing buyers are increased to a certain amount, and in this way the incomes are being presented in a much larger sum than they really are. International Financial Reporting Standards have predicted the following possibilities when the sale incomes should be approved:

1. A company transferred certain risks and benefits from the ownership of goods to a buyer;
2. Company does not keep the right to manage the goods further on in the extent that is usually connected with the ownership rights of goods, as well as the real control of the sold goods;
3. The income sum can be measured reliably;
4. Economic benefits related to transaction will probably be merged into the company;
5. The expenses which have arisen or the expenses which will arise in relation to that transaction can be measured reliably. (IFRS 18 – Incomes, 2003)

Very often companies resort to recording of sale incomes although all the necessary conditions for performing transaction are not fulfilled, which, according to the regulations of International Financial Reporting Standards, means that the sale incomes cannot be acknowledged. Moreover, the problem occurs in situations when the transaction is started at the end of a year, all the necessary conditions for transaction approval are not fulfilled, and will be fulfilled in the following year. Respecting the regulations of International Financial Reporting Standards, the sale incomes in such transactions should be approved in the following year when the transaction ends. However, companies resort to manipulations and these incomes are published at the end of the current year, by which they „puff up“ the incomes.

**2) Chronological incompatibility of admitting expenses and incomes**- includes the recording of incomes and/or expenses in periods in which they have not emerged (transferring of incomes and/or expenses in the following period or recording in the current period although these incomes and/or expenses are yet to occur in the following). According to International Financial Reporting Standards, the incomes and expenses which are related to the same transaction or other event, are approved at the same time, and this process is usually described as confrontation of incomes and expenses (IFRS 18 - Incomes, 2003). The mentioned standards also influence the fact that „the income cannot be acknowledged when the expenses cannot be reliably measured, and in these circumstances any kind of compensation, received in advance for the sale of goods, is acknowledged as obligation“ (IFRS 18 - Incomes, 2003). The example of such manipulation can be the case when the management of some company makes a decision to, for example in December this year, publish realized incomes from sale, but the expenses emerged in this transaction are published in January the following year, that is, in the following accounting period. The result of deliberate non-compliance to accounting standards in this case, would be overestimating of the company's profit in the period in which the incomes have been published, and also underestimating the profit in the following period when the expenses are published. One of the causes of chronological incompatibility of incomes and expenses is *untimely acknowledging of incomes* where the main problem is when to acknowledge the sale, and therefore, the sale incomes. Earlier in the paper basic conditions, which are defined by International Financial Reporting Standards, and which have to be fulfilled in order to acknowledge the incomes, have been given.

## FRAUDULENT FINANCIAL REPORTING – ESSENCE, MOTIVES AND METHODS

According to the interpretations the income is acknowledged if the salesman delivered goods and if the invoice has been issued, also, if it was agreed, that the goods are kept with the salesman until it is taken over. The essence of manipulation is that the offender, with the intention to present falsely the amount of realized incomes, usually at the end of reporting period, issues the invoice of sold goods which have not been delivered yet, and with which all the risks and benefits of its sale have not been transferred to the buyer. *Recording of expenses in wrong period* is the type of manipulation with expenses in order to present better business results. Through this manipulation the expenses are most often transferred to the following period and due to this there is no chronological compatibility of these expenses with corresponding incomes.

3) *Covering expenses*- by manipulation with expenses the management of a company wants to present company's business much better, in other words, to lower or to cover the expenses so that the company seems more profitable and liquid. Moreover, the examples of frauds in financial statements from the former period have shown the fact that this type of manipulation is much easier to perform than it is the case with income manipulations, and therefore, they are more difficult to discover. There are 3 methods of covering expenses:

1. Mistakes in expense recording;
2. Capitalization of costs;
3. Presenting costs related to future period by current.

1) *Mistakes in expense recording*- this method is used in situations when management wants to „impress“ its stock holders or creditors (most often bankers) by presenting larger sum of the profit. There are many techniques of hiding costs which were used by many companies in previous period:

- *Non-recording of transaction costs* –this technique is based on simple non-recording of transaction costs or recording of only one part of costs;
- *Non-recording of increased costs or costs from the past*- it happens that some companies deliberately fail to record certain increased costs which emerged from regular business in order to manipulate with costs and presented income;
- *Non-recordnig of costs or lowering costs which emerged from aggressive usage of accountancy evaluations*- this technique presents flexibility of management in choosing accountancy politics and accountancy evaluations in order to hide certain costs.

2) *Capitalization of costs*- There is no cost that could not be expressed as asset, that is, activated. Unjustified capitalization of costs leads to the fact that, for example, costs of current equipment maintenance, instead of being activated as expenses of current period, due to attributing the value of equipment is being increased and, therefore, the value of net property, as well. At the same time, due to presenting lower expenses, the presented result would be higher. Hence, better financial position and higher result are presented, in comparison to the realized ones. In the following years, through disregarding of equipment, activated costs for the current maintenance will be disregarded, as well, which means that the costs of amortization in the following years, more precisely, during the remaining century will be higher, and presented result will be lower in comparison to the result which would be established if manipulation by activating did not occur. Malversation of capitalization can be performed in two ways:

- By admitting as means the cost for which there is no probability that it will bring any economic benefits in the future, or that the rate of future economic benefits cannot be reliably estimated, and
- Overestimating the sum of costs which otherwise satisfy the conditions for capitalization.



3) Presenting costs related to future period by current – the motive which is hidden behind such manipulation is the desire of management to present in current accounting period higher costs in order to: lower the profit so that the sum of profit tax would be lowered too, or the desire of management not to let sudden increase in profit, but its steady flow through periods in order not to influence the increase or the fall of share price.

4) *Incorrect publishing of financial data* - International Financial Reporting Standards, according to which in most of the countries financial statements are being composed, demand that financial statements show all the necessary information to the users of these statements so that, based on them, right business decisions could be made. Therefore, all the responsibility lies on the management of companies and people responsible for composing financial statements, for presenting objective and relevant financial data on results of business and financial position of a company. Wishing to present better business results the management very often do not show all the necessary data, that is, avoid to show certain data in current year, or do not show additional explanation in references of financial statements which is necessary so as to understand certain actions of management.

## Conclusion

Relevant and reliable financial statements are the most important source of information for current and future investors for making right decisions. However, when composing financial statements it is necessary to fulfill many different demands of various users, which in many situations leads to manipulations with data which are presented in financial statements and creation of false financial statements. In order not to allow such frauds, in companies there has to be developed consciousness about the necessity of presenting relevant and reliable information. Global economic crisis, which overtook world market at the end of 2008, indicated that number of frauds has tendency to increase. Precisely in these situations many people want to present, through manipulations, false image of their business in order to fulfill various short-term goals such as gaining extra profit, not presenting the loss on business, avoiding taxes, etc. All this implies that current financial regulation on financial markets is not strong enough to prevent possible future crises. Because of this, demands for more rigorous control of financial market and their business are even greater, and for creating new conditions in which all involved would have better competitive position and in which one must not manipulate with financial statements. If, within a company, there is no existence of controlling system and system for supervision of quality of process of financial reporting itself, and if the owners of capital, investors and other stake holders do not have at their disposal the instruments for protection of their interests, it is clear that, due to this, frauds will be more frequent and numerous. With the existence of adequate control of composing financial statements in companies, both internal and external, the best proof is, both to the owners, and investors as well, financial statements to present truly and fairly the position of property and finance as well as the success of company's business.

## References

- Albrecht S., Albrecht C., And Zimbelman M., (2009), „*Fraud Examination (Third Edition)*“, South-Western Cengage Learning, USA;
- Coenen T., (2008), „*Essentials of Corporate Fraud*“, John Wiley & Sons, Inc, New York;
- International Financial Reporting Standards, IFRS 18 - Incomes, Association of accountants and auditors of Serbia, Belgrade, (2003);
- „International standards and statements of revision“, Association of accountants and auditors of Serbia, Belgrade, (2005);

## **FRAUDULENT FINANCIAL REPORTING – ESSENCE, MOTIVES AND METHODS**

---

Stefanovic, R., (2000), „*Preventing and disclosing of false financial statements*“, Accountancy 11/2000, Association of accountants and auditors of Serbia, p. 3-11;

Zabihollah R., (2002). „*Financial Statement Fraud – Prevention and Detection*“, John Wiley & Sons, Inc., New York;

Wells J., (2004), *Corporate Fraud Handbook*, John Wiley & Sons, Inc., New Jersey;

Wells J., (2005), *Principles of Fraud Examination*, John Wiley & Sons, Inc., New Jersey;

[www.aicpa.org](http://www.aicpa.org)

[www.bizjournals.com](http://www.bizjournals.com)

[www.cdfa.net](http://www.cdfa.net)

[www.fool.com](http://www.fool.com)

# FROM ACTIVITY-BASED COSTING AND TARGET COSTING TO THE REALIZATION OF COST LEADERSHIP STRATEGY

Ljilja Antić<sup>1</sup>

Bojana Novičević<sup>2</sup>

**Abstract:** *Dynamic and turbulent environment entails the application of costing methods that significantly differ from traditional methods. Each of these systems, with its specific characteristics, achieves its goals in certain phases of a product life cycle. However, constant changes impose the need for the combination of certain costing systems so that enterprises could realize their defined strategies. Activity-based costing can be applied in different phases of a product life cycle by producing information that are necessary for achieving the target cost. Target costing is a technique with which ideal costs that maximize profit during the entire product life cycle are created. The application of target costing and its combination with the data obtained on the basis of activity-based costing result in a higher level of transparency of overhead costs, facilitate their calculation per objects of expenditure and find ways in which they could be reduced.*

**Keywords:** *Activity-based costing, target costing, cost reduction, cost leadership strategy*

## Introduction

Within the borders of highly competitive market, manufacturers do their best to offer products characterized by high quality and functionality at prices that are lower than the ones set by their competitors. With the purpose of achieving significant advantage over their competitors, enterprises select appropriate strategies. One of the strategies, whose efficient realization influences the efficiency of an enterprise in a dynamic and uncertain environment, is the cost leadership strategy. Cost leadership strategy is based on the concept according to which the price is the major means of competition among enterprises. Enterprise which applies this strategy has a task to manufacture a product that is similar to their competitors' products but at lower costs. Efficient management of an enterprise will be able to achieve the lowest total costs per unit of a product while maintaining the satisfactory profit.

Constant tendency towards cost reduction has become extremely popular in a situation when the efficiency of an enterprise depends on whether it is a part of the most efficient value chain or not. Cooperation with other enterprises with the purpose of obtaining certain product components or the use of materials that will reduce product costs without changing the product quality are some of the ways in which manufacturing costs can be reduced for the purpose of achieving and maintaining the competitive advantage on the market.

Great number of activities need to be realized within this process, starting with the conception of the product idea and ending with the delivery of a product to the end customer. Strategic business of an enterprise's management is reflected in identification and analysis of activities that are realized in an enterprise. Breakdown of an enterprise's business processes into appropriate activities is of special importance for the cost leadership strategy. The situation is such due to the fact that the insight into the

---

\*

<sup>1</sup> Faculty of Economics, University of Niš, ljilja.antic@eknfak.ni.ac.rs

<sup>2</sup> Faculty of Economics, University of Niš

## **FROM ACTIVITY-BASED COSTING AND TARGET COSTING TO THE REALIZATION OF COST LEADERSHIP STRATEGY**

---

activities and their contribution to the creation of value for the customer enable identification of the areas in which significant cost savings could be made. For the purpose of making significant cost savings, managers need to have an adequate information background. This information background can be offered by contemporary systems of costing and cost management. In a dynamic and turbulent environment of the present day, the realization of an enterprise's defined strategy requires the application of several costing systems.

In that sense, this paper will deal with activity-based costing, which enables identification of activities that are necessary for product manufacturing and their division into value-added and non-value-added activities. The second part of the paper will point to the main characteristics of target costing, that is, the costing system that starts from a product's selling price and defines the allowable target cost at which the product must be manufactured. Finally, the example of rotary lip seal manufacturer standing for the part of the most efficient value chains in the USA will be used for establishing the connection between activity-based costing and target costing, all with the purpose of realization of cost leadership strategy.

### **Conceptual framework of activity-based costing**

Unavoidable information background underlying the continuous improvement of modern enterprises' business is reflected in activity-based costing (ABC). The situation is such due to the fact that the achievement of goals, such as the establishment of standards, stock valuation etc., which are characteristic of traditional systems of costing, cannot bring the leadership position to an enterprise within a dynamic and turbulent environment. Activity-based costing provides data that are useful for detailed analytic consideration of activities that are realized in an enterprise, thus offering a solid basis for long-term business planning and improvement. Business improvement refers to a better formulation and implementation of strategy, creation of an adequate organizational structure and improvement of enterprise's performances through improvement of product design and continuous cost reduction in the process of realization of activities.

Activity-based costing is the system that provides managers with information which could be useful for external and internal improvement. With the purpose of manufacturing a product in accordance with the features that will appeal to the customers, it is necessary to realize certain activities. Activities stand for the conceptual framework of activity-based costing. In that sense, products consume activities whereas activities consume resources. Contrary to traditional systems of costing, which allocated costs to products on the basis of cost drivers related to the scope of activities, ABC "pushes" total costs into the centers of activities and connects them with the products on the basis of cost drivers that are related to the physical scope of production and on the basis of cost drivers that are not related to the physical scope of production.

The process of cost allocation within the system of activity-based costing consists of four iterations: (Weygandt et al, 2008, p. 152):

- Identification and classification of activities involved in the manufacturing process and allocation of manufacturing overhead costs to corresponding activities,
- Identification of cost drivers related to costs of activities,
- Calculation of overhead cost rate for each cost driver and
- Allocation of manufacturing overhead costs from activities to products based on overhead cost rate for each cost driver.

Therefore, cost allocation is performed at two levels. Cost resources are allocated to activities on the basis of resource cost drivers, that is, the quantity of resources that are necessary for the

realization of certain activities. Furthermore, activity costs are allocated to objects of expenditure (cost carriers) on the basis of activity drivers. Activity drivers measure the number of individual activities that are realized in the process of manufacturing a product.

Dynamic and turbulent environment imposes the need for the utilization of high manufacturing and information technologies, which results in the enormous increase in the share of overhead costs in the cost structure. Share of direct labour costs decreases, which causes the problem of allocation of increased manufacturing overhead costs in situations when the relationship between direct labour and overhead costs is not recognizable. Basic novelty introduced by the system of ABC is reflected in the fact that this system recognizes that the majority of enterprises' resources are not used for direct manufacturing of products but for the realization of activities that support the manufacturing processes and the sale of products and services (Malinić et al., 2011).

Plenty of financial and non-financial information that can be found within the bases of the system of ABC result in its development into activity-based management (ABM) that occupies an important role in the process of implementation and realization of an enterprise's defined strategy (Antić et al., 2010). The strength of ABM is reflected in the provision of information on the basis of which managers can obtain answers to the following questions (Kaplan et al, 1998):

- In which way can an enterprise achieve a better position on the market and
- How can internal capacities be improved and how can costs per unit be reduced.

One of the goals of activity-based management is identification of value-added activities and non-value-added activities. By examination of the list of activities that are realized in an enterprise, managers conclude whether certain activities are necessary and whether they are realized efficiently. In addition, it is very important to understand the relationships among activities and to build the system of performance measurement that stands for an important element of report on non-value-added costs. Costs resulting from non-value-added activities can be eliminated without affecting the product quality and performances while at the same time contributing to the reduction of manufacturing costs.

The primary argument in favour of the application of the systems of ABC/ABM is reflected in their preciseness in comparison to traditional systems of costing. ABC collects data on individual activities to the finest details, thus offering a solid basis for the making of adequate business decisions. Identification, generation and finding of these details requires much effort. Nevertheless, operative plans, based on the projection of details, stand for the powerful tool for the management of an enterprise. Activity-based costing arrives at total costs on the basis of activity and cost drivers that can at the same time serve as the measurement of performance and progress of realization of individual activities. ABC enables managers to focus on real sources of costs, which results in adequate implementation and realization of an enterprise's defined strategy.

### **Target costing**

Target costing is a market-oriented approach directed towards achieving the lowest possible costs as the basis for achieving competitive advantage. Since the highest possibility of cost reduction is found in the earliest phases of product life cycle, this system efficiently finds these possibilities and directs enterprises towards the realization of their defined strategies. Its impact in the process of cost reduction makes target costing an important strategic tool that the management uses for achieving competitive advantage. In the process of determining the target cost, it is important to focus on the creation of real possibilities for each product in an enterprise's production and sales line to contribute to the realization of the desired profit. As a market-oriented approach, target costing has two primary goals (Lalević, 2007). The first goal is to satisfy the customers' needs, that is, their demands related to

## **FROM ACTIVITY-BASED COSTING AND TARGET COSTING TO THE REALIZATION OF COST LEADERSHIP STRATEGY**

---

the product's quality, functionality and price. The second goal is focused on determining the purchase price of the components and the establishment of partner relations with the suppliers.

Determination of the target cost starts from a product's selling price that is the reflection of market developments and competition. The target profit is subtracted from the selling price as the maximum allowable price at which a product must be delivered, thus obtaining the target cost.

The target selling price is formed on the basis of information that an enterprise obtains from its customers within certain market segments. In the process of formation of the target selling price, important information are obtained by external analysis, especially analysis of the competitors. By constant comparison of its own products with the products offered by the competitors, an enterprise tends to form the price that ensures certain market position. It is important to take into account that the target selling price must be acceptable for the customers while at the same time offering the possibility for the realization of profit on the part of an enterprise.

On the basis of an enterprise's abilities and potentials, top management defines the target profit. The target profit must be in accordance with an enterprise's strategic plan and its expectations.

The target cost is the allowable cost at which an enterprise's product must be manufactured. Since this cost does not reflect the current abilities and potentials of an enterprise, assessment of the running costs is performed with the purpose of accurate determination of the target cost. This implies the evaluation of the running costs at which a concrete product is manufactured. In that context, the determination of the target cost involves the realization of the following activities (Lalević, 2007):

- Market research with the purpose of obtaining information on the customers' needs and desires and with the purpose of identifying the target cost of a segment,
- Analysis of competitors with the purpose of obtaining information on the competitors' behaviour on the market, including all advantages and disadvantages,
- Identification of market niches with the purpose of creating real information background for making relevant decisions.
- Recognition of customers' demands with the purpose of obtaining information on the customers' impulses regarding new product concepts,
- Determination of product features with the purpose of defining specific product requirements and determination of the potential target profits for each product,
- Determination of market prices with the purpose of checking their acceptability for the customers and
- Determination of the target profit with the purpose of obtaining information on the product's profitability.

Focus of target costing on cost reduction in the phases preceding the manufacturing phase stresses the role of engineers who have to create a product with certain features while paying attention that the costs do not exceed the target cost. In addition, target costing stresses the role of a detailed profit plan. Profit plan has to be made in such a way that it respects short-term and long-term goals of an enterprise. Long-term goals and strategy of an enterprise must not be disregarded so that the profit could be made within a short period of time. Without long-term planning of profit, managers can impose a strong pressure on the process of cost reduction and make the defined target costs unrealizable. In case the managers impose a strong pressure on the cost reduction process with the purpose of achieving short-term profitability, an enterprise could find itself in a situation to (Brausch, 1994):

- reject a product on the edge of profitability that can bring above average profitability on a long-term basis or

- reduce product costs, thus making a product impossible to manufacture in the current period, although long-term focus on cost reduction could bring an enterprise into the position of a cost leader.

Although it is focused on the phases that precede the manufacturing phase, target costing takes into account the costs of an entire value chain. The emphasis here is on the fact that the suppliers possess significant information that can be useful in the process of cost reduction. Therefore, establishment of strong partner relations with the suppliers can be the key basis for achieving cost competitiveness. Another advantage of target costing is reflected in the fact that it makes costs more transparent and clear, which increases chances of potential cost reduction and facilitates the determination of which direct and overhead costs can be reduced so that the losses could be minimized (Horvath et al., 1998).

### **Integration of ABC and target costing with the purpose of reducing product costs**

Calculation of “ideal” costs with simultaneous maximization of profit is one of the characteristics of target costing. This system is primarily directed towards the phase of product design and development where there are the greatest possibilities for cost reduction. The situation is such due to the fact that under contemporary business conditions it cannot be waited for the product to enter the manufacturing phase in order to be realized what kind of influence the decision on the product design has on the costs. Target costing is often referred to as the “design profit” due to the fact that engineers, rather than accountants or managers, bear responsibility for the costs. When a product enters the manufacturing phase, activity-based costing can be used for the purposes of cost reduction. Information obtained on the basis of ABC can be very useful for the realization of cost leadership strategy and application of target costing in an enterprise. This system enables managers and engineers to express the required features and quality of products in the costs of future products with the purpose of realization of cost leadership strategy.

Illustration of the relationship between activity-based costing and target costing with the purpose of cost reduction will be provided on the basis of the example of rotary lip seal manufacturer that stands for the biggest supplier of car manufacturing companies in the USA and a part of one of the most efficient value chains (Horvath et al., 1998). The function of rotary lip seal is to prevent leakage of oil and air into the cylinder head. Due to the specifics of the manufacturing process and the product itself, this manufacturer performed standardization of material costs, labour costs and overhead cost rate. All indirect manufacturing costs were involved in the standard overhead cost rate for each part of an enterprise. Total costs were obtained by adding standard direct material costs, standard direct labor cost and indirect labor overhead rate. Since this supplier stands for a part of the value chain, transfer prices defined at the chain level had to be taken into account during the process of determining the standard costs. Transfer prices were determined on the basis of negotiations between the main car manufacturer and all related suppliers and they represented the maximum internal selling price. This maximum internal selling price always depends on the customers’ demands and must not exceed the amount that they are willing to pay.

Implementation procedure regarding new systems of costing with the purpose of realization of cost leadership strategy in the case of rotary lip seal manufacturer was performed at two levels. The first level was characterized by the Functional analysis that represents the component part of target costing. This analysis was performed with the purpose of obtaining the answer to the question regarding whether it was possible to reach the target cost. The second level was characterized by the integration of ABC with target costing with the purpose of pointing to the real manufacturing overhead costs.

### **Functional analysis –TC technique with the purpose of cost reduction**

Target costing represents the system that is based on the price of a product rather than on its costs. Price of a product is determined by the customers' demands and the competitors. It often happens that enterprises incur additional costs with the purpose of improving their products and delivering higher value to the customers, thus achieving higher profit. The amount of achieved profit depends on the customers' preferences and desires to pay for a certain product.

With the purpose of improving business and reducing product costs, rotary lip seal manufacturer carried out functional analysis that is the component part of target costing. Functional analysis is part of Value Engineering (VE) technique that represents a powerful tool in the process of cost reduction. The task of this technique is to ensure that the product reaches primary level of functionality that will satisfy the customers at acceptable costs. (Antić et al., 2011). This technique presents value as the ratio of functionality to costs. The aim of functional analysis carried out by rotary lip seal manufacturer was to identify the product functions and the existent or necessary combination of functions related to individual products. In addition, there was an attempt to determine which product components ensured these necessary product functions. Functional analysis consisted of four parts (Horvath et al., 1998).

First part of the analysis referred to the identification of product components and their classification into physical and non-physical. Physical components of rotary lip seal are: case, compound and spring. Identification of non-physical product components, such as assembly, was important due to the fact that this product component was considered to contribute to the increase of value in the manufacturing phase.

After the identification of the components, analysis of standard costs which stand for the only available information basis was performed. Analysis of standard costs provided data on the share of standard costs in each product component.

Third part of the analysis referred to the identification of product functions by using appropriate questionnaires. Purposes of obtaining data that would be relevant for further analysis required the organization of an interview with appropriate engineers and the most significant customers. The fact that the engineers believed that the product functions could not be separated one from another was of special importance. They also claimed that the required value could be delivered to the customers if the appropriate combination of product functions was found. Examinations showed that the following four functions were of 85% importance for the customers: sealing ability, durability, precise fitting and appearance (Horvath et al., 1998).

The final part of the functional analysis was reflected in the organization of interviews and calculation of value index for each component. Value index served the purpose of measuring the ratio of cost to benefit. For this purpose, a matrix function-component was established, which was supposed to show the benefit of each component for a defined function. It was realized that in order for some product function to be at satisfactory level, value index should equal 1. If this value index was lower than 1, component costs would be higher in relation to the component's benefit for the corresponding function.

By detailed realization of the functional analysis and calculation of value index, the managers employed with the rotary lip seal manufacturer obtained the following value index for the stated components:



**Table 1. Value index**

Components	Relative portion of cost in %	Degree of importance of each component in %	Value Index (Importance of each component/ Relative portion of cost)
C1: case	49,89	17,7	0,35
C2: compound	9,58	55,0	5,75
C3: spring	27,06	17,8	0,66
C4: assembly	13,49	9,5	0,70
	100,00	100,0	

*Source: Horvath, P., Gleich, R. Schmidt, S (1998) Linking target costing to ABC at a US automotive supplier, Journal of Cost Management, March/April, p. 19.*

It can be seen that the value index for three components is lower than 1, while the value index for compound component is far above the ideal value. These values show that the costs of three components are high and that the benefit resulting from these components is not at high level.

Functional analysis is applied in the phase of product conception and it is continued in the phase of product design. It helps in the process of product design in accordance with the customers' demands. Moreover, it makes sure that the product costs are not exceeded during the manufacturing phase. Trying to meet the customers' demands and concentrating on key product functions, managers use functional analysis while trying not to exceed the maximum allowable product costs (target cost).

### **ABC with the purpose of achieving the target cost**

After the completion of the functional analysis, managers employed with rotary lip seal manufacturer moved to the second level of implementation of new costing systems with the purpose of realization of cost leadership strategy. The second level was marked by the application of activity-based costing. This was performed with the purpose of identification of the fields marked by the possibility of reducing costs related to this product. Parallel application of functional analysis and ABC enables the determination of the amount of the target cost that can be achieved if some changes related to components and activities are made.

Before applying ABC, managers employed with rotary lip seal manufacturer had to define the target selling price that represents the starting point in determining the enterprise's target profit. The target selling price was at the level of transfer costs at which the product was sold to the partners in the value chain. With the purpose of determining the selling price, managers had to take into account the following: customers, competitors and enterprise's strategic goals (Cokins, 2002). Understanding of the customers' demands regarding the value they expect to get from a product is the starting point for the process of defining the target selling price. It often happens that customers do not want to pay new higher price for a product although they notice the changes related to its design. In that sense, managers have to do their best to design a product and achieve appropriate sales volume at the target selling price. Competitors play an important part in the process of determining the product's target selling price. The situation is such due to the fact that it might happen that more efficient and more available sales on the part of the competitors prevent the attractive target selling price from becoming an adequate tool for achieving competitive advantage. Enterprise's strategic goals, such as winning the additional market share and winning the additional specific categories of customers, have to be taken

## FROM ACTIVITY-BASED COSTING AND TARGET COSTING TO THE REALIZATION OF COST LEADERSHIP STRATEGY

into account in the process of defining the product's target selling price. The target selling price for rotary lip seals that were delivered without packaging was 1,05 \$, whereas the price for seals that were delivered with packaging was 1.22 \$.

With the purpose of efficient implementation of activity-based costing and target costing, rotary lip seal manufacturer focused on two types of costs: the running costs and the target costs (Horvath et al., 1998). Running costs are incurred during the performance of a manufacturing process by using the existent technology. These costs are calculated on the basis of standards for material costs and labour costs, as well as indirect costs by applying the standard overhead cost rate. Before the introduction of activity-based costing, running costs of products used to stand for the basis for the making of strategic decisions within an enterprise. After the application of ABC, running costs of activities became the basis for decision-making processes. The target cost is the goal that should be realized by the improvement of design and optimization of manufacturing process. It stands for the maximum manufacturing cost that could be made without affecting a product's quality and functionality. This cost is calculated on the basis of the product's target selling price. In case of rotary lip seal manufacturer, this cost was calculated on the basis of transfer price at which the seal was delivered to the partners in the value chain. Rotary lip seal manufacturer should tend towards equalization of the running costs of activities and the target cost. Reduction of the gap that exists between these costs represents a goal on which managers employed with this manufacturer are focused with the purpose of realizing cost leadership strategy.

In case of rotary lip seal, running costs of activities were calculated for the seals that were delivered without packaging and for those whose delivery included appropriate packaging. The following formula was used for obtaining the product costs on the basis of activity-based costing:

Sum of all the activities required to produce product + allocated object cost + allocated material cost

Product cost amounts calculated on the basis of activity-based costing, which were obtained by adding of all components, are given in the following table. Amounts shown in the table are expressed in dollars.

**Table 2. Product costs on the basis of ABC**

Product	Sum of all the activities required to produce product	Allocated object cost	The total activity cost	Allocated material cost	Total product cost
	1	2	3 (1+2)	4	5 (3+4)
Seal without packaging	0,28	0,11	0,39	0,16	0,55
Seal with packaging	0,33	0,11	0,45	0,18	0,63

Product costs, calculated by applying the system of activity-based costing, are compared with the target costs. The target costs for seals that were delivered without packaging amounted to 0,32 \$, whereas the target costs for the seals that were delivered with packaging amounted to 0,36 \$. After an in-depth analysis of all these costs, it was established that the product costs had to be reduced by

almost 43%. The target amount of reduced cost of seals delivered without packaging was 0,23 \$, whereas this amount for seals with packaging was 0,27 \$.

After the determination of the target reduced cost, analysis of activities that were performed in an enterprise was carried out, with the purpose of achieving competitive advantage on the basis of costs. The task was to identify activities that consume most resources and classify them into value-added activities and non-value-added activities. There are three activities that are the leading resource consumers: manufacturing, manufacturing support and maintenance, ranked from the highest to the lowest resource consumer. Manufacturing support and maintenance activities were seen as non-value-added activities. Reduction of costs of these activities was possible only on a long-term basis. However, it was not possible to state precisely to which extent the cost reduction could be achieved. Moreover, it could not be predicted whether that reduction would be sufficient for achieving the target cost.

Since this product required great reductions, it was necessary to reset the target cost for this product, all with the purpose of realization of cost leadership strategy. There were two possibilities to reset these costs. The first possibility referred to the potential cost savings by improvement of manufacturing process. Improvement of manufacturing process would require additional significant investments in manufacturing capacities. Moreover, these investments would require the application of new business philosophies such as kaizen, whose results could be seen after a long period of time.

Second possibility was reflected in cost savings within the department of materials procurement. Managers employed with rotary lip seal manufacturer selected this possibility of potential savings due to the fact that it was the only possible option realizable on a short-term basis. Functional analysis, which was previously performed by this manufacturer, was used for these purposes. Functional analysis showed that the costs of components case and spring were high in relation to the benefit they could bring to the customers. This information was important for the managers since they directed all their efforts during negotiations with the suppliers towards reaching lower price of these components. In addition, purposes of cost reduction required the introduction of requirement planning system that enabled tracking of orders per dates of orders and quantity of ordered materials, which facilitated the control of material costs. Efficiency of managers employed with rotary lip seal manufacturer contributed to the increase in value index for physical components of products. Although the value index for these components did not equal the ideal value, it contributed to the reduction of product costs and enabled the enterprise to achieve the target profit.

## **Conclusion**

Reduction of costs under contemporary business conditions is becoming a prerequisite for achieving the leadership position on the market. The situation is such due to the fact that enterprises do their best to become parts of the most efficient value chain. With the purpose of achieving significant competitive advantage, managers select appropriate strategy. Cost leadership strategy advocates price as the main tool for achieving long-term goals of an enterprise. Contemporary business conditions have made managers involve several systems of costing into the process of cost reduction. In this way, it becomes possible to use the advantages of individual systems and absorb the disadvantages of one system by the advantages of another system. In that sense, managers employed with rotary lip seal manufacturer that stands for the part of one of the most efficient value chains in the USA integrated activity-based costing and target costing.

Activity-based costing performs the allocation of costs at two levels. Resource costs are allocated to activities, after which activity costs are allocated to objects of expenditure by using appropriate cost drivers. In addition, application of activity-based costing enables insight into the fact that some resources are not consumed in direct manufacturing and that they are used for

## FROM ACTIVITY-BASED COSTING AND TARGET COSTING TO THE REALIZATION OF COST LEADERSHIP STRATEGY

---

manufacturing activities. Since this system of costing is focused on the manufacturing phase, significant possibilities for cost reduction can be perceived.

As a market-oriented system, target costing recommends certain techniques for cost reduction. This system is used in phases that precede the manufacturing phase. Its efficient realization requires the cooperation of employees from various spheres within an enterprise, as well as partner relations between an enterprise and the suppliers of components necessary for product manufacturing.

Parallel implementation of activity-based costing and target costing results in a conclusion that the possibilities for cost reduction and realization of cost leadership strategy exist on a short-term basis, and that significant results can be achieved if these systems are applied on a long-term basis. Target cost reduction depends on managers' abilities to reduce purchase prices of the components during negotiations with the suppliers which could help them reduce material costs. Significant cost savings on a long-term basis are achieved by improvement of the manufacturing process and application of new business philosophies. Information obtained after the application of activity-based costing, related to non-value-added activities, will also contribute to the improvement of the manufacturing process. Elimination of non-value-added activities from the manufacturing process or efficient realization of these activities will result in the achievement of target cost reduction.

### Acknowledgments

The paper was realized within the scope of the project no. 179066 "Improvement of competitiveness of the public and private sector of Serbia by networking of competences in the process of European integrations of Serbia", funded by the Ministry of Science and Technological Development of the Republic of Serbia

### References

- Antić, Lj., Novičević, B. (2010) Activity-based management – a strategic approach. *Contemporary issues in economics, business and management*. Kragujevac pp. 433 -443.
- Antić, Lj., Novičević, B., (2011) Target Costing for the Purpose of Generic Strategies' Realization, *Facta Universitatis Series „Economics and Organization“*, No. 3, Vol. 8, strp. 247-261.
- Brausgh, J. (1994) Beyond ABC: Target Costing for Profit Enhancement. *Strategic Finance*, 76, 45- 49.
- Cokins, G. ( 2002) Integrating target costing and ABC, *Journal of Cost Management*, jul/august
- Horvath, P., Gleich, R. Schmidt, S (1998) Linking target costing to ABC at a US automotive supplier, *Journal of Cost Management*, March/April
- Kaplan, R. and Cooper, R., *Cost & Effect – Using Integrated Cost Systems to Drive Profitability and Performance*, Harvard Business School Press, Boston Massachusetts, 1998.
- Malinić, S. and Jovanović, D. (2011) Implementacija integrisanih koncepata upravljanja troškovima u lancu nabavke – strategijski pristup TC i ABC. *Računovodstvo*. 36, 29-44.
- Weygandt, J, Kimmel, P., Kieso D. (2008) *Managerial Accounting*. New Jersey: John Wiley & Sons.

# FOREIGN CURRENCY TRANSLATION – KEY ISSUE IN INTERNATIONAL ACCOUNTING

Ljiljana Dmitrović Šaponja<sup>1</sup>

Jasmina Bogićević<sup>2</sup>

**Abstract:** *Foreign currency translation represents the most important international accounting aspect, especially in the context of the consolidation, segment reporting and foreign currency hedging. The significance of foreign currency translation had been recognized relatively recently with the expansion of international business activities and the increasing exchange rates volatility.*

*Foreign currency translation refers to the process of restating accounting data expressed in one national currency into another, for the purposes of aggregating data from different reporting entities.*

*The key issues are concerned with which exchange rate to use to translate the foreign currency transactions and foreign operation financial statements and how to treat translation effects. There is a variety of practical approaches, and much controversy appeared concerning the major alternative methods for foreign currency financial statement translation, i.e. temporal method and current rate method. Alternative translation methods give rise to different magnitude, sign and financial reporting disposition of translation effects.*

**Keywords:** *foreign currency transaction, foreign currency financial statement, temporal method, current rate method.*

## Introduction

International accounting, encompassing enormous amount of geographically and topically territory, represents the integral part of the global economic scene. An understanding of its dimensions is crucial for those whose operating, investing and financing activities transcend their national boundaries. Hence an international accounting knowledge is necessary asset in the portfolio of skills required of managers and executives engaged in global business.

There are a number of international accounting issues which relate to problems that are either unique to international business or have an international dimension. Major issues include group accounting and consolidations, segment reporting, inflationary accounting and foreign currency translation.

Foreign currency translation refers to the process of restating accounting data recorded in one currency into another for the purposes of their accounting treatment. A unique international accounting issue of major importance in the context of consolidation accounting, inflation accounting, segment reporting and foreign currency hedging is the translation of accounting data denominated in foreign currencies. The emphasized importance of foreign currency translation requires its definition and essential consideration, highlighting of its role in other areas of international accounting, as well as analysis of its key accounting aspects.

---

<sup>1</sup> Faculty of Economics Subotica, University of Novi Sad

<sup>2</sup> Faculty of Economics, University of Kragujevac, jasminabogic@ptt.rs

### International accounting dimensions

The turning point from twenty to twenty one century designated a period in which the operation, financing and investing decisions are imbued by the international implications. As the great number of these decisions are made on the base of relevant and reliable accounting information, originate from different countries, it could be ascertained that international accounting knowledge is a critical assumption for international business communications interpretation, understanding and maintaining. No wonder that growing importance and dynamic development of international accounting timely coincide with the business environment globalization and accounting profession internalization.

At the beginning of a new century accounting is a creative mixture of the old and the new. Although doubly-entry bookkeeping is more than 500 years old it still forms the corner-stone of the accounting architecture. Modern accounting is not the invention of one country, but a great number of countries contributed its development. Accounting has never been purely national phenomenon, it has always been international. Hence leading authors in this field ascertained that accounting heritage is undoubtedly international and that actual concern with international accounting is more renaissance than a new idea.

However, the rise of global economy, the multinational companies (MNCs), the integration of capital markets and the increased cosmopolitanism of investors suggest that there is a new type of information seeker – international information seeker. The requirements of these international information seekers take new and distinctive accounting field. That specific subdiscipline is international accounting (Belkaoui, 1999).

Although this accounting field has significantly developed in the last five decades, there is no single one definition of international accounting in the wide range of literature published on the theme. Instead of one universally accepted international definition, several various definitions of this specific accounting subdiscipline co-exist. This diversity could be explained having in mind the intention of each author to emphasize in its suggested version of definition some key international accounting dimension. Having studied textbooks of outstanding experts in international accounting it could be noted that just a few authors did state a precise definition of international accounting. Some authors consider that international accounting as such, specific area does not exist, but is mixture of financial accounting and managerial accounting in international context. As it is not feasible to consider the integral definition spectrum, we are going to present sufficiently illustrative definitions on the basis of which it is possible to perceive not only international accounting essence, the significance of its study, but its major issues, too.

*Lawrence, author of International Accounting book*, offers very simple and short definition that international accounting involves the study of accounting on a global rather than national scale. This concise definition concentrates on the two key words „international“ and „accounting“. He interpretes the former as concerning or involving two or more nations or nationalities and the latter as the process of recording, analysing and reporting financial information so as to maximize the value of information produced. Thus international accounting designates the process of providing useful information viewed on multinational basis (Lawrence, 1997). Choi and Mueller give their own definition which is worth quoting here. They point out that the study of international accounting should be based on properly definition and having considered several alternatives they decided on the following definition which extends nationally oriented accounting and in its broadest sense it relates to (1) international comparative analysis, (2) accounting measurement and reporting issues unique to multinational business transactions and the business form of the multinational enterprise, (3) accounting needs of international financial markets, and (4) harmonization of world accounting (Choi and Mueller, 2008). According to his opinion the study of international accounting should include: consideration of accounting principles and practices of several nations, rather than the usual one-nation emphasis of

more traditional accounting, a comparison of those principles and practices, a review of technical accounting problems that affect all nations in general and a specific review of some of the problems, both technical and reporting, that arise because of differences between nations, e.g. the existence of different national currencies. In other words *differentia specific* of international accounting is dealing with multinational companies, foreign activities and transactions, as well as accounting information users out of the reporting entity country.

International accounting could be defined having in mind its three conceptual approaches: (a) universal (world) accounting, (b) comparative accounting and (c) accounting for foreign subsidiary.

The *concept of world accounting* is based on single set of universally accepted accounting principles that could be adopted in all countries and contributed the unification of accounting practices in the world. Despite the process of global accounting harmonization/convergence, existing national accounting differences, caused by many environmental factors, make impediment the achieving of this goal. Having in mind that a complete accounting standardization of accounting principles internationally as its aim is unlikely to be achieved in the near future, this concept represents pure theoretical, idealistic construction. This pessimistic attitude is a reflection of the many obstacles to a complete standardization of accounting. In other words many factors determine accounting differences internationally. The *concept of comparative accounting* includes all varieties of national accounting standards established for each country. It involves understanding of national differences in accounting practices and the assessment of their impact on financial reporting. These differences result because of different national environmental factors which influence on national accounting development. As these factors shape and reinforce accounting characteristics unique to each national environment this concept may be characterized as realistic one. The *concept of accounting for foreign subsidiaries* includes consolidating the financial statements of the parent company and its subsidiary and foreign currency translation.

It is evident that international accounting, as a well established field within accounting, involves two major areas:

1. descriptive/comparative accounting
2. pragmatic accounting dimensions of international transactions/MN companies

The first area concerns comparison of national accounting practice in different countries and is oriented on the examination how and why national accounting principles differ. It also includes classification of accounting systems. On the other hand, the second area covers foreign currency translation, segment reporting and consolidation accounting, i.e. issues and technical problems encountered by firms in international business.

Illustrative and detail conceptual and essential determination of international accounting makes possible understanding its major issues.

### **Major international accounting issues**

There are a number of international accounting issues which relate to the problems that are either unique to international business or have an international dimension. Major issues include group accounting and consolidations, segment reporting, inflationary accounting and foreign currency translation. The latter represents the most important international accounting aspect, especially in the context of consolidation and segment reporting. The most common use of foreign currency translation is the presentation of consolidated financial statement of multinational group, but translation is required in many other cases. In order to understand the key role of foreign currency translation in international accounting it is necessary to define this accounting syntagm. In other words it is crucial

## **FOREIGN CURRENCY TRANSLATION – KEY ISSUE IN INTERNATIONAL ACCOUNTING**

---

to highlight the accounting meaning of foreign currency translation as a process whereby financial data expressed in terms of one currency is restated in terms of another (Nobes and Parker, 2008). Accountants make distinction between foreign currency conversion and foreign currency translation. While the foreign currency conversion is actually changed from one currency to another, translation means the change of monetary expression of unchanged asset.

In an international context issues relating to inflation accounting, consolidation accounting, segment reporting, and foreign currency translation are related. It should be decided whether foreign subsidiaries' financial statements should be inflation adjusted before or after their translation. Financial statements of foreign subsidiaries need to be restated in terms of the currency of the parent company before their consolidation. One way to obtain relevant geographic segment information in international setting is to take into consideration the effects of volatility exchange rate. It is also possible to consider the issue of foreign currency translation in the context of global accounting harmonization, too.

No wonder that consolidated financial statements were first mentioned and appeared in USA. It could be explained by the earlier development of the holding company there. American companies first adopted and published consolidated financial statements at the beginning of the twenty century. While accounting consolidation has long been a common practice in countries such as the United States, the United Kingdom and the Netherlands, it is relatively recent phenomenon in many other countries. Consolidated financial statements became general in the United Kingdom after the Companies Act 1948. The practice of consolidation moved much slowly in other European countries. Companies in continental Europe started to consolidate financial statements later. Consolidation accounting is fairly recent requirement in Japan.

As consolidation becomes more widespread and as the globalization of business, financial and investment activities increases, the issue of foreign currency translation can be expected to become more important issue. There is no worldwide adopted practice in the field of consolidation accounting. There are still differences in the rate of adoption of consolidated financial statements, relevant concept of a group for consolidation purposes, as well as techniques of consolidation. Major problem is how to resolve the continental European approach to define group, which emphasizes the effective management control, with the Anglo-American approach, based on the legal power to control another company. Furthermore, there are considerable differences among countries in terms of whether or when to use full, proportionally or equity methods of consolidation. Additional major differences relate the consolidation of foreign subsidiaries and the treatment of goodwill. Attempting the harmonization The International Accounting Standard Board (IASB) and EU have had effects on the consolidation in two ways: indirectly, on the negotiations for EU's seventh Directive and directly on the practices of companies in those countries where International Accounting Standards (IASS) and International Financial Reporting Standards (IFRSs) are in general use.

At the level of MN companies the issues relating consolidation and foreign currency translation are related. Foreign subsidiaries' financial statements should be translated before their consolidation with parent's company financial statements. There are three overall stages in multinational financial statements consolidation: (1) transaction translation, (2) financial statement translation, and (3) consolidation of translated financial statements. Three stages in preparing consolidated financial statements for multinational groups are shown in Table 1.



**Table 1 – Stages of preparing consolidated financial statements for multinationals**

<i>Stage</i>	<i>Description</i>	<i>Consequence</i>
<b>1. Transactions</b>	Foreign currency transactions translated by each group member in own statements	Each group member's financial statements are expressed in their own (foreign) currency
<b>2. Translation</b>	Each group member's financial statements translated into group reporting currency	All foreign financial statements expressed in group reporting currency
<b>3. Consolidation</b>	All translated statements consolidated	Consolidated financial statements in group reporting currency

*Source: Walton et al., 2003, p. 407.*

It could be simple explained by citing an example where a French parent holds a controlling stake in Danish and other subsidiaries. The Danish subsidiary trades in the USA, Japan and the United Kingdom. Hence, the Danish subsidiary has to translate its foreign currency transactions (dollar, yen and sterling denominated transactions) into kronor (stage 1). Then the kronor financial statements are translated into the reporting currency, euros (stage 2). These euro denominated financial statements are consolidated with the euro financial statements of the parent and other subsidiaries to produce euro consolidated statements in reporting currency (stage 3).

The counterpoint to financial statements consolidation is segment reporting. Segment reporting provides information on a disaggregated basis for each of the segments. In recent years there has been an increasing interest in provision of additional information, including disaggregated or segment information. Although the users of accounts need consolidated financial statements, they are aware of the relevance of disaggregated information. In other words aggregated financial statements as economic summary do not provide all the relevant information that users need. As companies have ventured into new lines of business (industries) and new geographical areas the usefulness of aggregated information decreased without additional detailed information. In order to gain a better understanding of the importance of foreign affiliated entities, analysts use the consolidated equity and net income number, but prefer segment information. As the international activities of firm have grown accounting information users have preferred information disaggregated by geographic segments. The disclosure of international activities of MNCs by their geographic areas makes possible better understanding the results of individual segment and the result of a MNC as a whole. The principal objective of segment information is to enable users of financial statements to make a better analysis of a reporting entity past performance. Segmentation by industry and geographical areas is highly relevant to an analysis of a reporting entity profit prospects and risk exposure when making business decisions. Different lines of business and different geographic areas have a variety of profit potentials, growth opportunities, types and degree of risk. Different rates of return on investment, different capital needs exists throughout the different segment of business. Because of the diversification of foreign operations MNCs report key disaggregated information, especially profits and turnover. Such segment information is provided for both foreign subsidiaries and lines of business. By extending financial statements to include information about activities in different industries and foreign locations, improved assessment can be made regarding the MNC as a whole. With the growth of multinational companies consolidated financial statements become more highly aggregated and the presentation of segmented information as an integral part of financial statements becomes more necessary to provide

## **FOREIGN CURRENCY TRANSLATION – KEY ISSUE IN INTERNATIONAL ACCOUNTING**

---

useful information for economic decisions. But segmentation of an entity into different components of business activities is not exclusively phenomenon of groups but can occur within single legal entities. At the level of MNC segment reporting is directly related to the foreign currency translation. When the parent company use segment information for evaluation of foreign entities' past performance disaggregated data should be translated and denominated in national currency of parent company.

Although the inflation is worldwide phenomenon the practice of reporting its impact is not at all widespread. Comparative studies have shown that the rate of adoption inflation accounting is directly related to the rate of inflation. Accounting model based on historical cost, which dominates financial reporting practice in most countries, ignores the effects of inflation on financial statements. Inflation can significantly distort the information content of historical cost financial statements. It has an adverse effect on decisions usefulness of financial statements not only in domestic environment, but in international setting, too. It is very difficult to compare accounting numbers from countries with different rates of inflation. The general price level adjusted model and the current cost-adjusted accounting are main inflation-adjusted accounting approaches used as a tool in gauging inflationary effects on financial statements. In an international context it is not possible to separate the issue of foreign currency translation from the issue of accounting for foreign inflation. It has to decide whether foreign subsidiaries' financial statement should inflation adjusted before or after their translation. In other words, it should take into consideration different effects from different approaches, i.e. restate/translate or translate/restate process.

The emphasized key role of foreign currency translation and its relations with other international accounting issues confirm the necessity of the separately consideration its pragmatic aspects.

### **Pragmatic Aspects of Foreign Currency Translation**

Foreign currency accounting, including foreign currency translation and foreign currency hedging, has a particular relevance in global arena. Foreign currency translation as a key international accounting issue may be treated from a comparative point of view, covering practices in several countries, as well as a pragmatic accounting dimension of international transactions and operational problems encountered by multinational companies. In a pragmatic context it is one of the most vexing, complicate and controversial technical issue.

No wonder that growing importance and dynamic development of foreign currency translation timely coincide with the business environment globalization and exchange rates fluctuations. The specific role of this international accounting area could be explained by the fact that foreign currency translation makes possible presentation of MNC consolidated financial statements. Besides aforementioned its most common use, it is required in many other cases, such as recording foreign currency transactions, reporting international branch and subsidiaries activities, and reporting the results of the independent operations abroad (Choi and Meek, 2008).

There are two basic pragmatic aspects of foreign currency translation:

1. The translation of foreign currency transactions
2. The translation of foreign currency financial statements of branches, subsidiaries and other investees that are incorporated in the financial statements of an entity by consolidation.

International transaction should be differentiated from foreign currency transaction. Only one party to international transaction has a foreign currency transaction because settlement is stipulated in only one currency. The party that must receive or make payment in other than its own national currency is confronted with foreign currency transaction. For example, a domestic exporter who

receives payment in the customer's currency and/or domestic importer who pays for goods and services in the supplier's currency have foreign currency transaction, whereas the customer and the supplier have only international (foreign) transaction. Hence a foreign currency transaction is defined as international economic activity denominated in a foreign currency. It requires settlement in a foreign currency. These international economic activities denominated in a foreign currency include the following:

1. import purchasing or export selling on credit goods and services when prices are denominated in foreign currencies
2. borrowing or lending funds when repayment is to be made in a foreign currency
3. unperformed foreign currency forward contracts
4. other reasons when entity acquires or disposes assets or incurs or settles liabilities denominated in foreign currency.

Today foreign currency sales, purchases, borrowing or lending transactions are regular occurrence. Collections from export sales or payments for imported items may not be in national, but in foreign currencies. Thus a company purchasing inventory or selling the goods on credit may suffer a transaction loss whenever the exchange rate changes between the transaction and settlement dates. The volatility of exchange rates has a direct effect on company cash flows and profitability.

Growing of import activities in the Serbia and depreciation of domestic currency against foreign currencies has increasingly accentuated the importance of accounting for foreign currency transactions for firms. Often purchases and sales between Serbian company and foreign company are credit transactions, calling a payment at a later date. If the denominated currency is other than Serbian dinar, a Serbian firm translates the foreign currency to dinars before initially recording the foreign currency transaction. The currency exchange rate used in translation is the one that exists on the date the transaction takes place. Foreign currency amounts are translated by dividing by indirect quotes or by multiplying by direct quotes. Accountants generally agree that a foreign currency transaction should be recorded initially in the reporting currency at the transaction date using the exchange rate in effect at that date. If credit terms are granted or used the next accounting issues arise: if the exchange rate changes between the transaction date and intervening balance sheet date should the foreign currency receivable or foreign currency payable pertaining to the unsettled part of transaction be adjusted and how should the difference between amount at the settlement transaction date and amount initially recorded be treated. If the foreign currency exchange rate has fluctuated from the transaction date to balance sheet date, an adjusted entry is required in order to calculate and record unrealized transaction gains or losses. Realized transaction gain/or loss should be differentiated from unrealized one. Realized gain or loss can be easily quantified and measured at each moment. On the other hand, there is no possibility to exactly quantify and measure the all unrealized transaction loss or gain. It is possible to quantify unsettled gain or loss on (unsettled) foreign currency transaction whenever financial statements are prepared.

As it has mentioned companies may have foreign currency borrowings and/or foreign currency loans. When companies borrow foreign currency from foreign lenders they are faced with the facts that the principal and interest are denominated in foreign currency and both of them create liability exposure. When companies lend foreign currency they have both the principle and interest denominated in foreign currency.

The translation of foreign currency financial statements of branches and subsidiaries represents the other pragmatic aspect of foreign currency translation. The problem of translation of financial statements arises when a parent company has foreign subsidiary that operates abroad. Foreign subsidiary records all of its own day to day transactions and prepares its own financial statements in its

## **FOREIGN CURRENCY TRANSLATION – KEY ISSUE IN INTERNATIONAL ACCOUNTING**

---

own country's currency. In order for the parent company to prepare consolidated financial statements of multinational group as a whole, amounts contained in foreign subsidiary's financial statements are translated to parent company's home currency using one of the four major translation models: (1) the current-noncurrent method, (2) monetary-nonmonetary method, (3) temporal method and (4) the current rate method. The major differences among these methods pertain mainly on which rate to use to the translation of the balance sheet amounts and a few items of income statement. Hence the key issues are concerned with which exchange rate to use to translate the financial statements (current rate, historical rate or weighted-average rate) and how to treat translation effects (accumulate in separate component of stockholder's equity or report currently in the income statement). There are a variety of practical approaches and much controversy appeared concerning the financial reporting treatment of translation effects. Balance sheet items translation is based on current and/or historic rate. For translating income statement items it is generally used the weighted-average rate for a particular accounting period. The exception to this rule relates to only two items of income statement, such as the cost of goods sold and the depreciation expense. Since the historical rate, the current rate and the weighted average rate are used in financial statements translation debits and credits will no longer be equal after foreign currency items restatement. This difference may be alternatively reported as the translation adjustment in the equity section of balance sheet or as a translation gain or loss in the income statement. It depends on the selected translation model.

The current–noncurrent method is based on a traditional accounting scheme for the balance sheet. This method is where the foreign subsidiary's balance sheet items classified as current are translated from foreign currency to parent company's reporting currency at the current rate and which uses historical rates for the translation of noncurrent assets and liabilities. Except depreciation and amortization expenses which are translated at historical rates, the other income statement items are translated at average rate for the whole reported period. Many consider that this method based on accounting classification according to maturity makes little economic sense. Although this method makes possible creditors the assessing a firm's liquidity, it has no theoretical or conceptual support. While current-noncurrent method is based on the translation of accounts according to their maturity, the essence of monetary-nonmonetary method is their translation according to their nature. According to this method monetary assets and liabilities are translated at the current rate, and nonmonetary assets and liabilities and stockholders' equity are translated at historical rate. Under the temporal method, as shown in Table 2 cash, receivables and payables (current and noncurrent) are translated at the current rate. The translation of other assets and liabilities depends on their measurement bases: accounts carried at historical cost are translated at historical rates, those one carried at current prices are translated at current rates. The current rate model is the simplest because it requires as its name implies that all assets and liabilities are translated at the current rate. Main differences among the four translation models for balance sheet and income statement items are shown in Table 2.

The different translation methods give rise a wide range of results with different magnitude and sign. It has to be in mind that these different results are identified on the same facts. Furthermore, some subsidiaries reporting profit before foreign currency translation may report reduced profit or loss after the translation and conversely.

**Table 2 – Methods of foreign currency financial statements translation**

FINANCIAL STATEMENT ITEMS	TRANSLATION METHODS			
	Current-noncurrent	Monetary-nonmonetary	Temporal	Current rate
<i>Balance sheet items</i>	Translation rate used			
Cash	Current	Current	Current	Current
Current receivables	Current	Current	Current	Current
Inventories	Current	Historic	Historic	Current
Fixed assets	Historic	Historic	Historic	Current
Current payables	Current	Current	Current	Current
Long-term debt	Historic	Current	Current	Current
<i>Income statement items</i>				
Cost of goods sold	Current	Historic	Historic	Current or Average
Depreciation expense	Historic	Historic	Historic	Current or Average

**Conclusions**

The growing importance of international accounting could be associated with the dynamic processes in international economic relations, as well as the changes at the enterprise level. From macro aspect, it is evident that the countries' perspective and their effective including in international economic flows mostly depend on their attitudes toward international accounting. Hence it could be ascertained that the need for separation and affirmation of this dynamic accounting field is the result of global economic-financial reality with which the world confronts.

A wide range of literature published in international accounting sphere confirms the significant development of this accounting field in the last five decades. However, although there are many publications in which the internationalization of accounting has been considered, international accounting has no agreed definition. Furthermore, several versions of its precise definition co-exist in only few of them.

The growing significance of foreign currency translation and the problems surrounding it would appear to have been recognized relatively recently with the expansion of international business activities and the increasing volatility of exchange rates. This specific area within international accounting has the effect on other areas such as consolidation, segment reporting and inflation accounting and is highly interrelated with foreign currency hedging. In an international context issues relating to inflation accounting, consolidation accounting, segment reporting, and foreign currency translation are related. It should be decided whether foreign subsidiaries' financial statements should be inflation adjusted before or after their translation. Financial statements of foreign subsidiaries need to be restated in terms of the currency of the parent company before their consolidation. One way to

## **FOREIGN CURRENCY TRANSLATION – KEY ISSUE IN INTERNATIONAL ACCOUNTING**

---

obtain relevant geographic segment information in international setting is to take into consideration the effects of volatility exchange rate.

The translation of foreign currency transactions and the translation of foreign currency financial statements of branches, subsidiaries are two basic pragmatic aspects of foreign currency translation. A foreign currency transaction results when a company engages in business with a company from another country, which uses a different currency. Foreign currency transactions require settlement in a foreign currency. Today foreign currency sales, purchases, borrowing or lending funds transactions are regular occurrence. Thus a subsidiary selling the goods or purchasing inventory on credit may suffer a foreign exchange (transaction) loss or gain whenever the exchange rate changes between the transaction and settlement dates. Collections from export sales or payments for imports are not always made in a subsidiary local currency. It depends on negotiated terms. In order for the parent company to prepare consolidated financial statements of multinational group as a whole, amounts contained in foreign subsidiary's financial statements are translated to parent company's home currency using one of the four major translation models: (1) the current-noncurrent method, (2) monetary-nonmonetary method, (3) temporal method and (4) the current rate method. The major differences among these methods pertain mainly on which rate to use to the translation of the balance sheet amounts and a few items of income statement. Different translation methods give rise to different magnitude, sign and financial reporting disposition of translation effects.

### **References**

- Belkaoui, A. (1999). *International & Multinational Accounting*. London: The Dryden Press.
- Choi, F.D.S. and G.K. Meek (2008). *International Accounting*, Sixth Edition. New Jersey: Pearson Education International.
- Choi, F.D.S. and J. Czechovicz (1996). Assessing Foreign Subsidiary Performance: A Multinational Comparison. In: *Readings in International Accounting* (J. Blake and M. Hossain, eds.). London: International Thomson Business Press, pp. 274-288.
- Doupnik, T. and H. Perera (2007). *International Accounting*, International Edition. New York: McGraw-Hill.
- Lawrence, S. (1997). *International Accounting*. London: International Thomson Business Press.
- Nobes, C. and R. Parker (2008). *Comparative International Accounting*. Harlow: Pearson Education Limited.
- Roberts, C. *et al.* (2008). *International Corporate Reporting: A Comparative Approach*. Harlow: Pearson Education Limited.
- Saudagaran, S.M. (2009). *International Accounting: A User Perspective*. Chicago: CCH.
- Taylor, P.A. (2003). Foreign Currency Translation. In: *International Accounting* (P. Walton *et al.*, eds.). London: Thomson Business Press.

# THE IMPACT OF FOREIGN CURRENCY TRANSLATION ON FOREIGN SUBSIDIARY PERFORMANCE

Jasmina Bogićević<sup>1</sup>

Violeta Domanović<sup>2</sup>

Slavica Manić<sup>3</sup>

**Abstract:** *Performance evaluation of subsidiaries located in other countries and their managers assumes a simultaneously application of financial and non-financial measures. Financial criteria tend to dominate performance evaluation systems. Setting up an effective performance evaluation system for foreign subsidiaries is based on their financial statements which are expressed in different currencies. Hence, it requires decisions with regard to selection of foreign subsidiary's financial statements translation method in order to express them in a single one currency. The use of different translation methods can have significant influence on the key financial statements' items and hence on key financial measures of foreign subsidiary performance. A potential problem for foreign subsidiary performance assessment in this regard is the possibility that foreign currency financial statements translation effect could be alternatively included in profit or in owner's equity. In other words it could be expressed in balance sheet as well as in income statement.*

**Keywords:** *foreign currency translation, assessing foreign subsidiary performance, foreign currency financial statement, translation effects.*

## Introduction

Performance evaluation of foreign subsidiaries and their managers must deal with some issues that are unique to global business, such as exchange rate volatility, varying rates of inflation in foreign countries, international transfer pricing and environmental differences that exist across countries. These factors must be considered appropriately, otherwise headquarters may have a completely erroneous idea about foreign operating results and use inappropriate standards to assess foreign subsidiary performance. Inappropriate standards may induce their managers to take measures not in line with corporate goals.

The foreign subsidiary performance evaluation assumes an integral information basis, i.e. simultaneously application of financial and non-financial measures. Both financial and non-financial criteria are used for the evaluation of the performance of overseas unit and its manager. Financial criteria tend to dominate performance evaluation systems. Highly interrelated foreign subsidiary's financial statements provide users with a more reliable set of data and enable the identification of the key subsidiary performance financial measures.

Correspondingly, setting up an effective performance evaluation system for subsidiaries located in other countries are based on their financial statements which are expressed in different currencies.

---

<sup>1</sup> Faculty of Economics of the University of Kragujevac, jasminabogic@ptt.rs

<sup>2</sup> Faculty of Economics of the University of Kragujevac

<sup>3</sup> Faculty of Economics of the University of Belgrade

## **THE IMPACT OF FOREIGN CURRENCY TRANSLATION ON FOREIGN SUBSIDIARY PERFORMANCE**

---

Hence, it requires decisions with regard to selection of foreign subsidiary's financial statements translation method in order to express them in a single one currency.

To gain a complete picture of how the selection of foreign currency financial statement translation method impacts subsidiary performance evaluation we must take into consideration decision on the appropriate exchange rate to be used in translation, as well as the decision where to show translation effects in financial statements. A potential problem for foreign subsidiary performance assessment in this regard is the possibility that foreign currency financial statements translation effect could be alternatively included in profit or in owner's equity. Saying by other words it could be expressed in balance sheet as well as in income statement.

The first issue related to the translation of foreign subsidiary financial statements is the selection of the appropriate method. The four methods of foreign currency translation are the current rate method, the current/non-current method, the monetary/non-monetary method, and the temporal method. Multinational companies (MNCs) should consider which of these methods best reflects economic reality for the particular foreign subsidiary being evaluated. It is very important to consider if translation effects are involved into result or equity. If translation effect represents a part of the result, it should be encompassed in performance evaluation. On the other hand, translation adjustment as a result of foreign currency financial statements translation should not be always included into performance evaluation. The use of different translation methods can have significant influence on the key financial statements' items and hence on key financial measures of foreign subsidiary performance. Different translation methods do give rise to translation effects of differing sign and magnitude.

The main point of this paper is how to treat translation effects of foreign subsidiary's financial statements in assessing its performance. Thus, the paper is structured in three parts. The first part is devoted to the importance of simultaneously application of financial and non-financial measures in foreign subsidiary performance evaluation. Accounting aspects of foreign currency translation are considered in the second part. The third part relates to the impact of foreign currency financial statements translation methods on subsidiary performance.

### **Assesing foreign subsidiary performance**

Many MNCs establish new foreign subsidiaries in order to penetrate foreign markets, diversify business risk and maximize long-term profits. A complex issue of enterprise performance evaluation becomes much more complex in an international context. Performance evaluation of foreign subsidiaries must deal with some issues that are peculiar to international business, such as exchange rate volatility, varying rates of inflation in foreign countries, international transfer pricing and environmental differences that exist across countries. Unless these factors are appropriate considered headquarters risks receiving distorted pictures of foreign operating results and use inappropriate standards to assess performance. Distorted picture of results leads to presenting misleading and imperfect financial measures of performance. Inappropriate standards of foreign subsidiary performance may encourage overseas managers to take action not in line with corporate goals. Direct consequence is reduced efficiency of foreign subsidiary and its manger, as well as a MNC as a whole. (Choi and Meek, 2008)

The performance evaluation system does play a significant role in evaluating not only foreign subsidiaries, but foreign managers. In assessing performance of foreign subsidiary and its mangers it is very important to evaluate their contribution to the performance of the MNC as a whole. Performance evaluation of foreign subsidiaries must be in line with the overall corporate strategies and the local circumstances. The success of performance evaluation system is determined by its design and its



implementation. Developing a properly designed and effective performance evaluation system for foreign subsidiaries and their managers requires decisions with regard to:

1. The performance criteria selection;
2. Distinguishing between subsidiary performance and manager performance;
3. Understanding some issues specific to companies engaged in global business, such the choice of appropriate currency for performance evaluation, transfer pricing policies, differing levels of inflation and political stability across countries.

***The performance criteria selection***

No single criterion is capable of capturing all factors of foreign subsidiary and its management performance. Hence MNCs must decide to use financial criteria, non-financial criteria, or some combination of the two to evaluate foreign subsidiary's performance. Although both financial and non-financial measures are used for the evaluation of the performance of overseas unit and subsidiary manager, financial measures, based on information obtained directly from financial statements, tend to dominate performance evaluation systems. They include sales volume and growth, cost reduction, profit, comparing actual results with expected results, and return on investment (ROI). Several studies have found national similarities and differences with respect to the prominence given to financial measures in evaluating foreign subsidiary and its management performance. Most widely financial performance measures used by both U.S.-based MNCs and U.K.-based MNCs for evaluating their foreign subsidiaries are profit, return on investment and budget compared to actual profit (reported in Table 1) Although the rank order changes slightly those MNCs have consistently used these three measures. ( Doupnik and Perera, 2007) By contrast, the frequently used measures by Japanese MNCs are sales volume and production cost.

**Table1- Financial Measures Used by U.S. and UK MNCs to evaluate Subsidiary Performance**

Financial Measures	Ranking			
	United States		United Kingdom	
	1980	1984	1990	1998
Profit	1	2	1	3
Return on investment (ROI)	2	3	3	2
Budget compared to actual profits	3	1	2	1

*Sources: Doupnik, T, Perera H. (2007): International Accounting, International Edition, McGraw – Hill Companies, New York, p. 541*

Some authors consider that ROI measure may be more appropriate for measuring unit, subsidiary performance while budget comparisons may be more useful in evaluating managers. (Choi et al, 1999). Profit represents not only individual (separate) measure, but is used in identifying ROI and budgeted measures. The major advantage of profit as a measure of performance is that it embodies all the major business functions from marketing /sales revenue/, to production /cost of goods sold/ to financing /interest rate/. (Doupnik and Perera, 2007) In other words profit is synthesized term. As ROI relates income to a specified investment base, its variations depend on the selection of appropriate elements of income and the investment base. Income components used for managerial evaluations should only include those revenues and expenses that managers can control. The denominator of the

## **THE IMPACT OF FOREIGN CURRENCY TRANSLATION ON FOREIGN SUBSIDIARY PERFORMANCE**

---

ROI measure may be shareholders' equity, shareholders' equity plus total interest-bearing debt or total assets. For performance evaluation of management, investment base should include the resources it can control. Likewise, for the subsidiary performance evaluation the investment base should consist all capital employed in accomplishing its objectives.

Financial measures should be supplemented as much as possible with non-financial measures of performance. A balanced scorecard combines historical, less predictive financial measures with four nonfinancial perspectives. Despite difficulties in measurement, some non-financial criteria are considered important in foreign subsidiary and its management performance evaluation system. Non-financial criteria reinforce financial measure and highlight the difference between managerial and unit performance. Important non-financial measures of performance involve: market share, customer satisfaction (retention), relation with host country government, quality control, environment compliance, employee development and safety, research and development in foreign unit and productivity improvement. As nonfinancial measures are subjective as compared with their financial counterparts they are not meant to replace, but to enhance the value of traditional quantifiable and objective financial measures.

The Balanced Scorecard (BSC) is the strategic management and management accounting model developed by the Professor Dr. Robert Kaplan from Harvard Business School and Dr. David P. Norton in the early 1990s. It first appeared in the article 'The Balanced Scorecard – Measures that Drive Performance' in the Harvard Business Review in 1992 (see Kaplan and Norton, 1992). Since then, these creators developed its conceptual and practical characteristics in a series of books (1996a, 2000), and articles (1993, 1996b, 2001, 2004). Their text entitled *The Balanced Scorecard* (Kaplan and Norton, 1996a) provides their most their most comprehensive exposition. In a subsequent book they illustrated, through a series of case studies, how a number of companies have actually implemented the BSC and how it can be integrated with strategy maps. Researchers have subsequently reported on the diversity of performance measurement systems labelled BSCs (e.g. Butler et al., 1997; Mooraj et al., 1999; Ahn, 2001).

The Balanced Scorecard removes some of the weaknesses and disadvantages of previous performance measurement and management models. It attempts to provide a clear prescription as to what organisations should measure. It also translates vision and strategy, defines the strategic linkages to integrating performance across an organisation, communicates objectives and measures to a business unit, and aligns strategic initiatives. When fully implemented, it aligns employees in the organisation so that they understand how and what they can do to support the strategy. Also, the BSC can be used as a basis for compensation and provides feedback to management as to whether the strategy is working or not. The Balanced Scorecard implies that an organisation's performance can be viewed from four main perspectives: financial, customer, internal business process, and learning and growth. These four perspectives are linked to the organisation's strategy and create a holistic model of its strategy that allows all employees to see how they can contribute to the success of the organisation. Some variation to and within this BSC model is possible. Kaplan and Norton recognise that sometimes the nature of corporate vision and strategy may require further perspectives (Kaplan and Norton, 1996a, p. 34). For instance, alternative perspectives focusing on organisational problems and human elements have been suggested by Olve et al. (1997) and Maisel (1992), respectively. Within the suggested framework, the selected measures representing the each perspective may differ across organisations.

In literature, there could be found the following benefits of the BSC implementation: the clarity of focus which it brings to the critical factors determining performance (Kanji and Sa, 2002; Ritter, 2003); its value as an information system for diagnosis and control (Pandey, 2005); its contribution to the effectiveness of strategy implementation through the translation and communication of strategy in the form of tangible measures (Brabazon, 1999; Kanji and Sa, 2002); its use as a substitute for traditional budgeting (Ax and Bjørenak, 2005); and its flexibility and fit to different organisations

(Kanji and Sa, 2002). However, research has also shown that BSC users are not very knowledgeable about the cause and effect relationships that should govern the selection of performance measures. In practice, users simply have a belief in the relationship between measures rather than testing and identifying the nature of actual relationships. Implementations have met a series of practical problems (Ahn, 2001). Organisations have focused on building an operational tool that apparently works at a technical level, rather than following the conceptual blueprint of Kaplan and Norton. As with many novel developments linked to control and remuneration, resistance to change has been apparent. Kasurinen (2002), for example, found that three different types of barriers to BSC implementation exist, which he terms 'confusers' (uncertainty about the role for the BSC), 'frustrators' (the existence of an antagonistic engineering culture), and 'delayers' (difficulty in specifying strategies). Consequently, the process of implementation requires careful attention if the BSC is to be adopted successfully. This view is confirmed by Ax and Bjørnenak (2005), whose study of BSC diffusion in Sweden showed that its original framework had to be amended during implementation to suit 'local' culture and conditions. This was achieved by including an employee perspective, a link to an intellectual capital model, and the use of non-budgetary control systems.

However, the Balanced Scorecard is not without limitations. Many studies investigate the limitations of the concept in general (Butler et al., 1997; Epstein and Manzoni, 1998; Norreklit, 2000; Heinz, 2001; Kennerly and Neely, 2002; Olson and Slater, 2002).

The basic premise of Balanced Scorecard is simple. Financial measures are, and always will be important, but must be supplemented with other indicators that predict future financial success. Four perspectives of balanced scorecard will allow companies to record financial results and at the same time supervise the process of building skills that are necessary for obtaining the "intellectual capital" or "invisible assets", which is necessary for future growth and to provide keen competition. Unlike the traditional efficiency measurement system based on financial control as a core, balanced scorecard starts with an organizational vision and strategy. The attempt is to translate vision and strategy into performance measures that can be followed and used to measure success in the process of their implementation. This is achieved firstly by defining set goals and measures in each of four interrelated perspectives: financial, customer, internal processes and learning and growth of employees.

Balanced Scorecard identifies the indicators (measures) for each specific goal under those four perspectives, and also indicates the interactions among them. In order to implement the Balanced Scorecard model, management must determine the significance of all relationships among perspectives and their relative importance as well. In this sense, the analytic network process might be a significant support.

Financial measures should be supplemented as much as possible with non-financial measures of performance. A balanced scorecard combines historical, less predictive financial measures with four nonfinancial perspectives. Despite difficulties in measurement, some non-financial criteria are considered important in foreign subsidiary and its management performance evaluation system. Non-financial criteria reinforce financial measure and highlight the difference between managerial and unit performance. Important non-financial measures of performance involve: market share, customer satisfaction (retention), relation with host country government, quality control, environment compliance, employee development and safety, research and development in foreign unit and productivity improvement. As nonfinancial measures are subjective as compared with their financial counterparts they are not meant to replace, but to enhance the value of traditional quantifiable and objective financial measures.

### ***Separating subsidiary performance from manager performance***

Although the above mentioned criteria are used for both subsidiary and its management evaluation, a clear distinction must be drawn between foreign subsidiary and its management

## **THE IMPACT OF FOREIGN CURRENCY TRANSLATION ON FOREIGN SUBSIDIARY PERFORMANCE**

---

performance. It is critical that MNCs distinguish between manager performance and subsidiary performance. It is only one way to reward and keep good managers. As local management influences the performances of a foreign subsidiary through its operating decisions, it should be evaluated only on the basis of influential and controllable financial statements' items. Headquarter's management makes transfer pricing and funds transfer decisions. Foreign exchange control carried out by host government may affect earnings of foreign subsidiary. Responsibility accounting suggests that assets, liabilities, costs, and revenues should be traced to the individual manager who is responsible for them. Individual manager should not be responsible for uncontrollable costs, nor should be rewarded for uncontrollable revenues. However, the performances of foreign subsidiary are not affected by only actions of local management, but headquarters' management, the host government and the parent company's government, too. In other words the performance of a foreign subsidiary is the result of decisions made by many parties. Evaluation system should be able to separate subsidiary from managerial performance. There is a variety of factors that affect subsidiary performance, but over which managers may not have control. It is possible to have good management performance despite poor subsidiary performance and vice versa. The poor overall performance of the subsidiary may be largely due to the circumstances beyond the manager's control. (Doupnik and Perera, 2007) Managers should be evaluated on the basis of controllable items that affect the performance measure over which the local manager has control. In other words, local management should be evaluated only on the bases of financial statements items it can influence. It can be done by dividing each financial statement item into controllable and non-controllable.

In practice most MNCs don't make a distinction between the evaluation of the foreign subsidiary and its managers and use the same performance measurement techniques. As they often use profit it has to be decided whether profit should be measured in local currency or parent company currency.

### ***Choice of currency in performance measuring***

Frequent exchange rates fluctuations pose a great challenge to foreign subsidiary and its management performance evaluation. Performances of foreign subsidiary and its management can be measured in home country currency, local currency, or both. The selection of currency can have a significant impact on the performance evaluation of foreign subsidiary and its management when exchange rates fluctuate.

If profit is used as performance measure a major issue that must be addressed is whether profit is measured in local subsidiary currency or in parent company currency. It is crucial issue in performance evaluation in international setting because profit is not only individual measure, but it is often used in identification of the other performance measures. Profit should be measured in local currency if the foreign subsidiary is not expected to generate parent currency for payment of dividends to shareholders. If profit is measured in parent company currency the company selects a method of foreign subsidiary financial statements translation and decides whether to include effects of exchange rate changes.

There is no principal differences between US and non-US MNCs regarding the reporting treatment of transactions gains or losses. Treating them as a part of profit, transaction gains or losses are included in the performance measures of both the foreign subsidiary and its manager. On the other side MNCs are not consistent in their treatment of translation adjustment which results from foreign currency financial statements translation. In contrast to US MNCs, a significant majority of non-US MNCs don't include translation gains or losses in the performance measures of foreign subsidiary and its manager.

### Accounting aspects of foreign currency translation

Foreign subsidiaries and their managers may be evaluated in terms of the foreign currency or parent-country currency. Frequent exchange rates fluctuations pose a great challenge to foreign subsidiary and its management performance evaluation.

When exchange rates are stable both currency perspective yield the same performance measures. Fluctuating exchange rates add complexity to the foreign subsidiary performance evaluation. Hence, the selection of currency can have a significant impact on the performance evaluation of foreign subsidiary and its management when exchange rates fluctuate. The selected currency framework can turn losses expressed in local currency into gains measured in home country currency, or *vice versa*. Those favoring a local currency framework argue that foreign currency transactions are done in foreign currency and occur in foreign environment. Some favor a parent currency figures because headquarter's management is judged by domestic currency returns, and shareholders care about domestic currency returns. Translation foreign subsidiaries' results into parent currency expressed ones makes it easier the evaluation and the comparability of foreign subsidiaries. While most US. MNCs prefer a parent currency perspective, non-US multinationals generally employ local perspective for foreign subsidiary and its manager performance evaluation.

Those MNCs prefer a parent company currency perspective are confronted with the very complex and controversial accounting for foreign currency translation. There are two basic accounting aspects of foreign currency translation in foreign subsidiary and its management performance evaluation: (a) the translation of foreign currency transaction and (b) the translation of foreign subsidiary's financial statements. A clear distinction must be drawn between transaction gains and losses (resulting from the translation the foreign currency transactions) and translation gains and losses (stemming from the process of translation foreign currency financial statements to their presentation currency equivalents). MNCs are consistent in their financial reporting treatment of transaction gains or losses. While transaction gains or losses are always included in income, translation ones may be alternatively included in income or in equity. Correspondingly, these two aspects of foreign currency translation exert different influence on foreign subsidiary and its management performance evaluation.

Foreign currency transactions require settlement in a foreign currency. Today foreign currency sales, purchases, borrowing or lending funds transactions are regular occurrence. Thus a subsidiary selling the goods or purchasing inventory on credit may suffer a foreign exchange (transaction) loss or gain whenever the exchange rate changes between the transaction and settlement dates. Collections from export sales or payments for imports are not always made in a subsidiary local currency. It depends on negotiated terms. The key issue in accounting for foreign currency transactions is: how to deal with the change in the local currency value of the sales revenue and account receivables resulting from the export credit sale when the foreign currency changes in value. In other words, should the sale revenue be directly adjusted (one-transaction perspective) or should it be separately treated as a Transaction gain (loss) (two-transaction approach) for the effect of change in value of foreign currency transactions? There are two methods of accounting for changes in the value of a foreign currency transaction when subsidiaries use foreign currency to settle export credit sales and import credit purchases. The first approach (one transaction approach) can be criticized because it hides the fact the subsidiary could have received more or less amount of cash if the foreign customer had been required to pay at the date of sale. Disregarding the fact that these two different approaches influences the subsidiary result in the same way, International Accounting Standard (IAS) 21, The Effects of Changes in Foreign Exchange Rates, requires the subsidiary to use a two transaction approach for foreign currency transactions. As regards to the foreign currency transaction of foreign subsidiaries it has to take into consideration the fact that foreign subsidiary performance evaluation is based on its both realized and unrealized transaction gains or losses.

## **THE IMPACT OF FOREIGN CURRENCY TRANSLATION ON FOREIGN SUBSIDIARY PERFORMANCE**

---

Besides foreign currency transactions, accounting for foreign currency translation includes foreign subsidiary financial statements translation. In the context of foreign subsidiary performance evaluation it is very important to select appropriately translation method. Applied method of translation foreign subsidiary financial statements may have impact either on equity or profit and hence affects performance evaluation. Recognizing that foreign subsidiary financial statements translation methods affect performance of MNC as a whole and their foreign subsidiaries it is necessary to deep consider their implication on key performance measures.

### **The impact of foreign currency financial statement translation methods on subsidiary performance**

The foreign subsidiaries of MNC keep their own accounting records and prepare set of financial statements in their local currency. As a result the individual financial statements of foreign subsidiaries are expressed in many different currencies. Process of preparing consolidated financial statements of MNC as a whole involves adding up the individual subsidiaries assets, liabilities, revenues, and expenses expressed in different currencies. As it is not possible to add up assets, liabilities, revenues, and expenses expressed in different currencies, subsidiaries' financial statements must all be expressed and hence translated in a single currency of the country where the MNC is headquartered, i.e. in a parent country currency.

The four methods of foreign currency translation are the current rate method, the current/non-current method, the monetary/non-monetary method, and the temporal method. MNCs should consider which of these methods best reflects economic reality for the particular foreign subsidiary being evaluated. It is very important to consider if translation effects are involved into result or equity. If translation effect represents a part of the result it should always be encompassed in performance evaluation. On the other hand translation adjustment as a part of equity should be included into performance evaluation only when ROE as a performance measure is determined.

The two major methods of translating foreign currency financial statements have been used worldwide are the current rate method and the temporal method. These methods indicate which exchange rate to use for the foreign currency balances in financial statements of foreign subsidiary in order to translate these amounts into the domestic currency of parent company. The major differences among these translation approaches pertain mainly to the translation of the balance sheet items and a few amounts in income statement.

The current rate translation method is applied for translation of financial statements when the specific foreign subsidiary is self-contained and integrated with local economy. According to this method all foreign currency assets and liabilities are translated at the same exchange rate, i.e. the current rate (the rate on the balance sheet date). Foreign currency income statement items are translated at exchange rate prevailing when revenues and expenses are recognized or for the expediency at the weighted average rate in effect during a given time period. As this approach uses a single translation rate, the current rate method is the simplest of all off the translation methods. As a result of the application of a single rate, original financial statement relationships and hence performance measures of individual subsidiaries are preserved. The only one exception from this translation rule refers to equity which is translated by historical rate. In that case originally identified performance measures based on the relationship between some items translated at the current rate and items translated at historical rate are not preserved. Translation of a historical cost number by a current rate makes little economic sense and produces amount which is neither historical cost nor current value. Every time when exchange rate changes this method gives rise to translation gains or losses. If this translation adjustment is included in income statement it could be significantly distort reported performance measures. ...The fundamental conditions underlying the temporal method is that foreign subsidiary has very close ties to its parent company and carries out its daily operations and keeps its

books in the parent country currency. Under this method assets and liabilities reported on the foreign subsidiary's balance sheet at historical cost are translated at a historical exchange rates. Assets and liabilities reported on the foreign subsidiary's balance sheet at a current value are translated at the current exchange rate. When different exchange rates are used for translation of different accounts, the financial statement relationships after translation differ from the corresponding relationships before translation. If it is considered that financial performance measures are calculated on the base of translated data, then this translation method must be questioned. Although the application of this translation method maintains the underlying valuation method, some academic and professional accountants have criticized the temporal method on the ground that the effects of its application, representing merely a mechanical by-product of translation process, are included in income.

### **Conclusion**

Three of the more widely used financial performance criteria used by MNCs for evaluating their foreign subsidiaries are profit, return on investment and budgeted comparisons. The differing economic, political and business conditions between countries and even within countries at different points in time require corporate management to periodically review the performance criteria for each unit. Companies must be flexible and pay attention to company specific variables in designing performance evaluation system. It is critical that MNCs distinguish between manager performance and subsidiary performance. There is a variety of factors that affect subsidiary performance, but over which managers may not have control.

There are a number of other factors that must be considered in designing performance evaluation systems for foreign subsidiaries. Comparability is desired ingredient of the performance evaluation system. The type of transfer pricing policies within an organization impacts the revenues of selling subsidiaries and costs of buying subsidiaries. The performance of subsidiaries may not be comparable if they use different transfer pricing policy. A number of macro-economic variable adversely affect comparability. The differing levels of inflation, differing levels of political stability, labor situation in that country can have a significant impact on the subsidiary in that country. As the frequent exchange rates fluctuations performance evaluation of foreign subsidiaries and their managers is very difficult task to be done.

Important issue that companies must address is the choice of appropriate currency for measuring the performance of foreign subsidiaries. There are two factors that companies must consider when selecting the currency to be used in performance evaluation. First factor relates to the role of specific subsidiary in the company's overall strategy and second is the responsibility for foreign currency risk management. Measurement of profit in local currency is considered to be appropriate if the foreign subsidiary is not expected to generate parent currency for payment of dividends to stockholders. If the foreign subsidiary is not given the authority to manage its currency exposure it cannot be held accountable for the effects of exchange rate fluctuations on its profitability. If parent currency is used in evaluating performance, the company must translate foreign currency profit into parent currency and decide upon which translation method should be applied. The four methods of foreign currency translation are the current rate method, the current/non-current method, the monetary/non-monetary method, and the temporal method. MNCs should consider which of these methods best reflects economic reality for the particular foreign subsidiary being evaluated. It is very important to consider if translation effects are involved into result or equity. If translation effect represents a part of the result it should be encompassed in performance evaluation. On the other hand translation adjustment as a result of foreign currency financial statements translation should not be included always into performance evaluation, but only when return on equity is determined.

## THE IMPACT OF FOREIGN CURRENCY TRANSLATION ON FOREIGN SUBSIDIARY PERFORMANCE

---

### References

- Ahn, H. (2001) 'Applying the Balanced Scorecard Concept: an experience report', *Long Range Planning* 34, pp 441-461.
- Atkinson A, Epstein M (2000). Measure for measure. *CMA Magazine* 74 (7): 22-28.
- Ax, C., and T. Bjørnenak (2005) 'Bundling and Diffusion of Management Accounting Innovations: the Case of the Balanced Scorecard in Sweden', *Management Accounting Research* 16 (1), pp. 1-20.
- Bourne, M., Mills, J., Wilcox, M., Neely, A. & Platts, K. (2000), Designing, implementing and updating performance measurement systems, *International Journal of Operations & Production Management*, 20 (7), pp. 754-771.
- Brabazon, T. (1999), *The Balanced Scorecard*, London: The Association of Chartered Certified Accountants.
- Butler, A., Letza, S. R., & Neale, B. (1997), Linking the Balanced Scorecard to Strategy, *Long Range Planning*, 30 (2), pp. 242-253.
- Chenhall, R. H. (2005), Integrative Strategic performance measurement systems, strategic alignment of manufacturing, learning and strategic outcomes: an exploratory study, *Accounting, Organizations and Society*, 30, pp. 395-422.
- Choi, F. D.S. and Meek G. K. (2008). *International Accounting* (sixth edition). New Jersey: Pearson Education International
- Choi, F.D.S. and Czechovicz, J. (1996). Assessing Foreign Subsidiary Performance: A Multinational Comparison. In: *Readings in International Accounting*, (Blake, J. and Hossain, M., eds.). London: International Thomson Business Press, 274-288.
- Domanovic, V. (2010). Balanced Scorecard – mogućnosti i efekti primene (Balanced Scorecard – Possibilities and Effects of Implementation). Faculty of Economics, University of Kragujevac. Vol. 334p. ISBN 978-86-6091-009-9.
- Doupnik, T. and Perera, H. (2007). *International Accounting*, International Edition. New York: McGraw-Hill.
- Ghalayini, A. M., Noble, J. S. (1997), An integrated dynamic performance measurement system for improving manufacturing competitiveness, *International Journal of Production Economics*, 48, pp. 207-225.
- Heinz, A. (2001), Applying the Balanced Scorecard Concept: an Experience Report, *Long Range Planning*, 34 (4), pp. 441-461.
- Hudson, M., Smart, A. & Bourne, M. (2001), Theory and Practice in SME performance measurement systems, *International Journal of Operations & Production Management*, 21 (8), pp. 1096-1115.
- Kanji, G. K., and P. M. Sa, (2002) 'Kanji's Business Scorecard', *Total Quality Management*, 13 (1), pp. 13-27.
- Kaplan, R. S., Norton, D. P. (1992). The Balanced Scorecard: measures that drive performance. *Harvard Business Review*. Vol. 70: 71-79.
- Kaplan, R. S., Norton, D. P. (1993). Putting the Balanced Scorecard to work. *Harvard Business Review* 71(5): 134-142.
- Kaplan, R. S., Norton, D. P. (1996a). *The Balanced Scorecard*, Boston, MA: Harvard Business School Press.
- Kaplan, R. S., Norton, D. P. (1996b). 'Linking the Balanced Scorecard to Strategy', *California Management Review*, Fall, pp. 53-79.
- Kaplan, R. S., Norton, D. P. (2000). *The Strategy focused organization: how balanced scorecard companies thrive in the new business environment*. Boston: Harvard Business School Press. 411p. ISBN 1-57851-250-6.
- Kaplan, R. S., Norton, D. P. (2001). 'Transforming the Balanced Scorecard from Performance Measurement to Strategic Management', *Accounting Horizons*, 15, pp. 87-104.
- Kaplan, R. S., Norton, D. P. (2004). 'How Strategy Maps frame an Organisation's Objectives', *Financial Executive* 20 (2), pp. 40-45.
- Kasurinen, T. (2002) 'Exploring management accounting change: the case of the balanced scorecard implementation', *Management Accounting Research* 13 (3), pp. 323-344.



- Kennerly, M., Neely, A. (2003) Measuring performance in a changing business environment. *International Journal of Operations and Production Management*. Vol. 23: 213-229.
- Kennerly, M., & Neely, A. (2002), Performance Measurement Frameworks: a Review. In: Neely, A., (ed.) *Business Performance Measurement: Theory and Practice*, pp. 145-155. Cambridge: Cambridge University Press.
- Maisel, L. S. (1992) 'Performance Measurement: the Balanced Scorecard Approach', *Journal of Cost Management*, Summer, pp. 47-52.
- Mooraj, S., Oyon, D. and D. Hostettler (1999) 'The Balanced Scorecard: a Necessary Good or and Unnecessary Evil?' *European Management Journal*, 17 (5), pp. 481-491.
- Neely, A. D., Mills, J. F., Gregory, M. J. Platts, K. W. (1995). Performance measurement system design –a literature review and research agenda. *International Journal of Operations and Production Management* 15 (4): 80-116.
- Nils-Göran, O., Roy, J., Wetter, M. (1999). Performance drivers: a practical guide to using the Balanced Scorecard. New York: John Wiley. 353p. ISBN 0-471-49542-5:
- Nørreklit, H. (2000), The balance on the Balanced Scorecard – a Critical Analysis of some of its Assumptions, *Management Accounting Research*, 11 (1), pp. 65-88.
- Olson, E. M., & Slater, S. F. (2002), The Balanced Scorecard, competitive strategy and performance, *Business Horizons*, 45 (3), pp. 11-16.
- Olve, N. G., Roy, J. and M. Wetter (1997) *Balanced Scorecard*, Svensk Praktik, Sweden: Liber AB.
- Paranjape, B., Rossiter, M., Pantano, V. (2006). Performance measurement systems: successes, failures and future—a review. *Measuring Business Excellence* 10(3): 4-14.
- Pun K, White A (2005). A performance measurement paradigm for integrating strategy formulation: a review of systems and frameworks. *International Journal of Management Reviews* 7 (1): 49-71.
- Ritter, M. (2003) 'The Use of Balanced Scorecards in the Strategic Management of Corporate Communication', *Corporate Communications: an International Journal* 8 (1), pp. 44-59.
- Simons R (2000). Performance measurement & control systems for implementing strategy. Prentice-Hall, Inc. 780p. ISBN 0-13-234006-2.
- Sinclair D., Zairi, M. (1995). Effective process management through performance measurement: part III – an integrated model of total quality-based performance measurement. *Business Process Re-engineering & Management Journal* 1(3): 50-65.
- Tangen S. (2005). Analysing the requirements of performance measurement systems. *Measuring Business Excellence* 9(4): 46-54.
- Taticchi P., Tonelli F., Cagnazzo, L. (2010). Performance measurement and management: a literature review and research agenda. *Measuring Business Excellence* 14(1): 4-18.
- Waterhouse J. M. (1999). Reporting practices: measuring up". *CA Magazine* (March): 41-48.



# MANAGEMENT ACCOUNTING ASPECT OF ENVIRONMENTAL COSTS

**Dejan Jovanović<sup>1</sup>**

**Marina Janković<sup>2</sup>**

**Abstract:** *In contemporary business conditions, environmental costs are a significant item in the structure of total costs. Since the environmental costs can arise during and after the production process, their control and reduction in the value chain focuses management attention on the development of strategies which will deal with effects of working operations on environment. The information on these costs are produced by environmental accounting, which combines financial accounting aspect and management accounting aspect. For the purpose of more efficient environmental cost management, more efficient decision making, minimizing total operating costs and increasing the performance of environmental protection there should be close cooperation between management and environmental management accounting. Bearing in mind the above mentioned, the paper will indicate the concept of sustainable development, environmental accounting, environmental costs, and environmental cost management in the value chain.*

**Keywords:** *sustainable development, environmental accounting, environmental costs, cost management*

## Introduction

The second half of the previous century was characterized by significant degradation of environment and the reduction of available natural resources, as a result of various human activities. Environment is an ambient where all human activities are performed, the source of raw materials and energy, but also the place where people dispose waste from production and consumption. For this reason, modern enterprises are forced to incorporate the elements for environmental improvement in their policies and business principles.

Many countries have found the solution to reduce the waste that comes out of production and consumption in pollution control, which implies the use of various technical and technological solutions, and pollution prevention by introducing cleaner production. Given the definition of the United Nations Environment Programme (UNEP), Cleaner Production is a comprehensive implementation of preventive environmental strategy aimed at the production processes, products, and services, with the aim to increase the overall efficiency and reduce the risks to human health and environment.

In order for contemporary business to be consistent with the concept of sustainable development and to create the ambient for cleaner production, the existence of environmental accounting system is necessary. The main role of environmental accounting at the level of business segment is reflected in the generation of information relevant to making strategic and operational business decisions, but taking into account the effect of operations on the environment. In this way a solid foundation for the improvement of competitive advantages is provided, but also for the protection and improvement of the environment.

---

<sup>1</sup> Faculty of Economics, University of Kragujevac, djovanovic@kg.ac.rs

<sup>2</sup> Valjevo Business School of Applied Studies

Special emphasis in this paper will be placed on the contribution to environmental improvement by the EMA and environmental cost accounting as its subsystem, as well as on the EMA techniques and their importance in analysing and managing costs.

### **The concept of sustainable development - a new development paradigm**

The concept of sustainability or sustainable development, although a relatively new concept, has existed for some time as an idea. The idea has existed in the works of classical economics (Smith, Ricardo, Malthus), when they tried to answer the question of survival prospects and development of all mankind. The thesis of pessimistic perspective of human society development, according to the classics, was refuted by the technical and technological progress, geographical and scientific discoveries in the nineteenth century. Several decades of steady growth after the World War II have further supported the belief in the unlimited potential of scientific and technical progress in the development of economy and society. However, oil shocks accompanied by the increase in price of energy inputs and raw material, marked the end of an optimistic era of economic thought. New advances of natural sciences, especially in the field of physics and biology, are opening a new chapter in economic thought and contributing to the appearance of a new discipline, the environmental economics, whose first contributions are reflected in the pollution analysis from an economic point of view.

The origins of sustainable development concept are linked to the work of "The Limits to Growth" (Meadows et al. 1972), focused on the depletion of resources and possible growth limits, which drew the attention of the wider world, economic, and scientific community to the need for more efficient organization of human activities. Sustainable development is often defined as "development that meets the needs of the present without compromising the ability of future generations to meet their own needs" (Brundtland Report WCED, 1987). Also, the World Commission on Environment and Development (WCED) has given an expanded definition that includes social and economic aspect in addition to environmental aspects. Thus sustainable development is a process of transformation in which the resource exploitation, investment direction, technological development orientation, and institutional changes are altering everything into harmony and enhancing current and future satisfaction of human needs and aspirations.

We can say that the concept of sustainable development involves coordination of various sectoral interests and priorities. Sustainable development requires trade-off between the desired quality and real pace of social development and different social values. For this reason, sustainability must contain in itself environmental, social, and economic dimension, which should be in a balanced relationship (Fig. 1). A sustainable economy is one of the prerequisites, i.e. necessary but not sufficient condition for achieving sustainable development.

The concept of sustainability has become widely accepted as a condition for survival and progress of mankind, but also as a new development paradigm, strategy, and philosophy of social development. The reasons for this are moral, environmental and economic. The theory of justice (Rawls, 1971), emphasizes the fundamental principle of moral justice, the right of the present generation to use the environment and resources must not compromise the same rights of future generations. Ecological reasons stem from the fact that man is a part of nature and has no right to change it irrevocably. Sustainable development is more efficient from the economic point of view, because it leads to a reduction in waste of resources and energy, i.e. it reduces the tendency of long-term deterioration of the input-output relation in the world trade.

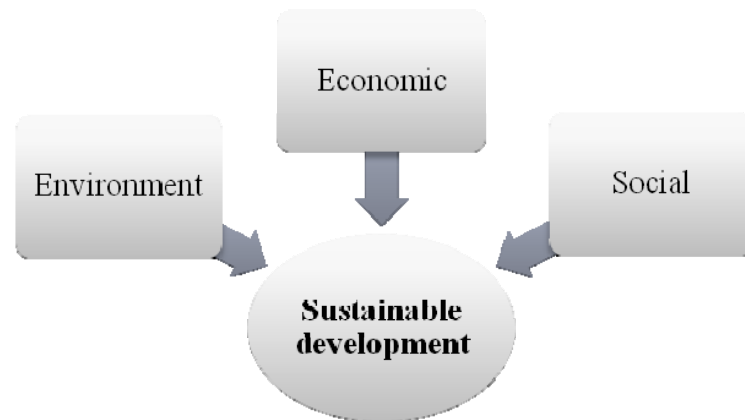

**Figure no. 1: Sustainable development and its three balanced dimensions**

Regardless of different interpretations that can be found in the literature, this concept takes the central role in considering the long-term prospects of mankind's survival and progress. The concept of sustainable development is one of the basic concepts of the economics of natural resources and environment. Since the sustainable development emerges as an essential prerequisite, but also as the ultimate goal of the effective organization of a number of human activities on the planet, from an economic point of view it is necessary to introduce a comprehensive system for recording, monitoring and managing environmental costs, i.e. to introduce environmental accounting.

The signals are clear – the sustainable development concept and cleaner production as a part of it, indicate the necessity of a comprehensive system for recording, monitoring and managing environmental costs that are inherent to every business process, as to give an opportunity to future generations to perform their economic activities and improve their way of life with the same (or at least similar) chances.

### **Environmental accountig (EA)**

Up to the period when economic activity was "low" in relation to the natural abundance, economists excluded the nature from their vision and treated "environmental services" as free goods. However, when the polluted air and water caused damage to the society, which implied the emergence of economic losses, economists became aware that environmental services had their price. This is corroborated by the first estimated costs of sustainable development on the planet in the amount of \$ 625 million (Injac, 2004).

Historically speaking, 1978 can be considered the year of the occurrence of EA, because it is linked to the publication of the first book<sup>3</sup> which presents the issues of environmental accounting. Accordingly, the EA has arisen from the need to include the management efforts, through bookkeeping, in obtaining relevant information on the investments in prevention and improvement of the environment. An additional contribution to the development of EA was made by the adopted document "EPA Action Agenda" in Rio de Janeiro in 1993, which was the UN Conference Action Program for the environmental protection and development of the country for XXI century. The document: An Introduction to Environmental Accounting - As a Business Management Tool: Key

<sup>3</sup> Müller, W. and R. Wenk. (1978). Die ökologische Buchhaltung: eine Informations und Steuerungsinstrument für umweltkonforme Unternehmenspolitik. Frankfurt/Main, New York

Concept and Terms, published in its entirety in 1995 by the Environmental Protection Agency – EPA, particularly stands out as a starting point for further researches but also as the basis for the EA concept.

The concept of environmental accounting involves all areas of accounting, which must adapt to the new requirements in a business system, because of its orientation to the environment protection up to the lowest level<sup>4</sup> (Gray, Bebbington, 2003). It includes the identification, allocation and analysis of material flows and their related cash flows, in order to provide insight into the impact of the environment on financial performances (effects) (Steele, Powell, 2002). It should also be emphasized that EA as a system does not represent a new accounting, but is a special approach to collecting, systematising, recording and reporting on ventures undertaken and investments in environmental protection (Gajić et. al. 2010).

EA can be viewed at the macro and micro level (Figure no. 2). The essence of micro accounting is reflected in the information production related to environmental costs, in order to get eco balance at the macro (national) level, which would be the basis for additional measures to protect and improve the environment. Of course, this does not exclude the existence of eco balance at the micro level, which would signal to business entities the types of environmental costs, their amount, and place of origin, all in order to establish an adequate system for their management and reduction to an acceptable level. The environmental reporting should contribute to (Department for Environment, Food and Rural Affairs, 2001):

- The improvement of business system reputation on the market,
- The ensuring of better communication with stakeholders,
- Better access to risk management, and
- The facilitation in discovering additional savings opportunities in using the resources and operating costs.

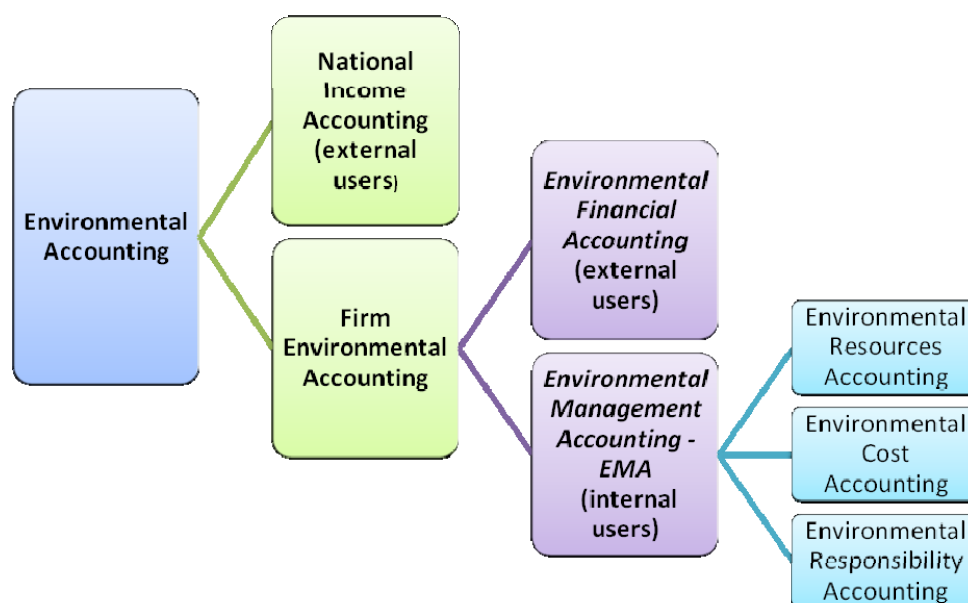

**Figure no. 2: The Structure of Environmental accounting (Graff et. al. 1998, Peršić, 2007)**

<sup>4</sup> Environmental Responsibility Accounting

EA is a system that with its timely, relevant, and truthful information gives support in making management's business decisions at different levels of decision-making hierarchy. For this reason, it represents the most important part of the entire business enterprise system, but also an essential part of the entire economic system of a country. Accordingly, National Income Accounting is aimed at providing economic and other information used in determining the national income and economic health. It is a macro-economic measurement which can use physical and monetary units to display the national natural resources (renewable and non-renewable). National Income Accounting focuses on monitoring and reporting of performed actions and their effects in the context of air protection, waste reduction and classification, saving water, etc.

Given the business system as a separate entity, EA may be regarded as financial EA and management EA. In order to adequately manage the environmental costs, it is first necessary to include, through bookkeeping, all properly systematized types of environmental costs, which is the subject of environmental financial accounting. The bases of reporting are the GAAP principles, in the context of which the Environmental Financial Accounting includes evaluation and public reporting on enterprise obligations towards the environment and environmental costs. On this occasion it is necessary to make certain adjustments, for financial accounting is based on the provisions of the Act on Accounting (in Serbia, the Law on Accounting and Auditing), international financial reporting standards, tax regulations, and other reporting requirements on the protection and enhancement of environment at the national and international level (Peršić, 2007).

When accounting encompasses the resulting environmental costs, it is necessary to assume and arrange them to responsibility areas or in places where the costs incurred as a result of business activities focused on environmental protection. According to the Figure no. 2, management accounting, which is internally oriented, can provide specific information for the management of resources, costs, and responsibility areas. Environmental cost accounting, as a part of environmental management accounting is aimed at providing information necessary for the effective environmental cost management. Special emphasis will be placed precisely on this part of management accounting, since an adequate management of environmental costs provides more effective decision making, cost savings, and increase in the effect of measures for protection and improvement.

Evidently, the need for EA follows from the fact that each company doing its business<sup>5</sup> manufacturing products or providing services, more or less harms the environment producing various kinds of pollution, with inadequate attitude towards waste, and exploitative treatment of raw materials. For this reason, when organizing the accounting functions it is necessary to understand business processes and enterprise activities, as well as inputs and outputs associated with them, in order for the company management to achieve defined objectives for the protection and improvement of the environment, based on the information contained in the reports of firm environmental accounting. Environmental management accounting has a special role in preserving the environment, making business decisions that will not affect the environment negatively and reducing the eco costs.

### **Environmental management accounting**

Environmental management accounting (EMA), as part of EA, is a useful instrument for overcoming the limitations of conventional management accounting, it provides a better understanding of the importance of social responsibility and helps in making business decisions regarding the environment (Burritt et. al. 2002). EMA, not only helps companies to better manage costs, but also strengthens the reputation of the company in society.

---

<sup>5</sup> Most frequently cited as the biggest polluters are industrial, transportation and mining companies, but also the agriculture.

In literature and in practice there is no generally accepted and universal definition of EMA. However, IFAC in a broader sense defines EMA as the process of identifying, collecting, analysing, and using two types of information used for decision making at the level of business segment, as follows:

1. physical information on consumed energy, water, materials (including waste), and
2. monetary information related to environmental costs and expected benefits.

Key aspects of the definition can be systematized as follows (Gibson, Martin, 2004):

1. EMA focuses on costs incurred within the company, and does not include the costs of individuals and society arising out of the company for which the company is not legally responsible,
2. EMA places particular emphasis on environmental cost accounting,
3. EMA, in addition to the information on environmental costs, includes explicit information on the physical flows and fate of materials and energy,
4. EMA information can be used for most activities of management and decision-making, but are most useful for making decisions about environmental protection.

According to the above mentioned it can be said that the aim of EMA is to create an information base from which to examine the impacts of a company on environment as well as the environment on the company. As such, EMA serves as an information support to managers in making decisions that will contribute to the environmental protection and increase of company's financial performances.

The information support of ECM is reflected in the provision of quantitative and monetary information to managers, where the quantitative information are related to the physical units (meter, kilogram, litre, ...), and monetary information related to the values of costs and benefits expressed in monetary terms. The possession of such information relating to the exact information on the amount of waste and emissions, both in physical and monetary terms, is of primary importance for cost management and reduction of negative impacts of the company on the environment. Due to this characteristic, Burritt et al. 2002 divided EMA into two parts (Figure 1):

- monetary environmental management accounting (MEMA), and
- physical environmental management accounting (PEMA).

MEMA focuses on the company activities, with environmental aspects, expressed in monetary units, such as the measures expressed through the expenses for cleaner production, penalty costs for violating environmental laws, investments in capital projects that enhance the environment and the like. On the other hand PEMA refers to recognizing the influence of a company on the natural environment expressed in physical units, such as a kilogram of waste material, joule of energy per product unit, and the like (Burritt et. al. 2002). It can be said that the key difference between MEMA and PEMA is in the manner of understanding the impact of activity on the natural environment.

As highlighted previously, EMA should create relevant information basis, in which the centre will be the information on economic impacts of adopted business decisions, as well as information on the amount of costs and benefits, associated with the implementation of environmentally significant programs and projects. In achieving its goal EMA should place the emphasis on the choice of the instrument which will ensure the preparation and transparent presentation of the information, primarily on the use of materials and energy, changes in the structure of environmental costs, but also on other related categories of business decisions, with special emphasis on the effects of management activities concerning the promotion and protection of the environment. Successful and socially responsible



companies within the EMA imply the existence of segments, responsible for insuring the information for the management of environmental resources (environmental resource accounting), environmental costs (environmental cost accounting) and environmental segments (responsibility accounting - green accounting) (Figure no. 2).

Accounting in Monetary Units		Accounting in Physical Units	
Conventional Accounting	Environmental Management Accounting		Other Assessment Tools
	MEMA Monetary EMA	PEMA Physical EMA	

**Figure no. 3. EMA elements (United Nations Division for Sustainable Development, 2001)**

Contemporary EMA places particular emphasis on responsibility accounting tasked to prepare information bases to segments, necessary for assessing the responsibility of different hierarchical levels of management, in the area of improvement in the attitude towards the environment, improvement of environmental cost management, investments in clean technologies, development of green processes and products, and designing the range of supply, which will be based on ecological grounds and which will ensure optimal balance between value for money. Environmental responsibility accounting, as the lowest level of reporting on the relation between business segments and environment, is based on the information on environmental costs, which selects and connects with other relevant information and harmonizes at higher hierarchical levels, thus providing the conditions necessary for planning, assessment and control of business decisions made by the managers of business segments.

By incorporating and implementing EMA, companies have numerous advantages that are reflected in cost reduction, more competitive product price, optimal use of resources, innovations, cleaner production, value increase for shareholders, and the improvement of company's reputation in terms of social responsibility. However, to achieve the above advantages, the existence of environmental cost accounting, which will recognize environmental costs in the structure of total costs, is essential.

### **Environmental cost accounting and environmental costs**

Companies and managers usually believe that environmental costs do not have great importance for the activity they perform. They do not take into account that production costs have their environmental component. For example, the purchase price of raw materials is the production cost, but in itself it includes the environmental cost related to the unused portion that goes to waste and that is usually not considered environmental cost in companies. However, the environmental costs threaten to reach much higher levels than initially expected and should be controlled and kept to a minimum by introducing ecologically clean production wherever possible. Such an approach to environmental costs imposed the need for establishing environmental cost accounting (ECA), as a sub-segment of EMA. ECA's task is to identify, collect, classify and record all the costs incurred as a result of the measures of investment in the protection and improvement of environment, as well as the savings and exchange of resources. Accordingly, in ECA the emphasis is on assessing the costs associated with investing in the protection and improvement of the environment, which differs from the classical approach where

the emphasis is on creating an adequate cost-accounting database as an information base intended for users.

To be able to meet the requirements, ECA should create such a methodological base that will allow the identification and presentation of conventional costs related to environmental protection, and many more previously unknown categories, which requires a broader understanding of the costs. In order to encompass all environmental costs, most frequently mentioned division in the literature is shown in Figure no. 4.

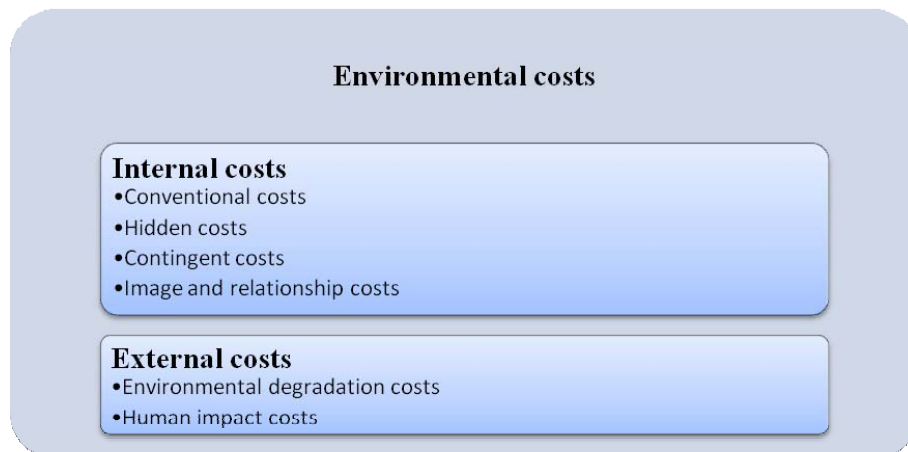

**Figure no. 4: Types of environmental costs (Beer, 2006)**

The figure indicates that the internal costs include conventional, hidden, contingent, and image costs and relation with stakeholders. Conventional costs include the cost of capital equipment, raw materials and supplies, while hidden include the anticipatory (e.g. testing licenses, engineering permits), individual (e.g. stopping or destroying equipment), voluntary (e.g. recycling, protection, testing) and overheads (e.g. planning, testing, target monitoring, insurance). As for the contingent costs, their existence is uncertain and depends on uncertain future events. Image costs and relationship with stakeholders are difficult to measure because they derive from subjective perception of management, customers, employees, local communities, country. External costs also belong to the group of costs difficult to measure and include the costs of environmental degradation incurred by companies that are not legally responsible, and costs arising from the negative impact on human beings, their property and well-being (e.g. river pollution due to sewage spills, the impact of air pollution on asthma sufferers, etc.) (Environment Protection Agency, 1995).

As environmental cost represent specific type of costs, their recording requires recognizing, identification and determination of their amount, for individual cases as well, using different methodological approaches. Observation that many of these costs merge in the group of overheads, whose share in total costs increases significantly, creates additional problems in identifying them. What must not be forgotten, when it comes to environmental costs, is the fact that they appear in the case of investments in environmental protection and in the case of missed opportunities, which further complicates the process of recording and managing these costs.

By creating a methodological base that will enable the identification, recording and allocation of all environmental costs, ECA will work toward preventing pollution, it will become an integral element in the decision making process and instrument for the realization of business strategy.

In comparison with traditional cost accounting, environmental cost accounting has a much harder task, because it needs to include costs, and revenues, which are primarily hidden and should be assessed and allocated depending on the flow of material resources or business operations, which means that it is closely oriented to specific working processes in the company. The environmental costs are always associated with product and process, but also with the conditions in which the product or service is offered (Peršić, 2005). Since it is not always easy to recognize environmental costs, most of these costs should be predicted and controlled with a good knowledge of possible future events, because some will occur prior to the activities themselves, and some will depend on the emergence of possible future events. Information on environmental costs are essential when determining the profitability of investments in various activities to improve environmental performances, the need for investment in clean technologies, as well as the development and promotion of environmentally acceptable processes and products (Peršić, 2005).

As investments in the protection and improvement of the environment in the long term bring multiple benefits, and retention of the status quo implies the emergence of costs due to the negligence towards the environment, the observation of environmental costs should be based on the same starting points on which the study of the costs of quality is based. Environmental costs should be viewed as the costs of quality, because the investment in the protection and preservation of the environment is at the same time the investment in higher quality, and the costs incurred because of the expansive development, maintaining the status quo, or negligence of the environment are at the same time the costs of quality deviations (Jovanović, Janković, 2011), so they need to be especially controlled and their mitigation and elimination from the process influenced with special measures.

Environmental costs can often be reduced or avoided by pollution prevention practice, such as changing the product appearance, input substitution, process redesigning, operational improvements and the like. The research conducted in 1985 and 1992, by the INFORM oil group, showed that the average annual savings per project for pollution prevention in production capabilities were even \$ 351.000. However, as many of these costs are hidden or hardly visible it is very difficult to assess which part of the total costs derived from product production or some other process, and which refers to environmental costs. If these categories are not divided we cannot know exactly how much the cost price actually reflects production costs. To overcome this problem it is necessary to establish ECA in the accounting information system, which will ensure that all of these types of costs are identified, timely encompassed, classified and recorded in relevant accounting records and books, in order to find their place in the accounting reports, by appropriate information requirements of internal and external users. All these costs have incurred as a result of the measures of investing or not investing in the protection and improvement of the environment. Environmental cost accounting records and assigns (allocates) overheads (hidden eco costs) to those products due to which they have incurred.

Environmental costs may arise during and after the manufacturing process, therefore the control and reduction of such costs in the value chain focuses management attention on strategy development which will deal with the effects of the operations on environment (Raiborn et. al. 2006). An adequate management of environmental costs creates conditions for better utilization of raw materials and assisting materials in business processes with less waste and scrap. Numerous researchers have investigated the benefits of EMA implementation. The results showed that the use of EMA and ECA as its sub-segment, reduces costs (Burrill, Saka, 2006), encourages innovation and cleaner production, increases shareholder value and strengthens the competitive position of the company (Wahyuni, 2009). These benefits lead to the increasing social responsibility, or the production of ecological products whose negative impact on the environment will be minimized. Example for this is the Andersen Corporation, which generates about 50% of yield in its production process of innovations generated from wood waste. Furthermore, Kodak Company recycled 77 to 86 percent of camera materials from return products and saved significant costs.

To achieve results in the reduction of environmental costs it is necessary to have timely information on the impact of their activities on immediate and wider environment. This information can be provided only within relevant reports on the impact of company on the condition in environment, prepared in accordance with the pre-known and generally accepted methodology, which will provide monitoring of the impact of certain measures on environmental improvement. In order to provide useful information in reports, an accountant has to cooperate with all levels of management, especially with the manager responsible for environmental protection. Thus, EMA, and within it ECA, should integrate corporate, environmental, and business policy. Only if the accounting reports on environmental protection are based on the quality information of internal calculation based on the principles of responsibility accounting, the accounting report will be verifiable.

The savings in total costs or environmental costs in the value chain can be achieved by implementing some of the EMA techniques, and EMA tools used in the analysis and cost management are of special importance in achieving the above.

**Ema techniques and tools for the analysis and cost management**

The EMA techniques in literature and practice are usually divided according to their focus in three main categories: costing analysis, investment appraisal, and performance management. (Figure no. 5).

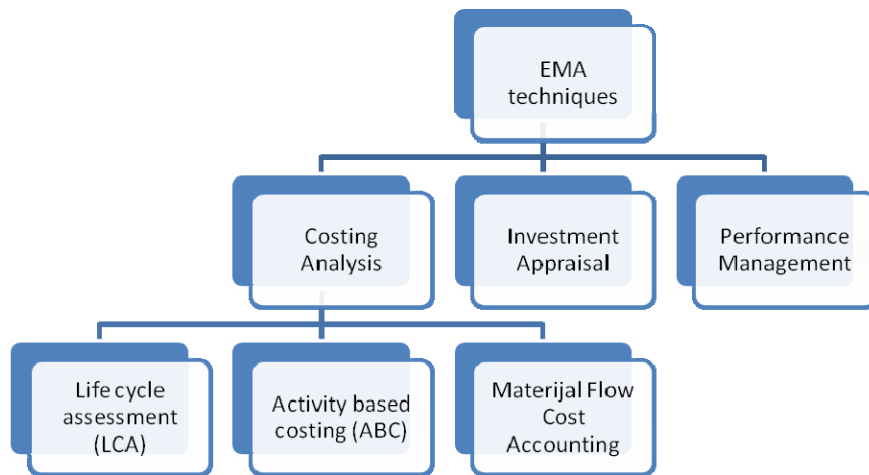

**Figure no. 5. EMA techniques (Wahyuni, 2009)**

Costing analysis, as shown in image no. 5., includes tools that are helpful in analysing and managing cost and they will be mentioned below. Investment appraisal is based on capital budgeting and is a long-term and comprehensive analysis of the future costs and benefits of planned investments. EMA tool for performance management is Environmental Balance Scorecard, which is defined as "a set of measurements that give top managers a fast, but comprehensive view of the business including the effects of operational and environmental measures on different company perspectives such as: customer satisfaction, internal improvement, research and training, and financial and other perspectives related to business strategy" (Wahyuni, 2009)

### ***Life cycle assessment***

The negative impact of a company on the environment may occur during each phase of product life cycle. Life cycle assessment analyses and evaluates the impact of a product or activity on the environment and environmental costs from raw materials to product disposal. Identifying the environmental costs incurred during the various stages in product life cycle provides the opportunity of understanding and managing costs throughout the product life-cycle. The analysis of environmental costs along the life cycle helps management to understand the impact of the development and production of product on the environment, identifying the areas where the most effective will be the efforts to reduce environmental costs and negative impacts of production on the environment.

Since the assessment of product life cycle is very complex it should be indicated to the accounting – organizational aspect of the invoice and settlement costs of the product lifecycle through three main phases: pre-production, production and post-production phase. These are the stages that are critical to the success and prospects of company's development, for numerous studies show that during the process of development and design, even 80% - 90% of the total product costs is engaged and destined to occur, which indicates the great importance of these early stages in terms of managing costs, particularly costs of prevention when it comes to environmental costs. After that, the product enters the production phase in which the costs are already engaged, so not much can be done in the field of cost reduction. The introduction of JIT technique and application of TQM program, zero defects, significantly contributes to the stimulation of activity in the area of production cost reduction and at the same time contributes to the increase in quality and reduction of the negative impact of production on environment. Finally, the costs of post-production activities have a very significant share of total product cost structures so they cannot be neglected if the company wants to achieve cost competitiveness on the market.

These phases of product development cycle are further differentiated to activities, which enables an easier way of encompassing and calculating all costs incurred during its useful life. The total product costs are distributed, monitored and analyzed at all stages of product life cycle, and within them activity costs are differentiated and monitored.

### ***Activity based costing (abc)***

The application of ABC costing system indicates that the majority of resources in companies are not used in a direct product production, but in providing activities for the support that assists the production and sale of a wide variety of products and services. The main objective of ABC is, first, to carry out the measurement of overheads by individual activities and then, using the drivers of activity costs, to allocate them to the final products and services, thus determining the price of cost which will be comprehensive and will include all the costs incurred by the product production. ABC allows companies a more accurate allocation of overheads, including environmental costs, because it assumes that each carrier of costs should burden with costs in proportion to the need to perform certain activities. Bennett and James (1997) claimed that another essential role of the ABC is to uncover the major-part of environment-related costs such as energy, water, waste disposal and the salaries of environmental staff which are commonly recognized as overheads (Wahyuni, 2009).

After ABC detects which part of overheads is related to environmental costs it should identify and use various cost drivers customized to the requirements of each specific activity. The implications of the accounting technique in the field of cost control are very important, because the information collected and more accurate allocation of costs helps the management to see the amount of environmental costs and who their drivers are.

Furthermore, ABC provides great opportunities for successful environmental cost management, which is extremely important if one takes into account the fact that the control and reduction of costs, in the contemporary business conditions, are more important than the exact calculation of cost price.

### *Material flow cost accounting (mfca)*

MFCA is a tool of the EMA that was developed in Germany in the nineties of last century and aims to define the flows of materials and energy through the process of creating value in a particular period, influencing that way on the reduction of companies' negative impact on the environment and environmental costs at same time. MFCA monitors and measures in physical and monetary units the flow and supplies of materials (raw materials, parts, and components) in the production process, thus pointing to the material losses as accurately as possible.

With MFCA there is no clear dividing line between the material forming a part of product and materials not contained in the product, that is to say waste. MFCA is based on the principle of quantifying the flows of materials at the point in the manufacturing process at which any material losses (wastes) are generated. In this calculation not only is the cost of the input materials included, but also processing costs such as labour costs and depreciation costs are allocated, both to products and material loss. This is because MFCA assumes that even for waste materials, processing has been applied and labour and equipment costs are thus involved. Waste is recognized as “another” product in this calculation. In addition to material costs and processing costs, waste disposal costs are therefore added to the cost of waste (Kokubu, Kitada, 2010).

Therefore, applying MFCA<sup>6</sup> leads to the increased material efficiency, because with the help of this tool we can identify opportunities to reduce material consumption, thus lowering the costs and negative impacts of a company on the environment. The implementation of MFCA tools in practice leads to more efficient estimations of investments in plant and equipment, improvements in product design and production planning, modification and replacement of materials, and the like.

### **Conclusion**

Sustainable development is a complex pragmatic compromise between the needs of the natural environment on the one hand and the imperatives of economic growth, on the other. Business in accordance with the concept of sustainable development imposes the need to coordinately introduce the application of EA at all hierarchical levels, from business structure up to national and international level. In this way, the EA is imposed as an indispensable resource in insuring the information that will provide company management with a relevant basis for managing and improving living and working environment, which is very important for the development of all activities and an essential precondition for sustainable development.

Increasing the awareness of environmental issues by the society and company means that the company no longer ignores the environmental impacts of its activities. The strategic objectives of companies should be based on long-term goals of sustainability, not only to target profitability. For this reason, modern companies must continually take care of nature conservation, that is to say firm environmental accounting should generate reports to management aimed at improving and protecting the environment, types of environmental costs, their level, but also the changes in several observed periods. EMA, as well as its techniques and tools, has the special importance in generating the information necessary for analyzing and managing environmental costs. EMA should also assist the management in the context of providing support in making decisions that affect the environment.

Therefore the EMA, and within it ECA, should be oriented to raising awareness of environmental issues and it should integrate corporate environmental and business policy. Integrating the concept of sustainable development into company operations and management acting in an

---

<sup>6</sup> More details on MFCA see: Guide for Material Flow Cost Accounting (Ver.1), March 2007, internet address: [http://www.meti.go.jp/policy/eco\\_business/pdf/mfca%20guide20070822.pdf](http://www.meti.go.jp/policy/eco_business/pdf/mfca%20guide20070822.pdf), date 15/06/2012

environmentally responsible manner will improve the market and economic position of contemporary company, especially the profitability and competitiveness.

## References

- Beer, de P. and F. Friend, (2006). Environmental accounting: A management tool for enhancing corporate environmental and economic performance, *Ecological Economics*, No. 58
- Burritt, R.L. & Saka, C. (2006), Environmental management accounting applications and eco-efficiency: Case studies from Japan, *Journal of Cleaner Production*, 14: 1262-1275
- Burritt, R.L., Hahn, T. & Schaltegger, S. (2002), Towards a comprehensive framework for environmental management accounting – Links between business actors and environmental management accounting tools, *Australian Accounting Review*, 12(2): 39-50
- DEFRA, (2001), *Environmental Reporting - General Guidelines*, Department for Environment, Food and Rural Affairs and the Department of Trade and Industry; Scottish Executive and the National Assembly for Wales, London. (10 July 2012) <<http://www.defra.gov.uk>>
- Gajić, Lj., Medved, I. and L. Rac. (2010). Obračun troškova i ekologija – novi pristupi unapređenja poslovanja, *Škola biznisa*, br. 4
- Gibson, K., Martin, B. (2004), *Demonstrating Value through the Use of Environmental Management Accounting*, Environmental Quality Management, Vol. 13, 3:45–52
- Graff, R.G., Reiskin, E.D., White, A.L. and K. Bidwell, (1998). Snapshots of Environmental Cost Accounting, United States Environmental Protection Agency Office of Pollution Prevention and Toxics Environment Accounting Project. (15 June 2012) <<http://www.dep.state.pa.us/dep/deputate/pollpev/pdf/allsnaps.pdf>>
- Grey, R. and J. Bebbington, (2003). *Accounting for the Environment*, SAGE Publications, London
- Guide for Material Flow Cost Accounting (Ver.1), March 2007, [http://www.meti.go.jp/policy/eco\\_business/pdf/mfca%20guide20070822.pdf](http://www.meti.go.jp/policy/eco_business/pdf/mfca%20guide20070822.pdf),
- Injac, N. (2004). *Okoliš i njegova zaštita*. Mala enciklopedija kvaliteta, Oskar, Zagreb
- Jovanović, D., Janković, M. (2011), *Uticaj koncepta upravljanja troškova kroz lanac vrednosti na troškove kvaliteta proizvoda*, Zbornik radova: Quality 2011, Univerzitet u Zenici, Mašinski fakultet, Neum
- Kokubu, K., Kitada H. (2010), Conflicts and Solutions Between Material Flow Cost Accounting and Conventional Management Thinking, A Paper Presented at the 6th Asia- Pacific Interdisciplinary Perspectives on Accounting Research (APIRA) Conference at University of Sydney on 12-13 July 2010, (25 June 2012) [http://apira2010.econ.usyd.edu.au/conference\\_proceedings/APIRA-2010-150-Kokubu-Material-flow-cost-accounting.pdf](http://apira2010.econ.usyd.edu.au/conference_proceedings/APIRA-2010-150-Kokubu-Material-flow-cost-accounting.pdf)
- Meadows, H.D, Meadows, L.D., Randers, J. and W.W. Behrens III, (1972). *Limits to Growth*, New York: New American Library
- Perišić, M. (2007). Zeleno računovodstvo – što je i kome koristi?, *Računovodstvo i finansije*, br. 12
- Perišić, M. (2005), Računovodstvo okoliša i održivi razvoj turizma, poglavlje u knjizi grupe autora „Održivi razvoj turizma“ (ur. V. Vujić), Fakultet za turistički i hotelski menadžment, Opatija, Rijeka, Sveučilište u Rijeci
- Raiborn, C., A., Kinney, M., R., Prather-Kinsey, J. (2006), *Cost Accounting*, Thomson Learning
- Rawls, J. (1971). *A Theory of Justice*. The Belknap Press of Harvard University Press
- Steele, A.P. and J.R. Powell, (2002). *Environmental Accounting: Applications for Local Authorities to Quantify Internal and External Costs of Alternative Waste Management Strategies*. Environmental Management Accounting Network Europe, Fifth Annual Conference, Leicestershire Business School,
- United Nations Division for Sustainable Development (2001), *Environmental Management Accounting Procedures and Principles*, Prepared for the Expert Working Group on “Improving the role of government in the promotion of environmental management accounting”, New York

## **MANAGEMENT ACCOUNTING ASPECT OF ENVIRONMENTAL COSTS**

---

Wahyuni, D. (2009), Environmental Management Accounting: Techniques and Benefits, *Jurnal Akuntansi Universitas Jember, Vol. 7, No. 1, pp. 23-35*

WCED. (1987). Our Common Future. The World Commission on Environment and Development, Oxford Univ. Press, Oxford and New York



# FINANCIAL BENCHMARKING: VALUE DRIVERS ANALYSIS

Dijana Sredić<sup>1</sup>

Tajana Serdar<sup>2</sup>

**Abstract:** *Financial benchmarking is the method of comparing business processes and results in one company to the processes and results known as the best in particular branch. The categories of value drivers are: operative (micro), financial (macro) and strategic (branch). In this paper will be used branch benchmarking in the section: Electricity, gas and water supply, class: Distribution and trade of electricity. Mentioned class in the Republic of Srpska contains five companies which financial data will be analyzed through the value drivers. Motive for this analysis is launched initiative for financing electricity meters change in order to decrease illegal consumption of electricity. The benchmarking is based on comparing the performances of the pioneer company in this project with the other four companies and the average of the class.*

**Keywords:** *financial benchmarking, value drivers, financial ratios, market ratios*

## Introduction

Financial benchmarking in this paper is carried out through value drivers' analysis on the example of companies in economic class: distribution of electricity in Republic of Srpska. The motivation for this analysis is a funding initiative launched in replacement of electric meters in order to reduce electricity theft, and financing replacement of the old installations to reduce losses in the electricity distribution which is assumed to the amount round 20 percent of the total energy production in the Republic of Srpska. (Statistical data show that 20 percent of total electricity production in the Republic of Srpska is not charged). At the level of holding MH ERS - MP JSC which includes five companies from the electricity distribution field: "Elektrokrajina" JSC Banja Luka, "Elektro Bijeljina" JSC Bijeljina, "Elektrodistribucija" JSC Pale, "Elektrohercegovina" JSC Trebinje and "Elektro Doboje" JSC Doboje, it is decided to begin operations in a company "Elektrokrajina". Therefore, this paper is based on comparison of the "Elektrokrajina's" performance to the other four companies and the average grade. The purpose of the work is to represent how financial benchmarking is used to increase benchmark companies in the same economic class thus measuring productivity, efficiency and achieve profit in companies connected to distribution of electricity. Financial results of mentioned companies are directly related to the project of electric meters replacement, and in our opinion, the best way to evaluate this investment project is through analyzing value drivers.

The first part of the work will give theoretical introduction to the financial benchmarking. In the second part the phases of benchmarking will be explained. Thereafter, value drivers will be presented by diagrams and analysis of each of them will be made. The fourth part consists of the benchmarking of share price movements and index whose calculation includes mentioned share prices. It will be calculated the yield for shareholders as well. At the end we will present research results and provide appropriate views and conclusions.

---

<sup>1</sup> The Republic of Srpska Investment-Development Bank, Banja Luka, sredicd@gmail.com

<sup>2</sup> Faculty of Economics, University of Banja Luka

**The terms and types of benchmarking**

Among the numerous benchmarking definitions, it seems the most comprehensive the one of Philip Kotler: “The art of determining how and why some individuals or companies do business better than others. This is a procedure of comparing business process and outcome to the processes and results of the best in the same or similar fields.”

Follow-up of the work contains comparative benchmarking of company “Elektrokrajina” JSC Banja Luka. Mentioned company with other four companies “Elektro Bijeljina” JSC Bijeljina, “Elektrodistribucija” JSC Pale, “Elektrohercegovina” JSC Trebinje and “Elektro Doboj” JSC Doboj enters in five branch companies: *Production and Distribution of Electricity*, class *Distribution and Sale of Electricity*.

Comparative benchmarking is defined as comparison of one company with another one, identical or similar. Summarizing the sources in the literature, the types of benchmarking are:

**Table 1: The Types of Benchmarking**

<b>Types</b>	<b>Increased emphasis on</b>	<b>Objectives</b>	<b>Benefits</b>	<b>Shortcomings</b>
<b>INTERNAL</b>	Functions, sections, projects, jobs in the same company or group on the same or another location	Improvement of competitiveness, Stimulation of continuous improvement, Increasing economic efficiency, Finding an efficient system of rewarding employees	The same language, culture, mechanisms and systems, Easy access to data, Existence of communication, Higher results	Possible lack of external problem focus and highlighted shortcomings of the company, Possibility of inadequate feedback related to the results, due to low level of improvement
<b>EXTERNAL</b>				
The best practice	Any organization in the sector or field	Identification of the best management practice	Possibility of progress, Better perspective of corporation, Stimulation of changes, Lower sensitivity to political surrounding	Relatively difficult access to data, High degree of change, Great public interest

Types	Increased emphasis on	Objectives	Benefits	Shortcomings
Competition	Competition	Identification of performances, objectives, strategies and programs of competition, Identification of the best management practice	The same structure and limitations, Relatively easy access to data, Relatively low level of treatment, Help in overcoming complex and arrogance	Sector model can bind creativity, Legal, ethnic and political observation
Sector	Specific or the same sector or branch	Identification of sector strategies and programs, Distribution of the best information and practice, Defining the training program	Easier access to industrial trends, Relatively easy access to information	Difficulties in getting to the specific recommendations, Results available even to the competition

Source: Codling, 1996, pp. 8-12.

Further, a sector benchmarking is carried out in the field of *Production Electricity, Gas and Water* in the class *Distribution and Sale of Electricity*, as we mentioned in the text above.

### Phases of benchmarking

1. Planning.
  - Selection of the observation field: In this paper, financial performance of the company “Elektrokrajina” JSC Banja Luka is considered through analyzing value drivers;
  - Identification of potential subjects to be compared with previously mentioned company: the four remaining companies from the field of Distribution and Sale of Electricity in Republic of Srpska;
  - Defining process and identifying data sources and methods: Data sources are financial statements, data from web site of Holding “Elektroprivreda Republike Srpske” and stock price movements in 2011 and available information on Banja Luka Stock Exchange related to share price movements of given companies and index whose calculation includes share prices.
2. *Data collection.* Data for ratios' calculation are derived from financial statements companies submitted to the “Agency for Intermediary, IT and financial services” Banja Luka, for the year 2011. Data on stock price movements and index whose calculation includes given share prices are obtained from Banja Luka Stock Exchange web site (<http://www.blberza.com>, 20 May 2012). Data on number of costumers and municipalities in which companies do their business are obtained from holding “Elektroprivreda Republike Srpske” web site.
3. *Analysis.* There are following methods of data comparing:
  - Standards of the analyst that reflect his experience of what is / is not considered to be normal indicator;

## FINANCIAL BENCHMARKING: VALUE DRIVERS ANALYSIS

---

- Comparison to the industry's in which company operates average or to the best form the branch;
- Comparison to the historical indicators of the same company (previous year);
- Comparison to the indicators entered into the plans of the company;
- Determined standards (common in literature).

Our work provides comparison to all companies form the branch of electricity distribution as in the specified branch operates only five companies.

4. *Application in practice.* Benchmarking analysis is used for better communication with the management structure, adjusting objectives, developing plans and their implementation.

### Value drivers

Value drives can be divided into:

1. Operational (micro) value drivers;
2. Financial (macro) value drivers;
3. Strategic (branch) value drivers.

The internal value of the subject is affected by the growth of the investment base and rate of cash yield. The growth of the investment base is achieved through profit growth of the company and more efficient management of the assets and liabilities. Return rate for an investment is the discount rate that equates the present value of all benefits (expected cash inflows) with the present value of all costs (expected cash outflows). Diagrams 1 and 2 display financial value drivers and value drivers for shareholders.

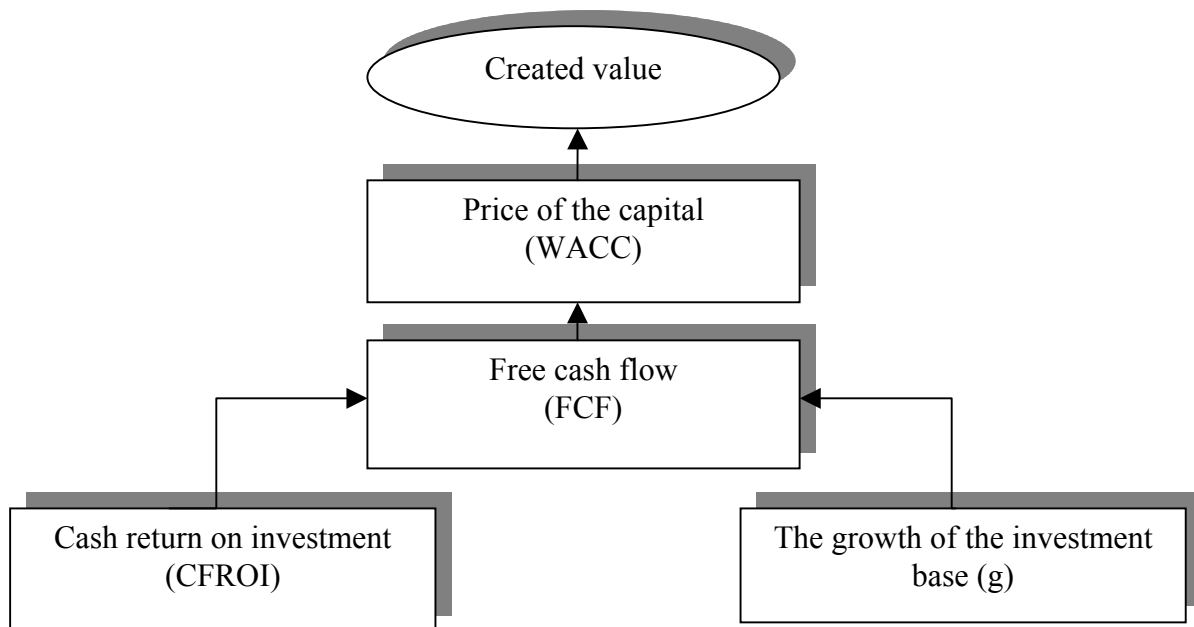

**Diagram 1: Financial Value Drivers**

Source: Damodaran, 2005, p. 809.

As it is evident at the previous diagram, financial value drivers, in fact, represent financial ratios. The most important ratios are free cash flow (FCF) and average capital price (WACC) which create value in company. Cash return on investment and the growth of investment base are indicators with impact on free cash flow. Having this in mind, we use financial ratios in our research and project of changing electricity meters' evaluation.

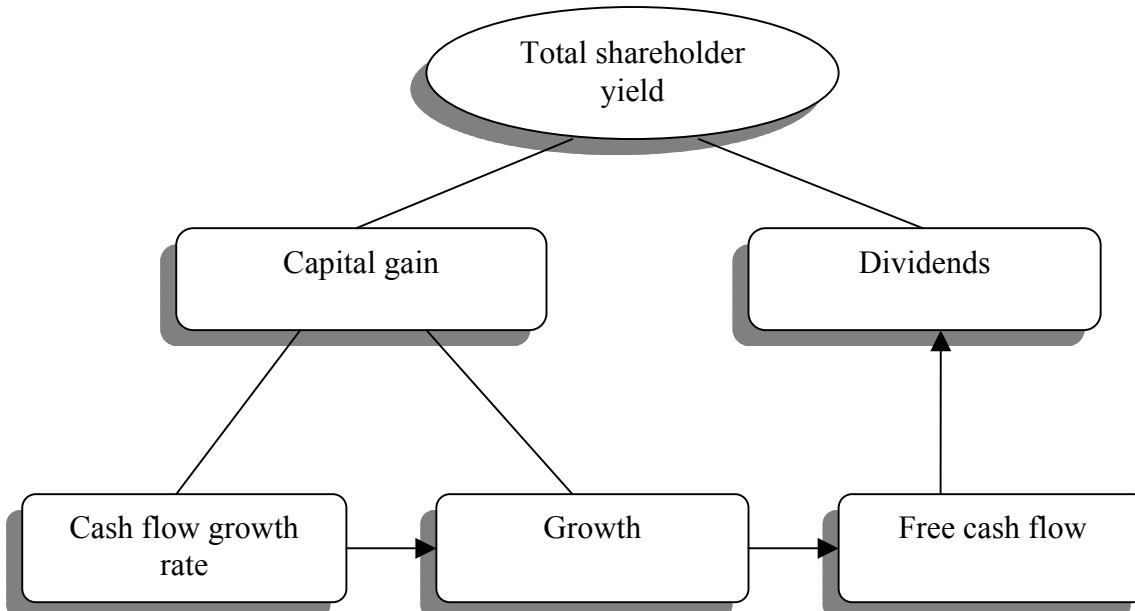

**Diagram 2: Value Drivers for Shareholders**

Source: Damodaran, 2005, p. 811.

Shareholder yield include capital gain and dividends. Likewise financial value drivers, value drivers for shareholders could be seen as financial ratios, such as cash flow growth rate and growth of the base. We will treat these value drivers in our analysis the same way as the financial value drivers.

Hence, all value drivers are compatible and have impact on each other. The following diagram presents how investment projects affect growth of investment base and then the indicators on the capital market. Hereafter, analysis of financial indicators is carried out for the value drivers, videlicet for the revenue and profit growth, efficient management of the assets and liabilities and the indicators on the capital market.

For the company, perspectives of parameters observing from the standpoint of the balanced scorecard can be divided into (Young, 2004):

1. Financial perspective;
2. Consumers' perspective;
3. Internal perspective;
4. Learning and Growth.

Our work implies financial benchmark in terms of value growth for shareholders from a financial perspective.

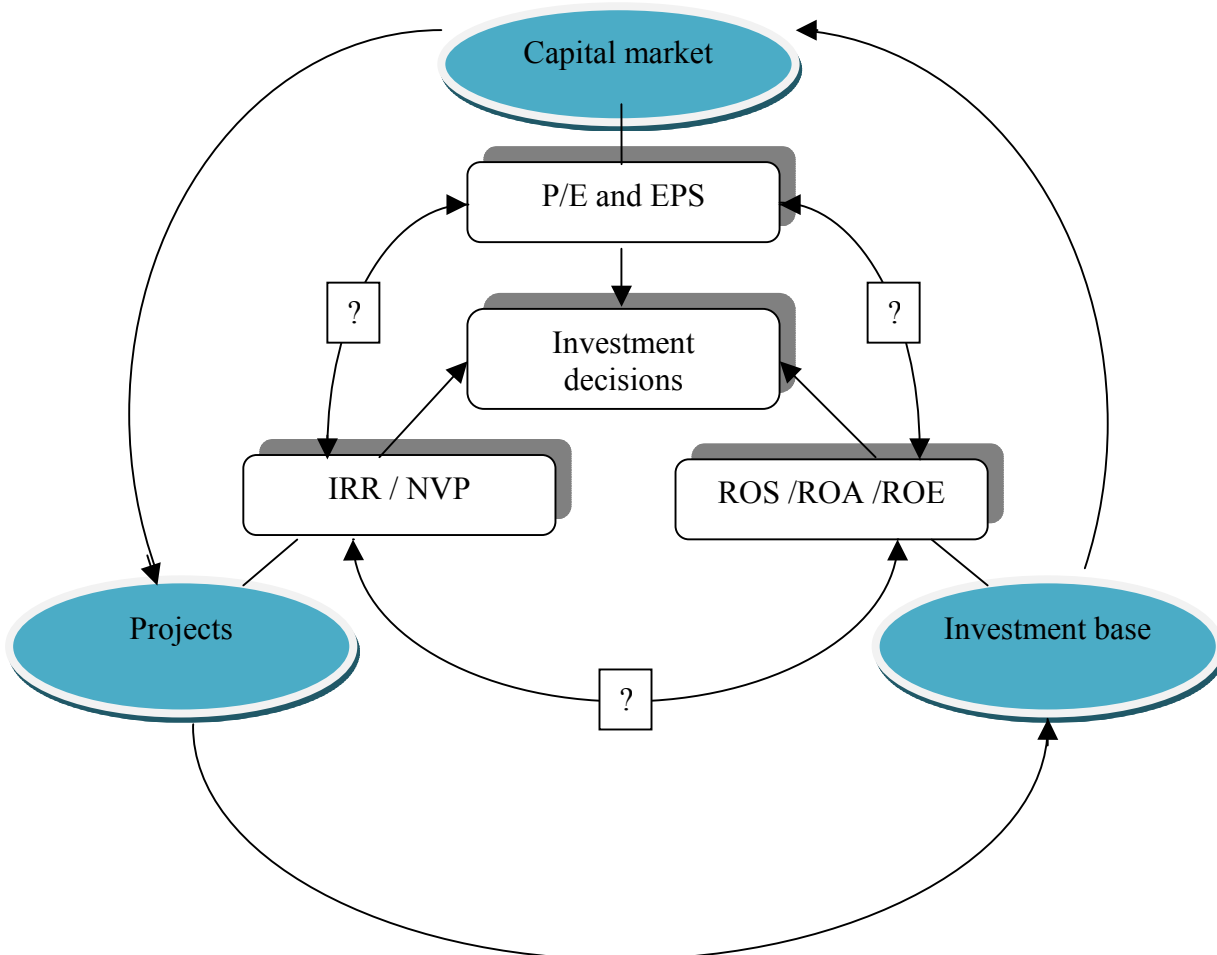

**Diagram 3: Compatibility of the performance benchmarks**

Source: Đuričin, 2009, pp. 4-6.

Based on data from the balance sheets for the year 2011, the indicators will be calculated for every company from the branch. Mentioned indicators are divided into groups:

1. Analysis of income, profit rate and taxes;
2. Analysis of the operative assets and capital investments;
3. Analysis of the capital cost.

In addition, following indicators will be calculated separately:

1. Liability ratios;
2. Market ratios;
3. Benchmarking of price movements and market indices;

4. Shareholder return;
5. Customer analysis.

In the last column of the table is shown the average of the branch. The following graphs present the movement of the indicators.

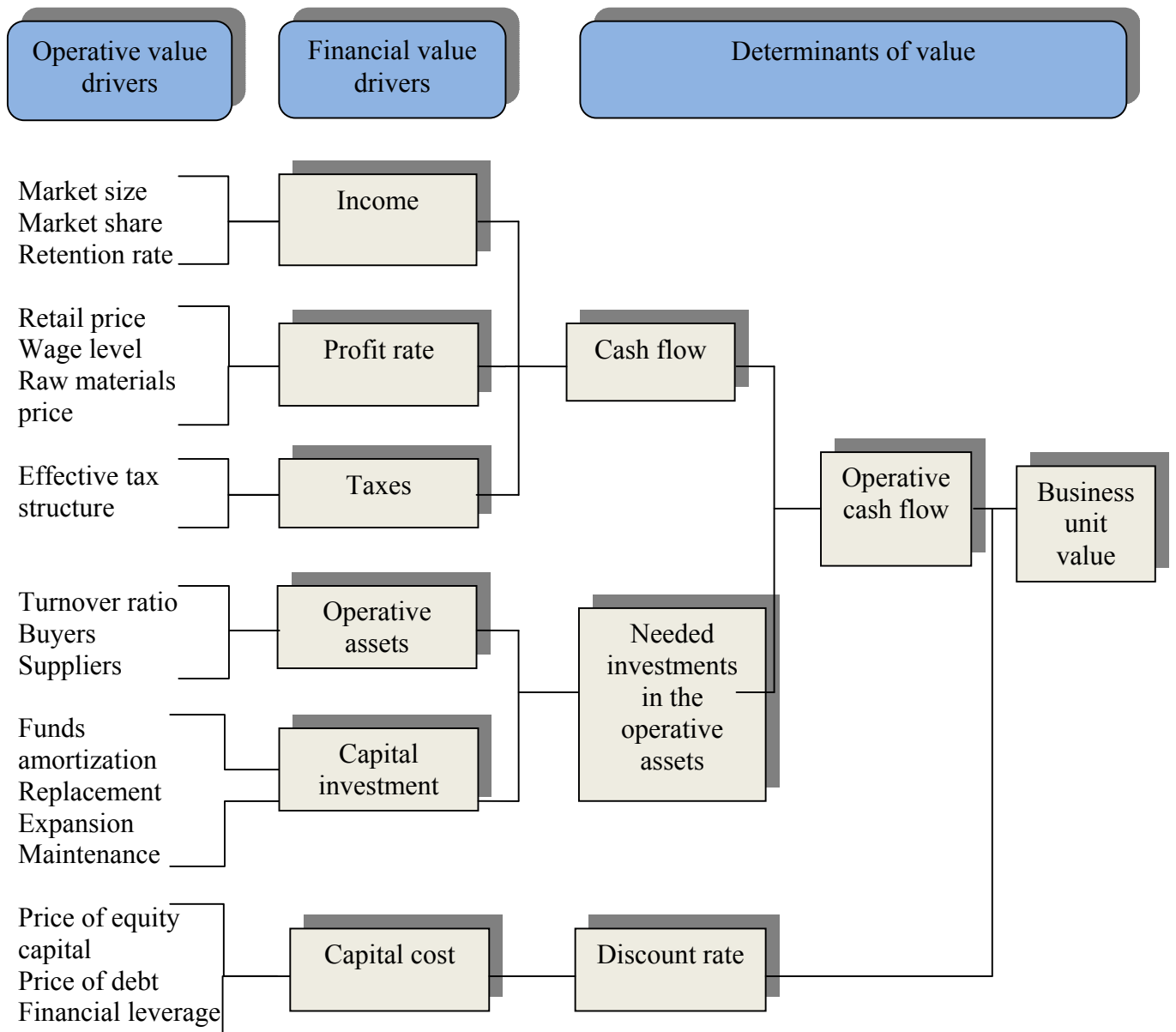

Diagram 4: Operative and financial value drivers

Source: Đuričin, 2007

**Research of the Companies in the Field of Production Electricity, Gas and Water in the Class Distribution and Sale of Electricity**

*Income and profit margin analysis*

**Return on Asset (ROA)**

It is a ratio of the net profit and the average asset. It shows a company's capability of profit earning.

**Return on Equity (ROE)**

calculated by dividing a company's net profit and its total equity. It is used as a marker of profit earning on equity investments.

**Return on Fixed Asset (ROFA)**

calculated by dividing a company's net profit and its averaged fixed equity (intangible assets, real assets, long term financial investments). It is used as a measure of quality of fixed asset usage.

**Sales Return**

calculated by dividing a company's net profit and its total proceeds. It is a contribution of a net profit in a total proceeds.

**Net inflow of cash from operating activities / Total proceeds**

calculated by dividing a company's net inflow of cash from operating activities and its income from sales of merchandise goods, products and services.

**Net inflow of cash from operating activities / Total Equity**

calculated by dividing a company's net inflow of cash from operating activities and its equity.

**Net inflow of cash from operating activities / Total Debt**

calculated by dividing a company's net inflow of cash from operating activities and its total debt.

**Table 2: Income and profit ratios**

Ratio	EKBL-R-A	ELBJ-R-A	EDPL-R-A	EKHC-R-A	ELDO-R-A	Average of Branch
Return on Asset (ROA)	0.06%	0.08%	0.01%	0.05%	0.42%	0.12%
Return on Equity (ROE)	0.09%	0.11%	0.01%	0.06%	0.50%	0.15%
Return on Fixed Asset (ROFA)	0.09%	0.09%	0.01%	0.06%	0.50%	0.15%
Sales Return	0.17%	0.20%	0.03%	0.13%	1.15%	0.34%
Net inflow of cash from operating activities / Total Income	4.28%	-2.86%	7.57%	0.91%	2.02%	2.39%
Net inflow of cash from operating activities / Equity	2.75%	-1.55%	3.75%	0.42%	0.87%	1.25%
Net inflow of cash from operating activities / Total Liabilities	4.84%	-5.41%	9.63%	1.72%	15.49%	5.26%
EBITDA Margin	14.41%	13.97%	19.71%	19.51%	16.75%	16.87%



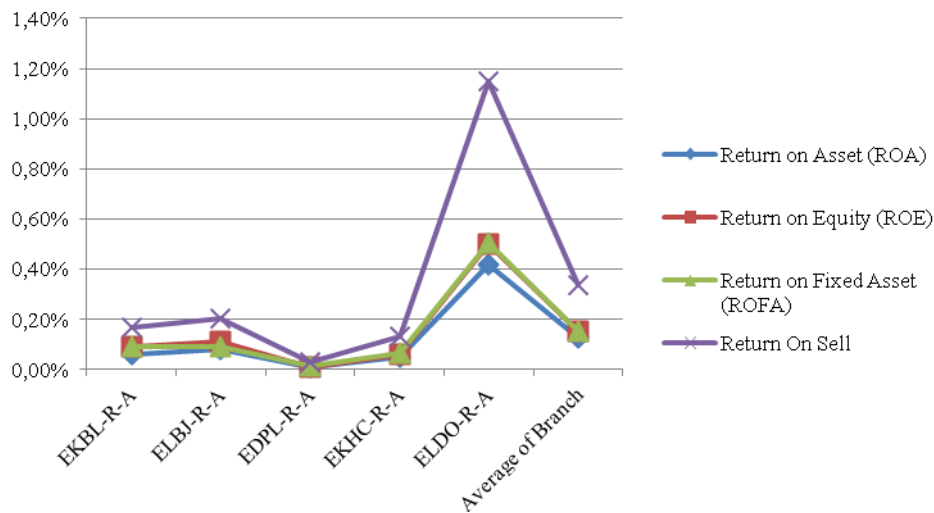

**Chart 1: Return Ratios**

All companies from the analyzed branch have had the positive total net income for the year 2011. “Elektro Doboј” JSC (ELDO-R-A) has had the highest ratios, while the investigated company “Elektrokrajina” JSC has had the average business results.

#### *Short-term asset and capital investment analysis*

##### **Average Receivables**

calculated by dividing the customers’ receivables from the beginning and from the end of the observed period.

##### **Average Receivables Turnover**

calculated by dividing the company’s total income and the average receivables.

##### **Collection Period**

calculated by dividing the total days in period (365) and the average receivables turnover.

##### **Average Accounts Payable**

calculated by dividing the accounts payable from the beginning and from the end of the observed period.

##### **Payables Turnover**

calculated by dividing the company’s total income and the average payables.

##### **Payables Period**

calculated by dividing the total days in period (365) and the average payables turnover.

##### **Inventory Turnover**

calculated by dividing the company’s total income and the average inventories.

##### **Current Ratio**

## FINANCIAL BENCHMARKING: VALUE DRIVERS ANALYSIS

calculated by dividing the current asset and the current liabilities.

### Acid Test Ratio or Quick Ratio

calculated by dividing the current asset reduced by the amount of inventories and the current liabilities ((cash+ receivables)/ current liabilities).

**Table 3: Short-term asset and capital investment analysis**

Ratio	EKBL-R-A	ELBJ-R-A	EDPL-R-A	EKHC-R-A	ELDO-R-A	Average of Branch
Average receivables	141,418,668	22,062,908	15,224,386	12,821,453	13,744,908	41,054,464
Average Receivables Turnover	1.25	3.67	2.47	1.74	4.67	2.76
Average Collection Period	291.11	99.57	148.00	209.29	78.15	165.22
Average Accounts Payable	99,582,613	10,998,785	10,698,813	3,585,943	1,794,128	25,332,056
Payables Turnover	2.02	7.91	4.13	7.09	36.02	11.43
Payables Period	180.33	46.14	88.48	51.51	10.13	75.32
Inventory Turnover	35.85	13.37	13.49	16.74	8.46	17.58
Current Ratio	1.32	1.41	1.70	2.31	6.97	2.74
Acid Test Ratio or Quick Ratio	1.29	1.13	1.52	2.13	5.22	2.26

Liquidity ratios: Current Ratio and Acid Test Ratio are the lowest for the observed company. Characteristic of this industry branch is the low level of inventories (electric power is not storable), therefore Current Ratio and Acid Test Ratio are not differing in the significant amount.

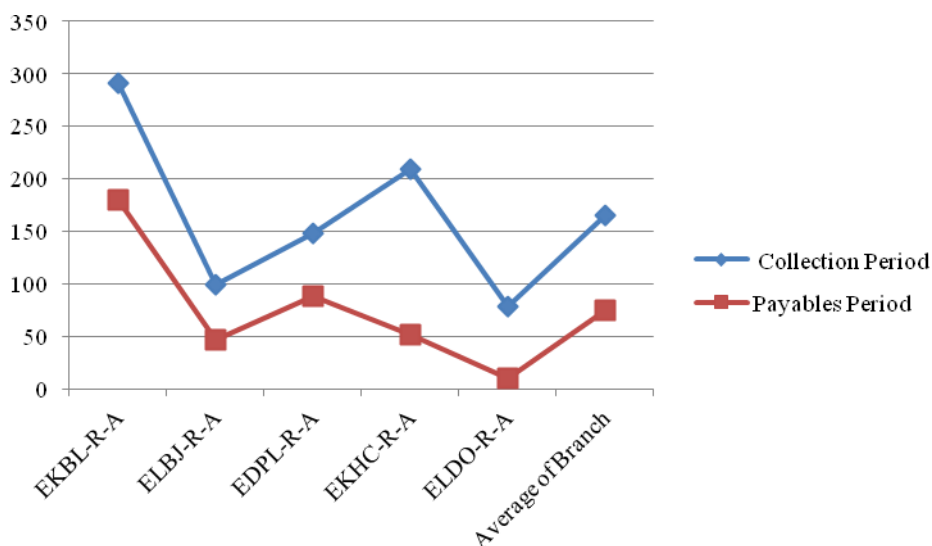

**Chart 2: Averaged Collection and Payables Period**

The collection period and payables period are the highest for the “Elektrokrajina” JSC Banja Luka in the respective to other companies. A worrisome fact is that the collection period is higher than payables period, which produces the financial straining to the subject.

**Study**

**Dividend per Share**

calculated by dividing the total dividend paid amount and the number of issued shares.

**Dividend Payout Ratio**

calculated by dividing the total cash dividend paid amount and the company’s net profit.

**Current Asset**

calculated by summing prepaid expenses and accrued income, short-term receivables investments, cash equivalents and cash.

**Short-term Financial Liabilities**

calculated by summing short-term financial liabilities and the accrued expenses.

**Short-term Financial Equilibrium**

calculated by dividing the current asset and short-term financial liabilities.

**Long-term Assets**

calculated by summing the fixed asset and total inventories.

**Long-term Capital and Liabilities (Long-term financing sources)**

calculated by summing the share capital, reserves and long-term liabilities.

**Long-term Financial Equilibrium**

calculated by dividing long-term asset and long-term capital and liabilities.

**Net-working Capital**

calculated by subtracting a company’s total current liabilities from its total current assets.

**Debt Capital Ratio**

calculated by dividing the total debt and the total capital.

For the reason of non-paying dividends in the past period, there is no possibility to calculate ratios which include dividend payments.

**Table 4: Cost of Capital**

Ratio	EKBL-R-A	ELBJ-R-A	EDPL-R-A	EKHC-R-A	ELDO-R-A	Average of Branch
Current Assets	173,082,969	26,519,543	35,067,657	17,901,771	31,300,391	56,774,466
Short-term Liabilities	135,895,513	23,580,751	16,831,847	7,579,882	4,924,157	37,762,430
Short-term Financial Balance	1.27	1.12	2.08	2.36	6.36	2.64
Long-term Assets	345,042,039	189,246,669	92,965,726	49,586,048	159,907,398	167,349,576
Long-term Financial Sources	381,469,268	174,393,870	102,092,652	58,071,435	178,166,397	178,838,724
Long-term Financial Balance	0.90	1.09	0.91	0.85	0.90	0.93
Net Working Capital	40,753,773	8,667,964	12,053,143	9,837,201	25,849,453	19,432,307
Debt/Capital Ratio	0.57	0.29	0.39	0.24	0.06	0.31

## FINANCIAL BENCHMARKING: VALUE DRIVERS ANALYSIS

The lowest boundary for short-term financial balance ratio is 1.00. All of the respective companies have this ratio bigger than one. The outstanding company, as in the previous cases, is “Elektro Doboj” JSC with extraordinary coefficient of 6.36. This may lead to the wrong conclusion, when average of the branch is concerned. Average short-term balance of other four companies is equal to 1.71 and when “Elektro Doboj” JSC is included average ratio is 2.64, almost for 1 higher.

The long-term financial balance ratio equal or less than one corresponds to the golden balance rule. In that case, there exists the long term financial equilibrium and financial stability because long-term sources are bigger than long-term assets and difference is used for financing short-term liabilities. Only “Elektro Bijeljina” JSC has not attained this limit, and it is slightly above 1.

### *Debt ratios*

#### **Long-term Liabilities/ Total Capital**

calculated by dividing the sum of long-term liabilities and long-terms reserves and the total capital.

#### **Total Liabilities/ Total Capital**

calculated by dividing the total liabilities (long-term liabilities + short-term liabilities) and the total capital.

#### **Total Liabilities/ Total Asset**

calculated by dividing the total liabilities and the total asset.

**Table 5: Debt Ratios**

Ratio	EKBL-R-A	ELBJ-R-A	EDPL-R-A	EKHC-R-A	ELDO-R-A	Average of Branch
Long-term Liabilities / Total Capital	0.17	0.15	0.18	0.09	0.03	0.13
Total Liabilities / Total Capital	0.57	0.29	0.39	0.24	0.06	0.31
Total Liabilities / Total Asset	0.32	0.18	0.22	0.19	0.05	0.19

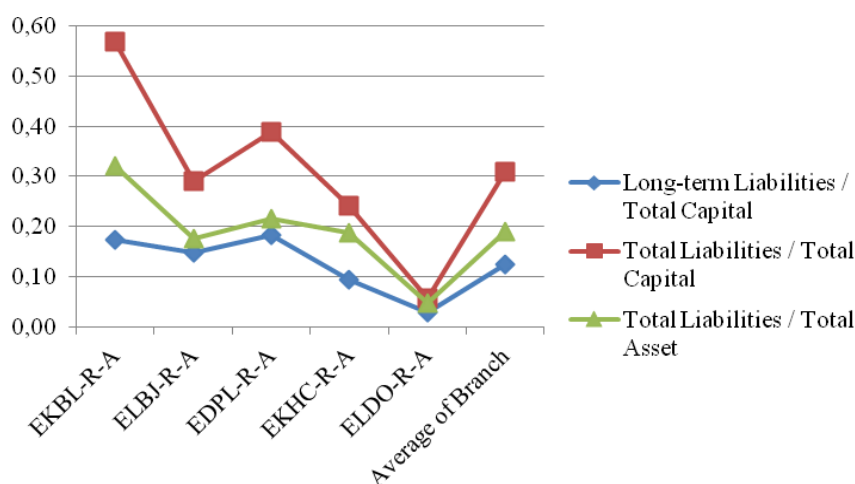

**Chart 3: Debt Ratios**

“Elektrokrajina” JSC has had the highest debt ratios, implying that the ratios are above the average of branch. The liabilities in that company are higher more than 50% of the company’s capital. In the structure of liabilities, the short-term liabilities are 2.2 times higher than long-term liabilities. Therefore, the ratio Long-term Liabilities / Total Capital is considerably lower than the ratio Total Liabilities / Total Capital.

***Market Ratios***

**Market Capitalization**

is defined as total market value of share capital. It is calculated as multiplication of the average market share price and the number of issued company’s shares.

**Earnings per Share (EPS)**

calculated by dividing the net profit and the number of issued company’s shares. It shows company’s profitability and the profit per a share.

**Price/Earnings per Share Ratio (P/E)**

calculated by dividing the average market share price and earning per share ratio. It shows how many money units is paid for a one money unit of the profit per a share.

**Book Value per Share**

calculated by dividing a capital book value and the number of issued company’s shares.

**Price to Book Ratio (P/B)**

calculated by dividing an average share price and the book value per a share.

**Price to Sales Ratio**

calculated by dividing the average market share price and the total income per a share. It shows how many units of money investor pays for a unit of income per a share.

**Table 6: Market Ratios**

Ratio	EKBL-R-A	ELBJ-R-A	EDPL-R-A	EKHC-R-A	ELDO-R-A	Average of Branch
Market Capitalization	27,775,263	11,661,547	5,528,565	5,132,407	19,542,080	13,927,972
Net Income per Share (EPS)	0.0033	0.0043	0.0007	0.0015	0.0247	0.0069
Price/ Earning (P/E)	92.2674	71.1916	479.6603	167.7696	25.4073	167.25924
Book Value per Share	3.4928	3.8766	5.0416	2.5387	4.9994	3.98982
Price To Book	0.0862	0.0782	0.0694	0.1008	0.1256	0.09204
P/S ratio	0.1547	0.1474	0.1472	0.2295	0.3044	0.19664

From the data above it is obvious that all of the companies have very high book value per a share, in the compare to the market value of a share. One of the reasons for low valuing of the shares by the market participants is the low level of the profit, which is incurred by high level of costs. P/S ratio is low and approximately the average market price is 6.5 times lower than the value of the sales per a share.

***Benchmarking of price movements and market indices***

The shares of 5 analyzed companies are included in calculation of index ERS10. Besides of those companies, shares in the index structure are:

1. “Hydro Power Plants at Drina” JSC Višegrad,

## FINANCIAL BENCHMARKING: VALUE DRIVERS ANALYSIS

2. “Hydro Power Plants at Vrbas” JSC Mrkonjić Grad,
3. “Hydro Power Plants at Trebišnjica” JSC Trebinje,
4. “RiTE Gacko” JSC Gacko,
5. “RiTE Ugljevik” JSC Ugljevik.

On the charts using the linear regression, there are shown movements of the index ERS10 and the share prices of all 5 companies during the year 2011.

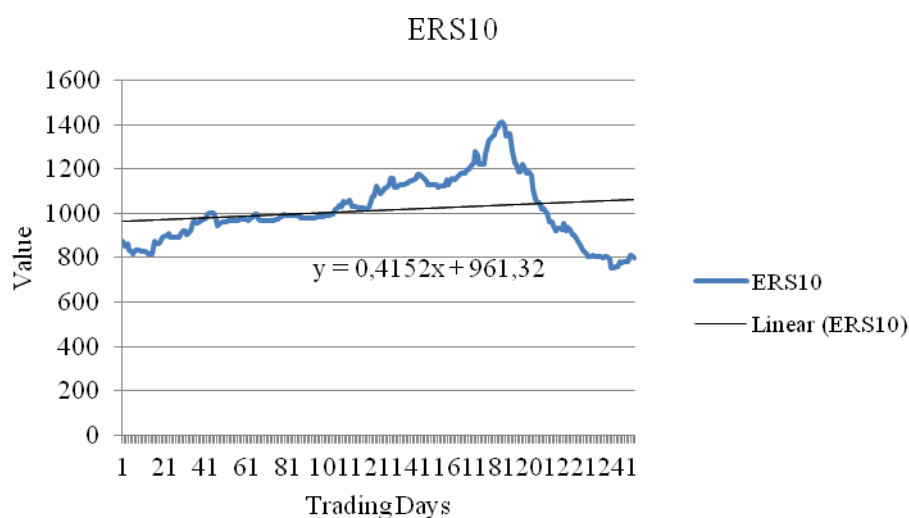

**Chart 4: Index ERS10**

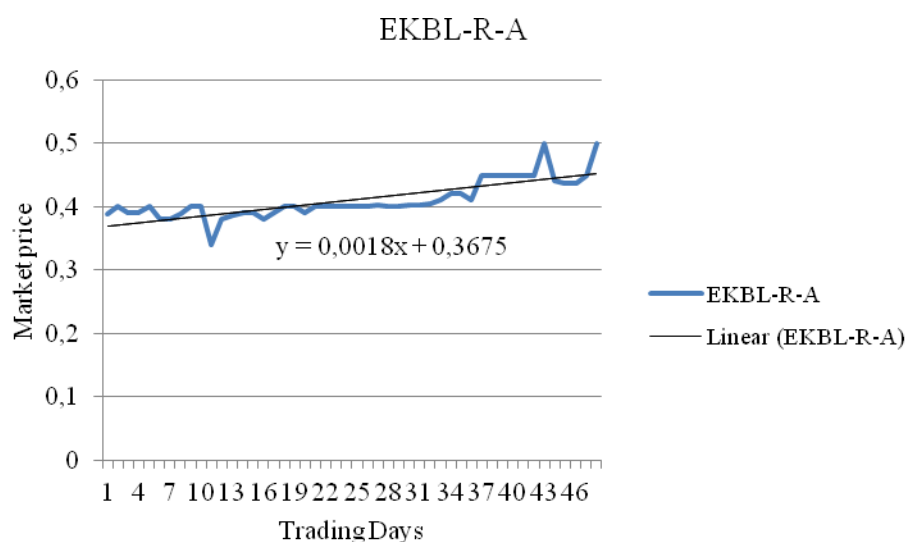

**Chart 5: Market price of “Elektrokraina” JSC Banja Luka (01.01.-31.12.2011)**

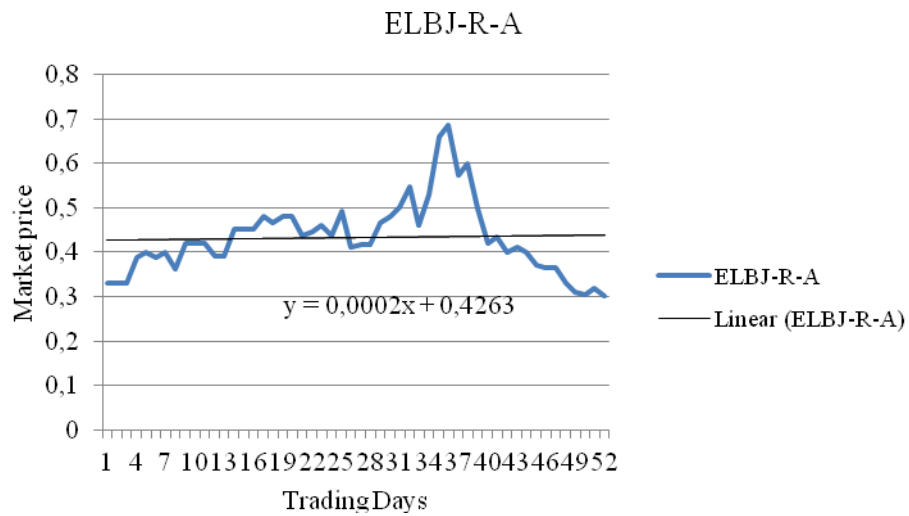

**Chart 6: Market price of “Elektro Bijeljina” JSC Bijeljina (01.01.-31.12.2011)**

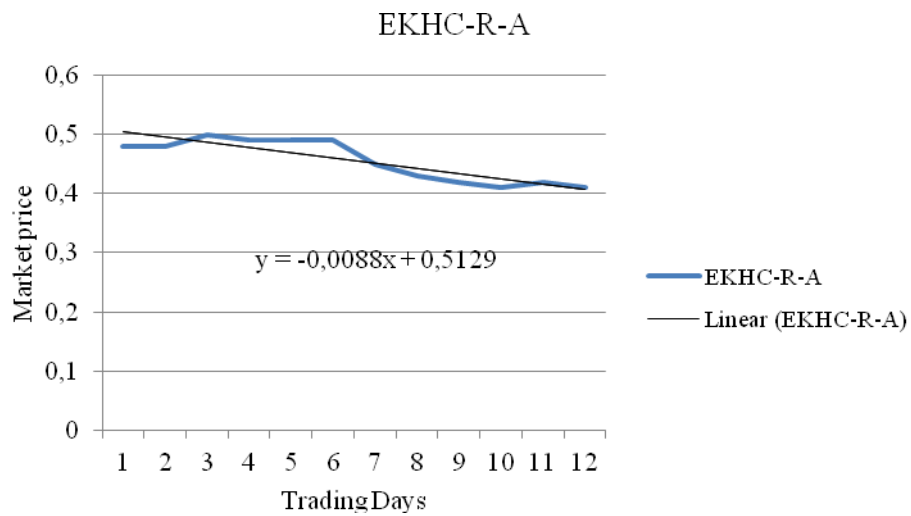

**Chart 7: Market price of “Elektrohercegovina” JSC Trebinje (01.01.-31.12.2011)**

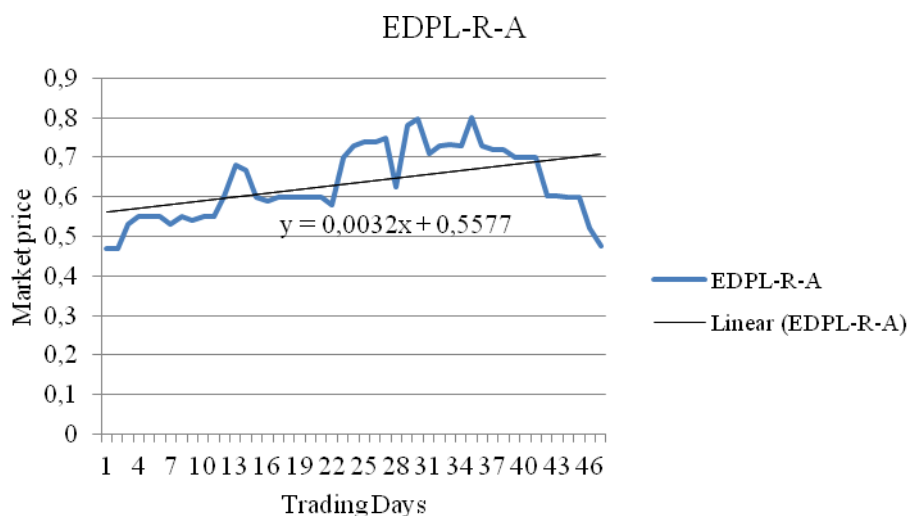

Chart 8: Market price of “Elektrodistribucija” JSC Pale (01.01.-31.12.2011)

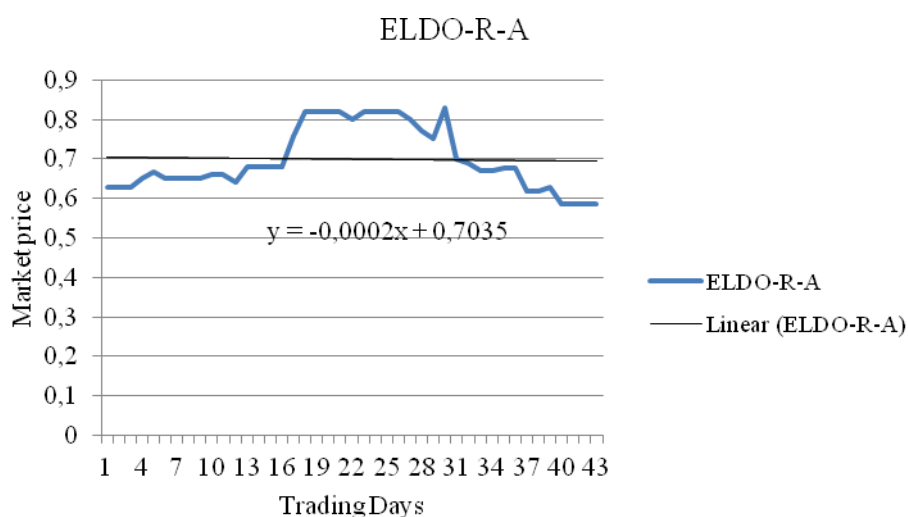

Chart 9: Market price of “Elektro Doboј” JSC Doboј (01.01.-31.12.2011)

Table 7: Market Prices (01.01.-31.12.2011)

Period 01.01.-31.12.2011	EKBL-R-A	ELBJ-R-A	EDPL-R-A	EKHC-R-A	ELDO-R-A
Min Market Price	0.341	0.302	0.470	0.410	0.586
Max Market Price	0.500	0.685	0.800	0.500	0.830
Average Market Price	0.411	0.432	0.634	0.456	0.699
Standard deviation	0.0305495	0.0824662	0.091091	0.0357919	0.0804287



The graph of index movements shows the negative trend. The negative trend is consequence of, in the average, the negative movements of market share price of 4 of 5 observed companies (also 5 other companies that are included in the calculation of the index, have the decline in the prices). If the risk is measured by standard deviation, it is obvious that “Elektrodistribucija Pale” JSC is the riskiest share, while risk of the “Elektrokrajina” JSC is below the average standard deviation which is a consequence of the narrow pricing spread (for example spread for “Elektrokrajina” JSC is 0.159, while for “Elektrodistribucija Pale” JSC is 0.33 with standard deviation of 0.091091). The same trend is followed by the “Elektrokrajina” JSC share price movements. It is obvious.

### Shareholder Return

**Table 8: Market Prices (01.01.-31.12.2011)**

	EKBL-R-A	ELBJ-R-A	EDPL-R-A	EKHC-R-A	ELDO-R-A
1. Dividend Payment	0	0	0	0	0
2. Average Share Number	92,276,622	38,486,953	15,795,899	20,048,466	31,117,961
3. Dividend per Share (1/2)	0	0	0	0	0
4. Market share price at the end of the period	0.388	0.330	0.470	0.480	0.630
5. Market share price at the beginning of the period	0.500	0.302	0.475	0.410	0.586
6. Capital Gain (4-5)	-0.112	0.028	-0.005	0.070	0.044
7. Total shareholder return (3+6)/5	-22.400%	9.272%	-1.053%	17.073%	7.509%

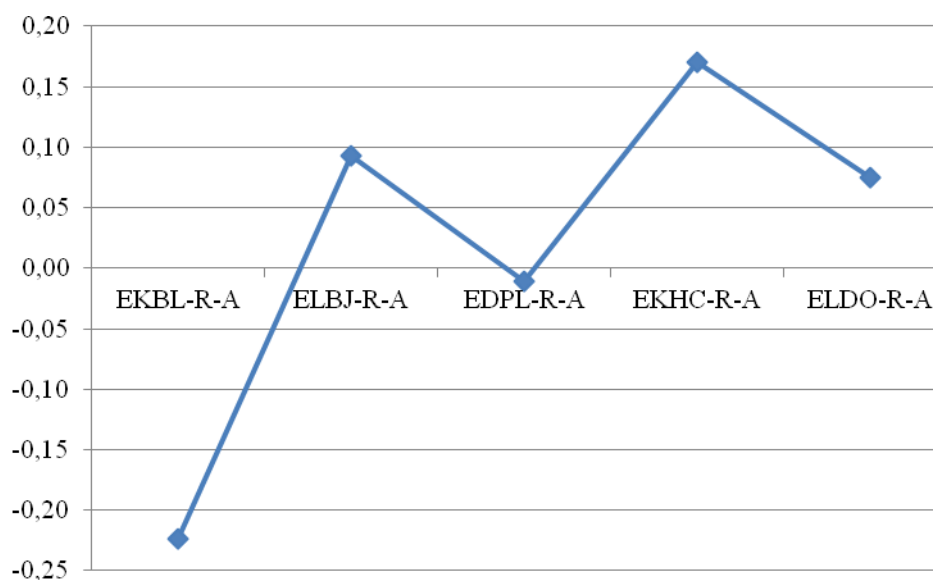

**Chart 10: Total Shareholder Return**

As it was previously mentioned, none of companies had not have dividend payments, so shareholder return consists only of the capital gain. The capital gain is calculated as the percentage of the change of the price between the end and the beginning of the period. Hence, it is assumed that ownership period is from the 01<sup>st</sup> of January until the 31<sup>st</sup> of December. The market prices of

“Elektrokrajina” JSC and “Elektrodistribucija Pale” JSC have decreased, while shareholders of other three joint stock companies have realized the capital gains.

***Customer analysis***

The distribution of electric power in Republic of Srpska is confined to the 5 observed companies. Each of the companies distributes electric power to the users in the particular municipality in the way that in one municipality there is only one distributor of electric power.

Our goal is to compare the data for “Elektrokrajina” JSC and the data for other companies concerning: the number of municipalities in the operating area, the number of consumers and the number of the biggest consumers.

Furthermore, we introduce the development coefficient as the mark of the wealth of the operating region. The development level of municipalities is revised annually and there are four stages:

1. Extremely underdeveloped (labeled with the development coefficient of 1),
2. Underdeveloped (labeled with the development coefficient of 2),
3. Moderately developed (labeled with the development coefficient of 3), and
4. Developed (labeled with the development coefficient of 4).

The label is credited to each municipality; after that the average label is calculated for each company.

**Table 9: Customer analysis**

	EKBL-R-A	ELBJ-R-A	EDPL-R-A	EKHC-R-A	ELDO-R-A
Number of Municipalities	17	13	15	6	8
Number of Consumers	230,842	100,057	51,808	27,159	89,002
Number of Consumers, the voltage level 110 kV	2	1	0	0	4
Number of Consumers, the voltage level 35 kV	3	7	7	1	14
Number of Consumers, the voltage level 10 kV	217	129	51	35	107
Average Municipality Development Coefficient	2.8235	2.4615	2.2667	2.6667	3.1250

“Elektrokrajina” JSC has the most consumers, moreover it has the most consumers whose the consumption voltage level is the highest. Also, the municipalities in the “Elektrokrajina’s” JSC operating area are the second by level of development, after “Elektro Doboje” JSC.

**Conclusion**

From the standpoint of justification investment decision for changing electricity meters in one of the five companies in the section: Electricity, gas and water supply, class: Distribution and trade of electricity in the Republic of Srpska, we have compared the financial values drivers of the company “Elektrokrajina” JSC Banja Luka to the financial values drivers of the other four companies. The purpose of the work is to represent how financial benchmarking is used to increase productivity, efficiency and achieve profit in companies dealing with distribution of electricity. Financial results of mentioned companies are directly related to the project of electric meters replacement, and in our

opinion, the best way to evaluate this investment project is through analyzing value drivers. Our intention was to use the financial benchmarking as a tool for making decision which company is the best for implementing above mentioned project.

Presented analysis of all financial value drivers demonstrates that company “Elektrokrajina” JSC Banja Luka is located, on the average, in the middle of the class. Compared with this company, “Elektro Bijeljina” JSC Bijeljina and “Elektro Dobož” JSC Dobož showed better indicators.

The indicators related to the income and profit for “Elektrokrajina” JSC Banja Luka is located on the average value of the class. Also, ratios bounded for the cash flow cash from operating activities are on the average of class. “Elektro Bijeljina” JSC Bijeljina has the negative ratios bounded for the cash flow cash from operating activities because of the net outflow of cash from operating activities. The best indicators in the class have “Elektro Dobož” JSC Dobož and “Elektrodistribucija” JSC Pale.

Ratios related to the liquidity and turnover for “Elektrokrajina” JSC Banja Luka are the lowest in the class. Further, short-term and long-term equilibrium are satisfied. The debt / equity ratio for the “Elektrokrajina” JSC is the highest in the class, as well as the obligation ratios. When it comes to the market indicators, they are below the average of the grade.

From the standpoint of solving the problem of electricity theft reduction, it is important to observe demand turnover ratios, where is apparent the number of trade receivables binding days is the highest for company “Elektrokrajina” JSC Banja Luka. Thus, the degree of receivables collectability is very high which, with major investment in the new electricity meters, would lead to the slow cash receivables of investments.

If only financial value drivers would be concerned by investment analyst, it had be better to implement the project of electric meters changing in the “Elektro Dobož” JSC as the company with the best financial indicators.

In order to accentuate the need for observing both financial and operative value drivers, we observed the operative value drivers, to find the base for decision of the holding “Elektroprivreda Republike Srpske” to entrust the pilot project of changing the electricity meters to “Elektrokrajina” JSC. Observing data concerning the number of consumers, the size of consumption, development of operating region of each company, from our point of view, the decision to start with a project in “Elektrokrajina” JSC is valid. For the reason of weak financial discipline in observed subject, parallel with the process of changing metrics, the new concept of financial managing in the company is needed, with the focus on the shortening of the receivables period.

## References

- Arnold, G. (1998). *Corporate Financial Management*. Financial Times. London: Pitman Publishing.
- Brooks, R. (2010). *Financial Management: Core Concepts*. London: Pearson Education.
- Codling, S. (1996). *Best Practice Benchmarking: A Management Guide*. Hampshire: Gover.
- Damodaran, A. (2005). *Corporate Finance – Theory and Practice*. New York: John Wiley & Son Inc.
- Đuričin, D. (2009). *Intelligentno upravljanje rizicima pomoću municipalnih obveznica*. Belgrade: NALED Conference, National Bank of Serbia, pp. 4-6.
- Đuričin, D. et al. (2010). *Menadžment i strategija*. Belgrade: CID Faculty of Economics.
- Đuričin, D. and D. Lončar. (2009). *Menadžment pomoću projekata*. Belgrade: CID Faculty of Economics.
- Young, M. (2004). *Readings in Management Accounting*. New Jersey: Prentice Hall.
- Krasulja, D. and M. Ivanišević. (2001). *Poslovne finansije*. Belgrade: CID Faculty of Economics.
- Parino, R. and D. Kidwell. (2009). *Fundamentals of Corporate Finance*. New York: John Wiley & Sons Inc.

## FINANCIAL BENCHMARKING: VALUE DRIVERS ANALYSIS

---

Resnick, E. (2004). *International Financial Management*. New York: The McGraw Hill Inc.

Rodić, J. and M. Filipović. (2010). *Poslovne finansije*. Belgrade: Belgrade business school – College of professional studies.

Smart, B. et al. (2007). *Corporate finance*, New Jersey: CENGAGE Learning (South Western).

Van Horne, J. (1992). *Financial Management and Policy*. New Jersey: Prentice-Hall Int.

### Online sources:

Đuričin, D. (2007). *Strateški menadžment pomoću usklađene liste*. 38. ERC. (26 June 2012).

<<http://www.ekof.bg.ac.rs/nastava/.../2009/HEC-1-Strategy1.ppt>>

*Banjaluka Stock Exchange. 2009*. BLSE. (26 June 2012) <<http://www.blberza.com>>

*Elektroprivreda Republike Srpske. 2012*. Elektroprivreda Republike Srpske. (26 June 2012) <<http://www.ers.ba>>

# THE GLOBALIZATION OF PROFESSIONAL ACCOUNTANTS EDUCATION AND THE ACHIEVED LEVEL IN SERBIA

Slobodan Malinić<sup>1</sup>

Vesna Janjić<sup>2</sup>

Mirjana Todorović<sup>3</sup>

**Abstract:** *Especially important aspect of national accounting regulation harmonization on the international and regional level concerns education and professional training of accountants, improvement of accountant's skills, as well as necessity for accountants continues education and licensing. In order to provide harmonization with international framework and requirements, especially in the field of professional accountant's education, Serbian national accounting regulation was extended with International Education Standards and IFAC code of ethics. With development of adequate institutional framework for education and professional development of accountants, a very important aspect of regulation harmonization is finished. But still, there is open question concerning implementation of regulation in practice and the Serbian accountant's education achievements. Hence, the goal of this paper is to identify the current status and prospects of accounting profession in Serbia, especially in the context of educational regulation globalization and harmonization. For these purposes and for the analysis, empirical results will be used.*

**Keywords:** *Globalization of accounting education, Accounting regulation, International Education Standards, Licensing of accountants.*

## Introduction

Demand for accountants has increased dramatically in the wake of financial disasters at Enron, MCI WorldCom, Tyco, and Arthur Anderson. Most of the new employees in 2005 in the USA were accountants (*National Association of Colleges and Employers - Wall Street Journal*). Additionally, the Bureau of Labor Statistics has predicted nearly 400.000 new accounting jobs over the 10-year period ending in 2012. Accounting is a very important profession, not only in the USA but all over the world and it is very interesting destination for hiring people.

Accounting information systems is the most important management information source and has the character of management subsystem. Of the total volume of available company information, as the most valuable resource of a modern company, about 40% of information comes from accounting. Information is not only numbers. Information is knowledge and the only right answer to the challenges of changes. Computers help in determining numbers, and even perform partial analysis, but only the right man with the right knowledge – an accountant, can and should use the existing knowledge in creation of information – knowledge for the purpose of managing. The survival and success of a company depend on decisions based on quality accounting information. Ensuring such information for the purposes of decision making and managing, for accounting is not a matter of choice. It is imperative.

Actually, everyone agrees that change in business is occurring rapidly, the need for professional accountants is growing and the role of accounting as an information source is invaluable. The real

---

<sup>1</sup> Faculty of Economics University of Kragujevac

<sup>2</sup> Faculty of Economics University of Kragujevac

<sup>3</sup> Faculty of Economics University of Kragujevac, mtodorovic@kg.ac.rs

## THE GLOBALIZATION OF PROFESSIONAL ACCOUNTANTS EDUCATION AND THE ACHIEVED LEVEL IN SERBIA

---

question is whether accounting organizations, professionals and educators are recognizing the changes and adapting quickly enough to the new environment. It seems that there is a certain imbalance, the ambivalence between the belief and attitude of professional accountants and accounting status as an academic discipline (Fisher and Murphy, 1995).

Also, while there appears to be consensus that the demand for accountants is on the rise, there is widespread concern that the gap between current accounting education and the needs of practice are widening (Davidson and Baldwin, 2005). Practice leaders are encouraging accounting educators to adopt an accounting curriculum that is more relevant and that focuses on real world situations. Almost two decades ago, the Accounting Education Change Commission (AECC) was created by the American Accounting Association (AAA) to serve as a catalyst to improve the academic preparation of future accountants. More specifically, the AECC's purpose was to move accounting education from the traditional transmittal of technical knowledge to the development of a "deep understanding of concepts and policies, as well as developing skills and attitudes necessary for the successful practice of accounting" (Gainen and Locatelli, 1995).

In the context of this problem, some authors emphasize the development of emotional intelligence of accounting students and the development of cognitive skills, especially teamwork, use of technology, exposure to global and ethical issues, and communication skills. Emotional intelligence (EI) may allow accountants to perform better in leadership, team building, client relations, and decision-making. Unfortunately, very little is known about the antecedents to emotional intelligence. However, there have been attempts to improve the emotional intelligence of university students through classroom exercises. It has also been suggested that work experience is instrumental in improving emotional intelligence. Students with more work experience will score higher in EI. Higher education, by itself, does not increase the EI of students. Thus, students may not be graduating from accounting programs with a level of EI adequate to meet the needs expressed by the professional organizations. Accounting educators should note that increasing EI of the students may require specifically targeted interventions (Cook et al. 2011). Akers and Porter (2003) go so far as to state that emotional intelligence skills (leadership, team building, interpersonal relations) are critical for the success of the accounting profession.

These findings clearly indicate the direction in which to create accounting curriculum for accountants, in what manner, with the use of which teaching and educational methods to implement them. That is, the extraordinary responsibility of educational institutions, especially universities and faculties. Faculties educate students for jobs that do not yet exist, for technologies that may not yet be invented in order to solve problems for which we do not even know whether they exist yet. In this connection it is interesting that 10 most wanted jobs in 2010 did not even exist in 2004 (*Secretary of Education, USA*). How can faculties respond to the dynamics of these changes, or do they have the capacity to adapt to the changed circumstances?

The good news is that, while the gap between education and practice has been widening, with quick and definitive action accounting education can be saved. There are many things that accounting educators do better than anyone else. In addition, there are many professional opportunities for which faculties can prepare graduates. However, accounting education cannot be saved by continuing to do the same things (Albercht and Sack, 2000). In some ways, the implications of change on education are obvious. Education institutions that are educating students to perform services that have been replaced by technology are finding that their students have a hard time finding jobs and that their student numbers are decreasing rapidly. Education institutions that have not adapted to change have found that many students who might have chosen accounting as a major in the past are now opting for more popular and highly paid information systems, finance, logistics/supply chain management, e-commerce, and strategy programs. Accounting professionals, who have adapted themselves, are telling that changes are neither fast nor substantive enough. The traditional model underlying accounting education no longer exists (Albercht and Sack, 2000).

As Freidson has noted, “the faculty of the professional school represents one of the major structural sources for sustaining professionalism.” Accounting educators help to sustain the accounting profession *as* a profession in at least two broad ways: The first is through our practice-related scholarship. Recall that a distinguishing feature of a profession is possession of bodies of specialized knowledge and practice skills (Freidson, 2001).

Bearing all this in mind, the aim of the study is to determine the current state and prospects of the accounting profession in Serbia, especially in the context of dynamic changes of contemporary environment, striving towards creating a knowledge society and necessary harmony in education of accountants in the international framework.

The remainder of the paper progresses as follows. In the next section, we will analyze the need for globalization of professional accounting education process and Serbian education systems. Then, we describe the research question and research methods used in the study. At the end we will present the results and conclude with a discussion of our findings and implications.

### **Globalization of professional accountants education**

Widely present globalization at all levels, in addition to the free movement of goods, capital and people on a global scale, requires compliance with a range of conditions and requirements. Hence, the globalization did not pass by the accounting and accounting profession. An important aspect of the globalization of contemporary business is the need for harmonization of accounting and financial reporting at the global level (Škobić, 2010), and the globalization of education accounting processes through their proper standardization.

The accounting profession, education and development of professional accountants are under very considerable influence of dynamic and continuing changes of the conditions and characteristics of global economy, i.e. the globalization and internationalization of business. Response to global demands and challenges is a duty and responsibility of many professions, especially accounting at all levels – local, regional, national and international. The ability to develop accounting as a profession depends on the ability and willingness of its individual members, professional accountants, to take responsibility to respond to these challenges. In order to meet these challenges, it is essential that professional accountants develop and achieve the necessary professional competence, but also to maintain it continuously by acquiring new accounting knowledge and skills, ethical values and principles, in accordance with global processes.

New knowledge, visions and ideas are preconditions of professional accounting knowledge of a high quality in the service of public interest. New visions and ideas should enable the development of a professional accountant with adequate and appropriate professional knowledge, skills, professional values, skills of critical thinking, creative thinking and ethical behavior. Global market needs new, globally oriented professional accountant, as a creator of accounting information and an active participant in the standardization and unification of financial reporting at the global level. Additionally, professional accountants should possess sophisticated skills of managers and analysts of complex financial and nonfinancial information.

The development and improvement of the accounting profession at global level is achieved within the mission of the International Federation of Accountants (IFAC). IFAC, in addition to great contribution to the standardization of financial reporting and/or audit, pays special attention to the standardization of the educational profile of professional accountant. That is, IFAC, with its mission of the world education improvement and development of professional accountants in order to protect public interest, has crucial and the most important role in changing the entire accounting profession.

## **THE GLOBALIZATION OF PROFESSIONAL ACCOUNTANTS EDUCATION AND THE ACHIEVED LEVEL IN SERBIA**

---

In order to implement the abovementioned mission, within IFAC, a special standing committee has been established, i.e. Educational Committee - EC, which is responsible and in charge of the adoption of international education regulation. EC was founded with the goal to globalize accounting education and development of accounting curriculum. That is, the EC mission is serving the public interest through the global promotion of education and development of professional accountants. Within the implementation of the EC mission three basic functions need to be fulfilled:

- Prescribing and establishing standards as a generally accepted good practice in education and development of professional accountants,
- Preparation of guidelines, interpretations, discussions, examples, in order for good practice to be prescribed more easily and prepared and implemented more efficiently and
- Resolving disputes, discovering new facts and solutions in researches, promotion of other important issues related to education and development of professional accountants (Malinić, 2006).

With the aim and for the purposes of the realization of these functions EC has adopted three types of statements:

- International Education Standards for Professional Accountants - IES,
- International Education Guidelines – IEG,
- International Education Papers - IEP.

In addition to these statements, within the IFAC are adopted the Code of ethics for professional accountants and Standards of the quality control of work and services of professional accountants. The additional documents are also significant and have an impact on the process of acquiring the title and continuing education of professional accountants.

The development of total international professional regulation, in the function of the globalization of professional accountant's education, has set up additional commitment and requirements to the accounting profession organized on a national level. In this regard, national professional education regulation of Serbia, before the adoption of International education standards, included the national accounting education standard ROS 31 – Accountants Professional Education (adopted in 1993). This standard, which is still in force, stipulates the conditions of accessing programs to acquire professional title in terms of the level of education and experience, assessment of professional competence for acquiring professional titles and establishing commitment and ways of performing continuing professional education and development. That is, the standard governs the professional training of accountants and acquiring professional titles. i.e. knowledge, skills, values, ethics and attitudes for self-bookkeeping, and preparation of financial statements for companies, banks, other financial organizations, nonprofit organizations, budget users and other legal entities.

Finally, the adoption of international education regulation and its incorporation into a national should enable the accounting profession at local, regional, national and international level:

- To take a leading role in a dynamic business environment which would preserve the status and reputation of the accounting profession,
- To convince the public of the competence of members of professional organizations in all areas of professional work and
- To assist users of financial statements and accounting services in identifying individuals who are capable of providing high quality professional services.



Bearing all this in mind it is necessary to further examine and analyze the specificities of the education of professional accountants in Serbia, aimed at considering the fulfillment of requirements set for the education globalization. For understanding the importance of the process of accounting education globalization, particularly important credit must be attributed to Serbian Association of Accountants and Auditors (SAAA). SAAA is trying, through cooperation with faculties of economics which provide basic academic education of future accountants and professional public, to make further efforts towards the development of professional accountants in Serbia.

### **The process of professional accountants education in Serbia**

University education of graduated economist-accountant in Serbia is conducted in 5 state Faculties of Economics, and in accordance with the Law on Higher Education, which supports the Bologna process, according to the modules or study programs for Accounting, Auditing and Financial Management. All faculties have accredited study programs and modules for all three study levels-Bachelor, Master and PhD studies where the dominating subjects are: Financial Accounting, Management Accounting, Cost Accounting, Auditing, Accounting Information Systems, Business Finance, Financial Reporting, Advanced Management Accounting and Performance Measurement.

In further education of professional accountants in Serbia, special place and role has the Serbian Association of Accountants and Auditors (SAAA). SAAA was founded in 1955 and as full and respected member of International Federation of Accountants (IFAC) it is recognized by 155 professional organizations of accountants and auditors from 118 countries worldwide. SAAA is a non-profit organization that gathers professional accountants from Serbia and is actively involved in the development of accounting profession, education of its members, and harmonization of essential interests of the profession with the total accounting regulation and best experiences of countries with developed accounting tradition.

SAAA, in accordance with its mission and objectives, organizes exam preparation and exam taking for acquiring professional titles in accounting in accordance with IFAC's International Education Standards (IES 1-8), IFAC's Ethical Codex for Professional Accountants (ECPA), Association of Chartered Certified Accountants program (ACCA) from the UK, the national education standard ROS 31, Rules for taking exams to acquire the professional title in accounting and Continuing education requirements for accountants.

In accordance with ROS-31 and the aforementioned regulations, the certification and licensing of three accounting titles is provided, and those titles are:

- Accountant, which requires a secondary school diploma, three years of experience in accounting jobs and passing nine exams on subjects required by the program,
- Certified Accountant, which requires completing post-secondary vocational degree (higher school) and four years of work experience or a faculty and three years of work experience, or with the previous title, also passing nine exams on subjects required by the program,
- Certified Public Accountant, which requires completing Faculty of Economics, the title of Chartered Accountant with three years experience in this profession, and passing five exams on subjects required by the program.

After acquiring these professional accounting titles, in order to obtain professional license to independently deal with this profession, the title holders are required to carry on continuing education, which is organized by SAAA, through the use of professional literature in practice (22 points), instructive education through seminars for the annual financial statement (12 points), theoretical and professional education through participation in symposium (22 points) and through seminars with

## THE GLOBALIZATION OF PROFESSIONAL ACCOUNTANTS EDUCATION AND THE ACHIEVED LEVEL IN SERBIA

---

independently treated current topics (6 points). The control of continuing education is performed by the SAAA Committee and certificate and license can be abolished by the decision of the Disciplinary Board pursuant to the regulations on disciplinary responsibility of professional accountants, or if it is proved that the title holder violated the IFAC's Ethical Codex for Professional Accountants (ECPA).

No doubt, that SAAA with its bodies: the Assembly, Executive and Supervisory Boards, Accountancy Board, Committee for Ethics and Education of Professional Accountants, Disciplinary Board and other bodies and agencies, has an important role in the processes of preparatory education, certification, especially in continuing education and licensing of professional accountants in Serbia. According to official records, the SAAA Register of professional titles, total number of SAAA members, by professional titles acquired until 23 January 2012, amounts to 31.498 members (Table 1) as follows:

**Table 1. The structure of SAAA members**

Accountant	15.232 member	48,4%
Independent Accountant	7.727	24,5%
Certified Accountant	8.239	26,1%
Certified Public Accountant	135	0,4%
Auditor	143	0,5%
Certified Auditor	42	0,1%
<b>Total</b>	<b>31.498</b>	<b>100%</b>

*Source: SAAA documents*

Also, from the SAAA Register of Professional Accountants, systematized information on continuing education of professional accountants, that is to say the number of licensed accountants, since 2000 is shown in the following Table 2:

**Table 2. The number of Serbian Certified Accountant's since 2000.**

Year	2000.	2001.	2002.	2003.	2004.	2005.	2006.	2007.	2008.	2009.
<b>Total</b>	<b>1.560</b>	<b>2.123</b>	<b>2.879</b>	<b>5.182</b>	<b>4.419</b>	<b>5.218</b>	<b>4.724</b>	<b>3.982</b>	<b>3.757</b>	<b>3.564</b>

*Source: SAAA Register of professional accountants education*

Important role in continuing education of professional accountants in Serbia also has the traditional SAAA Symposium, which has been held every year, since 1969, to be precise for 43 years. Report applicants are reputable accountants who work in the field, from national and international academic environment, as well as famous experts in the accounting practice of real, financial and public sector. Visitors, the audience at the Symposium, are actually certified and licensed professional accountants.

It is estimated that today, in Serbia, about 50.000 accountants are actively engaged in accounting jobs, which suggests the need for further more adequate education of professional accountants which will, among other things, be in the function of financial reporting quality.

## **The analysis of achieved level of accounting profession development in Serbia**

### ***Research question***

The general aim of the study is to determine the current state and prospects of the accounting profession in Serbia, especially in the context of dynamic changes of contemporary environment, striving towards creating a knowledge society and necessary harmony in accountants education in the international framework. Based on the overall aim, specific aims are performed.

In this regard, the aim is to determine the level of contemporary cost accounting systems understanding, particularly ABC and TDABC. In addition to establishing the level of understanding the aim is to determine the dependence of the level of these systems understanding on different responsibilities entities (factors) for the process of continuing education. Therefore, the hypothesis is:

**H1.** Accountants who attribute higher importance to faculties and professional associations of accountants, as well as their personal role (consider themselves personally responsible for continuing education) in the process of continuing education have higher level of understanding of contemporary cost accounting systems.

**H1.1.** Accountants who attribute higher importance to faculties in the process of continuing education have higher level of understanding of contemporary cost accounting systems.

**H1.2.** Accountants who attribute higher importance to SAAA in the process of continuing education have higher level of understanding of contemporary cost accounting systems.

**H1.3.** Accountants who attribute higher importance to their own responsibility in the process of continuing education have higher level of understanding of contemporary cost accounting systems.

The hypothesis testing will be based on the sample of 72 observations.

### ***Sample and methodology***

Since 1969 SAAA regularly organizes the Symposium of accountants in Zlatibor, as the most important gathering of professional and academic accountants in the country. This research was conducted in May 2011 during the three-day duration of the Symposium. The first day, during the registration of participants, 400 questionnaires were distributed. Ending with the third day 84 questionnaires were filled and delivered to researchers, which is about 21% of the total number of distributed questionnaires. Out of 84 received questionnaires, 12 were identified as inadequate and incomplete and were discarded in the analysis. The analysis included 72 questionnaires (i.e., observations), which is about 18%.

The questionnaire consisted of 30 questions, divided into three groups of questions. The first group of questions was related to the data concerning company's activity and size, accounting department, age and qualification structure of employees in the accounting department. Their purpose was primarily to describe the sample, to obtain descriptive information. The second group of questions was related to the knowledge of new accounting systems, i.e. the possession of innovative knowledge in the field of cost accounting methodology. The third group of questions concerned the participants' attitudes about continuing education. Particularly important aspect of the research included the questions regarding the attitude of respondents according to the responsibility for continuing education as follows: personal responsibility, SAAA and faculty responsibility. Defined responsibility is evaluated on a scale ranging from 1 to 5.

***Empirical results***

The accounting profession, education and development of professional accountants have a long history. At different stages of development the role and importance of the accounting profession are understood and treated differently. More than ever before, contemporary trends in the development of professional accountants expect new knowledge, visions and ideas based on the overall professional knowledge, especially high quality accounting knowledge in the service of public interest. The main goal of accounting education, lifelong learning and practical experience is, in accordance with the requirements of time, to create competent professional accountants, who will contribute to the profession, economic activity, development of economy and society in general.

Bearing in mind the overall aim set in this paper, first of all to determine the current situation, challenges and prospects of the accounting profession in Serbia, especially in the context of dynamic changes of contemporary environment, striving towards creating a knowledge society and necessary harmonization in the domain of accountants' education at the international level, we should first analyze and make description of the sample.

It has already been pointed out that the sample includes 72 observations. Of all respondents 75% were women and 25% male. The mean age was 50 years, to be precise even 43% of respondents have over 50 years and only 5,6% are younger than 30. According to the position in which they are engaged in the company 56,9% of respondents had a managerial position, and the rest 43,1% were not in a managerial position. In the structure of respondents the dominant were persons with academic degree, about 85%, and the rest was equally related to persons with secondary school degree and post-secondary vocational degree (see Figure 1).

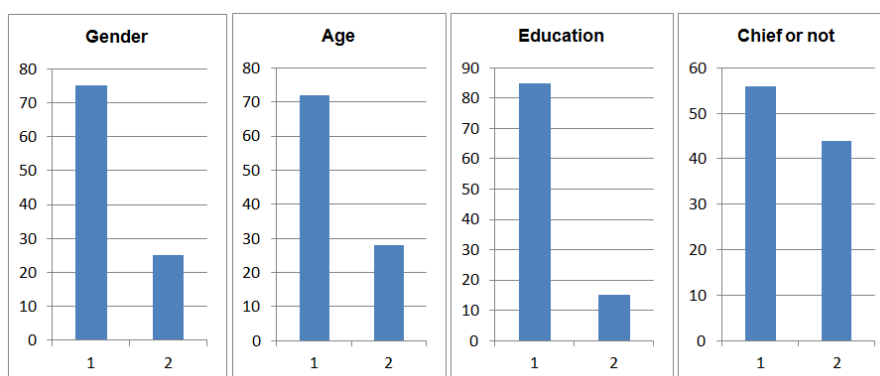

**Figure 1. Features of respondents**

*Source: own calculations.*

The aforementioned suggests that the average accountant in Serbia is a female, aged over 50, with academic degree. In addition, more than 50% of respondents are engaged in managerial positions in accounting and finance. The structure of companies, where respondents are employed, according to the size is as follows: 62,5% are large companies, 20,8% are medium-sized companies and 16,7% are small companies. In addition, 39% of respondents were employed in manufacturing companies and the rest almost equally in trade, banking, insurance, audit, consulting, public companies, etc. The subject of examination was the Accounting Department in these companies, specifically the number and age structure of employees in the department. Table 3 presents descriptive information for employee education structure.

**Table 3. Descriptive Statistics for Employee Education Structure in Accounting Departments**

	Obs.	Mean	Median	Standard deviation
Academic degree	72	18,32	14,64	17,65
Post-secondary vocational degree	72	31,59	28,99	23,33
Secondary school degree	72	50,07	52,27	25,02

Source: own calculations.

Table 3 shows that on average accounting department employs 18,32% of employees with academic degree, 31,59% with post-secondary vocational degree (higher) and 50,07% with secondary school degree. That means that on average majority of employees in accounting departments has lower degree education. Table 4 shows that on average the Chief of accounting department has academic degree, or 88,9%. Table 5 shows the education degree of accounting department chief concerning the size of enterprises.

**Table 4. Descriptive Statistics for Education of the Chief of Accounting Department**

	Obs.	Mean	Median	Standard deviation
Education of the chief of Accounting Department	72	2,83	3,0	0,50

Source: own calculations.

**Table 5. The Educational Structure of Accounting Department Chief**

Size of enterprises	Education degree of accounting department chief			
	Secondary	Post-secondary	Academic	TOTAL
Large	2,2%	2,2%	95,6%	100%
Medium	13,3%	6,7%	80,0%	100%
Small	8,3%	16,7%	75,0%	100%
TOTAL	5,6%	5,6%	88,9%	100%

Source: own calculations.

It is obvious that the majority of workers in management positions in companies of all sizes possess academic degree, as well as that the dominant participation in the structure of respondents have persons with academic degree and post-secondary vocational degree (higher). On the other hand, employees with secondary school degree have the dominant participation in the structure of employees in the accounting department in surveyed companies.

Continuing professional development is continuation of the education process after acquiring the title of qualified - professional accountant, which lasts through the entire professional career. IFAC and its members, and among others SAAA should promote the importance of continuing professional development, but also to allow accountants the access to programs and resources, as a kind of

## THE GLOBALIZATION OF PROFESSIONAL ACCOUNTANTS EDUCATION AND THE ACHIEVED LEVEL IN SERBIA

---

infrastructure necessary for continuing improvement. The Symposium, where this survey was made, had this for purpose.

In addition the questionnaire segment related to the familiarity of respondents with modern cost accounting systems did not give the expected results. We examined two contemporary cost accounting systems – Activity Based Costing and Time-Driven Activity Based Costing. ABC is a contemporary cost accounting system that has been created in the 80's of the 20th century, which is widely accepted around the world. TDABC, as a newer and more advanced version of ABC system, has developed over the last ten years with the aim to overcome the shortcomings of the traditional ABC. The results show that even 62,5% of respondents are not familiar with ABC system while 80,5% of respondents are not familiar with TDABC system, see Figure 2.

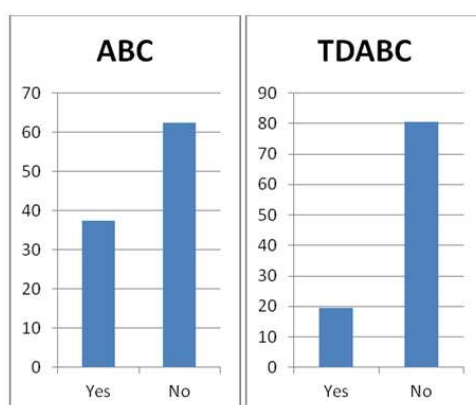

**Figure 2. Familiarity with cost accounting systems**

*Source: own calculations.*

Bearing in mind that out of the total number of respondents 56,9% were in a managerial position, and the rest 43,1% were not in managerial position, one can find interesting the analysis of the familiarity with contemporary cost accounting systems, according to their position at work. Even 40% of respondents in management positions were not familiar with the ABC system, i.e. majority of respondents who were familiar with this system are in non-managerial positions. Conclusions for TDABC system are identical. Low level of familiarity with contemporary cost management cost accounting systems require further analysis in terms of understanding responsibility for continuing education.

### **Analysis of the responsibility for continuing education**

The title holders are required to carry on continuing education in order to acquire professional accounting titles and licenses, in order to independently deal with the profession. According to the rules of SAAA four ways of realization of the education, i.e. achievement of a certain number of points, are defined. These are: the use of professional literature in practice (22 points), instructive education, through seminars, for the annual financial statement (12 points), theoretical and professional education through participation in symposium (22 points) and seminars by treating current themes independently (6 points). The focus of the research was theoretical and professional education through participation in the Symposium.

Respondents were asked to rate on a scale of 1 to 5 the importance of three aspects of responsibility for continuing education – faculty responsibility, SAAA responsibility and personal responsibility. Table 6 shows descriptive statistics for variables of faculty responsibility, professional associations' responsibility and personal responsibility.

**Table 6. Descriptive statistics for variables of faculty responsibility, professional associations' responsibility and personal responsibility**

	Obs.	Mean	Median	Standard deviation	Min.	Max.
Faculty responsibility	72	3,18	3,00	0,97	1,00	5,00
SAAA responsibility	72	3,68	3,00	1,14	1,00	5,00
Personal responsibility	72	4,09	5,00	1,09	1,00	5,00

Source: own calculations.

We test H1.1. by examining the connection between the evaluation of the importance of faculty responsibility for continuing education and familiarity with ABC and TDABC. Statistically, this connection will be identified using a chi-square. Since in the case of ABC systems  $X^2(1)=4,621$ ,  $p=0,328$  (and in the case of TDABC  $X^2(1)=3,962$ ,  $p=0,411$ ) we can conclude that there was no statistically significant connection between the evaluation of the importance of faculty responsibility for continuing education and familiarity with modern cost accounting systems, i.e. there is a very weak connection. This means that both groups of respondents (those who are familiar with the ABC and TDABC and those who are not) assign equal importance to the faculty responsibility for continuing education. It is found that on average most of those who are not familiar with the ABC and TDABC rate lower the importance of faculty responsibility for continuing education.

We test H1.2. by examining the connection between the evaluation of the importance of responsibilities of professional accountants' association (SAAA) for continuing education and familiarity of respondents with ABC and TDABC. Statistically, this connection will be identified using a chi-square. Since in the case of ABC systems  $X^2(1)=9,837$ ,  $p=0,043$  we can be conclude that there is a statistically significant connection between understanding and knowing the ABC system and the importance attached to the SAAA responsibility for continuing education. Accountants who attribute more importance to SAAA are significantly more likely to know about ABC. It is completely opposite situation related to the knowledge of TDABC, as tested connection is not statistically significant  $X^2(1)=4,590$ ,  $p=0,332$ .

An interesting tendency is noted, namely respondents who are familiar with ABC system, on average, attribute less importance to SAAA, as opposed to those who are not familiar and who attribute more importance to SAAA for continuing education. Or 33% of respondents who were unfamiliar with ABC on average rated highest SAAA responsibility, and only 12% of respondents who were familiar with ABC system on average rate higher SAAA responsibility. Most of the respondents, even 47%, those who are and those who are not familiar with the ABC system rated "3" the SAAA responsibility for continuing education.

We test H1.3. by examining the connection between evaluation of the importance of personal responsibility for continuing education and familiarity of respondents with ABC and TDABC. Statistically, this relationship will be identified using a chi-square. Since in the case of ABC system  $X^2(1)=4,967$ ,  $p=0,174$  (and in the case of TDABC  $X^2(1)=5,295$ ,  $p=0,151$ ) we can conclude that there

## **THE GLOBALIZATION OF PROFESSIONAL ACCOUNTANTS EDUCATION AND THE ACHIEVED LEVEL IN SERBIA**

---

was no statistically significant connection between the evaluation of the importance of personal responsibility for continuing education and familiarity with modern cost accounting systems, that is to say there is a very weak connection.

The data indicate that there is a low average rating (3,18) of faculty responsibility for continuing education; relatively high average rating (3,68) of SAAA responsibility for continuing education; and the highest average rating (4,09) of personal responsibility for continuing education processes.

Based on the lower rating of faculties responsibility for continuing education we can conclude that the role of faculties and universities in the process of continuing education is not understood properly. Also, it seems that in Serbia there is no necessary and sufficient awareness of the necessity to connect companies and educational institutions for the purposes of future development of professional accountants and improvement of the knowledge of existing professionals. Poor, underdeveloped cooperation and low level of connection is a significant limiting factor for the knowledge transfer, from academic to professional accountants. This is certainly one of the causes of low level of familiarity with modern cost accounting systems. However, the low level of knowledge of these concepts is not a consequence of respondent's individual responsibility or the companies or faculties, whose accounting curriculum should be more directed towards the creation of functional knowledge.

Since the percentage of respondents who are not familiar with ABC system (TDABC system) is very important and in a way it maintains the state of the accounting profession in Serbia, the question is how, with which measures and activities to improve the situation. Since personal responsibility is very highly rated, one of the possible measures can be the change of the structure of the rating system for continuing education by increasing the number of points that can be acquired through professional accountants' personal engagement. In addition, since the number of points which professional accountants can gain directly through the SAAA activities, possible improvement may be in the form of introducing new ways of the evaluation of professional accountants' engagement in the SAAA activities.

In any case, we cannot talk about individual responsibility of faculties, professional associations or individuals for continuing education, but about their common role and importance in the education process.

### **Conclusions**

In Serbia, there is no serious research on this subject. This project can therefore be described as a pioneer project. The authors are aware of possible restrictions, possible sample size and its specific structure, i.e. the dominance of highly educated and licensed accountants, then the possible weaknesses of the survey procedures and involvement and potential subjectivity of the authors concerning the implementation of the procedure.

Analysis of the data obtained by surveying on a sample of 72 observations clearly shows that:

- the average accountant in Serbia is a women with academic degree and aged over 50;
- in almost 89% of cases the chief of accounting department is a person with academic degree;
- more than 80% of employees in the accounting department of surveyed companies does not have an academic degree, i.e. the employees with secondary and post-secondary vocational degree are dominant;
  - the respondents on average annually visit 2 or 3 seminars in the field of additional continuing education, which respondents consider a sufficient number of seminars during one year;



- more than 62% of respondents are not familiar with ABC system (while more than 80% of respondents are not familiar with TDABC);
- the importance and role of faculty in the processes of continuing education is insufficiently understood;
- the role of SAAA and personal responsibility for the processes of continuing education are highly valued.

The results unequivocally confirm the unsatisfactory level of competence of the accounting profession, especially regarding the period until the beginning of this century and the significant improvements since the recognition and inclusion of SAAA in IFAC, and establishing cooperation with the ACCA and the immediate application of IFAC's IES and ECPA. Initiated reforms of the educational system in Serbia contribute to this positive trend, in accordance with the Bologna Declaration and Lisbon Convention supported by legal education regulation, including professional education and training of accountants, particularly the process of continuing professional education, and all in a function of the quality of financial reporting in Serbia and accounting profession globalization. Possible recommendations for further improvement and development of accounting profession in Serbia are:

- to increase the number of continuing education seminars,
- to organize different types of seminars customized to participants' qualifications, especially those intended for accountants of lower educational levels,
- to organize seminars for accountants employed in different sectors (real, financial, budgetary, etc.),
- to improve educational programs at all levels (secondary, post-secondary and academic) for the education of accountants;
- to strengthen the role of faculties in the processes of continuing education of professional accountants
- to strengthen cooperation between higher education institutions and economy, particularly in the area of mutual transfer of knowledge.

Creating accounting skills, knowledge and competences is a process of the highest and finest activities of accountants and an essential factor of the quality of accounting information system and financial reporting in general. Initiated reforms in the Serbian education system provide significant opportunities and commitments of permanent improvement of professional education system and training of accountants. Adopted international education regulation for professional accountants significantly contributes to the establishment of a harmonized high-quality accounting education and becomes an important starting point for the positive impact on the overall quality of the accounting profession.

## References

- Albercht, S. and R. Sack (2000). Accounting Education: Charting the Course through a Perilous Future. *Accounting Education Series*, 16, 1-68.
- Akers, M. D. and G.L. Porter (2003). Your EQ skills: Got what it takes?. *Journal of Accountancy*, 195(3), 65–70.
- Cook, G. et al. (2011). Emotional Intelligence: The Role of Accounting Education and Work Experience. *Issue in Accounting Education*, 26(2), 267-286.

## THE GLOBALIZATION OF PROFESSIONAL ACCOUNTANTS EDUCATION AND THE ACHIEVED LEVEL IN SERBIA

---

- Davidson, R. A. and B. A. Baldwin (2005). Cognitive skills objective in intermediate accounting textbooks: Evidence from end-of-chapter material. *Journal of Accounting Education*, April, 79-95.
- International Education Standards for Professional Accountants, IFAC – Education Committee, New York, 2008.
- Fisher, R. and V. Murphy (1995). A Pariah Profession? Some Students' Perceptions of Accounting and Accountancy. *Journal of Higher Education*, 9(1), 45-58.
- Freidson, E. (2001). *Professionalism: The Third Logic*. Chicago, IL: The University of Chicago Press.
- Gainen, J. and P. Locatelli (1995). Assessment for the new curriculum: A guide for professional Accounting programs. *Accounting education series*, 11, Sarasota, FL: American Accounting Association.
- Malinić, S. (2006). Međunarodna obrazovna regulativa za profesionalne računovođe, 37. Simpozijum: *Međunarodna profesionalna regulativa kao osnova kvaliteta finansijskog izveštavanja*, Beograd:SRRS, 127-140.
- ROS 31 – Profesionalno osposobljavanje računovođa, Glas računovođa 13-14/2009., Beograd:SRRS.
- Škobić, P. (2010). Globalizacija edukacije profesionalnih računovođa i praksa u Srbiji. *Računovodstvo* 1-2, 24-42.

**QUANTITATIVE METHODS AND MODELS  
IN ECONOMICS AND MANAGEMENT**



# THE EUROPEAN QUALIFICATION FRAMEWORK AS A BASE FOR STUDY PROGRAM MODELLING AND ANALYSIS

Paweł Lula<sup>1</sup>

**Abstract:** *In the paper the model of the study program was proposed. The model was inspired by the European Qualification Framework (EQF) and consists of three components related to knowledge, skills and competences (section 1 and 2). In EQF the crucial role is played by learning outcomes which are used to define and compare educational programs (section 3 and 4). All these aspects are taken into account in the hierarchical model which is presented in the section 5. Exemplary application of the model are shown in section 6.*

**Keywords:** *European Qualification Framework, study program modelling and analysis, learning outcomes, comparative analysis of study programs*

## New solution in higher education in Europe

For last fifteen years a new system of higher education in Europe has been developed. This process was formally launched in 1999 with signing the Bologna Declaration by Education Ministers from 29 European countries. In the document two main goals were appointed: harmonization of higher education systems and quality assurance. Also three cycles of higher education were introduced: bachelor, master and doctoral study. European Credit Transfer and Accumulation System (ECTS) considerably increased students' mobility between different countries.

In order to harmonize all levels of education systems in different countries the European Qualification Framework (EQF) was adopted by the European Parliament in 2008 (Recommendation of the European Parliament and of the Council on the establishment of the European Qualifications Framework for lifelong learning , 2008). EQF introduced the reference model with eight levels of education. For every level learning outcomes were defined. EQF model allows to compare different national solutions and transfer educational achievements from one country to another. Every European country should assign its own educational institutions to the proper level of the EQF model.

In European Qualification Framework the descriptions of learning outcomes have fundamental importance. Two education institutions can be found comparable if they assure similar results (learning outputs). EQF introduced three types of learning outcomes:

- learning outcomes related to knowledge,
- skills,
- competences.

Diversity of national educational systems causes that the EQF model can work properly only if quality assurance policy is obeyed. It should be checked if:

- learning outcomes which are defined for educational institutions are comprehensive and consistent with general goals which should be obtained at the given level of education system
- learning outcomes are compatible with labour market demands,

---

<sup>1</sup> Faculty of Management, Cracow University of Economics, pawel.lula@uek.krakow.pl

- educational programs which are carried out by educational institutions are consistent with learning outcomes.

Quality assurance policy is not implemented into the European Qualification Framework. It should be designed and implemented in solutions which exist at the national levels and which are adopted by universities and schools.

Higher education is represented in the European Qualification Framework by three levels:

- bachelor programs corresponds to the 6<sup>th</sup> level of the EQF,
- master programs are represented by the 7<sup>th</sup> level,
- doctoral studies accords with the 8<sup>th</sup> level of the reference model.

### **Learning outcomes for higher education**

#### ***Learning outcomes related to knowledge***

According to the EQF knowledge is the body of facts, principles, theories and practices that is related to a field of work or study.

At the 6<sup>th</sup> level educational institutions should deliver advanced knowledge of a field of work or study involving a critical understanding of theories and principles.

The European Parliament Recommendation also defines two learning outcomes relevant to knowledge at the 7<sup>th</sup> level of educational system:

1. highly specialized knowledge, some of which is at the forefront of knowledge in a field of work or study, as a basis for original thinking and/or research.
2. critical awareness of knowledge issues in a field and at the interface between different fields.

Analogical statement for learning outcomes related to knowledge at the 8<sup>th</sup> level is the following: knowledge at the most advanced frontier of a field of work or study and at the interface between fields.

#### ***Skills***

Skills are defined as the ability to apply knowledge and use know-how to complete tasks and solve problems. Skills are divided into two groups:

- *cognitive* – involving the use of logical, intuitive and creative thinking,
- *practical* – involving manual dexterity and the use of methods, materials, tools and instruments.

Learning outcomes related to skills at the 6<sup>th</sup> level were described as: advanced skills demonstrating mastery and innovation, required to solve complex and unpredictable problems in a specialised field of work or study.

Definition for the 7<sup>th</sup> level is the following: specialised problem-solving skills required in research and/or innovation in order to develop new knowledge and procedures and to integrate knowledge from different fields.

Outcomes relevant to skills at the 8<sup>th</sup> level of education system are defined as: the most advanced and specialised skills and techniques, including synthesis and evaluation, required to solve

critical problems in research and/or innovation and to extend and redefine existing knowledge and professional practice.

### *Competences*

The third types of learning outcomes are competences which are defined as the proven ability to use knowledge, skills and personal, and/or methodological abilities, in work or study situations and in professional and personal development. In the context of EQF, competence is described in terms of responsibility and autonomy.

At the 6<sup>th</sup> level of education system two learning outcomes related to competences are mentioned:

- manage complex technical or professional activities or projects, taking responsibility for decision-making in unpredictable work or study contexts,
- take responsibility for managing professional development of individuals and groups.

EQF also defines requirements for competences at the 7<sup>th</sup> level of education:

- manage and transform work or study contexts that are complex, unpredictable and require new strategic approach,
- take responsibility for contributing to professional knowledge and practice and/or reviewing the strategic performance of teams.

Learning outcomes related to competences and to the 8<sup>th</sup> level of education are defined as: demonstrate substantial authority, innovation, autonomy, scholarly and professional integrity and sustained commitment to the development of new ideas or processes at the forefront of work or study context including research.

### **Three-dimensional model of learning outcomes for higher education**

#### *Model of knowledge-related outcomes*

Presentation of the fields of study and relationships between them is the main goal of the model of knowledge. In this approach Joint Academic Coding System (JACS) Version 3.0 was used (Joint Academic Coding System (JACS) Version 3.0, 2012). This model is used in the United Kingdom and was proposed by Universities and Colleges Admissions Service (UCAS) and the Higher Education Statistics Agency (HESA).

JACS model has a hierarchical structure. Descendants of the root element (which corresponds to the knowledge as a whole) represent main groups of fields of study. These groups are tagged by letters. The list of main groups is showed on the Table 1.

**Table 1. Main groups of the fields of study in JACS model.**

<b>Letter</b>	<b>Subject Group</b>
A	Medicine and Dentistry
B	Subjects allied to Medicine
C	Biological Sciences
D	Veterinary Sciences, Agriculture and related subjects
F	Physical Sciences
G	Mathematical and Computer Sciences
H	Engineering
J	Technologies
K	Architecture, Building and Planning
L	Social studies
M	Law
N	Business and Administrative studies
P	Mass Communications and Documentation
Q	Linguistics, Classics and related subjects
R	European Languages, Literature and related subjects
T	Eastern, Asiatic, African, American and Australasian Languages, Literature and related subjects
V	Historical and Philosophical studies
W	Creative Arts and Design
X	Education
Y	Combined studies
Z	Not used

Source: [http://en.wikipedia.org/wiki/Joint\\_Academic\\_Classification\\_of\\_Subjects](http://en.wikipedia.org/wiki/Joint_Academic_Classification_of_Subjects)

For example *economics* as a field of study is located in *social studies* (group L) and is divided to following categories:

- L100 Economics
- L110 Applied economics
- L111 Financial economics
- L112 Agricultural economics
- L113 Economic policy
- L120 Microeconomics
- L130 Macroeconomics
- L140 Econometrics



- L150 Political economics
- L160 International economics
- L170 Economic systems
- L171 Capitalism
- L172 Monetarism
- L173 Keynesianism
- L174 Collectivism
- L190 Economics not elsewhere classified

If it would be necessary for specialisation representation further levels of tree can be added. The JACS model of fields of study is common for all three stages of higher education. In further parts of the text the following symbols are used:

- *fosTree* – represents a whole tree of study fields,
- *fosNode* – represents one node in the *fosTree*.

Also it is assumed that the function *fosTree.dist* is defined which computes a distance between two fields of study (represented by *fosNode* elements). The header of the *fosTree.dist* function can be presented as:

```
fosTree.dist(x, y: fosNode): real
```

### ***Model of skills***

It is proposed to represent learning outcomes related to skills by a tree model. The root of the tree represents the concept of skills. Its descendants represent different forms of skills (The referencing document of the Dutch National Qualification Framework to the European Qualification Framework, 2012):

- *Applying knowledge* Reproduce, analyse, integrate, evaluate, combine and apply knowledge in an occupation or a knowledge domain
- *Problem solving skills* Recognise or identify and solve problems
- *Learning and development skills* Personal development, autonomously or under supervision
- *Information skills* Obtain, collect, process, combine, analyse and assess information
- *Communication skills* Communicate based on conventions relevant to the context

These general types of skills can serve as base concepts for further, more detailed subtypes.

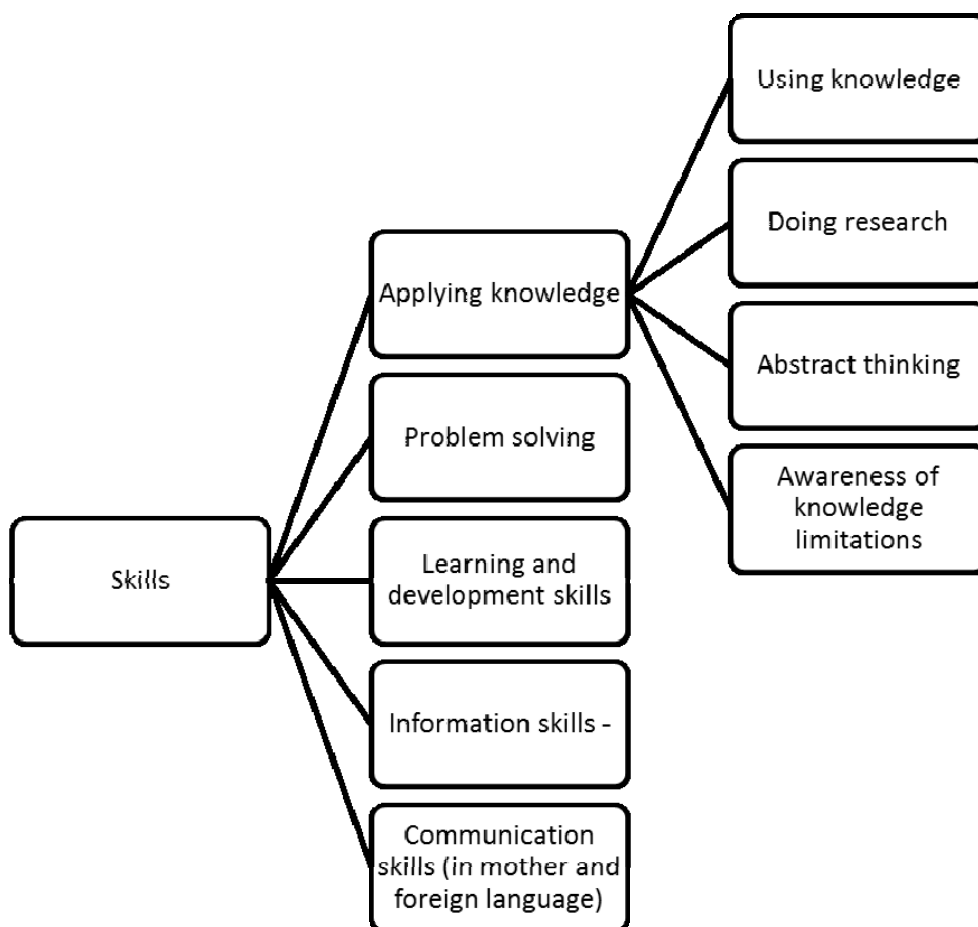

**Fig. 1. The structure of skills. Source: own elaboration based on (The referencing document of the Dutch National Qualification Framework to the European Qualification Framework, 2012)**

In the following sections of the paper the tree model of skills is identify by *skillsTree*. Nodes of the *skillsTree* are represented by *skillsNode* elements. A function *skillsTree.dist* is defined:

```
skillsTree.dist(x,y: skillsNode): real
```

which calculates distance between two *skillsNode* elements.

Taking into account different expectations assigned to consecutive levels of education it is advisable to focus on different goals of education process carried out at each level of education.

### ***Model of competences***

Also competences can be showed as a tree. In the model which is used here two main competences were underline: collaboration with other people and responsibility for oneself and others (Fig. 2).

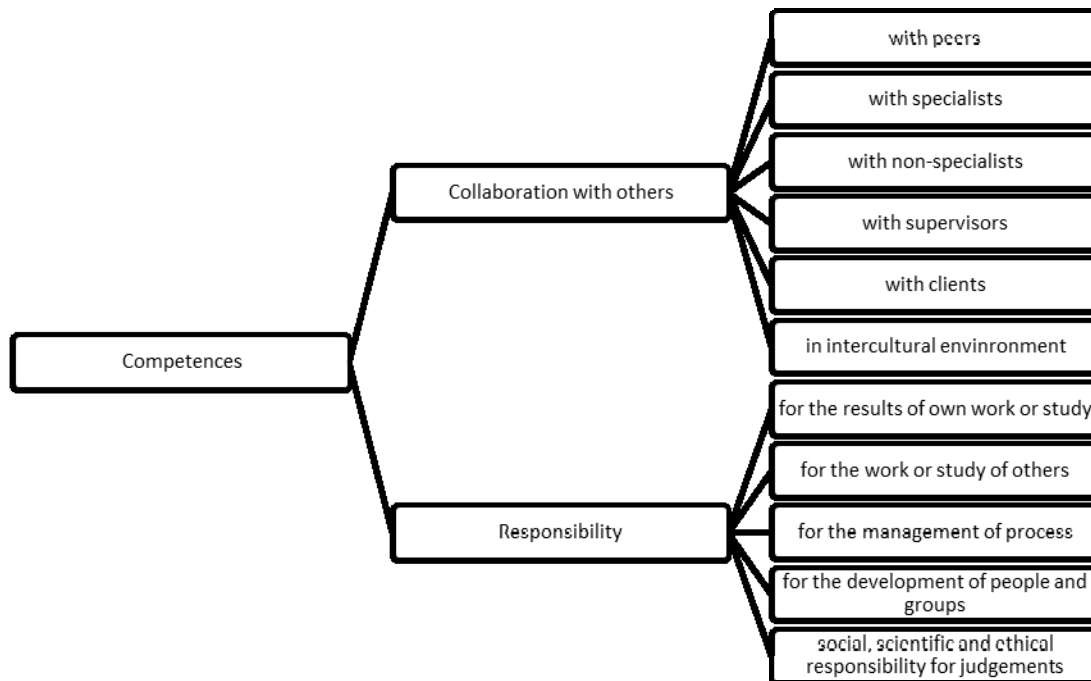

**Fig. 2. The structure of competences. Source: own elaboration based on (The referencing document of the Dutch National Qualification Framework to the European Qualification Framework, 2012)**

The structure of competences is available as a *competencesTree* object. The *competencesNode* represents one element of the tree. Also a function:

```
competencesTree.dist(x, y: competencesNode): real
```

is defined. It returns a distance between two competences represented by *competenceNode* elements.

### The hierarchy of learning outcomes in national qualification frameworks

Taxonomies showed in the previous section show knowledge, skills and competencies at different levels of generality. In all cases, in trees representing these concepts, descendant nodes specify concept which has narrowed meaning than its ancestors. In countries which implemented solutions based on EQF also another hierarchy of learning outcomes can be observed. It is possible to distinguish outcomes defined for fields of study (domain outcomes), for study programs (program outcomes) and for courses (course outcomes).

Such structure of outcomes also exists in Poland. Domain outcomes are defined by the ministry who is responsible for higher education. Senates of universities enact learning outcomes for study programs. Faculty Councils are responsible for defining learning outcomes related to courses (Fig. 3).

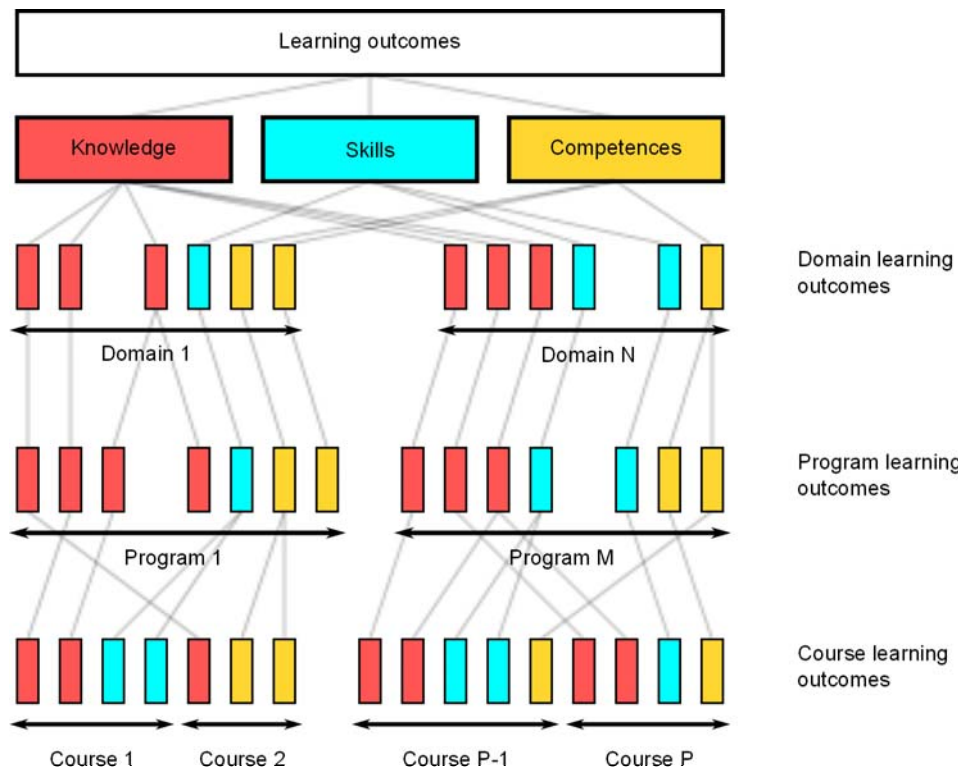

**Fig. 3. The structure of learning outcomes for higher education institutions in Poland.**  
Source: own elaboration

### Model of study program

The model which is presented in the current section has a conceptual character and is presented in pseudocode. However the level of abstraction is close to it which is used for data structure and algorithms description in general-purpose programming languages. Therefore it is relatively easy to implement the model as a computer program.

Learning outcomes are represented by CLO (course learning outcomes), PLO (program learning outcomes) and DLO (domain learning outcomes) types.

The definition of one course learning outcome is defined as:

CLO:

- refToPLO // reference to PLO object
- type // one from {KNOWLEDGE, SKILLS, COMPETENCES}
- refToFosNode // reference to fosNode
- refToSkillsNode // reference to skillsNode
- refToCompetenceNode // reference to competencesNode

It is assumed that every CLO object has a reference to the proper PLO object. All learning outcomes are related to knowledge, skills or competences. Also they have references to nodes located

in *fosTree*, *skillsTree* and *competencesTree*. But only one of them has a non-empty value. For outcomes related to knowledge the value of *refToFosNode* is crucial (the remaining references are empty). For skills-related outcomes *refToSkillsNode* plays important role. At last for outcomes describing competences *refToCompetencesNode* is essential. It is assumed that all these values are set during creation of *CLO* object.

Below the structure of the program learning outcome is presented:

PLO:

- *refToDLO* // reference to DLO object
- *type* // one from {KNOWLEDGE, SKILLS, COMPETENCES}
- *refToFosNode*
- *refToSkillsNode*
- *refToCompetencesNode*

The definition of domain learning outcome is the following:

DLO:

- *type* // one from {KNOWLEDGE, SKILLS, COMPETENCES}
- *refToFosNode*
- *refToSkillsNode*
- *refToCompetenceNode*

Domain learning outcomes have no reference to upper outcomes.

The study program is represented by *STUDYPROGRAM* structure. It is defined as follows:

STUDYPROGRAM:

- *plo* = set of (PLO)
- *semesters* = list of (SEMESTER)

It is a complex structure which has two fields. A *plo* is defined as a set of *PLO* elements (a set of objects representing program learning outcomes). A *semesters* element is defined as a list of *SEMESTER* objects.

*SEMESTER* is a set of courses. It is defined as:

SEMESTER:

- *courses* = set of (COURSE)

One course is modelled by *COURSE* structure:

COURSE:

- *clo* = set of CLO
- *topics* = list of TOPIC

## THE EUROPEAN QUALIFICATION FRAMEWORK AS A BASE FOR STUDY PROGRAM MODELLING AND ANALYSIS

---

- `numberOfHour` // of a whole course; an integer value

In a course description *clo* represents a set of course learning outcomes. A full content of the course is given by a list of *TOPIC* elements:

TOPIC:

- `description` // of the topic; a string value
- `refToFosNode`
- `refToSkillsNode`
- `refToCompetencesNode`
- `numberOfHours` // for a given topic; an integer value

Every *TOPIC* has references to the models of knowledge, skills and competences. Of course, not always all these references are set (if a given topic does not deliver some types of outcomes the corresponding references are left empty).

### Program analysis

One of the most important features of the proposed model is support for the quality assurance policy. Every changes in study program should be based on the results of profound analysis.

Let *sp* be a *STUDYPROGRAM* structure with a complete definition of the study program.

#### *The structure of the study program*

The structure of study program taking into account the types of learning outcomes can be calculated by the algorithm presented below:

```
for each s in sp.semesters
  for each c in s.course
    for each t in c.topics {
      calculate:
        topicNoH.Knowledge, TopicNoH.Skills,
        TopicNoHCompetences
    }
    calculate:
      courseNoHKnowledge, CourseNoHSkills,
      TopicNoHCompetences
  }
  calculate:
    semesterNoHKnowledge, semesterNoHSkills, semesterNoHCompetences
}
calculate:
  programNoHKnowledge, programNoHSkills, programNoHCompetences
```

The above algorithm allows to calculate what percentage of time is allocated for knowledge-related, skills-related and competences-related goals. This calculation can be done for courses, semesters and a full study program.

**Coverage analysis**

Coverage analysis of study program shows the distribution of learning hours over given quality feature (for example fields of study or type of skills or competences). If a quality feature has a hierarchical structure it can be convenient to present results of the analysis as a hierarchy table. Each cell should contain a label, cardinality and a cumulative cardinality (sum of the cardinality of the current cell and cardinality of all cells located below in the tree structure). The results of exemplary coverage analysis is presented on Fig. 4.

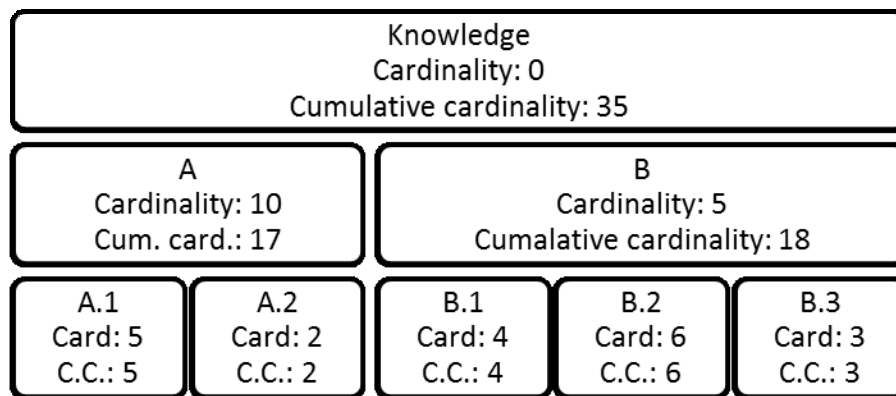

**Fig. 4. Results of exemplary coverage analysis. Source: own elaboration.**

The results of the coverage analysis show which learning outcomes are carried out by the study program and in what extent.

**Generality level of the course**

The generality level of a course can be defined as an average distance between topics discussed during the course divided by the average distance between topics calculated for the whole study program (or other group of courses). It may be formulated as:

```

for each c in [set of course]
  for each t in c.topics
    calculate:
      average distance between topics
    
```

The generality level can be defined for knowledge, skills or competences-related goals.

Also other measures for distances between topics can be calculated. For example: maximum or minimum distance, variance, standard deviation or median value.

*Comparative analysis of courses*

Comparative analysis of two courses can be performed taking into account their content related to knowledge, skills or competences. The tree model of the selected aspect is the base of the analysis. At the first stage of comparison two distributions of hours over nodes of the chosen tree are calculated. The results have a form of weighed tree (with weights assigned to nodes). Between them the similarity measure should be calculated.

The similarity measure of two courses can be calculated with the help of modified version of the Jaccard index. The Jaccard index is used for calculation a similarity measure between sets and is defined as:

$$J(A,B) = \frac{|A \cap B|}{|A \cup B|}$$

For weighted trees cardinality of sets is determined by values assigned to nodes.

During analysis two problems can appear.

The first one is related to the location of nodes being compared. The differences at the higher level of the tree should strongly influence the distance between trees. In order to address this demand weights can be used which will take smaller values with the movement to the lower levels of the tree.

The second problem concerns the differences in the level of generality of concepts used in the descriptions of topics discussed during the course. Consider the situation shown in the Fig. 5. In the first course 4 hours are assigned to the node A and no hours to nodes located below node A. In the second course only one hour is assign to the node A and 4 hours do different descendants of the node A.

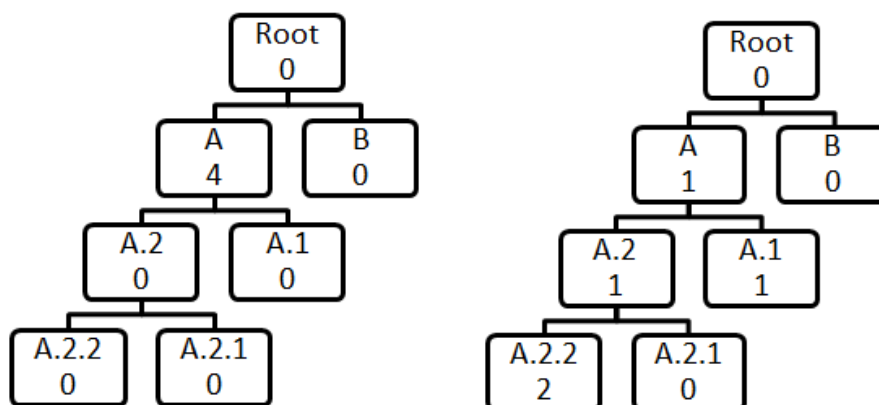

**Fig. 5. Two exemplary trees with the distribution of hours. Source: own elaboration.**

There are many ways to solve this problem. The solution may be distribution of hours assign to the node to all nodes lying between the root and the current element. Of course, the appropriate system of weighting should be used. For example, if weights are calculated according to the formula  $2^{i-1}$  (where  $i$  represents the level of the node) above presented trees will have a form showed on Fig. 6.



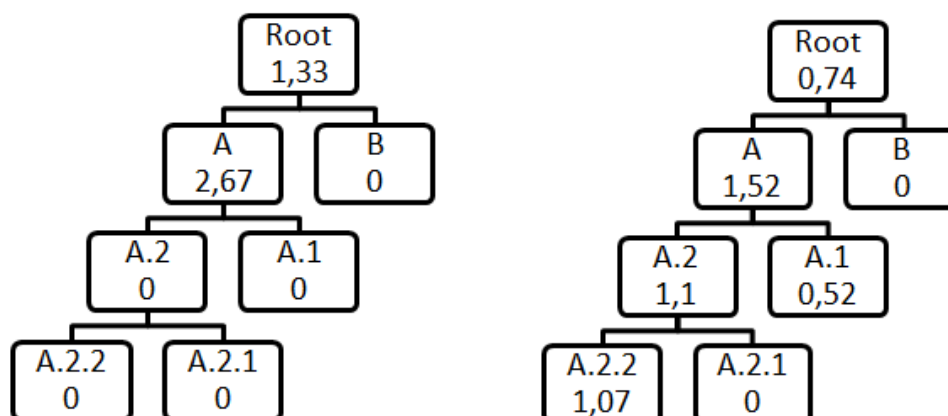

**Fig. 6. Two exemplary trees with the modified distribution of hours. Source: own elaboration.**

### *Comparative analysis declared learning outcomes and the content of the lecture*

The method proposed for comparative analysis of the content of two courses can be used to compare declared learning outcomes and content of the lecture. In this case one tree will represent learning outcomes, while the second will correspond to the lecture content. It should be taken into account that the learning outcomes are usually defined on the more general level than the content of the lecture. Therefore before comparison an aggregation may be done in the tree representing the lecture. This tree is pruned to the size of the tree representing learning outcomes. Values from removed nodes are summed and assign to the lowest remaining node.

### **Conclusion**

European Qualification Framework is not only a tool for harmonization of education systems in different countries. It is also a perfect base for the analysis of educational programs. The appropriate tools allow to discover the structure and the scope of educational programs. Also comparative analysis may be conducted.

Analysis shown in the paper have exemplary character. The possibilities of the proposed approach are practically limitless.

### **References**

- Recommendation of the European Parliament and of the Council on the establishment of the European Qualifications Framework for lifelong learning* . (2008, April 23). Pobrano 08 15, 2012 z lokalizacji <http://eur-lex.europa.eu/LexUriServ/LexUriServ.do?uri=OJ:C:2008:111:0001:0007:EN:PDF>
- Joint Academic Coding System (JACS) Version 3.0*. (2012). Pobrano 08 15, 2012 z lokalizacji <http://www.hesa.ac.uk/content/view/1776/649/>
- The referencing document of the Dutch National Qualification Framework to the European Qualification Framework*. (2012, February). Pobrano 08 15, 2012 z lokalizacji [http://ec.europa.eu/education/lifelong-learning-policy/doc/eqf/nederland\\_en.pdf](http://ec.europa.eu/education/lifelong-learning-policy/doc/eqf/nederland_en.pdf)



# STOCK MARKET INDEX FORECASTING USING NEURAL NETWORK MODELS: STUDY OF BELGRADE STOCK EXCHANGE

Zoran Kalinić<sup>1</sup>

Zora Arsovski<sup>2</sup>

Vladimir Ranković<sup>3</sup>

Igor Milanović<sup>4</sup>

Dragana Rejman Petrović<sup>5</sup>

**Abstract:** *The forecast of stock prices and indices is an important issue in financial markets. This problem is highly non-linear and difficult to be modeled by conventional techniques, and the application of artificial intelligence, especially neural networks, is often investigated as a possible solution. In this paper, feedforward back-propagation neural network is used for the forecasting of one-day-ahead value of BELEX15, the main index of Belgrade Stock Exchange. Taking in mind that the financial world is global, as input variables for the network, beside local financial indicators such as previous values of the index and RSD/EUR exchange rate, some global financial indicators, such as the indices of the main world stock markets and EUR/USD exchange rate, were also used. The results of prediction simulation show that neural network models can be useful tools in forecasting stock exchange movements.*

**Keywords:** *neural network, stock market, stock exchange index, prediction, forecast*

## Introduction

Artificial intelligence techniques are nowadays very often used in many problems in business and finance, and one of the most popular and useful methods are artificial neural networks (ANN). ANN has been shown to be a very efficient tool for non-parametric data modeling in variety of different contexts and complex systems where the output is a non-linear function of inputs (Dutta et al. 2006, Faria et al. 2009). They are robust, less sensitive to error term assumptions and they can tolerate noisy, chaotic components better than other methods. Although they are sometimes criticized because of the black box nature of their solutions, excessive training times, difficulty in obtaining and later replicating stable solution, etc. (Kaastra and Boyd 1996), neural networks are one of the most often used artificial intelligence techniques, applicable in many research areas. Typical applications in finance include business forecasting, credit scoring, stock market forecasting, bond rating, business failure prediction, bankruptcy forecasting, exchange and interest rate prediction, stock return risk rating of mortgages and fixed income investments, index construction, simulation of market behavior, portfolio selection/diversification, and many others (Kaastra and Boyd 1996; Dutta et al. 2006; Yildiz et al. 2008).

---

<sup>1</sup> Faculty of Economics, University of Kragujevac, zkalinic@kg.ac.rs

<sup>2</sup> Faculty of Economics, University of Kragujevac

<sup>3</sup> Faculty of Economics, University of Kragujevac

<sup>4</sup> Faculty of Economics, University of Kragujevac

<sup>5</sup> Faculty of Economics, University of Kragujevac

## STOCK MARKET INDEX FORECASTING USING NEURAL NETWORK MODELS: STUDY OF BELGRADE STOCK EXCHANGE

---

The ability to predict future trends interests many people. On stock markets, predictions of stock prices and indices are very important in making buy and sell decisions (Chaigusin et al. 2008). The increasing globalization of the financial markets has heightened the interest in emerging markets. There are many studies in forecasting stock exchange movements and many of them show that neuro-computational models are useful tools in forecasting the movements of emerging stock markets. Due to their ability to extract useful information from a large set of data, robustness and flexibility of modeling algorithms, neuro-computational models are expected to outperform traditional statistical techniques such as regression and ARIMA in forecasting of stock exchanges' price and index movements (Mostafa 2010).

In this paper, BELEX 15, the main index of Belgrade Stock Exchange, has been investigated and modeled by artificial neural network, with several local and global inputs. The results obtained by simulation were compared to the results of random walk method and similar studies.

The remainder of this paper is organized as follows: The background of this study and a brief literature review are summarized in the next section. In addition, foundations of feedforward neural networks are presented. In Section 3, the methodology and proposed neural network model of BELEX 15, with the explanation of all relevant elements, are given. The simulation results of forecasting are given and discussed in Section 4. Finally, in Section 5, concluding remarks and future research directions are provided.

### Background

Artificial neural network (ANN) can be defined as mathematical model based on the human brain. The brain consists of a densely interconnected set of nerve cells, called neurons and connections between them, called synapses (Negnevitsky 2011). Each neuron has a very simple structure, but approx. 10 billion neurons in human brain make a tremendous processing power. Each neuron consists of a cell body (soma), a number of fibers called dendrites (branched around the soma), and a single long fiber called axon (which stretches out to the dendrites and somas of other neurons).

Similarly, an ANN consists of a number of simple and highly interconnected processing units, also called neurons, by analogy with brain neurons. Neurons are organized in layers, as can be seen in typical ANN architecture, in Figure 1.

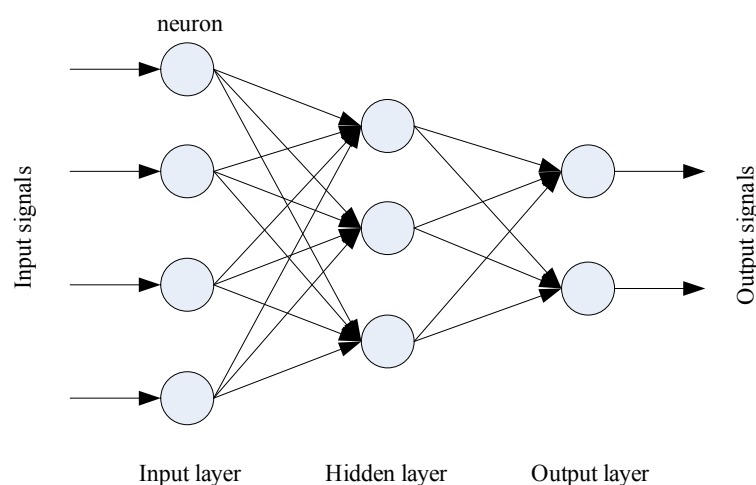

**Figure 1. Typical ANN architecture**

The neural network (NN) has one input layer, one or more hidden layers, and one output layer. The neurons in the input layer receive and process input signals. All neurons are connected by weighted links (weights correspond to the biological synapses), passing signals from one neuron to another. Neuron may have several input signals, but produces a single output signal, which is transmitted through the neuron's outgoing connection (corresponding to the biological axon), split and fed to the inputs of other neurons in the network (inputs correspond to the biological dendrites) (Negnevitsky 2011).

Each neuron can be seen as a simple computing element, and its basic structure is shown in Figure 2.

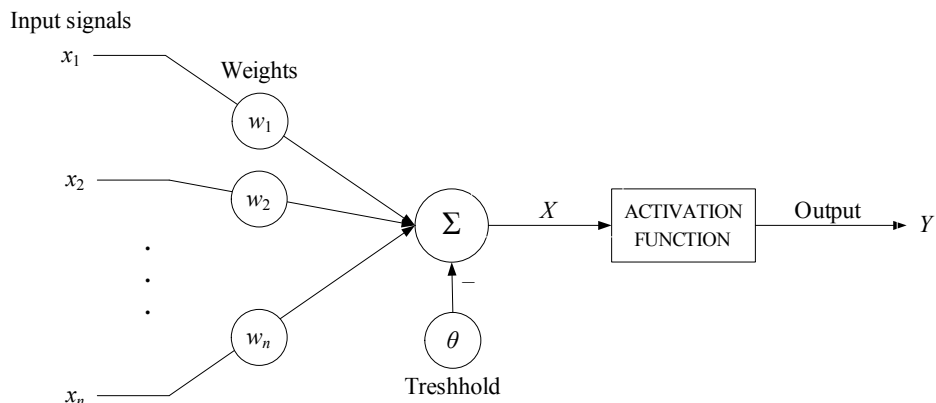

Figure 2. Structure of a neuron

The neuron computes the weighted sum of its inputs, and subtracts a threshold value,  $\theta$  (Negnevitsky 2011; Panahian 2011):

$$X = \sum_{i=1}^n x_i w_i - \theta \tag{1}$$

The difference  $X$  is fed to the activation function, which produces the output of the neuron. The most often used activation function in neural networks for forecasting problems is sigmoid (logistic, logsig) function:

$$Y = \frac{1}{1 + e^{-X}} \tag{2}$$

but also step, sign, linear and tansig functions are used, in different applications (Dutta et al. 2006, Negnevitsky 2011).

In the most popular type of neural networks, the input signals are fed forward through the neural network and this type of network is called feedforward NN. It is the most often used type for finance and economics forecasting problems (Atsalakis and Valavanis 2009; Lawrence, 1997; Kaastra and Boyd 1996). The training of the network is performed in two steps: in first, the input signals are fed

## **STOCK MARKET INDEX FORECASTING USING NEURAL NETWORK MODELS: STUDY OF BELGRADE STOCK EXCHANGE**

---

through the network and the computed outputs are obtained. In second step, the error in training process, i.e. the difference between desired and computed outputs, is fed back through the network (in the opposite direction) and the weights are adjusted so to minimize the sum of squared error (initial weights and thresholds are set randomly). The steps are repeated until solution converges to pre-specified mean square error value. This type of network is called back-propagation NN, because the network is trained by propagation of the output error backwards, and it is the most often used method of training. More on details on neural network training and different training algorithms can be found in Negnevitsky (2011).

As stated in the Introduction, neural networks are often used in forecasting in stock markets, especially for stock market index prediction. A stock market index is usually composed of a weighted average measure of the prices of selected stocks which make up that index, and very often is used as a general barometer of the market. Therefore, the ability to even partially forecast the future value of an index would be of considerable interest to the investors.

The Efficient Market Hypothesis (EMH) states that at any time, the share price fully captures all known information about the share. Since all known information is used by all market participants, price variations are random, as new information occurs randomly. Thus, share prices perform a "random walk", and it is not possible for an investor to beat the market i.e. to predict the future share price (Lawrence, 1997). The EMH is important in stock trading, because it contradicts all other forms of analysis i.e. if it is impossible to predict the market movement, then technical, fundamental, or time series analysis should lead to no better performance than random guessing. The fact that many market participants can consistently beat the market is an indication that the EMH may not be true in practice (it could may be true in the ideal world with equal information distribution, but today's markets contain privileged players, who can beat the market by using inside information or other means). Although many economists support the Efficient Market Hypothesis (EMH), which states that there is no room for stock forecasting, many researchers reported studies to reject this hypothesis.

Leung et al. (2000) have made a comparison of different classification and estimation models, including classical (linear discriminant analysis, binary choice models, adaptive exponential smoothing, vector autoregression with Kalman filter, multivariate transfer function - ARIMA model) and neural network (probabilistic and feedforward) models in monthly prediction of three important stock indices: US S&P500, UK FTSE 100 and Japan Nikkei 225. They reported that neural networks in most cases outperformed classical methods, and that the best accuracy of the sign-of-return prediction was in range 56%-68%.

In their study, Fernandez-Rodríguez et al. (2000) investigated the forecasting of the General Index of the Madrid Stock Market, by using three-layer feedforward neural network. The inputs to the network were returns of previous nine days, and hidden and output layers had four and one nodes, respectively. The authors reported 54%-58% successful sign predictions, depending on the market stage (bear, stable or bull market), which are better than random walk direction forecast.

Dutta et al. (2006) successfully tested and compared two large neural networks, with 800 neurons in input layer, three hidden layers with 600 neurons each, and a output layer with a single neuron, to forecast Stock Price Index of Bombay Stock Exchange (BSE SENSEX). As inputs, they suggested weekly closing prices of SENSEX for the past 200 weeks, 5-week and 52-week moving averages of the weekly closing values for the past 200 weeks, 5-week volatility of the weekly closing prices, etc.

In their paper, Tillakaratne et al. (2007) examined two forecasting techniques: feedforward and probabilistic neural networks, in one-day-ahead prediction of trading signals of Australian All Ordinary Index (AORD). These forecasts were based on the current day's relative return of the closing price of the US S&P 500 Index, the UK FTSE 100 Index, French CAC 40 Index and German DAX

Index as well as the AORD. They concluded that feedforward NN performed better than probabilistic NN in prediction evaluation of classification/ misclassification rate as well as trading simulations.

In their study, Chaigusin et al. (2008) also used feedforward back-propagation neural networks, in order to forecast the Stock Exchange of Thailand (SET) index. They used seven inputs to the networks: the SET index, the Dow Jones index, the Nikkei index, the Hang Seng index, the gold price, the Minimum Loan Rate (MLR) and the exchange rates of the Thai Baht and the US dollar. Authors have experimented with three, four and five layer networks (one, two and three hidden layers), and different number of neurons in hidden layers (output network always had only one node), and reported that the best results were obtained using 7-3-1, 7-7-3-1 and 7-13-7-3-1 network architectures.

Erdinc and Satman (2005) used ANN and Regression Models for the prediction of Istanbul Stock Exchange Market index on daily, weekly and monthly basis. They reported the prediction success of ANN on daily, weekly and monthly datum as 57.8%, 67.1%, and 78.3%, respectively. Also, Diler (2003) used the back-propagation ANN model to predict the direction of Istanbul Stock Exchange Market 100 index, and accurately estimated the direction the following day as 60.81 % (as cited in Yildiz et al. 2008).

ANN model to predict the direction of the Istanbul Exchange National 100 index (ISI National-100) was also used by Yildiz et al. (2008). As input variables they used the highest and lowest intraday index values, the closing price, the U.S dollar exchange rate, etc. The output variable was the direction of the index on the following day, i.e. if the index increased, the rate was considered as 1, while when the index decreased, the rate was considered as 0. They also used multi-layer feed-forward neural network model, with one hidden layer and back-propagation training algorithm. Authors reported the accuracy of 74.51% in prediction of the following day direction of the index.

De Faria et al. (2009) applied the two forecasting models (Artificial neural networks and Adaptive exponential smoothing (AES) model) to predict Ibovespa, the principal index of the Brazilian stock market and to compare the number of correct predictions of the sign of the index returns of both methods. They used a multi-layer feed-forward neural network model, with back-propagation (BP) training algorithm. The network architecture included one input layer with the number of neurons equal to the number of days in the input window (different sizes of input window were tested, from 3 to 60 days), one hidden layer with several neurons (5 to 25), while the output layer had one neuron corresponding to the prediction result. The best results were obtained using 60-15-1 and 15-15-1 network structures, with 60% and 59% of correct tendencies number hit. The correct predictions using AES model were lower, with larger root-mean square error.

Fang and Ma (2009) used BP neural network model to predict the closing price of Shanghai Stock Exchange Index. They used three layer network architecture, with 12 inputs (open, close, high, low prices, amount, 5- and 10-day moving averages and some technical indicators, such as RSI, BIAS, K, D and J indexes), 6 nodes in hidden layer and one output (next day closing price). Authors concluded that neural network models can be effectively used for short-time stock market trend prediction.

The application of neural networks for the forecasting of stock exchange movements was also performed on the following Stock Exchanges: Johannesburg (Lawrence 1997), Kuwait (Mostafa 2010), Taiwan (Chen et al. 2003), Iran (Panahian 2011), Toronto (Olson and Mossman 2003), NASDAQ (Chen et al. 2005), etc. (more examples could be found in the survey paper by Atsalakis and Valavanis 2009).

## **Methodology**

The objective of the research presented in this paper is to illustrate that ANNs can effectively be used to predict one-day-ahead value of BELEX 15, the main index of Belgrade Stock Exchange (BELEX). It is often used as a measure of the movement of the most liquid Serbian shares, and therefore, the movement of Serbian stock market. BELEX 15 index was established on October 01, 2005, and it comprises of up to 15 most liquid shares traded using the continuous trading method on Belgrade Stock Exchange, the main Serbian stock market. The influence of the index components is limited to a maximum of 20% of the total market capitalization of the index on the revision date (Belex 2012). The index is calculated every working day, in real-time, based on current stock prices and its composition is revised twice a year.

The design of neural network forecasting model was done using eight-step model, suggested by Kaastra and Boyd (1996).

First step considers variable selection, because knowing which inputs are important in the market being forecasted is critical. As an output, only one-day-ahead value of BELEX 15 index is adopted, which is the case broadly supported in the literature (Atsalakis and Valavanis 2009, Zhang et al. 1998). As input variables, three previous day values of the index are adopted as first three inputs. Also, as a local financial indicator, the previous day value of RSD/EUR exchange rate was adopted as fourth input. Since financial world is nowadays global and emerging markets are greatly influenced by well established markets (Atsalakis and Valavanis 2009), as input variables for the network, beside local financial indicators, some global financial indicators, such as EUR/USD exchange rate and the indices of the main world stock markets, were also used. As the foreign stock markets that are most influential on Belgrade Stock Exchange, main US and European Stock Markets were considered. Preliminary research, using sensitivity analysis, tested five main indices, but NASDAQ and DJIA were dropped, since they didn't have positive influence to the BELEX 15 prediction, leaving remaining three indices as network inputs: US S&P 500, UK FTSE 100 and German DAX.

In many cases input data has a large range of values, reducing the effectiveness of training procedures (Atsalakis and Valavanis 2009). This may be overcome by data pre-processing i.e. data normalization, usually by scaling data into the range [0, 1] or [-1, +1], which provides shorter training times and better performance (Kaastra and Boyd 1996). In this paper, all inputs are normalized to the range [-1, +1], using linear normalization:

$$\bar{x} = 2 \cdot \frac{x - x_{\min}}{x_{\max} - x_{\min}} - 1 \quad (3)$$

where  $\bar{x}$  is normalized,  $x$  is original,  $x_{\min}$  is minimal and  $x_{\max}$  is maximal value of the input set.

The data set used in this study is divided into two sets. The first data set, used for network training, validation and testing, is randomly (by simulation software) divided into three data subsets. The first subset, containing 60% of the data set, is the training set, which is used for computing the gradient and updating the network weights and thresholds. The second subset containing 20% of the data set, is the validation set, which is used for training validation, i.e. the error on the validation set is monitored during the training and it normally decreases during the initial phase of training, as does the training set error. Training on the training set continues as long the training reduces the network's error on the validation set. However, when the network begins to overfit the data, the error on the validation set typically begins to rise, so the training is stopped, and the weights and thresholds at the minimum



of the validation error are returned. Finally, the last 20% of the data set constitute the test set, which provides an independent test of network generalization to data unknown to the network. The second data set is used only for simulation i.e. independent testing of the network.

One of the main issues in neural network modeling is the selection of the number of hidden layers/nodes, and very often only trial-and-error gives acceptable solution. With one hidden layer any continuous function can be represented, and with two hidden layers even discontinuous functions can be represented (Negnevitsky 2011). So, typically, a back-propagation network has fully connected three or four layers (every neuron in each layer is connected to every neuron in the next forward layer), i.e. the most often number of hidden layers is one or two (Atsalakis and Valavanis 2009). Chaigusin et al. (2008) compared networks with one, two and three hidden layers and, under same conditions (inputs, data sets, etc.) they reported no significant improvement in prediction performance, measured by mean absolute percentage error (MAPE). Egeli et al. (2003) also compared feedforward neural networks with one, two and four hidden layers and reported even the degradation in accuracy with more hidden layers.

Number of neurons in the hidden layer affects both prediction accuracy and speed of network training. Simulation experiments indicate that to some point higher number of neurons in the hidden layer gives higher prediction accuracy (Negnevitsky 2011); however, too many of them can dramatically increase the computational load. Another problem is overfitting. If the number of hidden neurons is too big, the network might simply memorize all training examples and not be able generalize i.e. to give correct output with data not used in training. There is no general rule how to determine the number of hidden neurons, so usually the rules-of-thumb and trial-and-error are used. Yao et al. (1999, as cited in Chaigusin et al. 2008) and Panahian (2011) suggest the following equations for the calculation of the number of hidden neurons  $m$ :

$$m = \sqrt{n \cdot l} \quad (4)$$

$$m = \ln(n) \quad (5)$$

where  $n$  – is the number of input neurons and  $l$  – is the number of output neurons. Fang and Ma (2009) give similar suggestion:

$$m = \log_2(n) \quad (6)$$

Taking in mind all presented above, one hidden layer with three hidden neurons, i.e. **8-3-1** architecture were adopted in analyzed model.

Concerning the choice of activation function, feedforward networks with one sigmoid layer and one linear layer are known to be able to model non-linear relationships of great complexity (Bishop 1995), so sigmoid function (given by Eq. (2)) was adopted for the neurons in the hidden layer, and pure linear function was adopted for the output layer.

During network training, the weights and thresholds of neurons are iteratively adjusted to minimize the network performance function. There are several solutions, but most often used performance function for feedforward networks is mean square error (MSE) i.e. the average squared error between the network outputs (predictions) and the target (desired) outputs. Although there are several different training algorithms, in this study Levenberg-Marquardt algorithm was used, because it appears to be the fastest method for the training of moderate-sized feedforward neural networks.

### **Simulation results**

This study covers the time period from February 01, 2008 to February 29, 2012. Thus, the data set contained 1030 trading days i.e. data points in time series, and it was divided into two periods. The first period, from February 01, 2008 to December 30, 2011, is in-sample estimation period, used for model training, testing and validation. This data set is randomly divided into training, validation and testing subsets, at 60%-20%-20% ratio. The second period, from January 04, 2012 to February 29, 2012, is reserved out-of-sample evaluation period, used to independently evaluate forecasts of the model. The input data were collected using on-line resources, i.e. official web site of Belgrade Stock Exchange (<http://www.belex.rs>) for BELEX 15 index values, official web site on National Bank of Serbia (<http://www.nbs.rs>) for RSD/EUR exchange rate, OANDA web site (<http://www.oanda.com>) for EUR/USD exchange rate and Yahoo Finance web site (<http://finance.yahoo.com/>) for main stock market indices used as inputs (S&P 500, FTSE 100 and DAX). The missing values in time series were filled with previous day observations.

The training was performed using Levenberg-Marquardt algorithm, and it was done in 49 epochs (each epoch represents an entire pass through all training data). The mean squared error during network training/validation/testing is shown on Figure 3.

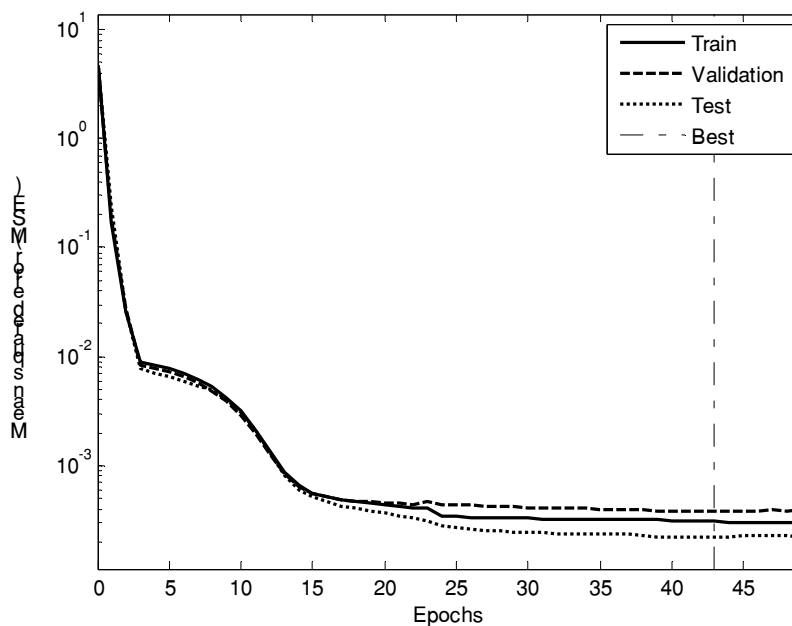

**Figure 3. Mean squared error during network training/validation/testing**

It can be seen that training, validation and testing error are decreasing during experiment. Also, the best validation performance was found at epoch 43, so these network parameters (weights and thresholds) were taken as final.

After training, validation and testing on first data set, an independent test, using second data set, unknown to the network, was performed, and actual vs. predicted (using neural network model) values of BELEX 15 index are shown on Figure 4.

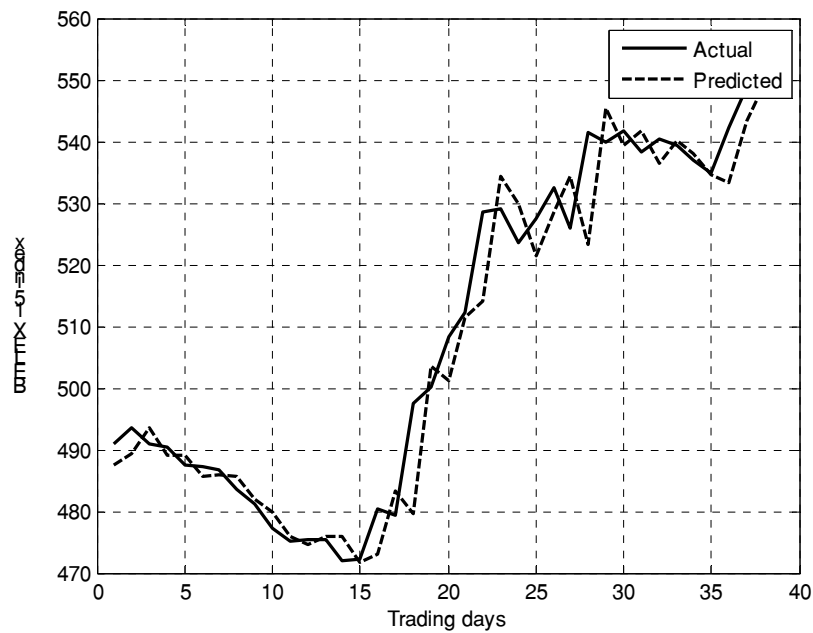

**Figure 4. Actual vs. predicted values of BELEX 15 index**

It can be seen a very good prediction capability of the model i.e. predicted values follow actual ones with a small error. The most common statistical measures of neural network model accuracy and performance are (Zhang et al. 1998; Avci 2009):

- sum of squared error (SSE),
- mean squared error (MSE),
- root mean squared error (RMSE),
- mean absolute percentage error (MAPE) and
- mean absolute error (MAE), also known as mean absolute deviation (MAD).

and their values for the simulation model presented in this paper and the second input data set are given in Table 1.

**Table 1. The main performance measures of simulation model**

Performance measure	Abv.	Value
sum of squared error	SSE	1446.5
mean squared error	MSE	38.0670
root mean squared error	RMSE	6.1698
mean absolute percentage error	MAPE	0.8408
mean absolute error	MAE	4.3354

## STOCK MARKET INDEX FORECASTING USING NEURAL NETWORK MODELS: STUDY OF BELGRADE STOCK EXCHANGE

---

One of the most common used performance measures is so called Hit Rate, which measures the percentage of correct predictions of the model (Atsalakis and Valavanis 2009). This measure is usually compared with the measure obtained by the random walk model, which assumes that the best forecast is equal to the most recently observable observation i.e. to last known value (Chen et al. 2003).

In the presented experiment, the value of Hit Rate was 63.16%, which is higher or comparable with the findings of similar studies, given in the Introduction. Also, it is much higher than the value obtained using random walk model, which for the second data set was 52.63%.

### Conclusion and further research

Stock market trend forecast is an important issue in financial sector and many studies on this topic can be found in the literature, applying different methods, including statistical and artificial intelligence. In this paper, a feedforward back-propagation multilayer neural network model for one-day-ahead prediction of BELEX 15, Belgrade Stock Exchange index is presented. Past values of the index, EUR/RSD and EUR/USD exchange rates and the indices of well established markets (S&P 500, FTSE 100 and DAX) were used as inputs, and the output was forecast of next-day BELEX 15 value. It was shown that neural network model give better results than random walk model and, therefore, could be used as a useful tool in making trading decisions on stock markets. Of course, in order to continuously use NN models, the network should be periodically re-trained with the fresh data.

Further research include the sensitivity analysis on new input parameters, including macro-economic indicators, indices of regional stock markets, local and global interest rates, etc., in order to develop new, more accurate NN models. Also, the application of hybrid AI models (neuro-fuzzy or combination with genetic algorithms, for optimal network configuration) may give better performance and forecast results.

### Acknowledgements

The research presented in this paper was supported by the Ministry of Education and Science of the Republic of Serbia, Grant III-44010, Title: *Intelligent Systems for Software Product Development and Business Support based on Models*

### References

- Atsalakis, G., Valavanis, K. (2009). Surveying stock market forecasting techniques – Part II: Soft computing methods. *Expert Systems with Applications*, 36 (2009), pp. 5932-5941
- Avci, E. (2009). Stock market forecasting with artificial neural network models: an analysis of literature and an application on ISE 30 index, *Istanbul University, Faculty of Economics Journal*, Volume 59, Issue 1, p: 55, (10 July 2012) <<http://www.iudergi.com/tr/index.php/iktisatmecmua/article/viewFile/6576/6100>>
- Belex (2012). *BELEX15 Methodology*. Belgrade Stock Exchange, (13 July 2012) <[http://www.belex.rs/files/e\\_trgovanje/BELEX15\\_metodologija.pdf](http://www.belex.rs/files/e_trgovanje/BELEX15_metodologija.pdf)>
- Bishop, C.M. (1995). *Neural network for Pattern Recognition*. New York: Oxford University Press

- Chaigusin, S., Chirathamjaree, C., Clayden, J. (2008). The Use of Neural Networks in the Prediction of the Stock Exchange of Thailand (SET) index. *2008 IEEE International Conferences on Computational Intelligence for Modelling, Control and Automation; Intelligent Agents, Web Technologies and Internet Commerce; and Innovation in Software Engineering*, December 2008, Vienna, Austria
- Chen, A.-S., Leung, M.T., Daouk, H. (2003). Application of neural networks to an emerging financial market: forecasting and trading the Taiwan Stock index. *Computers and Operations Research*, 30 (2003), pp. 901-923
- Chen, Y., Dong, X., Zhao, Y. (2005). Stock index modelling using EDA based local linear wavelet neural network. *Proceedings of International Conference on Neural Networks and Brain*, pp. 1646–1650
- de Faria, E.L., Albuquerque, M.P., Gonzalez, J.L., Cavalcante, J.T.P., Albuquerque, M.P. (2009). Predicting the Brazilian stock market through neural networks and adaptive exponential smoothing methods. *Expert Systems with Applications*, 36 (2009), pp. 12506-12509
- Dutta, G., Jha, P., Laha, A.K., Mohan, N. (2006). Artificial Neural Network Models for Forecasting Stock Price Index in the Bombay Stock Exchange. *Journal of Emerging Market Finance*, 5:3 (2006), pp. 283-295
- Egeli, B., Ozturan, M., Badur, B., (2003), Stock Market Prediction Using Artificial Neural Networks, *Proceedings of the 3rd Hawaii International Conference on Business*, Hawaii, USA.
- Erdinc, A., Satman, M.H. (2005). Stock Market Forecasting: Artificial Neural Network and Linear Regression Comparison in An Emerging Market. *Journal of Financial Management and Analysis*, Vol. 18, 2005.
- Fang, B., Ma, S. (2009). Application of BP Neural Network in Stock Market Prediction, *Proceedings of the 6th International Symposium on Neural Networks: Advances in Neural Networks, ISNN 2009 - Part III*, pp. 1082 – 1088
- Fernandez-Rodríguez, F., Gonzalez-Martel, C., Sosvilla-Rivero, S. (2000). On profitability of technical trading rules based on artificial neural networks: Evidence from Madrid stock market, *Economics Letters*, 69 (2000), pp. 89-94
- Kaasra, I., Boyd, M. (1996). Designing a neural network for forecasting financial and economic time series. *Neurocomputing*, 10 (1996), pp. 215-236
- Lawrence, R. (1997). *Using Neural Network to Forecast Stock Market Prices*. University of Manitoba, working paper
- Leung, M.T., Daouk, H., Chen, A-S. (2000). Forecasting stock indices: a comparison of classification and level estimation models. *International Journal of Forecasting*, 16 (2000), pp. 173-190
- Mostafa, M.M. (2010). Forecasting stock exchange movements using neural networks: Empirical evidence from Kuwait. *Expert Systems with Applications*, 37 (2010), pp. 6302-6309
- Olson, D., Mossman, C. (2003). Neural network forecasts of Canadian stock returns using accounting ratios. *International Journal of Forecasting*, 19(3), pp. 453–466
- Panahian, H. (2011). Stock Market Index Forecasting by Neural Networks Models and Nonlinear Multiple Regression Modeling: Study of Iran’s Capital Market, *American Journal of Scientific Research*, Issue 18 (2011), pp. 35-51
- Tillakaratne, C.D., Morris, S.A., Mammadov, M.A., Hurst, C.P. (2007). Predicting Stock Index Trading Signals Using Neural Networks, *Proceedings of the 14th Annual Global Finance Conference (GFC 2007)*, Melbourne, Australia
- Yildiz, B., Yalama, A., Coskun, M. (2008). Forecasting the Istanbul Stock Exchange National 100 Index Using an Artificial Neural Network. *International Journal of Social and Human Sciences*, 2 (2008), pp. 573-576
- Zhang, G., Patuwo, B.E., Hu, M.Y. (1998). Forecasting with artificial neural networks: The state of the art, *International Journal of Forecasting*, 14 (1998), pp. 35-62



# CDS SPREADS, PROBABILITIES OF DEFAULT AND RISK PREMIUMS IN THE LATEST DEBT CRISIS

Irena Janković<sup>1</sup>

**Abstract:** *Credit default swaps (CDSs) offer insurance to protection buyer against the event of the default on certain claim. CDS spread represent a premium paid by the side of protection buyer to protection seller for the risk transfer. Together with data on yield spreads, i.e. risk premiums the CDS spreads offer market participants a signal about the riskiness of their investment. These spreads can be used for calculation of implied probabilities of default of a debtor. The aim of this paper is to present, calculate and comment sovereign default probabilities for vulnerable member states of the Eurozone. Together with the risk premium behavior analysis the result is a more complete picture of the ongoing debt crisis in the euro area.*

**Keywords:** *CDS spreads, default probabilities, risk premiums, Eurozone debt crisis*

## Introduction

The 2008 crisis had particularly strong consequences for the Eurozone member states. Beyond prolonged recession and stop in foreign capital flows, the crisis caused economic and financial adjustments that led to sovereign debt crisis especially in those countries that in the previous expansionary period have successfully hidden underlying structural and fiscal imbalances. The situation is still bad especially in the south-western countries and new members of the EU because of their accumulated macroeconomic and financial weaknesses. The unrealistic expectation that EU and euro area institutions will provide enough protection against instability resulted in discipline erosion at both, the level of the EU and national levels. The relative fulfillment of convergence criteria in the previous decade has hidden more profound fundamental imbalances that did not cause timely market reactions. Before the crisis credit risk premiums in this region (in practice measured by CDS spreads) seemed to have neglected fiscal imbalances and have reflected mostly external and financial imbalances. The severity of the ongoing debt crisis has brought underlying institutional and structural fragilities to the light demanding better economic governance and supervision.

The crisis hit strong Greece, Portugal, Ireland, Spain and Italy, but also some new EU member states (with mostly fixed exchange rate regimes). These countries demanded external financial support to avoid default. Although the imbalances were for longer time unsustainable, markets and regulators did not promptly react. The risk was undermined in peaceful times, since institutional setup as it was has masked true financial and broader economic picture for member states of the EMU and some accessing countries. Disciplinary effect of the market was thus felt suddenly when the crisis started.

## Bad convergence process

In the period before the crisis we were the witnesses of the strong real convergence process among the core and periphery member states of the EU<sup>2</sup>. From the introduction of the euro in 1999,

---

<sup>1</sup> Faculty of Economics, University of Belgrade, irenaj@ekof.bg.ac.rs

<sup>2</sup> Core countries of the euro area: Austria, Belgium, France, Germany, Netherlands, Finland; euro area periphery: Greece, Ireland, Italy, Portugal, Spain; new EU member states with fixed exchange rates:

## CDS SPREADS, PROBABILITIES OF DEFAULT AND RISK PREMIUMS IN THE LATEST DEBT CRISIS

---

the average real GDP growth rate in the periphery countries was significantly higher compared to the core, leading them closer to EU average growth rate.

**Table 1. Real EU states convergence in the period 1998-2007**

---

	Euro area core	Euro area periphery	New member states (fixed exchange rate)	New member states (floating exchange rate)
Average real GDP growth rate	2%	3.6%	6.7%	4.2%

---

Source: Eurostat

The catch up process where lower income countries grow faster after institutional and structural reforms was facilitated in the EU framework due to the accession process, unique currency introduction, single market and significant transfers from EU structural funds. The capital inflows initially based on FDI flows and later mostly on bank loans from parent EU banks in the phase of high global liquidity and the expansion caused risk premiums reduction. The member states sharing the unique monetary policy were basing interest rates on the ECB rate, while most new member states were pegged to euro through ERM II (Alberola, E. et al. 2012, p. 11). Long term nominal interest rates converged to German levels resulting in negative real interest rates before the crisis which led to expansion and overheating.<sup>3</sup> The inflationary pressures were not present in the core countries and could be better managed by new member states of the EU that had flexible exchange rates and more flexible monetary policy as a possible stabilizer. Thus real interest rate divergence process was obvious between different member groups of the EU even before the crisis, but was mostly neglected by EU authorities and markets. Relaxed financial circumstances together with optimistic expectation of growth led to bad convergence and large macroeconomic and financial imbalances which were not timely addressed. Massive risk taking that followed credit and housing expansion and price bubble increased internal and external debt of the mostly private non-tradable sectors and consumption instead of investments. The real exchange rate appreciation led to large current account deficits. Budget revenues increase from housing and financial sector prosperity and demand driven growth was not regarded as cyclical but rather structural that resulted in insufficient fiscal discipline in good times. Finally, the crisis and ongoing recession brought to the light accumulated fiscal problems in some member states.

Empirical analyses confirm significant correlation between asset (house) prices and current account balances, credit growth and foreign currency credit, especially in non euro EU countries (Alberola, E. et al. 2012, p. 15).

The fastest “converging” countries were hardest hit. The adjustments were significant as much as previous development was unsustainable.

---

Bulgaria, Estonia, Latvia, Lithuania; new EU member states with floating exchange rates: Czech Republic, Hungary, Poland, Romania.

<sup>3</sup> See more on “convergence play” in e.g. Goldstein et al. (1993)



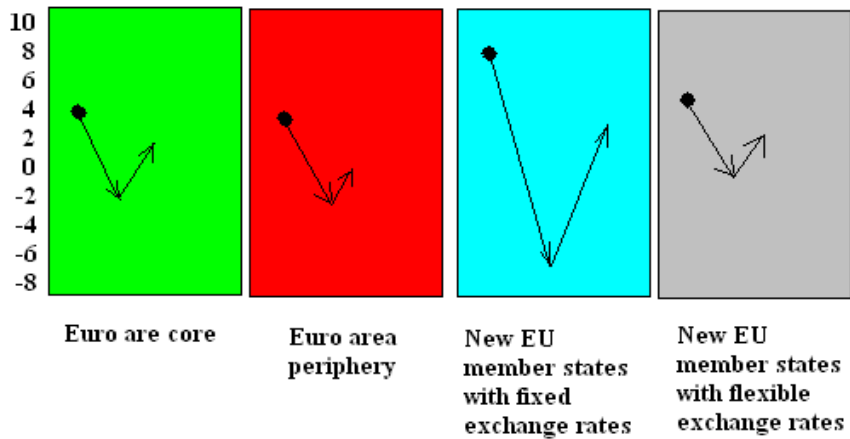

Graph 1. Real GDP growth from 2007-2012 (in %)

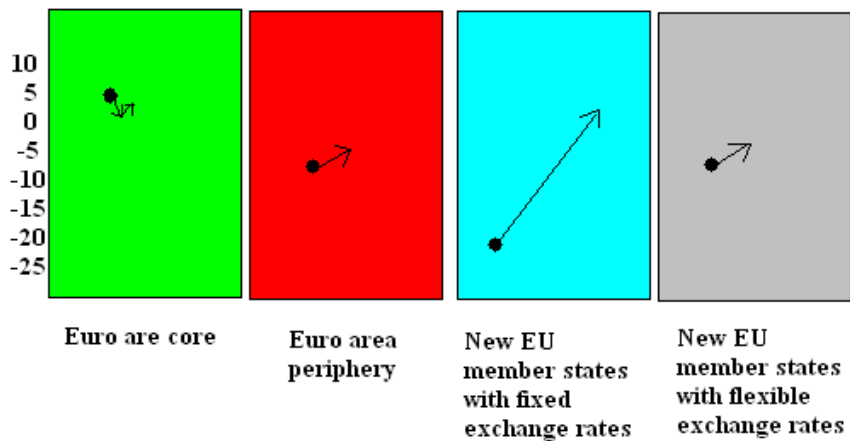

Graph 2. Current account balance in period 2007-2012

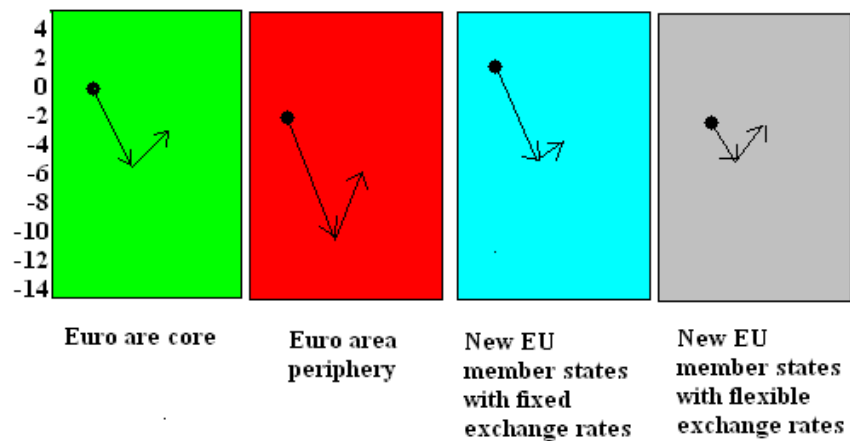

Source: Eurostat and IMF forecasts

Graph 3. Net lending/Net borrowing of general government in 2007, 2009 and 2011

**CDS SPREADS, PROBABILITIES OF DEFAULT AND RISK PREMIUMS IN THE LATEST DEBT CRISIS**

The significant decrease in GDP growth is specific for new member states with fixed exchange rates and euro area periphery. At the same time, some countries from the former group even went from current account deficit to surplus, not due to recovery and export increase, but rather fall in domestic demand and reduced external financing. Fiscal positions deteriorated due to significant adjustments, fall in public revenues and shift of the private debt to public debt. External help from IMF and EU became a necessity. It required significant consolidation and reforms. Euro area periphery was hardest hit but also new member states of the EU.

The institutional framework of EU and euro area was originally aimed at higher level of integration, economic convergence and monetary unification of member states after the adoption of the euro. Participation in the ERM II and compliance with convergence criteria for the entrance in the Eurozone should have been followed by higher fiscal discipline and supervision as proclaimed by the Stability and Growth Pact. The crisis showed that this framework was not adequate enough. It covered up the underlying imbalances, structural in nature, even when the main criteria were fulfilled. But even when some core countries (Germany, France) of the zone broke some main criteria such as 3% of the GDP deficit rule, there was no sanctions. That decreased the credibility of the Pact and discipline of the member states. New member states of the EU, on the other side, tried to enter the euro area as soon as possible without enough preparation and participation in the ERM II. By changing their currency regime they avoided the consolidation of fundamentals and further accumulated imbalances. They saw the Eurozone as a safe territory and escape from their financial vulnerabilities and political and economic difficulties. This moral hazard behavior has raised macroeconomic and financial risks. The absence of predefined criteria for participation in ERM II, inadequate supervision and the superficial rules for the participation in EMU have limited the control over too early entries in the Eurozone. These and other institutional gaps let to a situation in which early warning signals were not timely identified nor effective actions, of both EU and national authorities, taken to prevent the crisis.

**CDS spreads as credit risk indicators**

Credit default swaps (CDSs) are credit derivative instruments that offer insurance against default risk of a certain counterparty. Protection buyer purchases the protection against the event of default on some loan or security it holds as a part of its assets. In order to get insurance it pays a premium to protection seller. If the default happens, the protection seller has to compensate the protection buyer for the loss.

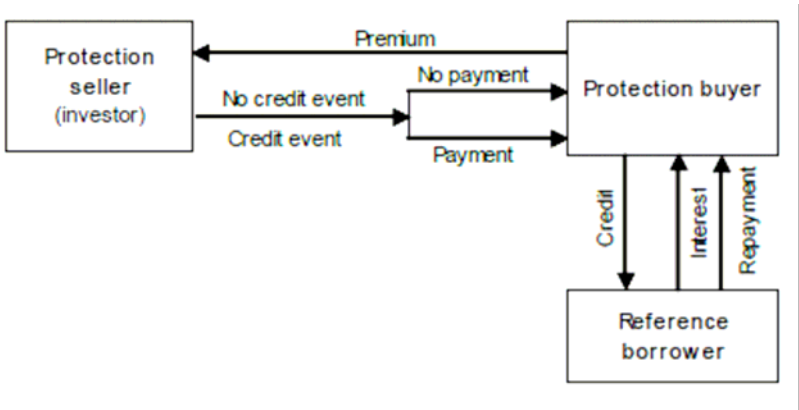

**Graph 4. Credit default swap structure**

CDS spreads represent premiums that are paid by the side of protection buyers to protection sellers. The payment is usually done quarterly. The CDS spreads are quoted in basis points per annum based on the notional amount of the contract. For example, if CDS spread is on the level of 459 basis points for Italian five year debt<sup>4</sup> that means that default insurance premium for a notional amount of 1 million Euros costs €45,900 annually, i.e. €11,475 quarterly. If on the same day, CDS spread on German debt of the same maturity is 88 basis points, and the resulting premium €8,800 per annum we can see the underlying credit risk differential determined by the market for these two instruments. The use of CDS premium as a measure of credit risk is very common in empirical analysis, although it is argued that it may also reflect some other factors such as liquidity risk or counterparty risk. Despite that it is a convenient variable that is daily and intra-daily available in the market. The price is faster discovered than for e.g. government bonds. Thus the role of CDS spreads is valuable in monitoring the crisis evolution and market reactions to rising credit risk. We will refer to the check of this in the empirical evidence part of the paper.

***Valuation of CDS contracts and implied probability calculation***

For the protection buyer the value of a CDS contract is equal to the difference between the expected present value of the contingent payments in the case of default and expected present value of the fixed payments (i.e. premium flows).

**CDS value for protection buyer:**

**Expected present value of contingent payments - Expected present value of fixed payments**

In order to value the CDS contract we introduce the following notation:  $S$  for CDS spread (premium) which is paid in fractions  $d_i$ ,  $p$  for probability of default,  $R$  for recovery rate,  $N$  for maturity of the contract,  $D(t_i)$  for the discount factor from the US zero curve.

We denote the survival probability of the underlying claim:

$$q = 1 - p \tag{1}$$

with a discrete time profile:

$$q(t_i), i = 1 \dots N \tag{2}$$

If we assume that there is no counterparty risk then:

$$PV_{fixed\ payments} = \sum_{i=1}^N D(t_i) q(t_i) S d_i + \sum_{i=1}^N D(t_i) \left\{ q(t_{i-1}) - q(t_i) S \frac{d_i}{2} \right\} \tag{3}$$

Where the first part of the expression (3) refers to the discounted premium payments if there is no default, and the second sum refers to the accrued premium flows if default happens between the payment days.

---

<sup>4</sup> Data are collected from Bloomberg for May 11<sup>th</sup> 2012.

$$PV_{contingent\ payments} = (1 - R) \sum_{i=1}^N D(t_i) \{q(t_{i-1}) - q(t_i)\} \quad (4)$$

The two parties enter the CDS contract if the value of the swap transaction is set to zero, i.e. (3)=(4).

In a simple case if we assume a 1-year CDS contract with a total premium paid upfront the protection buyer has the expected payment equal to  $S$  with expected payoff equal to  $(1-R)p$ .

When parties enter a contract premium  $S$  is set so that the value of the transaction is equal to zero.

$$S = (1 - R)p \quad (5)$$

The value of the contract changes over time as does a market value of the premium  $S$ .

Expression (5) we can translate into an implied probability of default:

$$p = \frac{S}{(1 - R)} \quad (6)$$

For daily spread data we can thus calculate implied probability of default based on defined recovery rate. For example, if recovery rate is 40%<sup>5</sup>, then a CDS spread of 300bp would translate into the probability of default of 5%.

The majority of pricing models does not take into account the negative correlation between the recovery rates and default probabilities although it is empirically well documented.

In the previous period of significant market disturbances a number of papers dealt with the issue of recovery risk in credit risk models. The attempt was usually to extract implied recovery rates or probabilities of default from prices of bonds or CDS spreads. Most of the studies are based on strong assumption that recovery rates are constant and independent from probabilities of default. However, what empirical evidence shows is rather a stochastic nature of recovery rates and negative correlation with default rates (see e.g. Altman et al. 2005, Altman, 2009 and Jaskowski, 2011).

### **Bond yields' behavior**

Concept of CDS spreads as insurance premium in percent of notional amount of the contract differs from the concept of yield spreads (yield differential of a bond over a "risk-free" bond, usually US Treasury or German Bund yield). In comparison to CDS premium concept that mainly reflects the credit risk, government bond yields are regarded as representatives of the behavior of the wider set of fundamentals of the respective economy. It is a measure that encompasses several risks, such as credit risk, liquidity risk, counterparty risk, and broadly speaking the sovereign risk of a country. It also reflects the risk aversion, or the willingness of market participants to take risk. In comparison to CDS spreads that are more frequently and timely available in the market, bond yield are expected to show the behavior of greater number of fundamental variables more completely and thus their underlying imbalances.

There is an obvious inconsistency between the EU and Eurozone countries' fundamentals behavior before the crisis and the optimistic market reflection of the situation. If we look at the bonds'

---

<sup>5</sup> Equal to the market convention

yield behavior for the chosen countries from the EU we can see how they tightly converge in the whole pre-crisis and even crisis period when underlying fundamental imbalances were accumulated. The sudden reveal of the accumulated imbalances and the start of the crisis provoked significant market reactions and adjustments that resulted in the obvious and significant divergence.

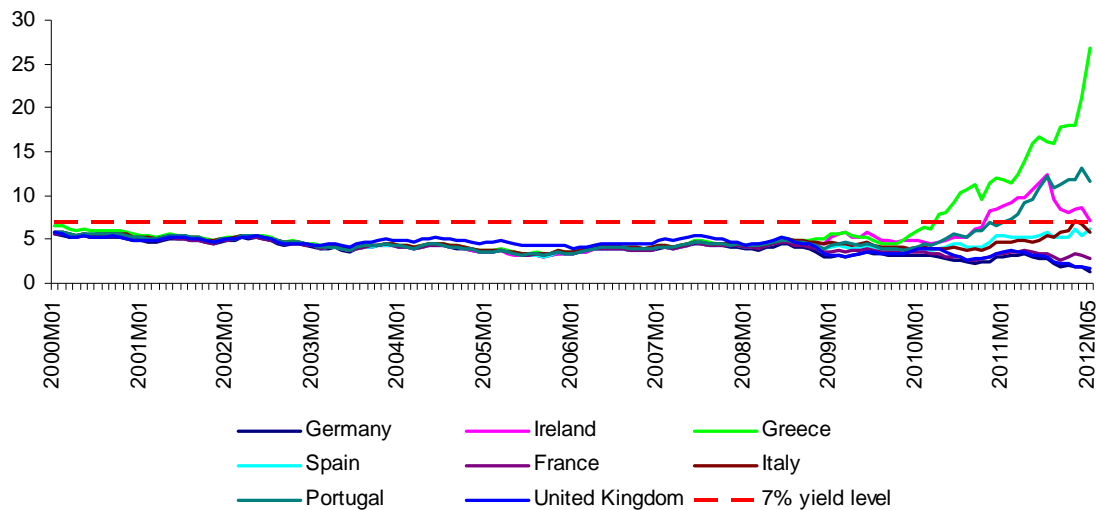

\* Central government bond yields on the secondary market, gross of tax, with around 10 years' residual maturity

Source: Author's presentation based on the Eurostat data

**Graph 5. Long term government bond yields (in %)\***

Fiscal deficit and debt increase should result in bond yields' increase (Schuknecht et al. 2008). However, in practice this reaction is often inelastic, nonlinear and marked with jumps when fiscal imbalance becomes significant. Some authors try to justify narrow spreads before 2009 with reduction in liquidity risk and expectation of bailouts in the case of crisis (Bernoth et al. 2004, Schuknecht et al. 2008). The spreads have significantly and suddenly broaden since the beginning of the debt crisis, although the imbalances were present for years. The elasticity of spreads related to fiscal imbalance has also increased. The following graph is based on the fiscal deficit and bond yield data for Eurozone core and periphery members in 2011. It shows the negative correlation (correlation coefficient of -0.64) between fiscal balance and yields where 1% increase in deficit leads to 0,7% increase in average bond yields.

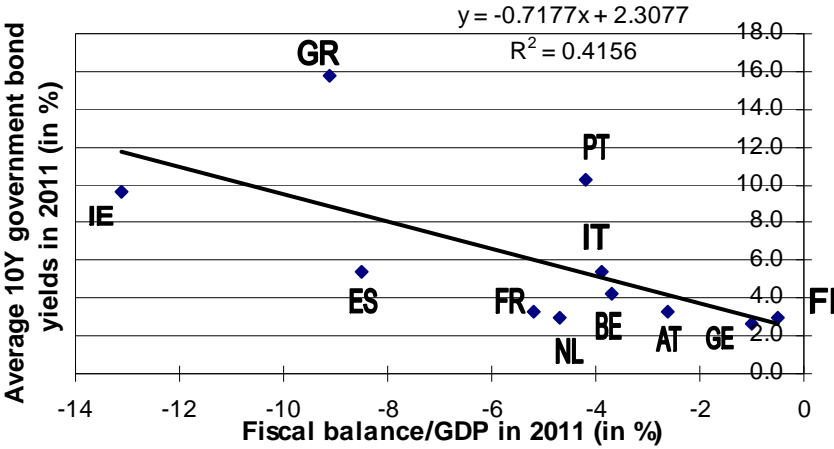

Source: Author’s presentation based on Eurostat data

**Graph 6. Fiscal deficit and bond yields for the core and periphery Eurozone countries in 2011**

The similar result is gain for connection between general government debt and yields (correlation coefficient of +0.85). The 1% increase in general government debt leads to 0.11% increase in average yields for the countries under consideration. Even this simple linear regression checks show that relations between fundamentals (especially fiscal) and bond yields are much clearer and stronger after than in the pre-crisis period<sup>6</sup>.

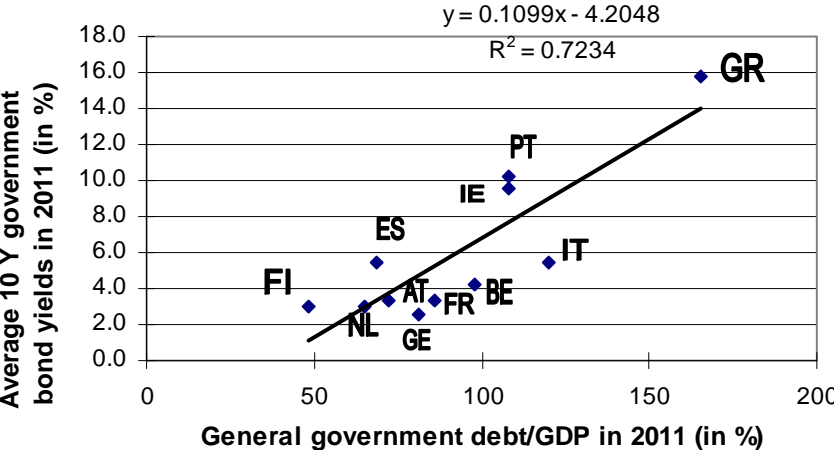

Source: Author’s presentation based on Eurostat’s data

**Graph 7. General government debt and bond yields for the core and periphery Eurozone countries in 2011**

<sup>6</sup> In order to compare ours with some pre-crisis results see e.g.: Barrios et al. (2010)

This can be regarded as a proof that markets did not adequately price the underlying risks, especially the credit risk that results from the underlying imbalances. As a consequence there was not enough discipline and market participants were even stimulated to use these favorable circumstances and additionally increase imbalances. The market reactivity increased after the crisis indicating the clearer link between fundamentals and yields' behavior.

### Empirical evidence of the CDS spreads behavior in the latest crisis

Empirical investigations concerning the CDS spread behavior before and during the crisis show that in developed countries and Eastern Europe spreads did not significantly change despite the fundamentals deterioration in the pre-crisis period. Accumulated imbalances were not well reflected in credit risk premium before the crisis, but most of them did after. Actually, before the crisis we have observed that periphery euro area countries and countries with fixed exchange rates that were expecting fast integration were facing reduction in CDS spreads irrespective of the behavior of their fundamentals (Alberola, E. et al. 2012, p. 28). For some other regions in the world, such as Asian and Latin American, the correlation between fundamentals and credit spread behavior during their crises was much more negative and higher. Only after the crisis markets suddenly punished European countries with bad fundamentals that was finally reflected in CDS spread divergence.

For an illustration we use 5-year sovereign Credit Default Swaps (CDS) premium as a proxy for credit risk. The following graph presents the 5-year CDS spreads for vulnerable periphery member states of the euro area: Greece, Ireland, Italy, Portugal and Spain. The sample period is from 02.05.2011 to 20.07.2012 and the data frequency is daily.

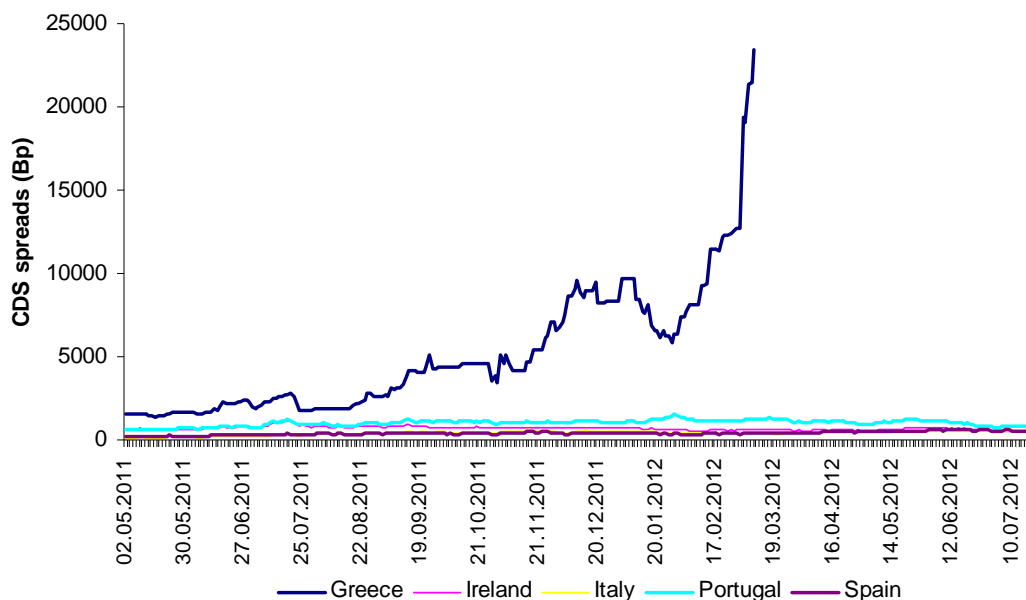

Source: Bloomberg

Graph 8. 5-year CDS spreads in euro area periphery

## CDS SPREADS, PROBABILITIES OF DEFAULT AND RISK PREMIUMS IN THE LATEST DEBT CRISIS

It indicates high divergence process even among the selected *red zone* periphery countries without taking into account credit spread behavior in more stabile core member states of the zone.

As expected, the CDS spreads react much faster in comparison to bond yields to default risk increase after the crisis although they showed similar inelastic behavior before the crisis. The same direction behavior of both types of spreads is not surprising since they depend on the similar set of fundamentals. The significant positive correlation is found between CDS spreads and bond yields in the 2003-2009 period for periphery euro area countries under consideration (Barrios et al. 2010). That may indicate that both types of spreads reacted similarly to expansionary environment and neglected the underlying imbalances.

The sensitivity of spreads changed after the crisis. In the whole sample period under consideration, the change in CDS spreads for Greece showed significant variability indicating financial and fundamental difficulties, followed by similar results for Italy, Spain, Portugal and Ireland, respectively.

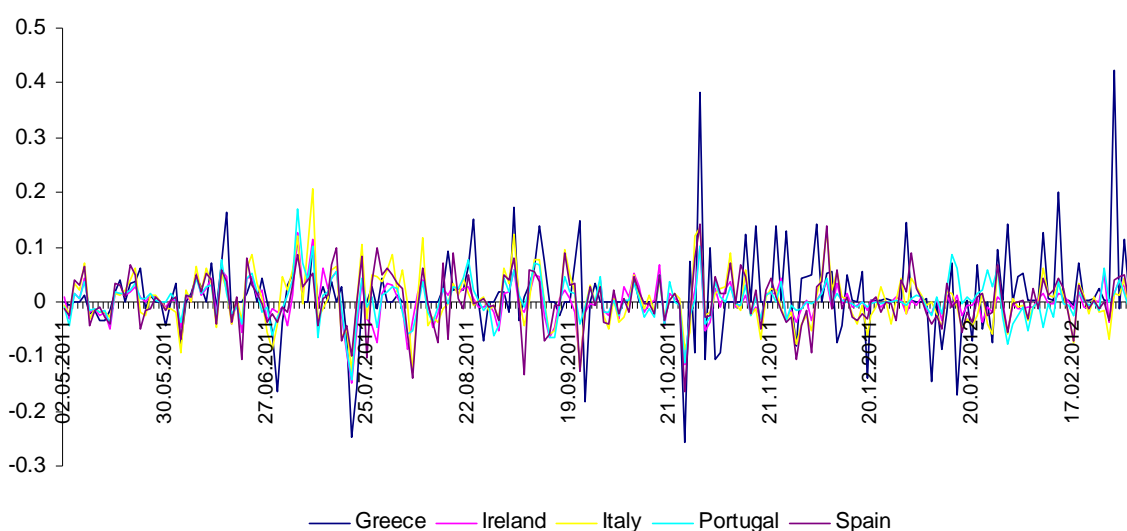

Source: Author's calculation based on Eurostat's data

**Graph 9. CDS spread changes in the sample period (ln)**

**Table 2. Mean and variability values for CDS spread changes in the Eurozone periphery, 02.05.2011 - 08.03.2012**

	Greece	Ireland	Italy	Portugal	Spain
Standard deviation	0.073928	0.034244	0.047712	0.036116	0.047193
Mean value	0.012667	-0.00032	0.004264	0.002883	0.002454

Source: Author's calculation based on Eurostat's data

Based on the market data on CDS spreads we have also calculated the implied probabilities of default for selected countries under recovery rate assumption of 40%. The



probabilities of default significantly increased after the crisis and especially in the previous year when the Greek crisis aggravated.

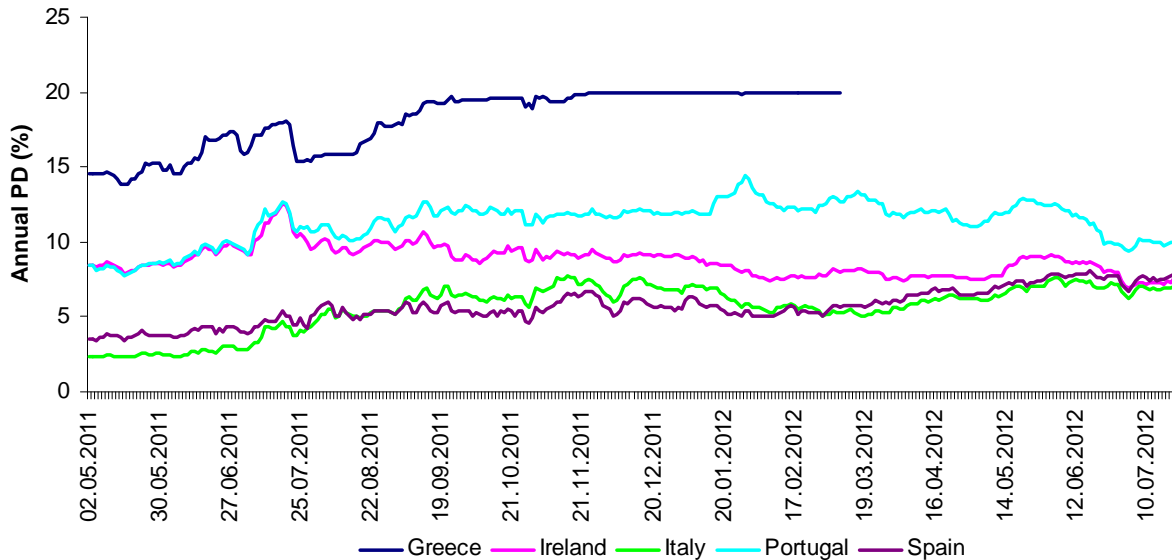

Source: Author's calculation based on Bloomberg's data

**Graph 10. Annual probabilities of default calculated from 5-year CDS spreads**

On March 9th 2012, Greece activated the Collective Action Clause (CAC) that had been inserted into its bonds. As a result, the ISDA<sup>7</sup> declared a triggering credit event. The CDS settlement auction was held on the 19th of March, until when most of the “old” bonds held by private investors had been exchanged for a package consisting of new Greek bonds, obligations of the European Financial Stability Facility (EFSF), and GDP-linked securities. The outstanding amount of Greek sovereign debt was reduced by approximately €100 billion. It became obvious that there might be not enough old bonds to allow a complete CDS settlement, and that the new bonds could become the cheapest-to-deliver. Luckily for CDS protection buyers, the new bonds traded at prices not far from the prices at which the old ones had traded just before the restructuring was announced. The CDS settlement auction discovered the price for deliverable bonds at €1.5 per €100 face value (Duffie, D. and M. Thukral, 2012).

The following table is based on 5-year CDS spreads of the periphery euro zone countries. It summarizes the CDS spreads and implied probability behavior for the selected countries. The sample period is from 02.05.2011 until 08.03.2012 and Greek activation of CAC. The data frequency is daily. The recovery rate is set to be equal to the market convention of 40%. Then for each country the average, the minimum value, and the maximum value of CDS spreads over the sample period was calculated to get the numbers reported. In each column the numbers on the right hand side represent the corresponding implied default probabilities as given by equation (6).

<sup>7</sup> ISDA –International Swaps and Derivatives Association

**Table 3. 5-year CDS spreads and implied default probabilities summary for period 2.5.2011-8.3.2012.**

Country	Average		Min		Max	
	Spread (Bp)	PD (%)	Spread (Bp)	PD (%)	Spread (Bp)	PD (%)
<b>Greece</b>	5085.393	18.2	1406	13.8	23389	20
<b>Ireland</b>	731.6729	9.1	558	7.4	1192	12.6
<b>Italy</b>	372.8131	5.3	144	2.3	592	7.8
<b>Portugal</b>	1005.383	11.2	594	7.8	1527	14.4
<b>Spain</b>	356.9673	5.1	226	3.4	491	6.7

*Source: Author's calculations*

What is obvious from the data and gained probabilities of default is the fact that markets disciplining effect has significantly increased after the global and during the ongoing debt crisis in Europe. The picture they provide now is much more realistic reflection of the financial and structural difficulties these countries face. What is expected from now on is that markets remain a valid disciplining mechanism especially but not only in times of financial distress.

### **Conclusions**

The latest world crisis shows some similarities to previous decades crises (in Latin America and Asia) in terms of macroeconomic and financial imbalances accumulation followed by inadequate economic policies and bad discipline. Similarly the latest crisis that prolonged in the form of debt crisis in Europe is represented by specific market reactions to credit and other risks accumulation in the pre-crisis period. The unique currency zone institutional framework, in circumstances of high global liquidity and expansion, unrealistically raised optimistic behavior of market participants. The countries that were the members or were on a way to Eurozone have seen its institutional and political framework as a good enough shield against possible shocks. The risk appetite has risen such as moral hazard behavior of agents and policymakers. That decreased discipline at all levels. Internal imbalances continued to accumulate. However, the crisis has shown the shortcomings of existing institutional framework for economic coordination, supervision and fiscal discipline. When internal imbalances fully emerged, the markets adjustments became severe and have strongly penalized these economies. That can be easily seen in credit spreads and bond yields significant divergence after the crisis and more elastic behavior regarding fundamentals. As it seems now, the market discipline is going to persist in the future.

The empirical investigations show that credit spreads and bond yields behavior is still largely based on economic principles despite certain deviations in the pre-crisis period. Secondly, the market penalizes fiscal imbalances more strongly after the crisis that can be seen in yield elasticity increase from 2009. Fiscal performances seem to be remaining as important differentiating factor in yield and CDS spread behavior in the future. The disciplining pressures coming from financial markets will certainly be much stronger in the future than they had been before the crisis.

In order to strengthen the EU and EMU institutional framework, important policy measures are implemented and announced to bring down fiscal deficits and address structural weaknesses in

vulnerable economies. Till now, euro area policymakers reached agreement on expanding the lending capacity of the European Financial Stability Facility and made more concrete moves towards the European Stability Mechanism. They have adopted a “fiscal compact” that aims to increase fiscal discipline and rebuild the authority of the Stability and Growth Pact. Despite these improvements, public finances remain weak in periphery countries combining high deficits, large debts and low growth. Fiscal consolidation has started in some countries but it requires years to be completed until when investors’ perceptions may easily shift and cause the increase in funding costs and default risk. Thus, what seems to be necessary is even stronger coordination between institutional reforms, national policy tightening and market discipline. In the medium term some forms of debt restructuring alternatives in the euro area together with banking union formation look like a necessary part of a debt crisis resolution mechanism and long term stabilization process.

### References

- Alberola, E., L. Molina and P. del Río (2012). Boom-bust Cycles, Imbalances and Discipline in Europe. *Documentos de Trabajo N.º 1220*. Madrid: Banco de España.
- Altman, E. I. et al. (2005). The link between default and recovery rates: theory, empirical evidence and implications. *Journal of Business*, 78, 2203-2227.
- Altman, E. I. (2009). Default Recovery Rates and LGD in Credit Risk Modeling and Practice. (10 July 2012) <<http://people.stern.nyu.edu/ealtman/UpdatedReviewofLiterature.pdf>>.
- Barrios, S. et al. (2010). Determinants of intra-euro area government bond spreads during the financial crisis. “Challenges for fiscal sustainability in the EU” - ECB Public Finance Workshop, Frankfurt January 2010.
- Bernoth, K., J. von Hagen and L. Schuknecht. (2004). Sovereign Risk Premia in the European Government Bond Market. *ECB Working Paper Series No. 369*. (21 July 2012) <<http://www.ecb.int/pub/pdf/scpwps/ecbwp369.pdf>>.
- Duffie D. and M. Thukral. (2012). Redesigning Credit Derivatives to Better Cover Sovereign Default Risk. *Working Paper No. 118*. Rock Center for Corporate Governance at Stanford University.
- Goldstein, M. et al. (1993). *International Capital Markets: Part I. Exchange Rate Management and International Capital Flows*. IMF World Economic and Financial Surveys. Washington, D. C.: International Monetary Fund.
- IMF. (2011). *Europe - Strengthening the Recovery*. Regional Economic Outlook, May 2011. Washington, D. C.: International Monetary Fund.
- IMF. (2012). *Global Financial Stability Report*. April 2012. Washington, D. C.: International Monetary Fund.
- Jaskowski M. (2011). Estimation of Implied Recovery Rates. A Case Study of the CDS Spreads Market. (17 June 2012) <<http://www.wu.ac.at/vgsf/students/eir.pdf>>.
- Schuknecht, L., J. von Hagen and G. Wolswijk. (2008). Government Risk Premiums in the Bond Market EMU and Canada. *ECB Working Paper Series No. 879*. (1 July 2012) <<http://www.ecb.int/pub/pdf/scpwps/ecbwp879.pdf>>.
- Schuknecht, L., J. von Hagen and G. Wolswijk. (2010). Government Bond Risk Premiums in the EU Revisited - The Impact of the Financial Crisis. *ECB Working Paper Series No. 1152*. (3 July 2012) <<http://www.ecb.int/pub/pdf/scpwps/ecbwp1152.pdf>>.
- <[www.bloomberg.com](http://www.bloomberg.com)>. (15 July 2012).



# THE APPLICATION OF FAIR VALUE TO BALANCE SHEET VALUATION OF STOCKS IN POLISH ECONOMIC REALITIES

Paweł Bielawski<sup>1</sup>

**Abstract:** *The valuation of financial instruments implicates a great number of problems not only in economics, but also in accountancy which aims to measure financial instruments from a practical perspective. The reason behind this problem is the way in which the concept of fair value is used to evaluate these complex assets. A broad category of financial instruments comprises two principal areas: instruments traded on the market and those for which active markets and, consequently, prices do not exist.*

*The former ones can be measured on the basis of accounting categories. The valuation of the latter ones requires the application of specific measurement models and techniques. The paper presents balance sheet valuation of public companies' stocks based on fair value, estimated by both financial markets and economic and financial modelling. The paper aims to present, through the use of statistics, the results of empirical research, and identifies the method which is more reliable for share valuation in Polish economic realities.*

**Keywords:** *accounting, financial instruments, fair value, balance sheet valuation, stocks.*

## Introduction

The main objective of the paper is to present the problems of share valuation models in accounting. The major source of controversy in this area is the concept of fair value. This new economic category introduced into accounting, being a substitute of market value and the future general valuation principle, does not only refer to the context of a market transaction – as is commonly believed – but also to a valuation based on an appropriate method or expert opinion. This concept makes a distinction between two basic categories of shares – those whose values are determined by active markets and those for which such markets and prices are not established.

The paper presents share valuation concepts based on general accounting principles, focusing on fair value determined by active markets as well as on share valuation based on the following models: DCF (*Discounted Cash Flow*), CAPM (*Capital Asset Pricing Model*) and HEV (*Historical Exchange Value*).

The last part of the paper refers to statistical methods to assess the practical application of balance sheet valuation models for listed companies representing two segments - 250+ companies (capitalization exceeding EUR 250m) and 5+ (capitalization from EUR 5m to EUR 50m).

## Balance sheet valuation of stocks in small and large companies from the point of view of fair value determined in active markets

Current accounting relies on a mixed model for valuing financial instruments. The solutions applied in accounting standards accept two methods for financial instrument valuation: historical costs and fair value accounting. Historical costs are applied in all accounting standards, and the use of international standards suggests that it is the most frequently adopted method in developing financial standards (IFRS 2007).

---

<sup>1</sup> Faculty of Management, Cracow University of Economics, bielawsp@uek.krakow.pl

## THE APPLICATION OF FAIR VALUE TO BALANCE SHEET VALUATION OF STOCKS IN POLISH ECONOMIC REALITIES

The mixed valuation model originates from the need to find an alternative valuation concept for accounting based on historical costs. Accounting theoreticians agree as to valuations based on historical costs and value (see: Wolk, Tearney 1997, Riahi-Belkaoui 2000, Surdykowska 2001, Hendriksen, Van Breda 2002). However, accounting faces the problem of choosing one category of value: fair value, market value, utility value, current values, etc. Fair value seems to be the final choice.

The fair value category in accounting is aimed to bring the measurements of the items included in financial statements closer to their actual value. This new economic concept, being a substitute of market value, does not only refer to the context of market transactions (as is commonly believed) but also to valuations based on specific methods, techniques and expert opinions. This concept makes a distinction between two basic categories of shares – those whose values are determined by active markets and those for which such markets and prices are not established. The most reliable fair value is determined by active markets. On the other hand, when valuation cannot rely on prices published in active markets (such prices do not exist), the valuation of shares is based on the estimation of fair value with the use of various valuation methods and techniques.

At the initial stage shares and other financial instruments are valued on the basis of their fair value. Afterwards, shares are measured at fair value. This category ensures the stability of balance sheet items. Continuous reliance on fair value and referring fair value directly to profits and losses facilitates the monitoring of income. If changes in fair value from period to period reflect active markets' operations, the fair value category does not pose any problems in the valuation process (see: Bielawski 2007, Bielawski 2008, Bielawski, Garlińska-Bielawska 2008).

Balance sheet valuation is based on the shares of small (5+ segment) and large (250+ segment) listed companies and they are classified as financial assets measured at fair value with profit and loss account changes. This classification indicates that shares at the balance sheet date (end-of year) will be measured at fair value on the basis of active market prices. Balance sheet share valuations at fair value at year-end are presented in Table 1.

**Table 1. Balance sheet valuations at fair value of 5+ and 250+ companies at year-end according to active market prices (PLN)**

Date	Vistula	Mostostal Zabrze	Mostostal export	Bytom	Próchnik	BRE	KGHM	BPH	ING Bank Śląski	Millenn ium
31.12.1998	9.65	13.00	4.15	4.50	9.15	84.00	12.50	208.00	182.00	3.15
31.12.1999	15.00	12.55	4.49	7.30	4.15	133.50	26.20	200.00	281.00	12.80
31.12.2000	8.35	9.00	5.00	4.51	1.76	131.00	25.80	235.00	235.00	6.70
31.12.2001	6.05	6.70	2.42	1.10	0.46	118.00	13.00	230.00	319.00	2.75
31.12.2002	2.00	1.23	1.23	0.99	0.21	88.00	13.50	271.50	383.00	3.30
31.12.2003	5.10	0.61	1.04	3.40	0.55	92.50	26.20	355.00	345.00	2.55
31.12.2004	31.00	0.83	1.39	13.20	1.40	114.00	31.30	510.00	389.00	3.36
31.12.2005	37.90	1.54	1.47	13.40	1.61	169.00	62.50	750.50	564.00	5.25
31.12.2006	90.00	4.11	2.89	20.20	0.86	336.00	89.00	926.50	768.00	7.95
31.12.2007	11.98	8.00	4.18	3.72	0.91	505.00	105.80	104.00	725.00	11.63

Source: author's calculations.

### Estimating balance sheet valuation – shares of small 5+ companies

The estimation of the value of shares of small 5+ companies is based on three models: DCF (Brealey, Myers 1991), (Kolb, Rodriguez 1992), (Jajuga, Jajuga 1998), (Luenberger 2003), HEV (Otnes, Enochs 1978), (Dobija 1995) and CAPM (Mossin 1966), (Sharpe 1964), (Lintner 1965).

Fair value measurements with the use of DCF, HEV and CAPM models are based on 1998-2007 share prices on a monthly basis (for each company  $t = 120$  observations). Fair value estimations are based on the shares of 5 companies listed on the Warsaw Stock exchange: Vistula, Mostostal Zabrze, Mostostal Export, Bytom and Próchnik. End-of-year balance sheet valuations at fair value are conducted at the end of each respective year (31.12.1998 - 31.12.2007). The estimations are also based on the following indicators: WIG annual rate of return, WIG20 annual rate of return, average monthly increase in WIG annual rate of return, average monthly increase in WIG20 annual rate of return, annual inflation rates and risk-free rate of return.

The first model for estimating fair value of listed shares is based on DCF. The DCF model is used in 6 variants. The discounting factors include the following (in the order of importance): WIG annual rate of return, WIG20 annual rate of return, average monthly increase in WIG annual rate of return, average monthly increase in WIG20 annual rate of return, annual inflation rates and risk-free rate of return.

The results of balance sheet valuations based on DCF are presented in Tables 2-4.

**Table 2. Estimating the value of shares – 5+ companies, based on DCF according to WIG annual rate of return and based on DCF according to WIG20 annual rate of return (PLN)**

Method	DCF, WIG annual rate of return					DCF, WIG20 annual rate of return					
	Date	Vistula	Mostostal Zabrze	Mostostal export	Bytom	Próchnik	Vistula	Mostostal Zabrze	Mostostal export	Bytom	Próchnik
	31.12.1998	7.67	16.65	6.75	14.02	12.36	7.24	15.72	6.37	13.23	11.66
	31.12.1999	13.64	18.37	5.87	6.36	12.93	13.91	18.73	5.98	6.48	13.19
	31.12.2000	14.80	12.39	4.43	7.20	4.10	15.23	12.74	4.56	7.41	4.21
	31.12.2001	6.51	7.02	3.90	3.52	1.37	5.56	5.99	3.33	3.00	1.17
	31.12.2002	6.24	6.91	2.50	1.14	0.47	5.89	6.52	2.35	1.07	0.45
	31.12.2003	2.90	1.78	1.78	1.43	0.30	2.68	1.65	1.65	1.33	0.28
	31.12.2004	6.52	0.78	1.33	4.35	0.70	6.35	0.76	1.30	4.23	0.69
	31.12.2005	41.43	1.11	1.86	17.64	1.87	41.98	1.12	1.88	17.88	1.90
	31.12.2006	53.67	2.18	2.08	18.97	2.28	46.90	1.91	1.82	16.58	1.99
	31.12.2007	99.35	4.54	3.19	22.30	0.95	94.67	4.32	3.04	21.25	0.90

*Source: author's calculations.*

**THE APPLICATION OF FAIR VALUE TO BALANCE SHEET VALUATION OF STOCKS IN POLISH ECONOMIC REALITIES**

**Table 3. Estimating the value of shares – 5+ companies, based on DCF according to monthly average increase in WIG annual rate of return and based on DCF according to monthly average increase in WIG20 annual rate of return (PLN)**

Method	DCF according to monthly average increase in WIG annual rate of return					DCF according to monthly average increase in WIG20 annual rate of return					
	Date	Vistula	Mostostal Zabrze	Mostostal export	Bytom	Próchnik	Vistula	Mostostal Zabrze	Mostostal export	Bytom	Próchnik
	31.12.1998	7.57	16.44	6.66	13.84	12.20	7.38	16.02	6.49	13.49	11.89
	31.12.1999	13.,4	18.37	5.87	6.36	12.93	13.91	18.73	5.98	6.48	13.19
	31.12.2000	14.80	12.39	4.43	7.20	4.10	15.23	12.74	4.56	7.41	4.21
	31.12.2001	6.51	7.02	3.90	3.52	1.37	5.56	5.99	3.33	3.00	1.17
	31.12.2002	6.24	6.91	2.50	1.14	0.47	5.89	6.52	2.35	1.07	0.45
	31.12.2003	2.90	1.78	1.78	1.43	0.30	2.68	1.65	1.65	1.33	0.28
	31.12.2004	6.52	0.78	1.33	4.35	0.70	6.35	0.76	1.30	4.23	0.69
	31.12.2005	41.43	1.11	1.86	17.64	1.87	41.98	1.12	1.88	17.88	1.90
	31.12.2006	53.67	2.18	2.08	18.97	2.28	46.90	1.91	1.82	16.58	1.99
	31.12.2007	99.35	4.54	3.19	22.30	0.95	94.67	4.32	3.04	21.25	0.90

Source: author's calculations.

**Table 4. Estimating the value of shares – 5+ companies, DCF according to risk-free annual rate of return and based on DCF according to annual inflation rate (PLN)**

Method	DCF according to risk-free annual rate of return					DCF according to annual inflation rate					
	Data	Vistula	Mostostal Zabrze	Mostostal export	Bytom	Próchnik	Vistula	Mostostal Zabrze	Mostostal export	Bytom	Próchnik
	31.12.1998	9.95	21.60	8.75	18.19	16.03	9.50	20.63	8.36	17.38	15.31
	31.12.1999	10.70	14.42	4.60	4.99	10.15	10.60	14.27	4.56	4.94	10.05
	31.12.2000	17.25	14.43	5.16	8.40	4.77	16.28	13.62	4.87	7.92	4.50
	31.12.2001	9.55	10.29	5.72	5.16	2.01	8.65	9.32	5.18	4.67	1.82
	31.12.2002	6.54	7.24	2.61	1.19	0.50	6.10	6.75	2.44	1.11	0.46
	31.12.2003	2.10	1.29	1.29	1.04	0.22	2.03	1.25	1.25	1.01	0.21
	31.12.2004	5.43	0.65	1.11	3.62	0.59	5.32	0.64	1.09	3.55	0.57
	31.12.2005	32.50	0.87	1.46	13.84	1.47	31.22	0.84	1.40	13.29	1.41
	31.12.2006	39.45	1.60	1.53	13.95	1.68	38.43	1.56	1.49	13.59	1.63
	31.12.2007	93.99	4.29	3.02	21.09	0.90	93.60	4.27	3.01	21.01	0.89

Source: author's calculations.



CAPM is another method for estimating the fair value of shares. CAPM expresses the expected rate of return on shares as the sum of risk-free rate of return and risk premiums. This model, apart from the fact that it simplifies economic reality, is based on strong foundations and it combines two most significant factors which determine the value of shares - the expected rate of return and risk.

The CAPM model is applied in two variants. The first one assumes that the market rate of return is based on WIG, which indicates that it refers to the entire market. The other variant is based on WIG20 as the market rate of return.

One-year interest on treasury bonds is treated here as risk-free rate of return. In the context of the above approaches to the market rate of return and risk-free rate of return, CAPM is used to estimate the expected rate of return which, in turn, provides a basis for valuing the shares of listed companies at year-end (1998-2007). The estimated share values based on CAPM as well as WIG and WIG20 annual rates of return are presented in Table 5.

**Table 5. Estimated share values – 5+ companies, based on CAPM according to WIG annual rate of return and based on CAPM according to WIG20 annual rate of return (PLN)**

Method	CAPM – WIG annual rate of return					CAPM - WIG20 annual rate of return					
	Date	Vistula	Mostostal Zabrze	Mostostal export	Bytom	Próchnik	Vistula	Mostostal Zabrze	Mostostal export	Bytom	Próchnik
	31.12.1998	(-)	9.96	5.82	2.29	6.66	(-)	6.88	5.04	(-)	4.18
	31.12.1999	25.72	23.72	6.45	10.21	17.25	28.12	25.21	6.75	11.05	18.39
	31.12.2000	4.73	9.62	4.09	3.85	3.05	6.27	10.21	4.22	4.41	3.26
	31.12.2001	(-)	2.60	3.06	(-)	0.38	(-)	(-)	2.00	(-)	(-)
	31.12.2002	5.04	6.48	2.44	0.99	0.44	3.00	5.44	2.21	0.71	0.36
	31.12.2003	6.17	2.44	2.01	2.54	0.43	5.23	2.18	1.84	2.19	0.38
	31.12.2004	11.03	0.96	1.43	6.40	0.89	10.44	0.93	1.40	6.11	0.86
	31.12.2005	78.23	1.43	2.04	28.35	2.50	84.09	1.51	2.12	30.22	2.63
	31.12.2006	112.20	2.96	2.34	33.12	3.22	79.98	2.36	1.98	24.63	2.53
	31.12.2007	121.43	4.87	3.27	25.69	1.03	97.72	4.37	3.05	21.72	0.92

(-) – Estimated balance sheet valuations based on the adopted method assume negative values.

Source: author's calculations.

The last method for estimating the fair value of shares is based on the historical exchange value. The HEV model is based on an analysis of historical trends in share prices the value of which is determined with the use of exponential smoothing. Fair value is estimated on the basis of two factors of the filtration process: inflation rates and risk-free rate of return. Assuming that smoothing coefficient  $\alpha$  should be dependent on inflation rates and risk-free rate of return, balance sheet valuation is calculated for the analysed period. The results are presented in Table 6.

**THE APPLICATION OF FAIR VALUE TO BALANCE SHEET VALUATION OF STOCKS IN POLISH ECONOMIC REALITIES**

**Table 6. Estimating share value – 5+ companies, based on HEV according to annual inflation rate and based on HEV according to risk-free rate of return (PLN)**

Method		HEV – annual inflation rate					HEV – risk-free annual rate of return				
Date	Vistula	Mostostal Zabrze	Mostostal export	Bytom	Próchnik	Vistula	Mostostal Zabrze	Mostostal export	Bytom	Próchnik	
31.12.1998	8.89	18.05	7.14	14.18	13.,32	8.97	17.56	6.85	13.23	12.91	
31.12.1999	10.61	12.92	4.21	5.00	8.,26	10.70	12.91	4.22	5.05	8.16	
31.12.2000	13.96	11.99	4.57	6.86	3.78	13.27	11.62	4.62	6.57	3.53	
31.12.2001	8.19	8.84	4.82	4.27	1.67	7.77	8.42	4.35	3.66	1.43	
31.12.2002	5.99	6.61	2.40	1.10	0.46	5.45	5.89	2.24	1.08	0.42	
31.12.2003	2.10	1.21	1.22	1.07	0.22	2.31	1.17	1.21	1.23	0.24	
31.12.2004	7.28	0.63	1.07	4.23	0.62	8.26	0.64	1.08	4.59	0.65	
31.12.2005	31.10	0.84	1.39	13.20	1.40	31.64	0.90	1.40	13.22	1.42	
31.12.2006	39.34	1.61	1.51	13.59	1.59	42.00	1.74	1.58	13.94	1.55	
31.12.2007	84.00	4.41	2.99	18.93	0.86	83.38	4.44	3.00	18.80	0.86	

Source: author's calculations.

**Estimating balance sheet valuation – shares of large 250+ companies**

The estimation of the share value of large 250+ listed companies is based on the same models as in the case of small companies: DCF, CAPM and HEV. The set of data comprises share values during the period of 10 years (1998-2007) on a monthly basis (for each company  $t = 120$  observations). Fair value is estimated on the basis of the shares of 5 companies listed on the Warsaw Stock Exchange: BRE, KGHM, BPH, ING Bank Śląski and Millennium. Balance sheet valuation at fair value based on DCF, CAPM and HEV is conducted at year-end (from 31.12.1998 to 31.12.2007).

At the first stage, the fair value of shares representing 250+ companies is estimated on the basis of the DCF model. Six variants of the model are applied as in the case of 5+ companies. Cash flows are discounted in the following order: WIG annual rate of return, WIG20 annual rate of return, average monthly increase in WIG annual rate of return, average increase in WIG20 annual rate of return, risk-free annual rate of return and annual inflation rate.

The results of estimated balance sheet valuations based on DCF are presented in Tables 7-9.

**Table 7. Estimating share value – 250+ companies based on DCF according to WIG annual rate of return and based on DCF according to WIG20 annual rate of return (PLN)**

Method	DCF – WIG annual rate of return					DCF – WIG20 annual rate of return				
Date	BRE	KGHM	BPH	ING Bank Śląski	Millennium	BRE	KGHM	BPH	ING Bank Śląski	Millennium
31.12.1998	67.91	9.99	176.14	192.79	3.02	64.10	9.43	166.25	181.97	2.85
31.12.1999	118.71	17.67	293.96	257.21	4.45	121.05	18.01	299.73	262.27	4.54
31.12.2000	131.76	25.86	197.39	277.33	12.63	135.56	26.60	203.09	285.33	13.00
31.12.2001	102.19	20.13	183.31	183.31	5.23	87.16	17.17	156.35	156.35	4.46
31.12.2002	121.77	13.42	237.34	329.18	2.84	114.81	12.65	223.78	310.37	2.68
31.12.2003	127.53	19.56	393.46	555.04	4.78	117.82	18.07	363.51	512.79	4.42
31.12.2004	118.34	33.52	454.17	441.38	3.26	115.21	32.63	442.18	429.72	3.18
31.12.2005	152.37	41.83	681.64	519.92	4.49	154.38	42.39	690.63	526.77	4.55
31.12.2006	239.31	88.50	1062.73	798.64	7.43	209.14	77.34	928.74	697.95	6.50
31.12.2007	370.90	98.25	1022.74	847.78	8.78	353.44	93.62	974.60	807.87	8.36

*Source: author's calculations.*

**Table 8. Estimating the value of shares – 250+ companies, DCF according to average monthly increase in WIG annual rate of return and based on DCF according to monthly average increase in WIG20 annual rate of return (PLN)**

Method	DCF – average monthly increase in WIG annual rate of return					DCF – monthly average increase in WIG20 annual rate of return				
Date	BRE	KGHM	BPH	ING Bank Śląski	Millennium	BRE	KGHM	BPH	ING Bank Śląski	Millennium
31.12.1998	67.04	9.86	173.88	190.32	2.98	65.34	9.61	169.46	185.48	2.91
31.12.1999	118.71	17.67	293.96	257.21	4.45	121.05	18.01	299.73	262.27	4.54
31.12.2000	131.76	25.86	197.39	277.33	12.63	135.56	26.60	203.09	285.33	13.00
31.12.2001	102.19	20.13	183.31	183.31	5.23	87.16	17.17	156.35	156.35	4.46
31.12.2002	121.77	13.42	237.34	329.18	2.84	114.81	12.65	223.78	310.37	2.68
31.12.2003	127.53	19.56	393.46	555.04	4.78	117.82	18.07	363.51	512.79	4.42
31.12.2004	118.34	33.52	454.17	441.38	3.26	115.21	32.63	442.18	429.72	3.18
31.12.2005	152.37	41.83	681.64	519.92	4.49	154.38	42.39	690.63	526.77	4.55
31.12.2006	239.31	88.50	1062.73	798.64	7.43	209.14	77.34	928.74	697.95	6.50
31.12.2007	370.90	98.25	1022.74	847.78	8.78	353.44	93.62	974.60	807.87	8.36

*Source: author's calculations.*

**THE APPLICATION OF FAIR VALUE TO BALANCE SHEET VALUATION OF STOCKS IN POLISH ECONOMIC REALITIES**

**Table 9. Estimating share value – 250+ companies, based on DCF according to risk-free annual rate of return and based on DCF according to inflation rate (PLN)**

Method	DCF – risk-free annual rate of return					DCF- annual inflation rate				
Date	BRE	KGHM	BPH	ING Bank Śląski	Millennium	BRE	KGHM	BPH	ING Bank Śląski	Millennium
31.12.1998	88.09	12.96	228.48	250.07	3.92	84.17	12.38	218.29	238.92	3.75
31.12.1999	93.18	13.87	230.73	201.89	3.49	92.23	13.73	228.38	199.84	3.46
31.12.2000	153.53	30.13	230.00	323.15	14.72	144.85	28.43	217.00	304.89	13.89
31.12.2001	149.77	29.50	268.68	268.68	7.66	135.72	26.73	243.46	243.46	6.94
31.12.2002	127.48	14.04	248.47	344.62	2.97	118.94	13.10	231.84	321.55	2.77
31.12.2003	92.58	14.20	285.62	402.92	3.47	89.50	13.73	276.12	389.51	3.36
31.12.2004	98.50	27.90	378.04	367.39	2.72	96.57	27.35	370.62	360.18	2.66
31.12.2005	119.51	32.81	534.63	407.79	3.52	114.80	31.52	513.57	391.72	3.38
31.12.2006	175.93	65.06	781.27	587.12	5.47	171.37	63.38	761.01	571.90	5.32
31.12.2007	350.88	92.94	967.54	802.02	8.30	349.44	92.56	963.56	798.72	8.27

Source: author's calculations.

CAPM is the other method applied in estimating the fair value of shares. The model is applied in two variants. The first one assumes that the market rate of return is based on WIG (and refers to the entire market). The other variant of CAPM relies on WIG20 as the market rate of return.

In the context of the above approaches to the market rate of return and risk-free rate of return, CAPM is used to estimate the expected rate of return which, in turn, provides a basis for valuing the shares of listed companies at year-end (1998-2007). The estimated share values based on CAPM as well as WIG and WIG20 annual rates of return are presented in Table 10.

The historical exchange value is the third concept applied in estimating the fair value of listed shares. The fair value of shares is estimated on the basis of two factors of exponential smoothing: inflation rate and risk-free rate of return. Assuming that smoothing coefficient  $\alpha$  should be dependent on inflation rates and risk-free rate of return, balance sheet valuation is calculated for the analysed period. The results of balance sheet valuations based on HEV are presented in Table 11.

The assessment of models for estimating balance sheet valuation of shares based on statistical methods

The obtained results provide a great deal of valuable and interesting information on the applied models for estimating balance sheet valuations of shares issued by large and small listed companies in the context of the comparability and reliability of their financial statements. The estimations are based on discounted cash flows, the historical exchange value and the capital asset pricing concept. The results of the estimated balance sheet valuations of shares in the analysed period are confronted against fair value measurements established in active markets in order to assess them on the basis of statistical methods. Assessments are based on two statistical measurements – the maximum and mean error (see: Aczel 2000).

**Table 10. Estimating share value – 250+ companies based on CAPM according to WIG annual rate of return and based on CAPM according to WIG20 annual rate of return WIG20 (PLN)**

Method	CAPM – WIG annual rate of return					CAPM – WIG20 annual rate of return				
Date	BRE	KGHM	BPH	ING Bank Śląski	Mille- nnium	BRE	KGHM	BPH	ING Bank Śląski	Mille- nnium
31.12.1998	61.06	4.36	131.80	167.53	1.17	53.92	2.09	106.26	145.73	0.44
31.12.1999	127.39	24.87	347.53	281.61	6.43	132.88	26.64	366.26	294.39	6.90
31.12.2000	124.36	17.76	169.76	257.13	8.32	127.93	19.27	177.14	265.21	9.10
31.12.2001	86.02	2.36	110.99	145.67	0.19	60.57	(-)	48.05	96.58	(-)
31.12.2002	119.83	12.22	227.92	322.38	2.56	109.43	9.75	199.97	292.14	2.01
31.12.2003	139.41	29.73	484.82	622.12	7.49	128.54	26.13	438.60	571.26	6.56
31.12.2004	125.08	44.17	518.67	474.00	4.39	122.31	42.48	504.01	462.89	4.22
31.12.2005	163.53	58.94	806.20	569.37	6.49	169.18	62.29	841.03	590.09	6.87
31.12.2006	260.85	132.95	1301.20	891.91	11.51	223.24	102.88	1070.92	756.92	8.83
31.12.2007	377.71	108.30	1069.51	867.96	9.76	354.53	95.03	981.40	810.98	8.50

(-) – Estimated balance sheet valuations based on the adopted method assume negative values.

Source: author's calculations.

**Table 11. Estimating share value – 250+ companies, HEV according to annual inflation rate and based on HEV according to risk-free annual rate of return (PLN)**

Method	HEV – annual inflation rate					HEV – risk-free annual rate of return				
Date	BRE	KGHM	BPH	ING Bank Śląski	Mille- nnium	BRE	KGHM	BPH	ING Bank Śląski	Mille- nnium
31.12.1998	78.53	11.57	202.11	213.98	3.40	79.06	11.66	202.68	210.86	3.38
31.12.1999	92.84	14.95	206.57	199.67	4.87	93.75	15.20	206.42	201.51	5.05
31.12.2000	133.11	26.14	205.48	273.79	11.84	132.85	26.10	209.13	269.00	11.21
31.12.2001	130.10	24.91	234.65	240.84	6.43	127.74	22.59	233.75	256.06	5.71
31.12.2002	117.52	13.01	230.66	320.02	2.76	113.54	13.07	236.17	328.51	2.83
31.12.2003	88.15	13.92	274.29	381.73	3.27	88.44	14.76	279.75	379.24	3.23
31.12.2004	94.31	26.63	368.07	348.71	2.62	95.12	26.82	373.89	350.36	2.65
31.12.2005	114.76	31.73	513.34	391.43	3.39	119.07	34.18	532.16	405.13	3.53
31.12.2006	173.61	63.23	755.36	569.63	5.32	182.15	64.59	764.36	580.07	5.46
31.12.2007	349.00	90.29	863.23	764.69	8.23	350.34	90.43	856.72	764.35	8.26

Source: author's calculations.

The first assessment method is based on comparing the mean errors of estimated balance sheet valuations determined by the adopted models. The assessments of fair value models for 250+ and 5+ companies based on the mean error are presented in Tables 12 and 14.

**THE APPLICATION OF FAIR VALUE TO BALANCE SHEET VALUATION OF STOCKS IN POLISH ECONOMIC REALITIES**

**Table 12. Assessment of models for estimating balance sheet share value – 250+ companies, mean error (%)**

Model	BRE	KGHM	BPH	ING Bank Śląski	Mille- nnium	Mean error (all companies)
DCF – WIG annual rate of return	2.82	5.72	87.16	4.63	13.45	22.76
DCF – WIG20 annual rate of return	7.32	11.05	78.51	0.04	7.13	20.81
DCF – average monthly increase in WIG annual rate of return	2.92	5.83	87.05	4.50	13.33	22.73
DCF – average monthly increase in WIG20 annual rate of return	7.17	10.91	78.66	0.15	7.31	20.84
DCF – annual risk-free rate of return	5.73	3.89	77.19	0.84	16.43	20.82
DCF – annual inflation rate	10.04	8.68	73.02	4.80	10.30	21.37
CAPM – WIG annual rate of return	1.83	9.20	95.61	7.05	7.30	24.20
CAPM – WIG20 annual rate of return	7.99	25.94	79.78	0.39	13.89	25.60
HEV – annual inflation rate	12.48	11.57	60.43	8.65	4.87	19.60
HEV – annual risk-free rate of return	12.39	12.22	60.76	7.91	1.98	19.05

*Source: author's calculations.*

The second method is based on the maximum error, i.e. a value between estimated measurements for 250+ and 5+ companies and the actual fair value. The assessments of models for estimating share value in the analysed period based on the maximum error are presented in Tables 13 and 15.

**Table 13. Assessment of models for estimating balance sheet share value – 250+ companies, maximum error (%)**

Model	BRE	KGHM	BPH	ING Bank Śląski	Mille- nnium	Maximum error (all companies)
DCF – WIG annual rate of return	38.37	54.81	883.41	60.88	90.05	883.41
DCF – WIG20 annual rate of return	37.76	32.18	837.11	50.99	93.99	837.11
DCF – average monthly increase in WIG annual rate of return	38.37	54.81	883.41	60.88	90.05	883.41
DCF – average monthly increase in WIG20 annual rate of return	37.76	32.18	837.11	50.99	93.99	837.11
DCF – annual risk-free rate of return	47.64	126.90	830.33	37.51	178.55	830.33
DCF – annual inflation rate	49.00	105.61	826.50	31.27	152.41	826.50
CAPM – WIG annual rate of return	50.71	81.88	928.38	80.32	193.84	928.38
CAPM – WIG20 annual rate of return	48.67	165.22	843.65	69.72	201.33	843.65
HEV – annual inflation rate	48.33	91.62	730.03	30.60	133.65	730.03
HEV – annual risk-free rate of return	45.79	73.78	723.77	28.29	107.63	723.77

*Source: author's calculations.*

**Table 14. Assessment of models for estimating balance sheet share value – 5+ companies, mean error (%)**

Model	Vistula	Mostostal Zabrze	Mostostal export	Bytom	Próchnik	Mean error (all companies)
DCF – WIG annual rate of return	84.36	64.70	28.79	89.31	79.51	69.33
DCF – WIG20 annual rate of return	76.24	56.60	22.20	78.59	70.12	60.75
DCF – average monthly increase in WIG annual rate of return	84.26	64.54	28.58	88.91	79.34	69.12
DCF – average monthly increase in WIG20 annual rate of return	76.38	56.83	22.50	79.16	70.36	61.05
DCF – annual risk-free rate of return	83.85	62.30	29.38	104.49	83.17	72.64
DCF – annual inflation rate	77.54	53.95	22.99	95.39	73.80	64.73
CAPM – WIG annual rate of return	86.47	67.96	28.51	46.57	73.82	60.67
CAPM – WIG20 annual rate of return	42.43	48.05	18.20	0.57	47.74	31.40
HEV – annual inflation rate	65.63	46.75	16.46	77.34	59.07	53.05
HEV – annual risk-free rate of return	62.20	39.58	12.95	69.48	50.58	46.96

Source: author's calculations.

**Tabela 15. Assessment of models for estimating balance sheet share value – 5+ companies, maximum error (%)**

Model	Vistula	Mostostal Zabrze	Mostostal export	Bytom	Próchnik	Maximum error (all companies)
DCF – WIG annual rate of return	729.29	462.11	103.03	499.42	211.60	729.29
DCF – WIG20 annual rate of return	690.25	429.97	91.42	471.20	217.72	690.25
DCF – average monthly increase in WIG annual rate of return	729.29	462.11	103.03	499.42	211.60	729.29
DCF – average monthly increase in WIG20 annual rate of return	690.25	429.97	91.42	471.20	217.72	690.25
DCF – annual risk-free rate of return	684.53	488.46	136.22	467.07	337.44	684.53
DCF – annual inflation rate	681.30	449.07	114.05	464.73	296.38	681.30
CAPM – WIG annual rate of return	913.60	426.46	98.61	590.49	315.66	913.60
CAPM – WIG20 annual rate of return	715.65	342.16	79.66	483.84	343.09	715.65
HEV – annual inflation rate	601.16	437.66	99.20	408.93	262.97	601.16
HEV – annual risk-free rate of return	596.00	378.60	82.37	405.43	211.76	596.00

Source: author's calculations.

## THE APPLICATION OF FAIR VALUE TO BALANCE SHEET VALUATION OF STOCKS IN POLISH ECONOMIC REALITIES

---

The assessment of estimating balance sheet valuations of shares on the basis of the maximum and mean error is based on the assumption that the best method is the one for which the maximum and mean errors have the lowest values.

The empirical results presented in Tables 12-15 lead to the conclusion that the HEV model based on the annual risk-free rate of return is characterised by the smallest maximum error for 250+ (723.7%) and 5+ companies (596.0%). Also, the HEV model based on the annual risk-free rate of return has the smallest mean error for 250+ companies (19.0%), while CAPM with WIG20 annual rate of return has the smallest error for 5+ companies (31.4%).

The results of the analysis indicate that in the periods of a steady increase in share values the HEV model with filtration based on the annual risk-free rate of return leads to estimations which are closest to the actual fair value. On the other hand, the remaining indicators used in estimating share value, including inflation rates, WIG index and average monthly increases in WIG and WIG20 indices demonstrate a lower level of correlation with balance sheet valuations of shares.

Further research of a larger number of companies in longer periods of time is likely to verify the assessment of models for estimating balance sheet valuations of shares and to test the applicability of the HEV model.

### Closing remarks

The valuation of shares and other financial instruments poses a number of problems in economic sciences, especially in accounting. These problems result from the application of the fair value category in share valuation. This concept makes a distinction between two basic types of shares: those for which prices are determined in active markets and those for which such prices and markets do not exist. The former shares are valued on the basis of accounting principles and categories. The valuation of the latter ones is based on valuation models and techniques.

The results presented in the paper indicate that if balance sheet valuations of shares cannot rely on accounting principles and categories – especially with regard to fair value based on active market prices – valuation methods and techniques should make use of the HEV model based on risk-free rate of return as well as CAPM based on WIG20 annual rate of return for 5+ companies (with the smallest mean error).

### References

- Aczel, D.A. (2000). *Statystyka w zarządzaniu*. Warszawa: PWN.
- Bielawski, P. (2007). Wycena bilansowa instrumentów finansowych na przykładzie strategii strangle. *Zeszyty Naukowe Uniwersytetu Ekonomicznego w Krakowie*, 752, 67-81.
- Bielawski, P. (2008). The Theoretical Structure of the Accounting of Financial Instruments – an Outline. In: *General Accounting Theory. Evolution and Design for Efficiency*, ed. I. Górski, Warsaw: Academic and Professional Press, 91-108.
- Bielawski, P. and J. Garlińska-Bielawska (2008). Metody wyceny instrumentów finansowych w świetle międzynarodowych standardów sprawozdawczości finansowej (MSSF). *Zeszyt Naukowy nr 8 Finanse i Bankowość*, WSZiB, 8, 98-110.
- Brealey, R.A. and S.C. Myers (1991). *Principles of Corporate Finance*. New York: McGraw-Hill.
- Dobija, M. (1995). Antyinflacyjna interpretacja zasady kosztu historycznego. *Zeszyty Teoretyczne Rady Naukowej SKwP*, 32, 49-57.
- Hendriksen, E.S., and M.F. Van Breda (2002). *Teoria rachunkowości*. Warszawa: PWN.



- Jajuga, K. and T. Jajuga (1998). *Inwestycje*. Warszawa: PWN.
- Kolb R.W. and R.J. Rodriguez (1992). *Principles of Finance*. Massachusetts, Lexington: D.C. Heath & Company.
- Lintner, J. (1965). Security Prices, Risk and Maximal Gains from Diversification. *The Journal of Finance*, 20, 587-615.
- Luenberger, D.G. (2003). *Teoria inwestycji finansowych*. Warszawa: PWN.
- Międzynarodowe Standardy Sprawozdawczości Finansowej (2007). Warszawa: IASB – SKwP.
- Mossin, J. (1966). Equilibrium in a Capital Asset Market. *Econometrica*, 34, 768-783.
- Otnes, K. and L. Enochs (1978). *Analiza numeryczna szeregów czasowych*. Warszawa: WNT.
- Riahi-Belkaoui, A. (2000). *Accounting Theory*. London: Business Press Thomson Learning.
- Sharpe, W.F. (1964). Capital Asset Prices: A Theory of Market Equilibrium Under Condition of Risk. *The Journal of Finance*, 19, 425-442.
- Surdykowska, S. (2001). Niektóre aspekty wprowadzenia wartości godziwej do polskiego systemu rachunkowości rozważane w międzynarodowym kontekście. *Zeszyty Teoretyczne Rachunkowości*, 4 (60), 196-207.
- Wolk, H.I., and M.G. Tearney (1997). *Accounting Theory – A Conceptual and Institutional Approach*. Cincinnati, Ohio: South-Western College Publishing.



# DIMENSIONALITY REDUCTION OF TIME SERIES DATA BASED ON SAX REPRESENTATION

Marina Milanović<sup>1</sup>

Milan Stamenković<sup>2</sup>

Zlata Đurić<sup>3</sup>

**Abstract:** *Time series data mining is a relatively new area of research in which the application of data mining methods is adapted to the temporal nature of the data. In today's organizations, a large amount of data is collected (and stored) everyday in the form of time series, which results in the increased use of time series and their proclamation (acceptance) as a valuable organizational resource. Efficient discovery of knowledge hidden in large data sets of high-dimensional time series data is based on the creation of approximation forms of the original series, which provide a concise representation and allow clear notion of their basic characteristics, with minimum loss of relevant information. In this Paper, the essential determinations of one, relatively recently proposed representation method, specifically designed for the needs of time series analysis, also known as the Symbolic Aggregate approXimation – SAX representation, are presented.*

**Keywords:** *Time series data mining, dimensionality reduction, symbolic approximation, SAX representation, MINDIST function*

## Introduction

The development of information technology and the increase of computer power have enabled storage of huge amounts of (structured and unstructured) data, generated as a result of performing daily activities in literally all areas of life and business. Consequently, it is often said that today's organizations are drowning in a sea of data but at the same time, thirsty for knowledge and information, so that the mining of these data can be seen as a mine of interesting research challenges.

Through the application of data mining methods in business and research, a number of problems regarding temporal aspect are being successfully solved. Since time series are the most common form of presenting the temporal data, the application of data mining methods in their analysis led to the development of a concept known as *Time Series Data Mining (TSDM)*. In the last decades, numerous *TSDM* methods for the extraction of hidden patterns, unexpected trends, and other subtle relationships in the time series data, have been proposed. These methods have been successfully applied in characterizing and predicting complex, non-stationary, and even chaotic time series from different domains.

Extremely large data sets, high dimensionality, and continuous updating are essential characteristics of time series. Generally, an individual numeric value of each data point in time series is not in a research focus, but rather hidden trends, rules and regularities present in the movement of the phenomenon, presented by the particular series. The fundamental problem is how to present (display) time series data that possess properties mentioned above. In such circumstances, the

---

<sup>1</sup> Faculty of Economics, University of Kragujevac

<sup>2</sup> Faculty of Economics, University of Kragujevac, m.stamenkovic@kg.ac.rs

<sup>3</sup> Faculty of Economics, University of Kragujevac

appropriate transformation of the original data into representations of lower order of dimensionality enables efficient storage, transfer, visualization and processing of time series data, so that the analysis is redirected from the original data to the analysis of their high-quality abstractions.

Starting from the aforementioned, the aim of this Paper is to emphasize the importance of approximate representation of time series in function of dimensionality reduction and implementation of *TSDM* tasks. In addition, the diversity of developed approaches is pointed out, and the demonstration of the *SAX* method for dimensionality reduction is provided. With the *Introduction* as *Section 1*, the rest of the Paper is organized as follows. In *Section 2*, the issues regarding the similarity search in time series data, as well as the role of times series representations for the reduction of their inherent dimensionality are briefly discussed. In *Section 3*, the role of symbolization in the identification of temporal, dynamic patterns is analyzed. Within the *Section 4*, the *SAX* representation method is presented, particularly the version of *SAX* known as the *classic SAX*. The issues regarding the comparison of two *SAX* representations are discussed in *Section 5*. The last section contains concluding remarks and possible directions for future research.

### **Representation methods of time series data**

In various business and research areas, application of data mining methods enables and provides solutions to a wide range of problems that include temporal dimension. Therefore, the analysis of time series in data mining context is an attractive scientific-research area subjected to the constant changes. Consequently, *TSDM* is, according to different criteria, highly complex research area, and therefore, it is practically impossible to consider and fully discuss about all relevant issues in one place.

According to the relevant literature, referring to the *TSDM* field, one of the key aspects in the context of data mining of time series data is the analysis of the main tasks of *TSDM* methods. The expanded list includes the following *TSDM* tasks (Keogh and Kasetty, 2002; Ratanamahatana et al. 2005a; Lin et al. 2005; Mörchen, 2006; Lin et al. 2007; Chundi and Rosenkrantz, 2009; and Keogh, 2010): *preprocessing*, *indexing*, *clustering*, *classification*, *segmentation*, *anomaly detection*, *motif discovery*, *rule discovery*, *visualization*, and *prediction* (i.e. *forecasting*). In order to achieve and ensure sophisticated results from data mining applications in solving real problems, it is generally necessary to use and rely on the various combinations of *TSDM* tasks. Most of these tasks involve (i.e. rely on) searching for similar patterns of behavior that are hidden in huge amounts of raw data. In fact, at the core of these tasks lies the similarity search in the behavior of the time series.

Accordingly, the first fundamental question that arises in the implementation of any *TSDM* task is how to quantify the proximity, i.e. how to measure the similarity between time series. In the literature, various measures have been proposed for measuring similarity between time series (for details, see Mörchen, 2006; and Zezula et al. 2006). In addition, a thorough tutorial on similarity measures along with other *TSDM* related issues is provided in Gunopoulos and Das (2000). As the most straightforward and commonly used similarity measures, the *Euclidean distance* (and its variants, based on the common *L<sub>p</sub>-norms*), (Yi and Faloutsos, 2000), *Dynamic Time Warping (DTW)*, (Berndt and Clifford, 1994), and *Longest Common Subsequence (LCSS)*, (Vlachos et al. 2002), are emphasized. Basically, the selection of a particular methodological basis as well as a measure for the determination of similarity is made according to the characteristics of time series that are being compared (the length of time series, the presence of outliers and noises, previously available researcher's knowledge about the structure of data, etc.). In addition, the selection of a specific measure is conditioned also by the type of similarity that is the subject of particular examination (Ratanamahatana et al. 2005b), and in this context, different types of similarity can be categorized in the following groups: *similarity in time*, *similarity in shape*, and *structural similarity*.

Key characteristics of many time series are their enormous size (which can vary from a few megabytes to several terabytes), high dimensionality and, in the digital age, continuous updating, which permanently refreshes and enhances the existing databases. Valid analysis of such large, high dimensional data sets is often impossible to perform without a substantial jeopardizing of not only the efficiency, but also the outcome and procedure of similarity searching. Thus, another (second) fundamental question that arises in the implementation of any *TSDM* task is how to compress time series, and at the same time ensure that the key characteristics of the observed series are identified. Basically, the main objective is to carry out the reduction of high dimensionality of time series and successfully deal with the phenomenon known as the “*curse of dimensionality*”.

Therefore, similarity search is in a direct conceptual relation with the reduction of the inherent dimensionality of huge amounts of temporal data stored in appropriate repositories. The underlying idea of dimensionality reduction is to display the observed time series in the form different from the original data, through appropriate approximation forms that provide concise representation and allow clear notion of their basic characteristics, with minimal loss of relevant information. Representation of time series is a transformation technique that maps the time series of high dimensionality from the original space into the reduced space of lower order of dimensionality. In concrete data mining applications, expert data analysis within the new, reduced dimensions provides similar or even the same solutions compared to those that would be obtained if the original data were used in the analysis.

Many dimensionality reduction techniques, also known as the *representation methods* of time series, have been proposed in the relevant literature. Within the data mining context, one of the first proposed representations was the *Discrete Fourier Transform (DFT)*, (Agrawal et al. 1993). For detailed insight into the hierarchical classification and description of certain categories of representations, proposed to support similarity search and time series data mining, interested readers are referred to Mörchen (2006), Keogh (2010), and Ratanamahatana et al. (2005b), and their reference sections. Generally, the selection of appropriate representation is strongly influenced by the particular data mining task and similarity search objective, including the characteristics of the observed time series.

Special category of representation, which has recently become the subject of intensive interest are symbolic representations. Transformation of original, raw time series data into symbols can be achieved by using different methods. Detailed description and discussion regarding the idea that lies at the basis of one such symbolic method, known as the *Symbolic Aggregate approximation - SAX* method, proposed by Lin et al. (2003) will be presented in the following text.

### **The significance of symbolization in identifying temporal patterns**

Symbolization, as a pre-processing step in the analysis of time series, is used in various application areas for identification of temporal patterns in experimental data. It is defined as the process of converting real-valued data of the original time series into a series of symbols. In this way, a new, corresponding symbolic series is formed, which becomes a subject of further processing directed at successful extraction of relevant information and rules. Independently from the method used for the transformation of raw data into symbols, it is necessary to emphasize the following three parameters, relevant in terms of performance evaluation of every symbolic method: *alphabet size*, *information loss*, and *compression ratio*.

Symbolization is a way of representing data using *strings*, also called *symbol sequences*, or *words*. Mostly, symbolic representation of time series uses an alphabet to reduce the dimensionality of the time series, and the number of symbols is called the alphabet size (in the literature this term is also referred to as a *symbol-set size*, (Daw et al. 2003)). For example, in the simplest, binary case, there are

## **DIMENSIONALITY REDUCTION OF TIME SERIES DATA BASED ON SAX REPRESENTATION**

only two possible symbols {0,1}, and alphabet size is 2, or, if the used symbols of an alphabet are {a, b, c, d}, than the alphabet size is 4.

In the extreme case, when the size of an alphabet is equal to the number of individual values within the original time series, a series of symbols and the original series are equivalent in terms that they possess the same degree of precision and contain the identical information. In other words, in this case there is no information loss, which usually occurs as a consequence of the symbolic transformation. However, in reality, usually the number of symbols is much smaller than the number of different values in the original series, so it can be stated that the symbolization is always accompanied with a certain loss of information. Therefore, the researcher inevitably makes the decision (choice) regarding the number of symbols, i.e. decides about the size of an alphabet, which directly affects the quality and characteristics of the symbolic representation of data. Although some researchers try to optimize this procedure, the selection of appropriate alphabet size is mainly an empirical issue, where it is necessary to consider the trade-off between the information loss and the complexity of the analysis (Sant' Anna and Wickström, 2011).

The key assumption that underlies symbolization is that symbolization simplifies time series while retaining its key temporal characteristics, enabling the discovery of regularities in its behavior. In this context, in order to provide the identification of meaningful information about the dynamics of the observed phenomenon over time, an important question concerns the choice of the length of symbolization interval, which defines the number of real data points between consecutive symbols. Therefore, it is necessary first to divide the time series into a certain number of consecutive, internally homogeneous pieces, i.e. segments, and then, to assign a corresponding symbol to each of the formed segments, depending on which region particular segment belongs to. Thus, it can be pointed out that the segmentation of time series is the essential component of the symbolization process. Through the process of segmentation, data compression is achieved, i.e. the size of the observed data sets as well as inherently present high dimensionality is being reduced. The performance of conducted compression is evaluated using different measures. One of them is the *compression ratio* (Salomon and Motta, 2010), which is defined as:

$$\text{Compression ratio} = \frac{\text{size of the output stream}}{\text{size of the input stream}}, \text{ or, } \text{Compression ratio} = \frac{\text{dimension of the reduced space}}{\text{dimension of the original space}}$$

For the detection of temporal patterns (if any exist), in determining the number of segments, and thus the length of symbolic sequence, researcher's expert evaluation, usually plays a dominant role.

Presenting key characteristics of time series data in the form of symbolic sequence not only facilitates identification of hidden temporal patterns but significantly increases the efficiency of numerical computations in comparison to those that would be performed on the original data. In addition, the analysis of symbolic data is often less sensitive to the presence of noise in the data, so that the deterministic characteristics can be quantified with a greater precision. The positive effects of symbolic representation are also, often, manifested in the reduction of engaged computer resources, required in terms of storage capacity. Accordingly, the application of symbolization provides robustness of the post-symbolic analysis to the presence of noise, increased processing speed, as well as the reduction of associated costs. Consequently, symbolization is a useful method for *TSDM*, because it enables researchers to use a wide range of techniques designed for handling, primarily, symbolic time series, which are not originally defined for work with the real-valued time sequences. In that way, it increases the analytical capabilities and expands the horizons of researchers in the realization of *TSDM* tasks.

### SAX representation of time series

Group of time series representation, which involve symbolic representations, is numerous and broad. Of all the symbolic representation methods in time series data mining literature, the *Symbolic Aggregate approxIimation method* (SAX) stands out as the most powerful symbolic representation method. SAX representation is based on the *Piecewise Aggregate Approximation* (i.e. *PAA representation*), and the assumption that time series are normally distributed. As noted in Lin et al. (2003), and Lin et al. (2007), this method is characterized by two important advantages:

- *Dimensionality reduction*: The dimensionality reduction achieved through *PAA* representation is automatically carried over to *SAX* representation.
- *Lower bounding of distance measure*: It has been shown that a distance measure between two symbolic strings created by *SAX* lower bounds the true distance between the two original time-series.

Converting the original time series into *SAX* approximation implies the reduction of time series of length  $n$ , into the string, sequence (of symbols) of length  $k$ , where  $k < n$  (typically,  $k \ll n$ ). The procedure of providing this symbolic approximation consists of steps presented in *Figure 1*. In addition, *Table 1* presents a list of symbols used in this paper for the explanation of the idea underlying *SAX* approach. Empirical demonstration of the presented idea will be carried out on the example of time series consisting of 1260 data about daily movement of values of stock exchange index *BELEX-15*, as the leading Belgrade stock exchange index that describes the movement of stock prices of 15 most liquid Serbian companies, (*Figure 2: left*).

As the *SAX* method applies only to the standardized series, in the *first step*, the transformation of the original time series is performed through the  $z$ -standardization process, in its standardized form (*Figure 2: right*), with the arithmetic mean 0, and standard deviation 1, symbolically:  $[Y \rightarrow Y': N(0,1)]$ . The implementation of the next steps is based on the basic properties of the standardized normal distribution.

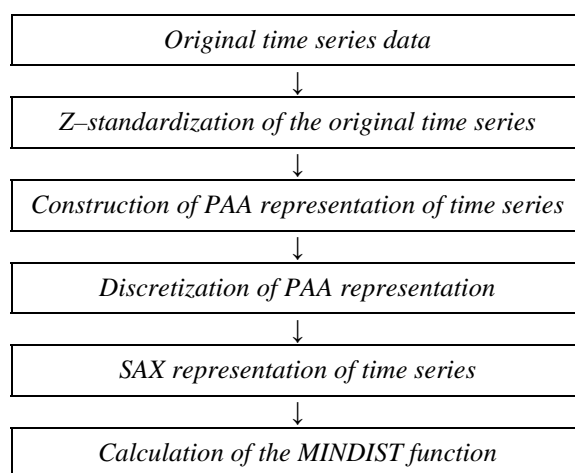

**Figure 1: Steps in the construction of SAX representation of time series**

**Table 1: Symbols used in the paper and their descriptions**

Symbols	Descriptions
$Y$	original time series: $Y = y_1, y_2, \dots, y_n$
$Y'$	standardized version of time series: $Y' = y'_1, y'_2, \dots, y'_n$
$\bar{Y}'$	PAA representation of time series: $\bar{Y}' = \bar{y}'_1, \bar{y}'_2, \dots, \bar{y}'_k$
$\hat{Y}$	SAX representation of time series: $\hat{Y}' = \hat{y}'_1, \hat{y}'_2, \dots, \hat{y}'_k$
$n$	size, i.e. length of time series $Y$
$k$	number of PAA segments (i.e. PAA coefficients)
$\alpha$	size of an alphabet (e.g., for an alphabet {a,b,c,d}, $\alpha = 4$ )
$S_h$	$h^{\text{th}}$ symbol of an alphabet $S$ , $h=1, 2, \dots, \alpha$ (e.g. for $\alpha=4$ , $S_1=a, S_2=b, S_3=c, S_4=d$ )
$\beta_i$	breakpoints ( $i=1, \dots, \alpha-1$ )

In the *second step*, the dimensionality of the time series is reduced through the representation form that is based on *Piecewise Aggregate Approximation (PAA)* representation of the standardized series. With respect to the fact that the *SAX* representation is derived from the *PAA* representation, a brief overview of this, in terms of computation, simple and efficient method, proposed by Keogh et al. (2000), and Yi and Faloutsos, (2000), independently from each other, follows. Through the *PAA* technique, time series,  $Y'$ , of length  $n$ , is segmented into  $k$  consecutive pieces of equal size, where, for each of the formed segments, the arithmetic mean is calculated using the following formula:

$$\bar{y}'_j = \frac{k}{n} \sum_{i=\frac{n}{k}(j-1)+1}^{\frac{n}{k}j} y'_i, \text{ for } i = 1, 2, \dots, n, \text{ and } j = 1, 2, \dots, k. \quad (1)$$

The series of formed  $k$  arithmetic means (also called the *PAA coefficients*), presents a new, reduced representation of time series. In fact, symbolically, the  $n$ -dimensional series,  $Y = y_1, y_2, \dots, y_n$ , is represented by  $k$ -dimensional series,  $\bar{Y}' = \bar{y}'_1, \bar{y}'_2, \dots, \bar{y}'_k$ , (where  $k \ll n$ ), (see, *Figure 3*). The optimal value of parameter  $k$  lies between following extreme cases: when  $k = 1$ , the time series is mapped into its average value, and, when  $k = n$ , the time series is not transformed, and therefore, dimensionality reduction is not achieved. In determining the optimal value of the parameter  $k$ , the researcher's expert assessment (opinion) plays a dominant role. The relation  $n/k$  expresses the number of data points that constitute each segment, while the relation  $k/n$  represents the *compression ratio*. As a secondary (intermediate) representation between the original time series and symbolic representation, the *PAA* representation results with the approximated series, which in the form of straight lines, is presented in *Figure 4*.



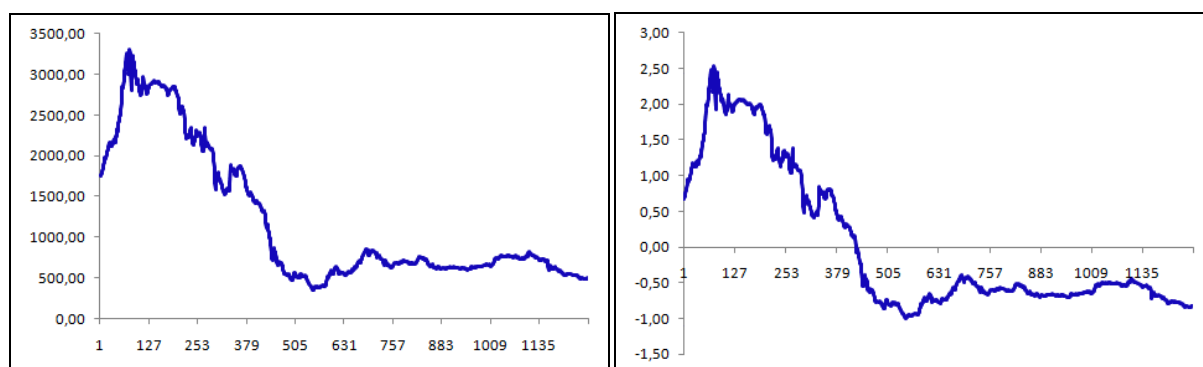

Figure 2: Original time series (left) and its z-standardized form (right)

[Source of data: [www.belex.rs](http://www.belex.rs)]

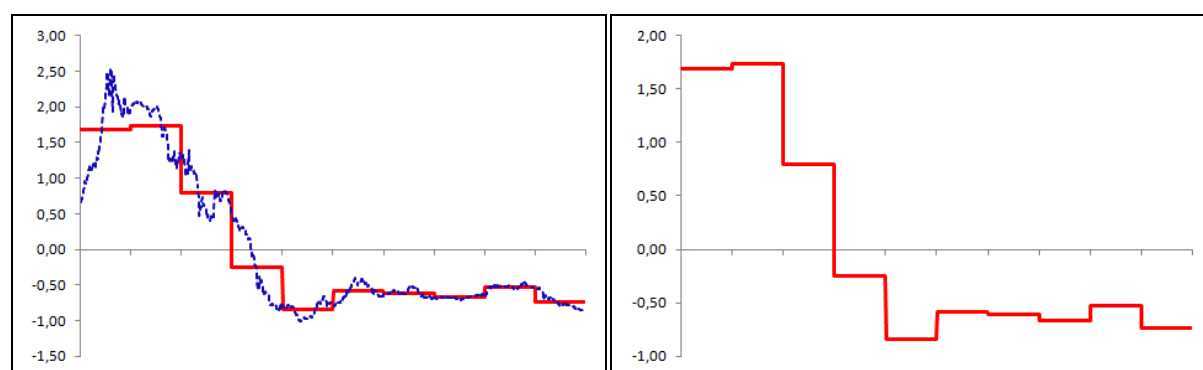

Figure 3: Z-standardized form of time series vs. PAA representation      Figure 4: PAA representation of time series

After the transformation of time series into the *PAA* representation, within the *third step*, further transformation is performed in order to provide a symbolic representation. The conversion of numeric time series into a series of symbols is called *discretization* (or *symbolization*). The process of discretization begins by the determination of the *size of an alphabet*, i.e. the *number of symbols* that will be used for the construction of symbolic representation of time series. Alphabet size is an arbitrary determined integer value, marked with the symbol  $\alpha$ , where the relation  $\alpha > 2$  must always be satisfied. In addition, each symbol has an equal and independent probability of occurrence. Previously stated comes from the fact that the observed time series was standardized in the first step,  $Y'$ :  $N(0;1)$ . In fact, depending on the size of an alphabet, in the normal distribution graph (*Gaussian curve*), it is possible to determine  $\alpha-1$  *breakpoints*,  $\beta_i$ , (for  $i=1, \dots, \alpha-1$ ), which will produce  $\alpha$  equal-sized areas under *Gaussian curve*, where, to each of those areas, the appropriate symbol,  $S_h$ , (for  $h=1, 2, \dots, \alpha$ ), will be assigned. In addition, the area under the normal curve, between two consecutive breakpoints  $\beta_i$  (from  $\beta_i$  to  $\beta_{i+1}$ ) is equal to  $1/\alpha$ , and  $\beta_0$  and  $\beta_\alpha$  are defined as  $-\infty$  and  $+\infty$ , respectively. Therefore, the number of breakpoints depends on the size of an alphabet, and the value (location) of each breakpoint is determined using the standardized normal distribution table. *Table 2* presents the values of breakpoints for different alphabet size,  $\alpha$ .

Finally, after the determination of breakpoints, to each of the computed *PAA* coefficients the appropriate symbol,  $S_h$ , is assigned, according to the interval between two consecutive breakpoints (i.e. area under the normal curve) under which each of the *PAA* coefficients falls in (*Figure 5*). Thus, the

discretization of the *PAA* coefficients ( $\bar{y}_j$ , for  $j=1,2,\dots, k$ ) into *SAX* symbols ( $\hat{y}'_j$ , for  $j=1,2,\dots, k$ ) is performed, with respect to the following rules: all *PAA* coefficients that are below the smallest breakpoint ( $\beta_1$ ) are mapped to the symbol “a”, ( $S_1$ ). All coefficients that are greater than or equal to the smallest breakpoint ( $\beta_1$ ), and less than the second smallest breakpoint ( $\beta_2$ ), are mapped to the symbol “b”, ( $S_2$ ), etc.

**Table 2: Breakpoint values**

Breakpoints	Size of an alphabet, $\alpha$					
	3	4	5	6	7	8
$\beta_1$	-0,43	-0,67	-0,84	-0,97	-1,07	-1,15
$\beta_2$	0,43	0	-0,25	-0,43	-0,57	-0,67
$\beta_3$		0,67	0,25	0	-0,18	-0,32
$\beta_4$			0,84	0,43	0,18	0
$\beta_5$				0,97	0,57	0,32
$\beta_6$					1,07	0,67
$\beta_7$						1,15

The combination of these symbols is called *SAX word*, i.e. symbolically:  $\hat{Y}' = \hat{y}'_1, \hat{y}'_2, \dots, \hat{y}'_k$ . In this way, in the form of *SAX word*, the *SAX representation* of time series is defined (Figure 6). The original time series, which consists of 1260 data, is transformed into the *SAX word* “*dddabbbbba*”, for the size of an alphabet  $\alpha = 4$ . Therefore, the number of symbols in *SAX word* is determined by the number of segments, and content of the *SAX word* for the same time sequence can differ depending on the selected alphabet size.

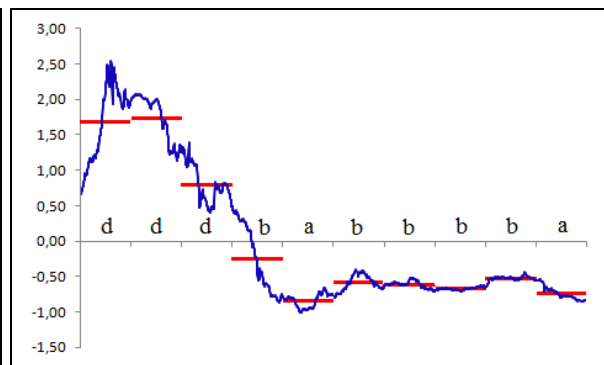
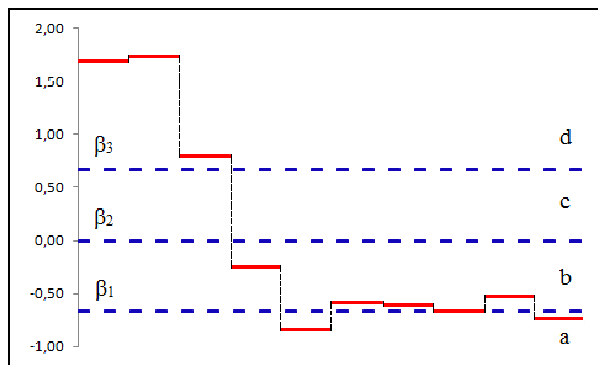

**Figure 5: Discretization process for  $\alpha = 4$       Figure 6: SAX word – „dddabbbbba“**

Feature extraction through the representation of time series with a small number of symbols significantly contributes to the improvement of performance of similarity search, which is the core activity in solving data mining problems. Therefore, the *last step* of *SAX* method is the calculation of appropriate similarity measure and its use in the implementation of (classical, as well as specific) *TSDM* tasks, such as, clustering, classification, similarity search, detection of anomalous patterns, motif discovery, and visualization.

### 5. Comparing two time series represented by SAX

It has already been pointed out that *SAX* is the first symbolic representation of time series data with an approximate distance function that *lower-bounds* the true distance between the two original time series. In this context, the question of defining a distance measure of this new representation arises. For the analysis of the aforementioned question, besides the already described (introduced) time series, *BELEX-15*, one more time series, which contains 1260 data about daily stock price movement of the company *IMLEK a. d. Belgrade*, as a leading company in the industry of milk and dairy products, is used. In *Figure 7*, these time series are presented in their standardized forms, where *Y* refers to the *BELEX-15* time series, and *X* refers to the *IMLEK* time series.

In addition, the starting fact is that the most common distance measure for the time series similarity search is Euclidean distance, (Chiu et al. 2003; Keogh and Kasetty, 2002; and Reinert et al. 2000). The *Euclidean distance* between two time series, *X* and *Y*, of equal length *n*, is defined as:

$$D(Y', X') = \sqrt{\sum_{i=1}^n (y'_i - x'_i)^2}, \quad (2)$$

where *X'* and *Y'* are standardized forms of the original time series. Therefore, the Euclidean distance between two time series is defined as the square root of the sum of squared differences of each pair of corresponding data points. *Figure 8(A)*, illustrates the visual intuition of this measure.

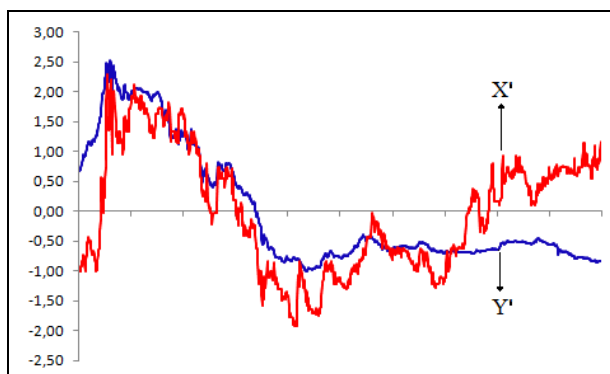

**Figure 7: Z-standardized forms of original time series**

[Source of data: [www.belex.rs](http://www.belex.rs)]

After the transformation of the original time series into the *PAA* representation, i.e.  $\bar{X}'$  and  $\bar{Y}'$ , by using the *Eq.1*, it is possible to define the lower bounding approximation of the Euclidean distance between the observed sequences by the following equation:

$$D(\bar{Y}', \bar{X}') \equiv \sqrt{\frac{n}{k}} \sqrt{\sum_{j=1}^k (y'_j - x'_j)^2}. \quad (3)$$

Therefore, the distance measure that refers to the *PAA* approximation can be defined as the square root of the sum of the squared differences between each pair of corresponding *PAA* coefficients, multiplied by the square root of the compression ratio. *Figure 8(B)* illustrates the idea that underlies this measure.

**DIMENSIONALITY REDUCTION OF TIME SERIES DATA BASED ON SAX REPRESENTATION**

If the *PAA* coefficients are then transformed into the symbolic representations,  $\hat{Y}'$  and  $\hat{X}'$ , it is possible to define the *MINDIST* function that returns the minimum distance between two words according to the following expression, (Lin et al. 2003):

$$MINDIST(\hat{Y}', \hat{X}') \equiv \sqrt{\frac{n}{k}} \sqrt{\sum_{j=1}^k \left( dist \left( \hat{y}'_j, \hat{x}'_j \right) \right)^2} . \tag{4}$$

In *Figure 8(C)*, the distance between two *SAX* words is presented. In addition, the distance between two *SAX* representations of time series requires looking up the distances between each pair of symbols, squaring them, summing them, calculating the square root from that sum, and finally multiplying that value with the square root of the compression ratio. The distance between the two *PAA* coefficients has been replaced with the *sub-function* *dist* ( ). For the determination of the *dist* ( ), and the calculation of the *MINDIST* function, an appropriate *lookup table* is used. The value in *cell* ( *r*, *c* ), for any lookup table, according to the size of an alphabet, can be determined using the following equation (Lin et al. 2003):

$$cell_{r,c} = \begin{cases} 0, & \text{if } |r-c| \leq 1 \\ \beta^{\max(r,c)-1} - \beta^{\min(r,c)}, & \text{otherwise} \end{cases} . \tag{5}$$

In *Table 3*, distances between the symbols for the alphabet sizes  $\alpha=3$  and  $\alpha=4$  are presented, respectively. The distance between two particular symbols is determined by matching the corresponding row and column, and reading the value at their intersection, where rows refer to the symbols of one, and columns to the symbols of another time series. For example,  $dist(a, b) = 0$ , and  $dist(c, a) = 0,86$ , for  $\alpha = 3$ , and for an alphabet size,  $\alpha = 4$ ,  $dist(a, b) = 0$ , and  $dist(c, a) = 0,67$ .

**Table 3: A lookup tables for the MINDIST function, for  $\alpha=3$  (left) and  $\alpha=4$  (right)**

<i>Symbols</i>	<b>a</b>	<b>b</b>	<b>c</b>
<b>a</b>	0	0	0.86
<b>b</b>	0	0	0
<b>c</b>	0.86	0	0

<i>Symbols</i>	<b>a</b>	<b>b</b>	<b>c</b>	<b>d</b>
<b>a</b>	0	0	0.67	1.34
<b>b</b>	0	0	0	0.67
<b>c</b>	0.67	0	0	0
<b>d</b>	1.34	0.67	0	0

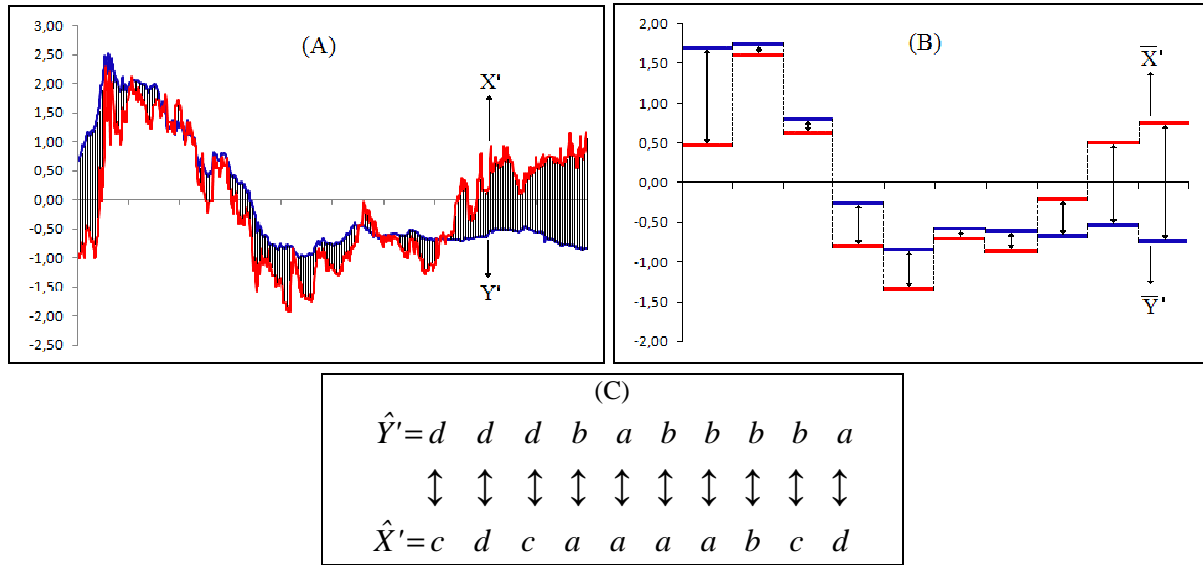

**Figure 8: Visualization of stages in determination of the distance measure between two SAX representations of time series**

[(A): Euclidean distance between the observed two time series, of equal length,  $n=1260$ ; (B): Distance between the two corresponding PAA representations, with the number of segments  $k=10$ , and the compression ratio = 0,0079; and (C): Distance between the two SAX representations, i.e. two SAX words, for  $\alpha=4$ ]

From the above stated follows that *MINDIST function* lower-bounds the Euclidean distance in two stages. In the first stage, according to the steps in construction of *SAX* representation, the *PAA* distance lower-bounds the Euclidean distance (a proof of this statement is presented in Keogh et al. 2000; and Yi and Faloutsos, 2000). In the second stage, *MINDIST function* lower-bounds the *PAA* distance, and therefore, according to the similarity measures property of transitivity, *MINDIST* lower-bounds the true Euclidean distance (a proof of this statement is presented in Lin et al. 2007). Formal confirmation of the listed relations, for these two observed time series, is presented in *Table 4*.

**Table 4: Distance measures**

Distance measures	$D(Y', X')$	$D(\bar{Y}', \bar{X}')$	$MINDIST(\hat{Y}', \hat{X}')$
Calculated distance values	28,95	26,63	15,04

**Conclusion**

Starting from the fact that time series are dominant form of data, present in all areas, and considering the importance of concise approximation forms for the discovery of hidden information in their structure, in this Paper, the essential determinations of *SAX* method, as one relatively recently proposed discretization method for the reduction of dimensionality of time series, are demonstrated. The application of this method is based on the characteristics of normal distribution and discretization of a standardized time series.

Therefore, in the Paper, two time series consisting of 1260 data are transformed into the SAX words with 10 characters, for alphabet size  $\alpha=4$ . After the symbolic transformation was carried out, the comparison of the two SAX representations, by determining the similarity measure (i.e. *distance measure*) called *MINDIST*, was conducted. It has also been emphasized that one of the most important characteristics and advantages of the SAX is that it provides a lower-bounding distance measure.

In view of considerations presented in this Paper, future directions of research efforts, focused on demonstrating the usefulness and empirical validation of SAX representation in the implementation of various data mining tasks, are defined. Future analysis will include the comparison of SAX's performance with the performances and results of other well known time series representations that can be used for solving classic and specific data mining problems.

### **References**

- Agrawal, R. et al. (1993). Efficient similarity search in sequence databases. In: *Proceedings of the 4<sup>th</sup> International Conference on Foundations of Data Organization and Algorithms*, 69–84.
- Berndt, D. and J. Clifford (1994). Using dynamic time warping to find patterns in time series. In: *Proceedings of AAAI-94 Workshop on Knowledge Discovery in Databases*, 229–248.
- Chiu, B. et al. (2003). Probabilistic discovery of time series motifs. In: *Proceedings of the 9<sup>th</sup> ACM SIGKDD International Conference on Knowledge Discovery and Data Mining*, 493–498.
- Chundi, P. and D. Rosenkrantz (2009). Segmentation of Time Series Data. In: *Encyclopedia of Data Warehousing and Mining*, (J. Wang, Ed.), New York, USA: Information Science Reference, 1753–1758.
- Daw, C. S. et al. (2003). A review of symbolic analysis of experimental data. *Review of Scientific Instruments*, 74, 2, 915–930.
- Gunopoulos, D. and G. Das (2000). Time Series Similarity Measures. In: *Tutorial notes ACM SIGKDD 2000*, 243–307.
- Keogh, E. (2010). Data Mining Time Series Data. In: *International Encyclopedia of Statistical Science* (M. Lovrić, Ed.), New York, USA: Springer, 339–342.
- Keogh, E. et al. (2000). Dimensionality reduction for fast similarity search in large time series databases. *Journal of Knowledge and Information Systems*, 3, 263–286.
- Keogh, E. and S. Kasetty (2002). On the need for time series data mining benchmarks: A survey and empirical demonstration. In: *Proceedings of the 8<sup>th</sup> ACM SIGKDD International Conference on Knowledge Discovery and Data Mining (KDD'02)*. ACM Press, 102–111.
- Lin, J. et al. (2003). A symbolic representation of time series, with implications for streaming algorithms. In: *Proceedings of the 8th ACM SIGMOD Workshop on Research Issues in Data Mining and Knowledge Discovery*, 2–11.
- Lin, J. et al. (2005). Visualizing and Discovering Non-Trivial Patterns in Large Time Series Databases. *Information Visualization Journal*, 4, 2, 61–82.
- Lin, J. et al. (2007). Experiencing SAX: a Novel Symbolic Representation of Time Series. *Data Mining and Knowledge Discovery*, 2, 107–144.
- Mörchen, F. (2006). *Time Series Knowledge Mining*. Ph.D. Dissertation, Philipps-University Marburg, Germany. Retrieved from: <http://www.mybytes.de/papers/moerchen06tskm.pdf>
- Ratanamahatana, C. et al. (2005a). Mining Time Series Data. In: *Data Mining and Knowledge Discovery Handbook*, New York: Springer, 1069–1103.
- Ratanamahatana, C. et al. (2005b). A novel bit level time series representation with implications for similarity search and clustering. In: *Proceedings of the 9<sup>th</sup> Pacific-Asia conference on advances in knowledge discovery and data mining*, 771–777.
- Reinert, G. et al. (2000). Probabilistic and Statistical Properties of Words: An Overview. *Journal of Computational. Biology*, 7, 1–46.

- Salomon, D. and G. Motta (2010). *Handbook of Data Compression, Fifth Edition*. NY: Springer.
- Sant' Anna, A. and N. Wickström (2011). Symbolization of time-series: An evaluation of SAX, Persist, and ACA. In: *Proceedings of the IEEE 4<sup>th</sup> International Congress on Image and Signal Processing*, 2223–2228.
- Vlachos, M. et al. (2002). Discovering Similar Multidimensional Trajectories. In: *Proceedings of the 18<sup>th</sup> International Conference on Data Engineering*, 673–684.
- Yi, B. K. and C. Faloutsos (2000). Fast Time Sequence Indexing for Arbitrary  $L_p$  Norms. *Proceedings of the 26<sup>st</sup> International Conference on Very Large Databases*, 385–394.
- Zezula, P. et al. (2006). *Similarity Search – The Metric Space Approach*. New York: Springer.
- Belgrade Stock Exchange, [www.belex.rs], (date of visit: August 2012).





# IT SERVICE MANAGEMENT USING HP ITSM REFERENCE MODEL

Milica Stanković<sup>1</sup>

Danijela Glušac<sup>2</sup>

Jelena Vojinović<sup>3</sup>

**Abstract:** *The development of contemporary IT has a significant effect on business of companies. Therefore IT systems should be treated as an important business resource. In order to provide business success, it is of great importance to transform IT organizations into service providers. Considering the increasing importance of IT services, it is necessary to devote attention to ITSM (Information Tehnology Service Management). The paper will indicate the possibility of improvement IT sector using the model of ITIL (Information Technology Infrastructure Library) processes, based on standard ISO/IEC 20000. Since there are numerous software applications based on ITSM and ITIL, we will focus on Hewlett- Packard's ITSM Reference Model. Based on ITIL best practices and HP experience, the HP ITSM Reference Model is fully integrated IT process relationship map.*

**Keywords:** *ITSM, ITIL, HP ITSM Reference Model, IT services, ISO/IEC 20000*

## Introduction

In today's modern world the significance of using computer technologies and the Internet in order to improve the management of companies is emphasized. Today it is impossible to imagine a company operating without the latest information and communication technologies. The development of IT has had a great impact on the business market of the modern world. With the appearance of more powerful hardware, software and ultra fast networks, organizations have been able to develop their products and services based on IT and to transport them to their markets much faster. These events marked the transition from the industrial age to the age of information. In the information age, everything becomes interconnected and everything functions faster and in a more dynamic way. Globalization has a great influence on the way modern companies work. Since a greater number of companies are becoming globally connected, it is necessary to redefine the basic framework of overall management. IT has become one of the most important resources of modern companies which aids their continuous transformation, in order for them to achieve a competitive market advantage (Sahai and Graupner, 2005). The role of IT has changed drastically over the past years and organizations can expect even more significant changes in the next couple of years. This is because business expectations have changed, and business leaders emphasize that IT will provide the technological solutions which support top business goals such as: the improvement of business processes, cost reductions for companies, a greater usage of information, improvement of labor efficiency, attracting new and keeping old clients, creating innovative products and services (Knapp, 2010).

---

<sup>1</sup> Faculty of Economics, University of Niš, milica.stankovic.vps@gmail.com

<sup>2</sup> Faculty of Law, University of Novi Sad

<sup>3</sup> Faculty of Economics, University of Novi Sad

### IT service management (ITSM) and ITSM forum

Traditionally, IT has meant delivering products: hardware, software, computers, etc. Today IT is typically considered a service domain, even though it uses products for providing IT services. Because of this it is necessary to point out some of the differences between IT products and IT services. In order to better understand these differences, we shall point out some of the basic characteristics of services: services are intangible, are produced and consumed at the same time, they are variable (changeable), the users often influence the quality of the service, the satisfaction with the service is subjective. „Service“ is the basic entity of ITSM. An IT service is a service provided for one or more users by an IT provider. An IT service is based on the use of information technology and provides support for the user's business processes. ITSM is a service-focused approach which was originally known as information technology management (IT management). The basic goal of the ITSM process is to better the quality of IT services. ITSM is related to the management of the quality of IT services which satisfy the needs of businesses (Van Bon et al. 2007). ITSM is related to the management of providing IT services which satisfy the expectations of users. The goal is to constantly improve the quality of services provided, in order to provide effective and efficient management, in coordination with the demands of business. ITSM is becoming more important in the modern world, since there is more reliance on IT when starting a new business (Dubey, 2011). Many companies rely on IT today. This means that the majority of business processes and the very existence of the firm depend on the normal functioning of different IT services. In other words, the focus of most business activities is on services and service management. The successful deliverance of services is a result of good organizational skills and the synergy of the following elements: people, processes, technology, organization and integration (IT Services Management Portal).

- People – This element encompasses the amount and quality of expertise and knowledge.
- Processes – Processes refer to IT and organizational specific practices, procedures, manuals and the degree of their complexity and sophistication.
- Technology – Technology refers to the total technological infrastructure which consists of hardware, software, communication networks, applications, DBMS, etc.
- Organization – This element encompasses the internal and external factors of business which influence IT, the corporate culture of the organization and the way in which these factors influence IT.
- Integration – Integration refers to the way in which IT is integrated into the framework of the business model, the services which IT provides, how the services are provided, which are the best practices employed in IT.

In time, the function of IT management has changed. At the very beginning of IT application, IT management had to provide the necessary IT resources and control the technical harmonization and functionality. In time, IT influenced all segments of business. Today the basic role of IT is the role of service provider, which has led to the development of IT Service Management or ITSM, with IT Infrastructure Management as its key component. The focus of ITSM is on the identification of services which clients find necessary, the planning and delivering of these services, providing availability, performance and security requests. It should be emphasized that IT services have become the center of IT Management and that the basic goal of ITSM is to fulfill the needs of users by providing adequate services. ITSM codifies and supports the best current practices in managing the existing IT infrastructures (Chess et al. 2008). In the future most organizations will adopt ITSM, having in mind the number of advantages of ITSM. These advantages mainly refer to the fact that IT services are coordinated with the needs of users, while the costs of providing IT services are significantly lowered. Organizations depend more and more on IT in order to fulfill their corporate

goals. This growing dependence has led to a growth in the need for IT services which corresponds in quality to the goals of business and which fulfill the demands and expectations of customers. The effectiveness and efficiency of ITSM systems, processes and strategies are of key importance for the success of IT. ITSM is the management of all processes which provide quality IT services, in accordance with the needs of users (Van Bon et al. 2008).

The ITSM Forum is a global, internationally recognized, independent and non-profit organization dedicated to ITSM. The ITSM Forum is owned and managed by all its members. The ITSM Forum was first formed in Great Britain in 1991, but has by today spread to many other countries. The non-profit ITSM Forum brings together companies and government departments around the joint idea of improving their business practices. The ITSM Forum is present in over 50 countries. Its members are many small, big and international companies from different industrial sectors. The ITSM Forum offers possibilities for networking, exchange of experiences and best practices with ITSM experts from around the world (Van Bon and Van der Veen, 2007).

### **IT infrastructure library (ITIL) and ISO/ IEC 20000**

The continual development of information technologies has a great impact on changes in IT organizations. Companies must constantly improve the quality of their services and reduce costs. This makes the existence of IT support necessary in the continual process of business changes. Today a great number of organizations rely on IT in their business to fulfill the expectations of users in regard to the quality of IT services (ITIL: The Basics). The primary goal of service management is to ensure that the IT service is in accordance with the business needs (An Introductory Overview of ITIL V3). Adopting a good practice can help the provider of services create an effective system of service management. Good practice simply means that things that have been proven to be good and efficient are done. Good practice can come from different sources, including public frameworks (such as ITIL, COBIT and CMMI), standards (such as ISO/IEC 20000 and ISO 9000) and the concrete knowledge of people and organizations. ITIL is a public framework which describes the best practice in IT service management. A few frameworks describe the best practices which IT organizations can implement and continually use to improve their ITSM. Many organizations have adopted and adapted best practices from different frameworks in an attempt to develop a cluster of processes which would meet their needs. The most often used ITSM frameworks are: Information Technology Infrastructure Library ITIL, Control Objectives for Information and Related Technology COBIT and Microsoft Operations Framework MOF (Knapp, 2010).

ITIL is a collection of books which describes best practices (Scarborough, 2010). ITIL is widely accepted as the set of best practices from both the private and public sectors all around the world, which describes a systematic and professional approach to managing IT resources. ITIL was developed, documented and published by the UK Office of Government Commerce (OGC). ITIL has now become the de facto standard in providing IT services for all types of organizations (Thejendra, 2008). ITIL has evolved into ITIL V3 which was published in June 2007. ITIL Version 3 helps IT service providers to stay competitive and efficient in providing value for their users. Organizations depend in a large extent on digital information in managing and running their business. From its formation, ITIL has grown and developed in order to meet the challenges faced by ITSM (ITIL is ITIL). ITSM and ITIL on which it is based are integrated, process-based sets of best practices for managing IT services. While ITIL defines and documents best practices, ITSM uses them to meet unique demands and priorities of users (IT Services Management Portal). ITIL gives a comprehensive and consistent collection of best practices for ITSM, promotes the approach to achieving business effectiveness and efficiency by using information systems (Sahai and Graupner, 2005). Above all else, ITIL provides guidelines for international best practices in ITSM (Best Management Practice for IT Service Management).

Until recently ITIL was largely favored by big companies. However, in today's modern world more and more small and medium businesses apply ITIL solutions in their business (Stoller, 2005). Many world-famous companies like IBM, Shell Oil, Procter and Gamble, HP, DHL and many others have adopted ITIL best practices and incorporated them into their business strategy. ITSM deals with the delivery and support of IT services which correspond to the business demands of an organization. ITIL gives a comprehensive, consistent and coherent collection of best practices for ITSM processes. In other words, ITIL defines and documents best practices, while ITSM uses them to fulfill user's needs in regard to the services which users demand. ITIL is not a standard in the formal meaning of the term, it is a framework which is a source of good practices in service management. The goal of the ITIL framework of service management is to provide guidelines applicable to all types of organizations which provide IT services to companies. Solutions based on ITIL have been successfully applied all over the world for a great number of years (Brewster et al. 2010).

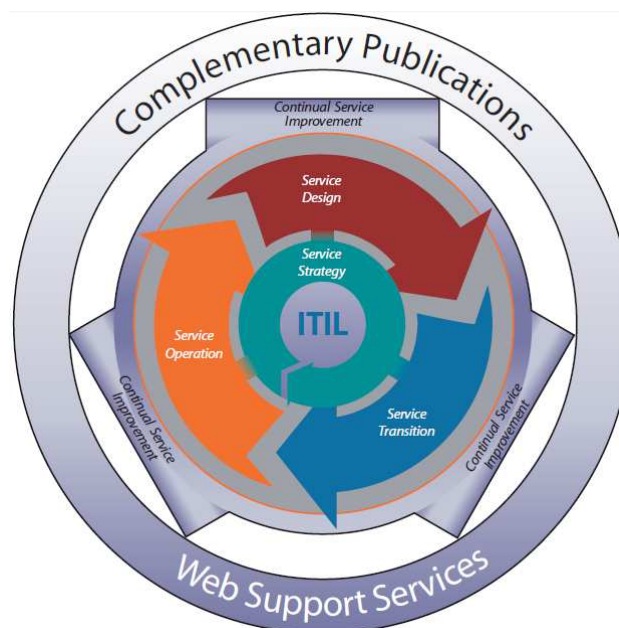

**Figure 1: IT Service Lifecycle**

*(Source: Best Management Practice for IT Service Management)*

Organizations can gain a great number of advantages by using the ITSM frameworks such as ITIL. Some of the advantages are: improvement in the quality of IT services, increase in the satisfaction of final users with the service, a better understanding of IT, reduction of costs, greater accessibility of services which directly results in the increase of business profit and income, financial savings, improvement in decision-making and optimization of risks, improvement in productivity, improvement in the use of skills and experiences, improvement in the delivery of IT services (Official ITIL Website). When we talk about ITIL as a framework of best practices, it is necessary to mention the life cycle of service. The Service Lifecycle entails (ITIL V3 and BiSL):

- Service Strategy – Determines requests and determines which IT services need to be provided.
- Service Design – Refers to designing, creating or changing services and processes of service management in order to fulfill business requests.

- Service Transition – Its goal is to bridge the gap between projects and operations more effectively.
- Service Operations – Entails service providing and an efficient and effective support to services.
- Continual Service Improvement – Refers to the continual monitoring and fulfilling of further needs of clients.

The first ISO standard which refers to IT service organizations was published in 2005: ISO/IEC 20000. This standard was based on a previously published British standard BS 15000. ISO/IEC 20000 is the international standard for ITSM which was developed based on the ITIL process. ISO/IEC 20000 is the first international standard for ITSM which defines ITSM in the following way: ITSM is an integrated process approach which enables IT organizations to provide services which fulfill business requests and needs of users (Van Bon et al. 2007). The ISO/IEC 20000 standard does not evaluate the quality of the products and services of an organization, only confirms that the organization has efficient ITSM processes.

### **Hewlett-Packard's ITSM reference model**

A large number of IT service providers is faced with the necessity of redirecting their focus from managing infrastructure to managing services. ITIL is a coherent and consistent collection of the best ITSM practices, which promotes an approach whose goal is to achieve business efficiency and effectiveness by using information systems. Hewlett-Packard has been providing support to ITIL since 1995. HP's consultants from around the world have gathered to discuss the creation of an ITSM Reference Model. The result of their discussions and agreements is a model which combines the best of what ITIL can offer with the best experiences from the economy. The Hewlett-Packard team has designed a model which points out the need for IT to be viewed not “within a business”, but “as a business.” HP was the first big corporate sponsor of the ITSM Forum in the USA. A large number of this company's employees are active members of the ITSMF around the world (HP and the IT Infrastructure Library ITIL). HP's ITSM solutions are designed in a way which helps organizations use their IT resources more efficiently by integrating people, processes and technology. These solutions help IT organizations provide consistent and reliable services to their customers with foreseeable costs. The HP ITSM Reference Model, based on the industry's best practices, can be used to define and evaluate the current IT environment.

HP's ITSM Reference Model is built on Hewlett-Packard's experience in service management, on ITIL and other best practices. This model is of special importance, since it gives directions to users on how to refocus their efforts to managing services instead of managing technology. Special care needs to be given the key elements necessary for providing services and managing quality IT solutions. In other words, in order for HP's ITSM Reference Model to function efficiently, the integration of three elements is necessary: of processes, people and technology. Hewlett-Packard uses ITIL and HP's ITSM Reference Model in order to help users achieve a maximal IT operating efficiency. HP is of crucial importance to the field of IT Service Management. A large number of organizations and companies has chosen to become a user or partner of Hewlett-Packard. In its basic form, ITSM represents the link between IT and business goals. HP's ITSM Reference Model can help a company to achieve a much greater business value from IT investments, through the implementation of processes for the delivery and support of IT services which are of crucial importance for the company. By focusing on the improvement of IT efficiency, the company can deliver the right information, to the right people, in the right time. The advantages which a company can achieve by implementing the HP model are the following: reduction of operating costs, reduction of business nuisances, increase in the efficiency between IT departments, improvement in the use of available

work force, monitoring of business changes (HP and the IT Infrastructure Library ITIL). Hewlett-Packard is a big IT company with around 150.000 users and a large number of services which need to be managed, and ITIL is a great way to improve service management. ITIL was of crucial importance in the reduction of HP's data centers around the world, from 83 to 6 centers. A large number of Hewlett-Packard's services are based on ITIL principles. By implementing ITIL, Hewlett-Packard has ensured that people in completely different departments can coordinate their activities. One of the great advantages which is ensured by using ITIL refers to eliminating the doubling of data and processes. The key for the right implementation of ITIL are the employees. If the employees of an organization do not support the implementation of ITIL as a best practice, it is not possible to achieve the named advantages (Atkinson, 2007).

Hewlett-Packard provides different technological solutions to users, companies and institutions around the world. The company offers IT infrastructure, global services, business and personal computers. The HP ITSM Reference Model is a significant tool which has proven to be useful in describing many processes in IT management. The HP ITSM Reference Model functions as an integrated IT relationship process map. It has been shown that this model is invaluable to companies around the world which seek possible solutions for their business problems. The model is extremely useful in starting dialogues between all interested parties and providing the most efficient solutions by establishing a common language. Many ITIL terms and definitions are used in HP's ITSM Reference Model, while some were changed and adjusted to the experiences and perspective of Hewlett-Packard. This provides for a better organizational communication by adopting a common vocabulary of terms and definitions and concepts which are used worldwide. It should be remembered that the HP ITSM Reference Model can be applied to any IT company, regardless of its size and whether or not it supports e-business. Hewlett-Packard also uses this model internally, as a means for communication between sectors and the development of its products and services. The HP Service Management Framework is one which incorporates the main ITSM frameworks and standards including ITIL, ISO/IEC 20000 and combines them with the HP Service Reference Model (Knapp, 2010).

The ITSM Reference Model continues to develop based on real experiences around the world. Recently, having in mind the revolution of e-services which is present at the moment, Hewlett-Packard has updated the ITSM Reference Model. The consultants of this company realized in time that a coherent IT model is necessary, one that should help the implementation of IT best practice processes. As a leader in IT infrastructure management, HP Consulting has more than 160 experienced consultants which apply ITIL best practices and enable the transformation of business and the adaptation to the modern needs of users. HP Consulting can help companies design and implement IT processes which reduce the complexity of IT management and coordinate IT services with business needs. Since 1996 HP consulting is an experienced provider of consulting services and products based on ITIL. With over 120 educational centers worldwide, HP provides training for thousands of people employed in the field of ITSM. Based on an integrated principle of learning, the HP ITSM course uses a combination of classic courses and online courses to achieve maximal efficiency and flexibility of studying. Hewlett-Packard has helped hundreds of companies adopt ITSM in a fast and efficient way. HP's outsourcing services have helped companies better their productivity, reduce their costs and improve the quality of their services. HP's SP Certification is in accordance with the BS 15000 standard.

HP's Software Universe includes: HP OpenView Dashboard 1.0, HP OpenView Business Process Insight 2.0, Extended HP OpenView Service Desk Integration, HP OpenView Short Engagement Services (HP and the IT Infrastructure Library ITIL).

- HP OpenView Dashboard 1.0 incorporates information from multiple data sources to provide users with a consolidated and immediate view of the business services that enterprises depend on, such as financial services or telecom applications. HP OpenView Dashboard also links with

HP OpenView Service Desk for an automated IT response to business information related to incidents, changes and service loading.

- HP OpenView Business Process Insight 2.0 software monitors and reports on the health and performance of the IT infrastructure in terms of key business performance indicators in real time. The enhanced software allows service delivery managers to more quickly implement solutions for business process performance and enabling customers to realize a faster return on investment.
- HP OpenView Service Desk 5.0 provides the insight and automated control of the IT systems that comprise a business service. HP OpenView is a basic technology platform for the HP's operating centers worldwide. HP OpenView Service Desk helps in total control and acceleration of business processes, services and infrastructure for all departments of the organization in providing IT services.
- The new HP OpenView Short Engagement Services are on-site consulting services that help customers to evaluate and rapidly implement HP OpenView solutions and third-party products for improved operations.

The HP ITSM Reference Model functions as a fully integrated IT relations process map which shows IT processes and defines IT process requests and solutions. The model is flexible and applicable in any organization. Service management, as the main part of the HP ITSM Reference Model, should be accepted as a business-based approach which IT organization can use to design, build, manage and improve the quality of their IT services. Every key component of HP's ITSM Reference Model includes a set of activities which are necessary for providing the user with effective, reliable and flexible IT services. The key components of the HP ITSM Reference Model are: Business - IT Alignment, Service Design and Management, Service Development and Deployment, Service Operations, Service Delivery Assurance (The HP IT Service Management Reference Model).

- Business - IT Alignment – This component contains the strategic processes which connect an IT strategy with business goals and define a portfolio of services in order to increase business value. The processes found in this group are focused on starting IT „as a business“. These processes are strategic in nature. The parts of this component are: IT Business Assessment, IT Strategy and Architecture Planning, Customer Management and Service Planning.
- Service Design and Management – The processes within this component provide detailed specifications of services in order to achieve a balance between the availability and quality of services and their cost. This component includes activities that refer to defining, creating, negotiating and achieving an agreement about the level of services which satisfy the needs of users. The processes in this group enable IT to translate an IT strategy into planned services by using the detailed specifications of a design. This component includes: Security Management, Continuity Management, Availability Management, Capacity Management and Financial Management.
- Service Development and Deployment – This component includes processes which enable the updating of existing and the development of new services. Once services have been successfully tested, they are integrated into the production environment in order to pass another round of testing, with the aim to reduce the risks tied with this service and to minimize the costs of implementation. There are two parts of this component: Service Build and Test and Release to Production.
- Service Operations – The Service Operations component is the most important part of the HP ITSM Reference Model. The processes in this group function together in order to provide necessary control and support in an IT environment. These processes also manage user

## IT SERVICE MANAGEMENT USING HP ITSM REFERENCE MODEL

satisfaction. Focused on providing services, these processes enable the monitoring and maintenance of a company's IT surroundings. This component refers to: Operations Management, Problem Management and Incident and Service Request Management. Operations Management is closely connected to Incident and Service Management, as well as Problem Management and Change and Configuration Management. Problem Management is focused on reducing the number of problems related to providing services. Incident and Service Request Management is closely connected to the Service Desk. It enables the Service Desk to answer the needs of clients and enable availability of services. The main goal of the Service Operations component is to provide an established level of services and to increase the satisfaction of users.

- Service Delivery Assurance – This component is the center of the ITSM Reference Model for several reasons. First, the processes in this group provide the necessary stability demanded by all of the other processes in the model. Without the processes of Service Delivery Assurance, no other IT process in the model could function efficiently. Secondly, the processes encompassed by Service Delivery Assurance are connected with all of the other processes in the model. This is why it is sensible to put this very important group of processes into the center of the model. This component encompasses the following: Service Level Management, Change Management and Configuration Management. All processes which make up other components of the HP ITSM Reference Model are grouped around the Service Delivery Assurance component which is called the „central knot“. Configuration Management controls the entire IT infrastructure. Change Management controls and ensures the application of standard methods and procedures in situations when changes in the production environment are occurring, in order to minimize the negative effects of the given changes on the quality of services. Service Level Management defines, monitors, reports on and controls the level of services which are delivered to users and determines their correspondence with the beforehand defined standards and parameters.

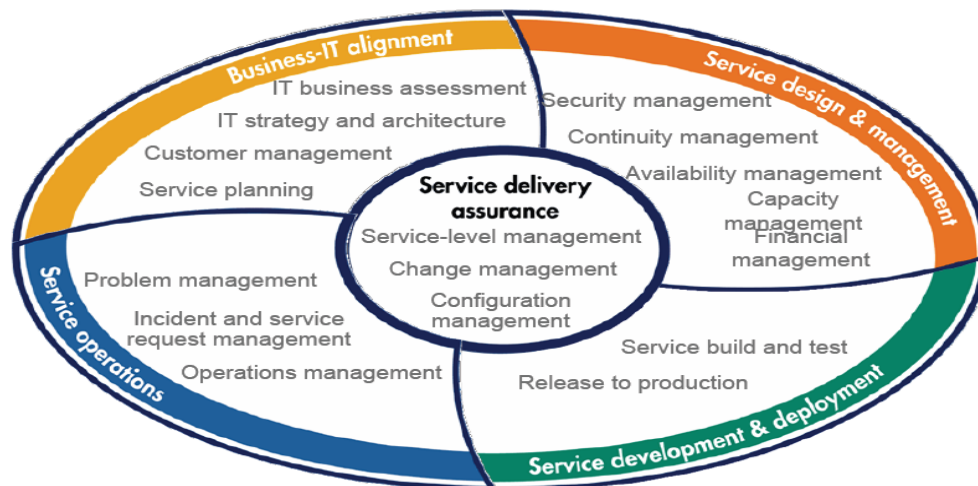

**Figure 2: HP ITSM Reference Model**

(Source: IT transformation using ITIL/ ITSM)

### Conclusion

With the development of modern information technology, organizations depend more and more on IT in order to fulfill their corporate goals. This growing dependence has led to a growing



need for IT services which correspond in quality to the goals of business and which fulfill the demands and expectations of buyers. The effectiveness and efficiency of the ITSM system, processes and strategies are of key importance to the success of IT. ITSM means managing all processes which ensure the quality of an IT service in accordance with the needs of the user. It is necessary to emphasize the importance of the ITSM Forum as a global, international, independent and non-profit organization which refers to ITSM. Today a large number of organizations rely on IT in their business to fulfill the expectations of users in regard to the quality of their IT services. Adopting a good practice can help the provider of services create an effective system of service management. Good practice entails that things that have been proven to be good and efficient are done. Good practice can be created from different sources, including public frameworks (such as ITIL, COBIT and CMMI), standards (such as ISO/IEC 20000 and ISO 9000) or the concrete knowledge of people and organizations. ITIL is a public framework which describes a best practice in IT service management. ISO/IEC 20000 is an international ITSM standard which was developed based on the ITIL process. The Hewlett-Packard Company is a leading global provider of computing, Internet and intranet solutions, services, communications products and measurement solutions, all of which are recognized for excellence in quality and support. HP's development team has created the ITSM Reference Model which is based on ITIL best practices. ITIL best practices can be applied by a great number of companies. The experience of Hewlett-Packard's consultants is added to this model, experience which has been gathered by their efforts to develop and implement service management solutions. This way, by applying the HP ITSM Reference Model, a number of advantages are ensured both to the company and the environment in which it operates.

## References

- Brewster, E. et al. (2010). *IT Service Management*. United Kingdom: British Informatics Society Limited.
- Dubey, S. (2011). *IT Strategy and Management*. New Delhi: PHI Learning Private Limited.
- Knapp, D. (2010). *The ITSM Process Design Guide: Developing, Reengineering, and Improving IT Service Management*. U.S.A.: J. Ross Publishing.
- Sahai, A. and Graupner, S. (2005). *Web Service in the Enterprise: Concepts, Standards, Solutions, and Management*. New York: Springer Science+Business Media.
- Scarborough, M. (2010). *The IT Service Management Foundation*. Dallas: Resulta Publishing.
- Thejendra, B. S. (2008). *Practical IT Service Management*. United Kingdom: IT Governance Publishing.
- Van Bon, J. et al. (2007). *IT Service Management- An Introduction*. Zaltbommel: Van Haren Publishing.
- Van Bon, J. et al. (2008). *IT Service Management- Global Best Practice*. Zaltbommel: Van Haren Publishing.
- Van Bon, J. and Van der Veen, A. (2007). *Release and Control for IT Service Management*. Zaltbommel: Van Haren Publishing.
- Atkinson, B. (2007). IT Library lets us all speak the same language; read from the same page. *Manufacturing Business Technology*, Volume 25, Issue 11, p. 47.
- Chess, D. et al. (2008). Prospects for simplifying ITSM-based management through self-managing resources. *IBM Systems Journal*, Volume 46, Issue 3, pp. 599-608.
- Stoller, J. (2005). The IT best practices revolution. *CMA Magazine*, Volume 79, Issue 5, pp. 46-47.
- IT transformation using ITIL*. ITSM. (8 June 2012) <<http://www.nascio.org/events/webinars/NASCIO%20ITIL060830.pdf>>.
- An Introductory Overview of ITIL V3*. (8 June 2012) <[http://www.best-management-practice.com/gempdf/itSMF\\_An\\_Introductory\\_Overview\\_of\\_ITIL\\_V3.pdf](http://www.best-management-practice.com/gempdf/itSMF_An_Introductory_Overview_of_ITIL_V3.pdf)>.
- Best Management Practice for IT Service Management*. (8 June 2012) <[http://www.best-management-practice.com/gempdf/ITIL\\_White\\_Paper\\_v1.pdf](http://www.best-management-practice.com/gempdf/ITIL_White_Paper_v1.pdf)>.

## IT SERVICE MANAGEMENT USING HP ITSM REFERENCE MODEL

---

*The HP IT Service Management Reference Model.* (10 June 2012) <[http://archive.bitacenter.com/bitalib/itil&itsm/HP\\_wp\\_v2-1.pdf](http://archive.bitacenter.com/bitalib/itil&itsm/HP_wp_v2-1.pdf)>.

*ITIL: The Basics.* (10 June 2012) <[http://www.best-management-practice.com/gempdf/ITIL\\_The\\_Basics.pdf](http://www.best-management-practice.com/gempdf/ITIL_The_Basics.pdf)>.

*Official ITIL Website.* (10 June 2012) <http://www.itil-officialsite.com>.

*ITIL V3 and BiSL.* (12 June 2012) <[http://www.best-management-practice.com/gempdf/BMP\\_ITIL\\_V3\\_and\\_BiSL\\_Sound\\_Guidance.pdf](http://www.best-management-practice.com/gempdf/BMP_ITIL_V3_and_BiSL_Sound_Guidance.pdf)>.

*IT Services Management Portal.* (12 June 2012) <<http://www.itsm.info>>.

*ITIL is ITIL.* (12 June 2012) <[http://www.best-management-practice.com/gempdf/ITIL\\_is\\_ITIL\\_White\\_Paper\\_Mar12.pdf](http://www.best-management-practice.com/gempdf/ITIL_is_ITIL_White_Paper_Mar12.pdf)>.

*HP and the IT Infrastructure Library ITIL.* (12 June 2012)  
<[http://www.mountainview.ca/Mountainview/downloads/hp\\_itsm\\_reference\\_model\\_3.pdf](http://www.mountainview.ca/Mountainview/downloads/hp_itsm_reference_model_3.pdf)>.

# VALUE AT RISK DYNAMIC PORTFOLIO OPTIMIZATION USING GENETIC ALGORITHM: EQUALLY VERSUS EXPONENTIALLY WEIGHTED HISTORICAL VAR APPROACH

Vladimir Ranković<sup>1</sup>

Mikica Drenovak<sup>2</sup>

Zoran Kalinić<sup>3</sup>

Zora Arsovski<sup>4</sup>

**Abstract:** *In this paper we present dynamic portfolio allocation based on Value at Risk (VaR). VaR is predominantly used measure of risk of extreme quantiles in modern finance. Optimal portfolio allocation in the VaR context is computationally very complex since VaR is not a coherent risk metric while number of local optima increases exponentially with the number of constituent securities. For solving portfolio optimization problem genetic algorithm is employed. We used two different approaches of historical simulation to estimate VaR, equally weighting and exponential weighting of returns.*

**Keywords:** *Genetic algorithm, Portfolio optimization, Value at Risk (VaR)*

## Introduction

Market risk, as defined by Alexander (2008b), is the risk resulting from adverse moves in prices of liquid financial instruments. Portfolio allocation is about choosing the best mix from the opportunity set of securities to achieve maximal level of expected return while minimizing risk. By investing in a portfolio of securities some of the risk of individual securities may be diversified away. The fundamental principle of diversification was formally introduced by Markowitz (1952). The Markowitz problem boils down to the determination of portfolio with minimal possible risk for a given level of return, where risk is measured by variance (standard deviation). Set of solutions of Markowitz problem for different levels of return form so called efficient frontier which represents the optimal trade-off between the risk and return.

When using variance to estimate risk we implicitly assume that returns are normally distributed, i.e. that distribution is fully explained by first two moments, return and standard deviation. However, empirical distributions of returns typically are asymmetric distributions with more events in tails relative to normal distribution suggesting that part of the risk is hidden in the higher moments of distribution. The importance of third moment in portfolio optimization was first suggested by Samuelson (1958) while Markowitz (1959) suggested semivariance for the measure of downside risk.

Nowadays, investors and regulators are mostly concerned about the risk of extreme quantiles. The risk of extreme quantiles is typically measured by value at risk (VaR) and conditional value at risk (CVaR). Although it is not a coherent risk metric (Szego, 2002), VaR is predominantly used risk

---

<sup>1</sup> Faculty of Economics, University of Kragujevac, vladimir.j.rankovic@gmail.com

<sup>2</sup> Faculty of Economics, University of Kragujevac

<sup>3</sup> Faculty of Economics, University of Kragujevac

<sup>4</sup> Faculty of Economics, University of Kragujevac

## VALUE AT RISK DYNAMIC PORTFOLIO OPTIMIZATION USING GENETIC ALGORITHM: EQUALLY VERSUS EXPONENTIALLY WEIGHTED HISTORICAL VAR APPROACH

---

measure of extreme quantiles, in particular upon the introduction of new banking regulations for market risk in 1996 (Basel Committee on Banking Supervision, 1996).

Portfolio VaR can be estimated analytically, as a function of underlying constituents' parameters, only if we assume that its return distribution can be accurately approximated by some theoretical distribution. In Danielsson (2007) authors demonstrated that the number of local optima increases exponentially with the number of securities. Optimal portfolio allocation in the VaR context is therefore computationally very complex.

Depending on applied risk model, portfolio optimization may be highly nonlinear problem, very difficult to solve using deterministic methods. In practice, portfolio optimization problems become even more complex since they include a lot of additional constraints such as: cardinality constraints, transaction cost, trading limitation etc. In order to overcome drawbacks of deterministic methods, several researchers applied metaheuristics (either single or multiobjective) to solve portfolio optimization problems.

Recently, there are various studies applying genetic algorithms for solving portfolio optimization problems based on different risk measures and/or additional constraints. Arnone et al. (1993) applied a GA for solving unconstrained portfolio optimization problem in the context of downside risk measures. Kyong et al. (2005) presented portfolio optimization for index fund management based on genetic algorithm. Lin and Liu (2008) presented study about portfolio optimization with the minimum transaction lots constraint. Proposed solution was also based on application of GA. More recently, Chang et al. (2009) presented heuristic approach to portfolio optimization problems in different risk measures by employing genetic algorithm. As risk measures authors used semi-variance, mean absolute deviation and variance with skewness. Portfolio optimization using VaR as risk measure was presented by Dallagnol et al. (2009). Lin and Ko (2009) used GA to extract the best portfolio set and most suitable peak threshold in order to estimate the portfolio's VaR by means of EVT. Finally, Anagnostopoulos and Mamanis (2011) presented interesting study about effectiveness of five state-of-the-art multiobjective evolutionary algorithms (MOEAs) together with a steady state evolutionary algorithm on the mean–variance cardinality constrained portfolio optimization problem.

In this paper we analyze portfolio optimization based on VaR using two different approaches of historical VaR estimation. In the first approach we use equally weighted historical VaR estimation while exponentially weighted historical VaR estimation is used as an alternative. Using the same set of financial assets we performed dynamic daily portfolio optimization regarding these two approaches for the observed period. As a result two different sequences of daily optimized portfolios are obtained. Portfolio optimization is performed by employing GA. In practice investors should take transaction costs into account while applicable portfolio solution must impose portfolio holdings as integers. For simplicity we assume that there are no transaction costs or taxes while securities are perfectly divisible. Therefore we do not question the merits and feasibility of dynamic daily portfolio optimization. Finally, we analyze these two methodologies by comparing characteristics of VaR estimates over 1-day horizon.

The remainder of this paper is organized as follows. In Section 2 we introduce historical VaR model. In Section 3 portfolio optimization model is defined. The fundamentals of genetic algorithm operators are presented in Section 4. In Section 5 we provide computational results. In section 6 we discuss the results and conclude.

### Value at Risk (VaR) model

VaR can be interpreted as a loss that will be exceeded only in  $\alpha \times 100\%$  of the time, for a given significance level  $\alpha$  and time horizon  $t$ . Mathematically, VaR is defined as  $\alpha$ -quantile of distribution.

Expressed in value terms, VaR is the  $\alpha$ -quantile of profit and loss distribution, while expressed as a percentage of portfolio's value it is the  $\alpha$ -quantile of return distribution.

Formally, for the return  $r_\alpha$  such that  $p(r < r_\alpha) = \alpha$  percentage VaR is defined as:

$$VaR = -r_\alpha \quad (1)$$

where  $\alpha$  is significance level (i.e.  $1-\alpha$  is confidence level) and  $F^{-1}(\alpha)$  denotes  $\alpha$ -quantile of return distribution  $r$ , that is, the inverse of distribution function at  $\alpha$ . Minus sign is needed since VaR is defined as positive value. If the distribution function of returns,  $F(\alpha)$ , is known then  $\alpha$ -quantile is calculated as  $r_\alpha = F^{-1}(\alpha)$ . When empirical distribution of portfolio returns is used VaR is referred to as historical VaR.

Historical VaR does not assume any parametric form of the distribution of risk factor returns (see Pritsker (2006) for more details on historical VaR and its variants). It is rather intuitive and easy to calculate measure at portfolio level. On the other hand, when using historical VaR there is potential risk to underestimate risk of future movements since historical VaR assumes that realized distribution would be repeated in the future. In addition, historical VaR estimates are dependent on sample size and may result in conflicting results for different significance levels. Yet, Perignon and Smith (2006) report that almost 75% of banks prefer to use historical VaR rather than alternative VaR models.

In general, historical VaR cannot be expressed as a function of underlying constituents' parameters. Thus, to perform portfolio optimization in VaR context, calculation of time series of portfolio returns is required. Historical VaR as given by Eq. (1) is often referred to as equally weighted historical VaR as it implies equal importance (probability) for all returns from the sample. Hence, the estimate of historical VaR is equal to minus value of maximum of the subset containing  $\alpha$  percentage of the lowest returns of considered portfolio. For example, for time series consisted of 100 returns, implied probability weight for all returns would be 1/100, and consequently, the 5% historical VaR would be minus value of 5-th lowest return.

Major problem with equal weighting of returns is that the ordering of returns is irrelevant. In other words, extreme events from the sample can impact VaR estimate regardless of their distance in the past.

Historical VaR model can be adapted so that more recent events have more impact on the VaR estimate which is in line with reality. Instead of equal weighting we assign an exponential probability weight to each return. Under this model we choose constant  $\lambda$  between 0 and 1 and then assign the probability  $1-\lambda$  to the most recent observation (return), the weight  $\lambda(1-\lambda)$  to the preceding return and then  $\lambda^2(1-\lambda)$ ,  $\lambda^3(1-\lambda)$ , ..., to the returns preceding further into the past, respectively. The sum of weights limits 1 implying that they can be regarded as probability weights. Then we sum up probability weights assigned to returns when they are sorted in an increasing order. The objective is to obtain cumulative probability which equals regarded significance level of VaR. Then VaR estimate is equal to minus last return which weight was taken in the sum. Figure 1 shows exponential probability weights for three different values of  $\lambda$  and probability weights for equally weighted for time series of 252 observations length.

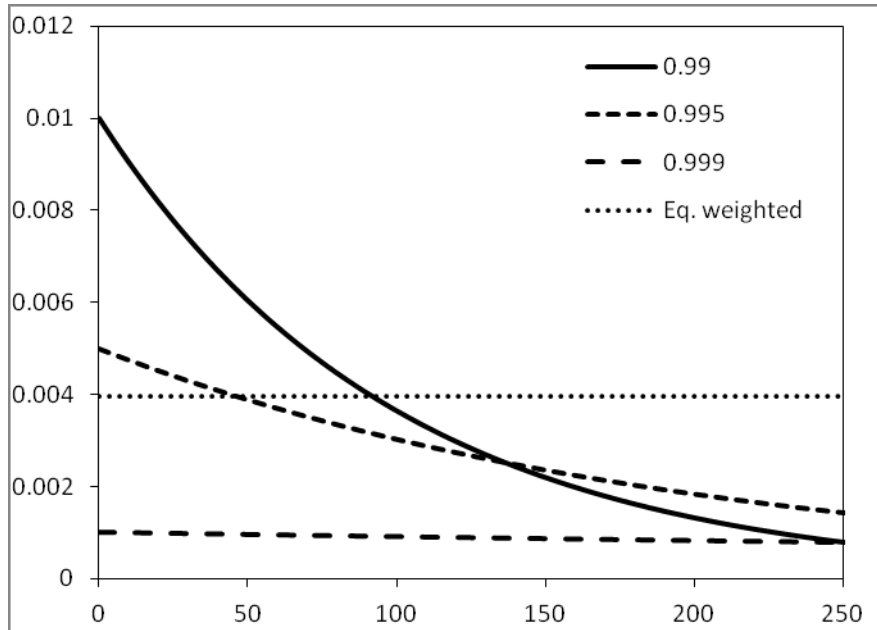

**Fig. 1. Exponential probability weights on returns**

Exponential probability weights impose the largest weight (that is, the largest influence) to the most recent observation. At the same time, the larger the value of  $\lambda$  the lower the weight of the more recent returns and the higher the weight of the returns more distant in the past. The main shortfall of this approach lies in the fact that model is dependent on chosen  $\lambda$ . It should be noted that VaR estimate does not, by rule increase or decrease with  $\lambda$ . It depends on the time distribution of the largest returns.

### Optimization model

Formally, portfolio optimization problem can be defined as follows:

$$\min VaR(\mathbf{w}) = -r_\alpha \quad (2)$$

$$\text{subject to} \quad \sum_{i=1}^N w_i = 1 \quad (3)$$

$$0 \leq w_i \leq 1, \quad i = 1, \dots, N \quad (4)$$

Where  $\mathbf{w}$  denotes vector of portfolio weights  $w_i$  and  $VaR(\mathbf{w})$  denotes value at risk of a portfolio.

Eq.(2) minimizes VaR of the portfolio. Eq. (3) describes the standard budget constraint which requires that portfolio weights must sum up to 1.

Eq. (4) describes the constraint that no short sales are allowed, which means that none of the portfolio weights can be negative.

The model presented above is a standard single-objective optimization problem. The main goal of this optimization problem is to find portfolio (i.e. vector of weights  $w_i$ ) which provides minimal risk in terms of VaR.

### Methodology - Genetic Algorithms

Genetic algorithm is a stochastic optimization technique invented by Holland (1975) based on the Darwin principle that in the nature only “the fittest survive”. The main idea of Holland’s theory is the application of the basic phenomena of the biological evolution such are inheritance, crossover and mutation, in order to find (generate) solution that best fits. In the case of portfolio optimization problems, term “the fittest” corresponds to optimal portfolio.

So, in GA there is a set of individuals often called population. Each individual from population presents candidate solution of optimization problem. The individuals are usually referred to as chromosomes. Each chromosome, i.e. candidate solution, represents decision vector made of decision variables.

In this research, each individual (chromosome) presents one weight vector  $\mathbf{w}$ , that is single candidate portfolio. Further on, each gene corresponds to weight  $w_i$ .

Generally, genetic algorithm consists of the following steps:

1. Initialization of population with random individuals,
2. Fitness evaluation of the individuals in the population,
3. Generation of new population, using crossover and mutation,
4. Selection of individuals according to their fitness using some strategy,
5. Stop if terminating condition is satisfied, otherwise go to step 2.

In the genetic algorithm basic biological phenomena such as selection, crossover and mutation are realized with adequate operators. In the modern literature a number of different evolutionary operators can be found. Choice and application of some certain operator depends on optimization problem which genetic algorithm is applied on. In this research we applied single point crossover, uniform mutation and Roulette wheel selection.

Single point crossover operator involves two parents and produces two offspring (two new individuals). Idea is to divide both parents’ chromosomes in two segments at dividing point (gene) and then to swap obtained segments. Operator is stochastic one, because the dividing point is chosen randomly each time operator is applied.

The uniform mutation operator is implemented as follows. First, a set of randomly chosen individuals that will mutate is generated. For each individual from this set two genes are randomly selected. Then, the value of first gene (weight parameter) is increased by some predefined value (e.g. 0.1) and the value of second gene is decreased by the same value.

In this research for selection operator is chosen and implemented Roulette wheel selection. Roulette wheel selection is partly stochastic strategy and is analogue to casino roulette wheel. Selection process is random but based on fitness value of individuals. So, an individual with better fitness value (in this case smaller risk) has a more chance of being selected and vice versa. Obviously, this strategy does not provide keeping the best individual found during the evolutionary process. In order to overcome this lack, common Roulette wheel operator is improved in term that best individual in each generation is isolated and transferred to the next generation.

The key process in portfolio optimization is fitness evaluation. Although we used two different weighting approaches of empirical portfolio returns, the same fitness evaluation algorithm is applied. In the following we present the basic steps of fitness evaluation algorithm:

1. Generate candidate solution (vector of portfolio weights  $\mathbf{w}$ ).
2. Generate time series of portfolio returns.

## VALUE AT RISK DYNAMIC PORTFOLIO OPTIMIZATION USING GENETIC ALGORITHM: EQUALLY VERSUS EXPONENTIALLY WEIGHTED HISTORICAL VaR APPROACH

---

3. Assign probability weights to portfolio returns (equal or exponential).
4. Sort portfolio returns in increasing order.
5. Sum up assigned probabilities to predefined significance level of VaR starting with the smallest return.
6. Assign minus value of the last return taken in the sum to the VaR of candidate portfolio (fitness value).

### Data and research results

In this section, we present computational results obtained by performing experiments on a historical data set. Calculations are based on daily net asset values of a sample of 10 exchange-traded funds (ETFs): iShares Barclays 7-10, iShares eb.rexx 5.5-10.5, iShares iBoxx € Liquid Sovereigns Capped 5.5-10.5, db x-trackers iBoxx € Sovereigns 5-7, db x-trackers iBoxx € Sovereigns 7-10, Lyxor EuroMTS 5-7, Lyxor EuroMTS 7-10, iShares eb.rexx DE, iShares iBoxx € Liquid Sovereigns Capped 1.5-10.5 and db x-trackers iBoxx € Sovereigns overall. The source of our data is the official websites of sample ETFs' providers.

Underlying indices for sample ETFs are debt portfolios with exposure to euro zone sovereign debt. First 7 ETFs comprise representative sample of debt portfolios which target bonds from 5 to 10 years maturity segment<sup>5</sup> while the latter 3 ETFs target overall bond indices which include different maturity segments.

In times of market turmoil investors typically move towards less risky and more liquid financial products, such is sovereign debt. At the same time, current financial crisis strongly affected euro zone sovereign debt due to increased credit and liquidity risk concerns. Yield spreads rose sharply while correlations dropped. As a consequence, empirical return distributions of sovereign debt portfolios are more often characterized by extreme events. Investing in sovereign debt of euro zone countries through ETFs is arguably the most liquid way of getting desired exposure during the crisis while daily data are publicly available.<sup>6</sup> The motivation for choosing 5-10 maturity segment ETFs for the research is the fact that their return distributions are highly non-normal for chosen sample period (see more on characteristics of euro zone sovereign debt ETFs in Drenovak and Urosevic (2010)).

We used historical daily data for sample ETFs for the period June 2007 to December 2008. We considered 5% 1-day historical percentage VaR of long-only linear portfolios. The research consists of daily dynamic portfolio optimization for the period June 1<sup>st</sup> 2008-November 25<sup>th</sup> 2008 (126 observations in total) with the rolling window of 252 daily observations. Observed period include market events just prior to the outbreak of current financial crisis as well as dramatic market movements after the outbreak (we take default of Lehman Brothers as official beginning of the crisis). We applied equal weighted and, in addition, exponential weighted VaR approach for four different values of  $\lambda$  (0.9, 0.99, 0.995, 0.999). As a result we obtained five different time series of daily optimized portfolios.

For each day in the observed period and each of the approaches we assumed that realized VaR of given optimized portfolio is an VaR estimate over 1-day horizon. Then we compared estimated VaR and return realized on the following day. Fig. 2 shows hit sequences (sequences of violations of VaR) for equally and exponential weighted 1-day 5% historical VaR (sequence for  $\lambda=0.999$  is excluded from the figure for clarity reasons).

---

<sup>5</sup> These are all European ETFs targeting 5-10 year maturity segment of euro zone sovereign debt covering period chosen for this research.

<sup>6</sup> Sovereign debt markets are typically over-the-counter markets where data are not publicly available. In contrast, ETFs are traded on organized exchanges which provide daily time series of data.



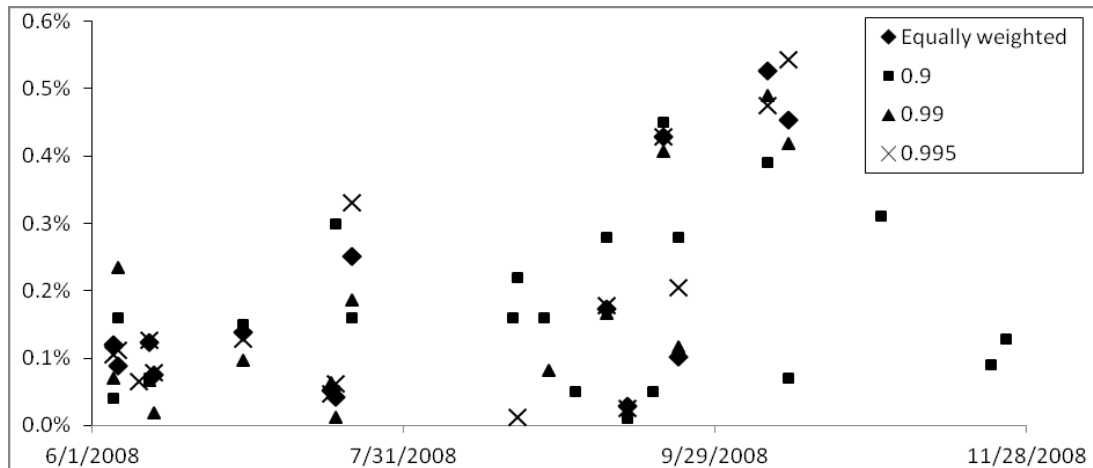

**Fig. 2 Hit sequences for equally and exponential weighted 1-day 5% historical VaR**

Table 1 shows number and average (mean) value of violations from Fig. 2.

**Table 1. Number and average violation of 1-day 5% historical VaR**

	Eq. weighting		Exp. weighting		
$\lambda$	-	0.9	0.99	0.995	0.999
No. of violations	14	20	14	16	31
Average violation	0.186%	0.176%	0.174%	0.183%	0.245%

Theoretically, for 5% VaR we expect approximately 5% of violation relative to an estimate over the observed period and only then we can claim model eligibility.<sup>7</sup> According to presented results, there is significantly larger number of violations than expected (5% of 126 is approximately 7), regardless of chosen approach.

Results suggest that application of exponential weighted VaR did not improve VaR estimation regarding number of violations if compared with equal weighting, regardless of chosen  $\lambda$ . On the other hand, average violation is smaller for 3 out of 4 different  $\lambda$  values if compared with equal weighting.

### Discussion

Current financial crisis revealed the importance of proper estimation of risk of extreme quantiles. As noted, risk of extreme quantiles is predominantly measured by value at risk (VaR). With equally weighted historical VaR, all extreme events have equal impact on VaR estimation regardless of time of their occurrence in the observed period. If applying exponentially weighted VaR we are in position to increase the impact of recent events relative to events that occurred more in the past. In addition, we can control that impact by choosing appropriate  $\lambda$ . Major problem is that there is no

<sup>7</sup> Note that there are several formal backtesting procedures for testing the adequacy of number and distribution of VaR violations existing in the literature. For example see Christoffersen (2003)

## VALUE AT RISK DYNAMIC PORTFOLIO OPTIMIZATION USING GENETIC ALGORITHM: EQUALLY VERSUS EXPONENTIALLY WEIGHTED HISTORICAL VaR APPROACH

---

cooking recipe for choosing appropriate  $\lambda$ . In this paper we compared characteristics of a portfolio which is dynamically optimized regarding equally weighted historical VaR with a portfolio which is dynamically optimized regarding exponentially weighted historical VaR. To test eligibility of an approach we analyzed hit sequence and, also, we compared frequency and scale of VaR violations between the two approaches. Results suggest that neither approach can deliver satisfactory VaR estimation for sample data.

For chosen data sample, with equally weighting, probability weight is  $1/252$ . Applying exponential weighing with  $\lambda=0.9$  impact of the most recent events dramatically increases (e.g. impact of the most recent event is  $1/10$ ). Consequently, impact of more distant events rapidly decreases (model has short memory). At the same time, for  $\lambda=0.9$  sum of all 252 weights is very close to 1 which is consistent with the definition of probability weights.

The higher the value of  $\lambda$  the longer the memory and exponential weighted model is more similar to equally weighted model in terms of “equality of weights” (see Fig. 1). In addition, higher values of  $\lambda$  induce lower weights. However, in our case, that is data sample of 252 observations, for  $\lambda=0.999$  all exponential probability weights become smaller than weight under equal weighting scheme (see Fig. 1). Consequently, when estimating exponentially weighted VaR we need to sum up assigned probabilities for larger number of extreme events which increases probability of VaR underestimation. This explains relatively large number of VaR violations and high average violation for  $\lambda=0.999$  (see Table 1). In this particular case, exponential weights sum up to 0.223 and basic assumption regarding probability weights is not satisfied.

We could not find clear advantage of exponential weighting compared to equal weighting if applied to VaR estimation. Though, it should be emphasized that observed period is characterized by extreme market volatility and several structural breaks in movements of returns of constituent securities.

Next step would be to do some additional research into possibility of applying exponential weighting to time series of data with different longitude and further investigate time distribution of VaR violations.

### Acknowledgements

Research presented in this paper was supported by Serbian Ministry of Science and Technology, Grants III-44010 and OH 179005.

### References

- Alexander (2008a). *Quantitative Methods in Finance* (1th ed.), England: John Wiley & Sons Ltd, (Chapter 1).
- Alexander (2008b). *Value-at-Risk Models* (1th ed.), England: John Wiley & Sons Ltd, (Preface).
- Anagnostopoulos, K.P., and Mamanis, G. (2011). The mean-variance cardinality portfolio optimization problem: An experimental evaluation of five multiobjective evolutionary algorithms. *Expert Systems with Applications*, 38, 14208–14217.
- Arnone, S., Loraschi, A., and Tettamanzi, A. (1993). A genetic approach to portfolio selection. *Neural Network World*, 6, 597–604.

- Basel Committee on Banking Supervision (1996). Amendment to the capital accord to incorporate market risks. <http://www.bis.org>. Last accessed August 2012.
- Chang, T.-J., Yang, S.-C., and Chang, K.-J. (2009). Portfolio optimization problems in different measures using genetic algorithm. *Expert Systems with Applications*, 36, 10529–10537.
- Christoffersen F. P., (2003) *Elements of Financial Risk Management*. Academic Press, Elsevier Science
- Dallagnol, V. A. F., Van den Berg, J., and Mous, L. (2009). Portfolio Management Using Value at Risk: A Comparison between Genetic Algorithms and Particle Swarm Optimization. *International Journal Of Intelligent Systems*, 24, 766–792.
- Danielsson, J., Jorgensen B. Casper G., and Yang X. (2007). Optimal Portfolio Allocation Under the Probabilistic VaR Constraint and Incentives for Financial Innovation <http://www.riskresearch.org/files/BJ-CdV-JD-01-8-11-997520309-11.pdf>. Last accessed August 2012.
- Drenovak, M, and Urosevic, B. (2010). Exchange-traded funds of the Euro zone sovereign debt, *Economic Annals*, 187, 31-60
- Holland, J. H. (1975). *Adaptation in natural and artificial systems: An introductory analysis with applications to biology, control, and artificial intelligence*. University of Michigan Press.
- Kyong, J. O., Tae, Y. K., and Sungky, M. (2005). Using genetic algorithm to support portfolio optimization for index fund management. *Expert Systems with Applications*, 28, 371–379.
- Lin, C. C., and Liu, Y. T. (2008). Genetic algorithms for portfolio selection problems with minimum transaction lots. *European Journal of Operational Research*, 185, 393–404.
- Markowitz, H. M. (1952). Portfolio selection. *Journal of Finance*, 7, 77–91
- Markowitz, H. M. (1959). *Portfolio Selection: efficient diversification of investments*. New York: John Wiley and Sons, (Chapter 9).
- Perignon, C., and Smith, D. (2006). The Level and Quality of Value-at-Risk Disclosure by Commercial Banks Working paper [http://www.unifr.ch/controlling/seminar/2007-2008/Perignon\\_ParisII.pdf](http://www.unifr.ch/controlling/seminar/2007-2008/Perignon_ParisII.pdf), Last accessed August 2012.
- Lin, P. C., and Ko, P.C. (2009). Portfolio value-at-risk forecasting with GA-based extreme value theory, *Expert Systems with Applications*, 36, 2503–2512.
- Pritsker, M. (2006). The hidden dangers of historical simulation. *Journal of Banking and Finance*, 30, 561-582.
- Samuelson, P. (1958). The fundamental approximation theorem of portfolio analysis in terms of means variances and higher moments. *Review of Economic Studies*, 25, 65–86.
- Szego, G. (2002). Measures of risk. *Journal of Banking and Finance*, 26, 1253–1272



# RESAMPLING STATISTICS – BOOTSTRAP

Nataša Pešić Radosavljević<sup>1</sup>

Nenad Tomić<sup>2</sup>

**Abstract:** *The paper provides short insight into resampling methods, accentuating bootstrap method, discusses its history, areas of implementation (with practical examples), advantages and possible disadvantages of the method. Simulation, as basic tools for resampling enable analysis of almost all data, including those that could not be analyzed with standard formulas. The main focus of the paper is estimation of damages that should be covered by insurance companies through resampling tools. Computers contributed to the development of inferential statistics and induced further advancement of bootstrap that became more popular both for professionals and students in statistics, social sciences and medicine.*

**Keywords:** *resampling, bootstrap, asymptotic, hypothesis testing*

## Introduction

Bradley Efron (1938) is American statistician, professor of prestigious University of Stanford, California. His PhD was in statistics at Stanford department for statistics, and continued with scientific research afterwards. He is famous by the proposition of so called resampling technique of bootstrap, which largely impacted over the whole statistical world and statistical applications. Efron has received the highest recognition for his work in the area of statistics, member of American Academy of Sciences, and is one of only two statisticians in USA awarded the National medal for science, highest state award for scientific contribution in the development of bootstrap method.

The term bootstrap in the original translation from English is a loop for boots. The verb to bootstrap in allegorical meaning would be self-help, but in an exaggerated manner, to create more favorable situation than previous one without any help (specially in the example “to pull yourself by the boots’ loops high enough to jump the fence”, accomplishment equal to Baron Munchausen).

Bootstrap is statistical method for estimation of sample distribution of the statistics, through taking new samples with repetition from original sample, most often with the goal to find robust estimation or standard error and confidence interval for parameters of population like mean, median, coefficient of correlation or regression coefficient. Also, it can be used for testing the hypothesis. It is often used as robust alternative for parametric inference, when the hypothesis are brought into question, or cases when parametric inference is not possible or demands very complex formulas for calculating standard errors.

The huge advantage of bootstrap is its simplicity. It is direct in estimation of standard error or confidence intervals for complex estimations of complex distribution parameters, like percentiles, proportions, correlation coefficients. Also, it is very suitable for control and checking the stability of results.

Although bootstrap is asymptotically consistent, it does not provide security like in definite sample. Further, it has the tendency to be over optimistic. Also, obvious simplicity can neglect the fact

---

<sup>1</sup> Faculty of Economics, University of Kragujevac

<sup>2</sup> Faculty of Economics, University of Kragujevac, nelzonuitaliji@live.com

that bootstrap analysis starts from important assumptions (for example, that sample is independent), while in other approaches these samples are more formal.

### Principles of bootstrap

Traditional approach to statistical inference is based on idealized models and assumptions. Expressions for measures of accuracy, like standard error, are based on asymptotic theory and are not suitable for small sample. Modern alternative for traditional approach is bootstrapping method, introduced by Bradley Efron in 1979. Bootstrapping is computer-intensive method of resampling, widely applicable and allows treating more realistic models. First, we would look through basic principles of bootstrap model, and then illustrate basic on one example.

Bootstrap is another method of resampling (English resampling methods), which compensates defects of unknown population. Older and more general method, jackknife, was used as inspiration for creation of bootstrap principles, according to Bradley Efron himself: "My first thoughts on bootstrap were focused on variance and bias estimation. This is totally natural having in mind that bootstrap is derived from jackknife literature, with papers Quenouille (1949) on bias, and Tukey (1958) on variance that defined the agenda. (Fox, 2002)

The paper published by Efron in 1979, introduced new principle useful and functional in many cases. It demonstrated that jackknife is linear approximation of this new model. Bootstrap is simpler than its predecessor, but more conditions must be defined for it. Also, it managed to bring desired results also in those segments where jackknife failed.

Basic idea of bootstrap method is that when information on distribution is missing observed sample contains all available information on observed distribution, and therefore resampling from the sample is the closest that we could get from resampling the population itself. Suppose we take a sample  $S = \{X_1, X_2, \dots, X_n\}$  from population  $P = \{x_1, x_2, \dots, x_N\}$ ; assume further that in this moment  $N$  is much bigger than  $n$ , and that sample is simple random sample, as well as independent, extracted from population  $P$ . Assume that sample  $S = (X_1, X_2, \dots, X_n)^T$  is used for estimation parameter  $\Theta$  of population, and  $T = t(S)$  is statistics that estimates  $\Theta$ . In order to make statistical inference on  $\Theta$ , we are interested in sample distribution  $T$  in order to estimate accuracy of our estimation, or create confidence interval for our estimation of parameter  $\Theta$ . In certain situations, the exact sampling distribution of statistics  $T$  cannot be defined, so instead is derived asymptotic distribution. This approach has two potentially important deficiencies:

1. If the assumption that population has normal distribution is inaccurate, then corresponding distribution of statistics is very wrong. On the other hand, if we are focused on asymptotic results, they might not be precise enough in relatively small samples.
2. The approach demands sufficient mathematical skill to prepare sample distribution of statistics of interest. In some cases, such derivation is too hard. (Efron, 1979)

If the real population  $P$  is known, we could take samples  $X(b)$ ,  $b = 1, \dots, B$ , from  $P$ , and use Monte Carlo method to estimate sample distribution of our estimation  $T$ . Because  $P$  is unknown, and we could derive samples from it again, the idea of bootstrapping suggests resampling from original sample. This distribution, from which are taken bootstrapped samples, is called empirical distribution.

The essence of bootstrap principle is to "create bootstrap world, where the population is related to the sample in the same manner as sample (that is empirically known distribution) to bootstrap sample". Namely, it is created probability sample distribution, marked with  $\hat{P}$ , so that each observation in the sample has  $1/n$  probability to be selected in bootstrapped sample. (Eichler, online available at <http://galton.uchicago.edu/~eichler/stat24600/Handouts/bootstrap.pdf>)

Sampling is done with repetition, which practically means that in each phase of sample selection one element has equal opportunity to be selected in the new (in this case bootstrapped) sample, so that, when we take sample from  $\hat{P}$ , i observation of  $X_i$  in the original sample has the probability of  $1/n$  in all phases of selection.

This is now situation where bootstrap is parting from jackknife. In jackknife new sample is subsample of the main sample, which has  $n-m$  observations (where  $m$  defines how much smaller it would be comparing to main sample and therefore how many sub samples could be derived). In bootstrap the point is that bootstrapped sample is of the same size  $n$  as original sample, and observations could be repeated in bootstrapped sample (which is logical, because in opposite case it would be reproduction of one sample to another). When we complete sampling, we would have bootstrap sample as the result  $S^*_1 = \{X^*_{11}, X^*_{12}, \dots, X^*_{1n}\}$ . The procedure is further repeated,  $B$  times, where it is necessary for  $B$  to be some large number; some  $b$  bootstrapped sample has the form of  $S^*_b = \{X^*_{b1}, X^*_{b2}, \dots, X^*_{bn}\}$ .

Now we will try to understand analogy between real world and bootstrapped world: in real world we have:

- $S = (X_1, \dots, X_n)^T$  is random sample from population  $P$
- $\Theta = t(p)$  is some parameter of population
- $T = t(S)$  is estimation of parameter  $\Theta$

And in bootstrap world exist the following values:

- $S^* = (X^*_1, \dots, X^*_n)^T$  is bootstrap sample from sample  $\hat{P}$
- $\Theta^* = t(\hat{P})$  is some parameter in bootstrap world
- $T^* = t(S^*)$  is estimation of parameter  $\Theta^*$  in bootstrap world

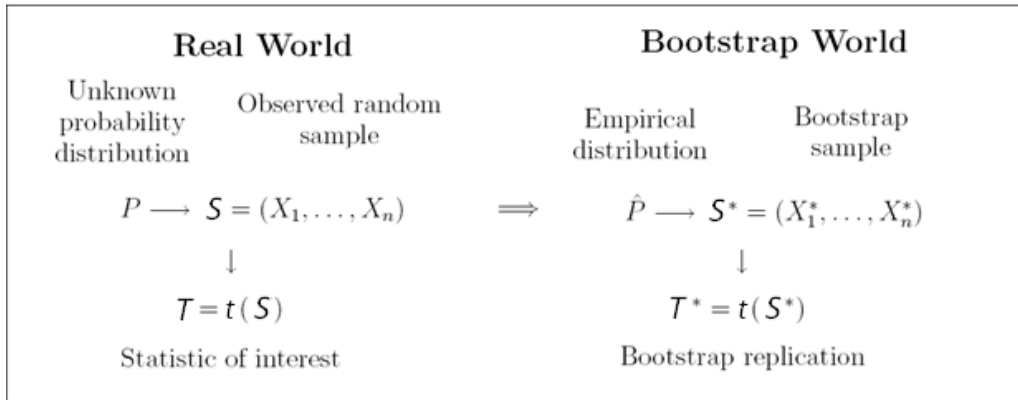

**Figure. 1: The real world and bootstrap world (Michael Echler, Handout)**

*Source: Michael Echler, Handout*

So, we will take bootstrapped samples in order to find sample distribution of required statistics  $T$ . First we would find desired statistics  $T^*$  for each bootstrapped sample:

$$T_{(b)}^* = t(S_{(b)}^*), \quad b = 1, \dots, B$$

Sample distribution  $T^*$  we would have according to empirical distribution of statistics, obtained in samples of each bootstrap repetition. Now we could take into consideration all values that  $T^*$  takes through different bootstrap repetitions. Sample distribution of statistics  $T$  which we looked for at first, is estimated through sample distribution of bootstrap statistics  $T^*$ .

We would now look at one example how creation of bootstrapped samples and manipulation with new data looks like in practice.

### Determination of standard error

One of the most important tasks of bootstrap is to describe standard error and bias of statistics followed. For estimation of standard error is used standard deviation of statistics, and before that we could calculate variance (Ibid, Eichler).

$$V^*(T^*) = \frac{1}{B-1} \sum_{b=1}^B (T_{(b)}^* - T_{(.)}^*)^2$$

Where with  $T^*(.)$  we marked arithmetical mean of values that statistics  $T^*$  takes in bootstrapped samples. Simply we calculate it:

$$T_{(.)}^* = \frac{1}{B} \sum_{b=1}^B T_{(b)}^*$$

Now that we have variance we could easily find standard deviation which is often used for describing standard error of statistics  $T^*$  in bootstrapped samples.

$$se_{boot}(T^*) = \left[ \frac{1}{B-1} \sum_{b=1}^B (T_{(b)}^* - T_{(.)}^*)^2 \right]^{\frac{1}{2}}$$

As we have approximated earlier sample distribution of statistics  $T$  with statistics  $T^*$  from bootstrapped samples, for approximation of standard error of statistics  $T$   $se_{boot}(T)$  we could use standard error of statistics  $T^*$  from bootstrapped samples,  $se_{boot}(T^*)$ .

### Estimation of bias

We estimate some unknown parameter of population  $\Theta = t(P)$  through statistics  $T$ ,  $T = t(S)$ . Bias of  $T$  statistics as an estimation for parameter  $\Theta$  is defined as

$$Bias(T) = E(T) - \theta$$



where with bias we define partiality, and define it as deviation of expected value of statistics from value of estimated parameter. If we replace unknown population  $P$  with empirical distribution  $\hat{P}$  calculated on the basis of sample, and enter the world of bootstrap, we would come to bootstrap estimation for bias:

$$Bias(T^*) = E(T^*) - \theta^*$$

Where is  $\Theta^* = t(\hat{P})$ . Although we have said that relation between population and sample in the real world is equivalent to relation between sample and bootstrap sample in bootstrap world,  $\Theta^*$  and  $T$  should not always be equal. It specifically depends on the type of unknown parameter of population that is the subject of estimation.

Once calculated bias on the level of bootstrap sample can be used for correction of  $T$  statistics and getting unbiased version. It can be achieved by:

$$T^{BC} = E(T) - bias(T^*) = 2E(T) - E(T^*)$$

Where  $T^{BC}$  is the value of statistics  $T$  corrected by bias. (Steck, Jaakkola, [http://books.nips.cc/papers/files/nips16/NIPS2003\\_AA66.pdf](http://books.nips.cc/papers/files/nips16/NIPS2003_AA66.pdf)).

Selection of samples that are incorporated in number of  $B$  repetitions at bootstrap is random. In theory we could derive all possible bootstrapped samples of size  $n$ . Then we could calculate  $E^*(T^*)$  and  $V^*(T^*)$  correctly, and not to be estimated. But, the number of samples would then be astronomically large, except in case that  $n$  is small number.

Therefore, there are two sources of errors in bootstrap inference: error due to the fact that concrete sample  $S$  represents population, and error due to smaller number of bootstrapped samples representing population than theoretically possible. This another error can be controlled by setting the number of bootstrapping  $B$  high enough.

### Bootstrap confidence interval

When performing bootstrap replications, we have estimation of sample distribution for the statistics  $T$ . Now we can use it for confidence interval of unknown parameter of population  $\Theta$ . There are several ways to construct confidence interval in bootstrap world. The simplest is so called interval of normal theory, which suppose that statistics  $T$  has normal distribution (approximately the case with samples that are big enough). Interval with  $1-\alpha$  level of confidence would be:

$$T - z_{\alpha/2} se_{boot}(T^*) < \theta < T + z_{\alpha/2} se_{boot}(T^*)$$

Where  $se_{boot}(T^*)$  is bootstrap estimation of standard error of parameter  $T$ , and  $z_{\alpha/2}$  value of  $z$ -test for corresponding value of  $\alpha$ . Because  $z$  test is applied only theoretically, the first variation is confidence interval based on Student  $t$  distribution, so called *bootstrap t interval*.

The next group is so called *percent bootstrap confidence interval*. It is functioning in the following way. First, the values of statistics from bootstrap samples,  $T^*_{(b)}$  are lined up from least to the biggest, and we have a series of  $T^*_{(1)}, T^*_{(2)}, \dots, T^*_{(B)}$  in order of increasing value. Then we introduce confidence interval limits: (Fox, 2002.):

$$\hat{T}^*_{(lower)} < \theta < \hat{T}^*_{(upper)}$$

Where lower and upper limit of confidence interval are obtained from defined series of bootstrap statistics values. These limits are calculated as follows:

$$lower = [(B + 1)a/2]; \quad upper = [(B + 1)(1 - \alpha/2)]$$

Where is B the number of bootstrap iterations, and  $\alpha$  level of significance. Medium parenthesis [] denote that the value is rounded to the closest whole number. If for example B = 999, and the level of significance 5%, lower limit is 25, and upper 975. The real value of parameter lies between 25. and 975. value of bootstrap statistics aligned by size in ascending order.

Although all these confidence intervals are popular, because for them it is not necessary to suppose normal distribution, they are not shown always good. That is why is often used so called *bias-corrected, accelerated percentile bootstrap confidence interval* marked with BC<sub>a</sub>. We will find at first «correction factor» z.

$$z = \Phi^{-1} \left[ \frac{\#_{b=1...B}(T_b^* \leq T)}{B + 1} \right]$$

Where is # ( $T_{(b)}^* \leq T$ ) proportion of bootstrap repetitions that are on or under the value of original sample estimation T. With  $\Phi^{-1}$  we have marked the cumulative distribution function. If this proportion is close to 0,5 that is if the distribution of bootstrap values is symmetrical, and T unbiased this «corrective factor» would be close to zero. Now we will introduce new «corrective factor» and mark it with a. For this corrective factor we above all would need jackknife technique (Fox, 2002.).

$$a = \frac{\sum_{i=1}^n (T_{(-i)} - \bar{T})^3}{6 [\sum_{i=1}^n (T_{(-i)} - \bar{T}^2)]^{\frac{3}{2}}}$$

Here is the value of  $T_{(-i)}$  value that parameter T obtains when from the population is extracted one of observations. It is so called jackknife value T. Because there are in total n observations this procedure can be repeated n times.  $\bar{T}$  overlined is the mean of all  $T_{(-i)}$  repetitions. The calculation continues further, according to previously calculated values, also are calculated  $a_1$  and  $a_2$  that are used for definition of interval borders:

$$a_1 = \Phi \left[ z + \frac{z - z_{1-\alpha/2}}{1 - a(z - z_{1-\alpha/2})} \right]$$

$$a_2 = \Phi \left[ z + \frac{z + z_{1-\alpha/2}}{1 - a(z + z_{1-\alpha/2})} \right]$$

Where is  $\Phi$  standard normal cumulative function. Here with the assistance of  $a_1$  and  $a_2$  values further continues like in case of percentage bootstrap interval:

$$\hat{T}_{(lower)}^* < \theta < \hat{T}_{(upper)}^*$$

Where limits are lower =  $Ba_1$ , i upper =  $Ba_2$ . In case that both corrective factors are zero,

$$a_1 = \Phi(-z_{1-\alpha/2}) = \Phi(z_{\alpha/2}) = \alpha/2; a_2 = \Phi(z_{1-\alpha/2}) = 1 - \alpha/2$$

which corresponds to uncorrected percentage bootstrap interval (in this case only it is not expressed in percentages, but in absolute numbers).

There is also next step in correction confidence intervals, that except to the already seen corrections for bias introduces also one more kind of correction, «the coefficient of nonlinearity»  $C_q$ . This new interval is marked with ABC, and as Efron himself says, it is step back comparing to complexity, because instead of deeper algorithms that are solved by computer, represents return back to the the world of formulas that are solved «by hand».

«Standard intervals depend on estimations of two parameters,  $\mu$  and  $\sigma$ . Also, ABC demands estimation of three another parameters, „acceleration”  $a$ , „bias correction”  $z_0$  i „the coefficient of nonlinearity”  $c_q$ . [ ... ]. Each of these three parameters correct deficiency of first level of standard intervals and at the end results in second-order accuracy. Of particular theoretical interest is that accuracy intervals of second order demand exactly five parameters. An important question, for which I believe that was not responded, is how many parameters are necessary for third order accuracy. The response to this question could also relate bootstrap theory with intervals based upon probability developed by Barndorff-Neilsen, Cox, Reid and others; see Reid (1995).

Last several decades of statistical research can be summarized broadly as an enormous contribution to classical theory through the strength of electronic calculations. We will continue on ABC method because it represents reverse process: return from computer algorithms to classical world of formulas. „Something was gained during this reverse journey.” (Efron, 2003.)

### Bootstrap hypothesis testing

Situation in hypothesis testing in bootstrap environment we will explain on one example. Suppose we have two populations, P and Q, out of which we have extracted one sample per each, for example X from population P and Y from population Q. Suppose that we wish to test equality of arithmetical means of these populations, through equality of populations' means. We will introduce some statistics T, which we will compare to theoretical value of t-test, in order to decide whether we could reject  $H_0$ . So,

$$H_0: P = Q; \text{ or } H_1: P \neq Q$$

That statistics will be difference between means of two populations. That statistics we will compare to critical t-test value, on the level of importance  $\alpha$ . The condition to reject  $H_0$  is:

$$P(T \geq t) \leq \alpha$$

Where P stands for probability. Because often sample distribution of population averages are not known to us, we would use bootstrap replicas of these samples. So,

$$P(T \geq t) = P^*(T^* \geq t)$$

One of problems that appear here is the fact that selection of bootstrapped samples must be performed according to null hypothesis (like population averages are equal). (Ibid, Eichler) Because this isn't the case, small correction must be performed, or populations X and Y should merge into one,

where latter in bootstrap repetitions would be taken  $n_x$  in one, or  $n_y$  observations in another bootstrap sample. When these technical problems are overcome, we calculate  $T^*$  statistics for each bootstrap repetition. And at the end it will be  $B$  (where  $B$  is veru lbig number). At the end is calculated p-value:

$$\text{p-value} = (\text{number of times when } T^*(b) > t) / B$$

We would further perform transformation:

$$\tilde{X} = X_i - \bar{X} + \bar{Z}$$

$$\tilde{Y} = Y_i - \bar{Y} + \bar{Z}$$

Where:

$$\bar{Z} = \frac{1}{n_x + n_y} \left[ \sum_{i=1}^{n_x} X_i + \sum_{i=1}^{n_y} Y_i \right]$$

All values in both samples will be corrected for atithmetical mean of joined sample. Bootstrap repetitions will be now conducted from these corrected populations  $X$  and  $Y$ . Then is calculated critical statistics  $T^*$  for each bootstrap repetition from 1 to  $B$ :

$$T^{*(b)} = \frac{X^{*(b)} - Y^{*(b)}}{\sqrt{\left( \frac{S^2_{X^{*(b)}}}{n_x} + \frac{S^2_{Y^{*(b)}}}{n_y} \right)}}$$

As a difference between each bootstrap repetition of two samples. Calculated statistics  $T^*$  is then compared to  $t$  value of the test.

### **An insurance industry example**

We now arrive to the example of practical use of bootstrap methodology. We shall see in a short insurance industry example how resampling can be used for constructing confidence intervals and hypothesis testing. The example is made on real data, collected through last business year in insurance company Takovo Osiguranje, leading insurance entity in central Serbia.

From the Book of Damages for business year 2011 we extracted some data that can be interesting in demonstrating the power of bootstrap methodology. Data we obtained concern a special category of damages – damages originated by accidents, on persons, that are liquidated in the current business year, with payment. So, we neglect accidents that are reserved for the next year, or that draw no payment at liquidation, for the amount of money for those is 0. We want to see how variable the payment at liquidation for this kind of accidents can be. We add another simple assumption, that these accidents were reported as ‘big damages’ (for they were asking payment over 500 euro in dinar equivalent). We shall see that not all of them resulted in payment these high, or higher.

After drawing these assumptions we came out with 6 different results, as we can see on Table 1. The data shows amounts paid for damages in Serbian dinars. The seventh data contains 0 elements, as it is data with damage that appeared on object, not on person, so we shall neglect it for now.

**Table 1: Data from the original report**

10,631.00		758,222.00		769,853.00		0.00		0.00		0.00	
Liquidated amount of damage in the period between 01.01.2011. - 31.12.2011.			Total			Reserved amount of damage on 31.12.2011.					
On the property		On the persons				On the property		On the persons		Total	
22		23		24		37		38		39	
0.00		50,000.00		50,000.00				0.00		0.00	
0.00		1,500.00		1,500.00				0.00		0.00	
0.00		42,750.00		42,750.00				0.00		0.00	
0.00		400,000.00		400,000.00				0.00		0.00	
0.00		20,000.00		20,000.00				0.00		0.00	
10,631.00		0.00		10,631.00		0.00				0.00	
0.00		243,972.00		243,972.00				0.00		0.00	

We now open new worksheet for bootstrapping operations. As bootstrap software we will use The Microsoft Excel add-in, Resampling Stats for Excel 2007. The add-in is Excel based, and very simple for use, can be downloaded for trial period. We will also explain each step.

First we copy the data into the new worksheet, and calculate mean, and standard deviation. This can be easily done using Excel formula. Short view gives us an insight in the problem – the data is highly variable, it goes from 1500 to 400 000 dinars. The average ‘big’ damage is 126 370.33 dinars, which doesn’t tell us too much. Situation is even worse with standard deviation, as it is 160 271.88 dinars. If we want to build confidence interval for the mean of big damages, it would go from lower - 41 852.05 to upper 294 592.72. Too bad, payments doesn’t go in minus. We shall see if the bootstrapping can make some improvements.

On Table 2 we can see the results we obtained so far, but also introduction of bootstrap procedure. To the right we can see the column named “Resample 1”, the first of the bootstrap replication of our original sample. As we elaborated, resampling is done with replication, making the bootstrapped samples the same size as the original one. This resample is obtained by clicking the right mouse button and choosing the new ‘Resampling’ option, brought by this add-in. Using the same methodology we obtain the mean of first resample.

After this step it takes more computer work to complete bootstrapping procedure. The next thing to do is to repeat previous steps, i.e. taking new bootstrapped samples, and finding their mean let’s say, a thousand times. With computer support, this takes approximately 5 second. We click right button the cell with the mean of the first resample, in our case it is F10, and in Resampling menu chose Repeat and Score option. Then we chose the number of repeating, let’s say a 1000, and after a few seconds, we get completely new worksheet, with 1000 means of 1000 bootstrapped samples sorted in one column. We don’t really see the structure of all 1000 samples, but we get 1000 means that are important to us. We now switch in new environment.

From the beginning we can sort those means in ascending order – we are going to need this! Then we calculate the mean of all means, and standard deviation of means. The mean is close, but different from the mean calculated at original data – 124 202.88, slightly higher number. Standard deviation is the field that bootstrapping makes much of improvement – it is now more than two and a half times lower – 60 163.89. This will provide us a confidence interval closer to reality. We now have all the elements for constructing various possible intervals within bootstrap environment.

Table 2: Sample, CI and first resample

	A	B	C	D	E	F	G	H
1	Original data					Resample 1		
2	50000.00		Interval lower	Interval upper		50000.00		
3	1500.00		-41852.05	294592.72		42750.00		
4	42750.00					42750.00		
5	400000.00					400000.00		
6	20000.00					42750.00		
7	243972.00					20000.00		
8								
9	Mean					Rsmpl mean		
10	126370.33					99708.33		
11	St Dev							
12	160271.88							
13								
14								
15								

Let’s start with classical confidence interval applied to bootstrap environment. These confidence intervals assume that the real world data are normally-distributed (or invoke laws that state that nonnormally-distributed data can be used if the sample size is large enough). In our case, sample size is large enough, but data is probably not normally distributed. If we make confidence interval using the formula we mentioned before

$$T - z_{\alpha/2} se_{boot}(T^*) < \theta < T + z_{\alpha/2} se_{boot}(T^*)$$

With the value of t statistics close enough to  $Z_{\alpha/2}$  for large sample, confidence interval would go from 6 281.85 as lower limit to 242 124.1 as upper limit. This confidence interval is symmetric, putting mean of all means in the center. But the distribution of bootstrap samples means is clearly biased – there are no means lower than the lower limit, (can be seen at Table 3) but there are 38 means higher than the upper limit! This confidence interval is clearly not god for approximating the distribution.

The second type of confidence interval is so percentile confidence interval. It is both easy to achieve and to explain, but also doesn’t require data that are normally-distributed.

$$T^*_{(lower)} < \theta < T^*_{(upper)}$$

$$lower = [(B + 1)\alpha/2]; upper = [(B + 1)(1 - \alpha/2)]$$

If  $\alpha=0.05$ , than the confidence interval is obtained once we cut off lowest 25 and highest 25 values of bootstrapped samples means (because in our case, B=1000). In the Table 3, 25th percentile can be seen, but also to the right can be seen the entire interval – it goes from 23 833.33 to 252 328.67, and shows clearly that it is not symmetrical around the mean of all means. It has significant departure from the lower limit comparing to standard CI applied to this bootstrap case.

In the end, we calculate so called bias-corrected and accelerated CI. Resampling for Excel offers special computing operation for this CI, where all you need is to highlight the data you are building CI for (original sample, not a single resample is needed), and to highlight the mean. It automatically offers you 1000 replications at significance level of 0.95. If you don’t change these

parameters, it will produce result within 10 seconds, marking lower and upper limit. In our case (Table 3 once again), it has even bigger departure from the lower limit of standard CI, but much bigger departure at upper limit, than percentile CI.

In many cases it is useful to calculate both BCA and percentile CI, and to compare obtained results.

### Hypothesis testing

We will test hypothesis that the mean of this group of damages is not significantly different from the mean of one bigger group, so called 10<sup>th</sup> category, which comprises damages insured by obligatory motor vehicles insurance. We also take only damages made on persons, with assumptions that those were reported as ‘big’ damages. This group has 1736 observations, with average result at 179 664.67.

**Table 3: Sampling distribution of bootstrapped means on the left, comparison of CI to the right**

	A	B	C	D	E	F	G	H
1	Rsmpl means							
2	9583.33	Mean of means			Interval lowe	Interval upper		
3	13833.33	124202.88			-41825.05	294952.72		
4	15750.00	St Dev						
5	15750.00	60163.89			boot t lower	boot t upper		
6	16458.33				6281.65	242124.10		
7	17625.00							
8	17625.00				pctl lower	pctl upper		
9	17625.00				23833.33	252328.67		
10	17666.67							
11	17666.67				BCA LCL	BCA UCL		
12	17666.67				31892.12	287448.67		
13	18833.33							
14	19541.67							
15	19541.67							
16	19541.67							
17	20750.00							
18	20750.00							
19	21416.67							
20	21416.67							
21	21416.67							
22	21916.67							
23	22125.00							
24	22625.00							
25	23333.33							
26	23833.33							
27	23833.33							

We create zero hypothesis that mean of the first population is not significantly different from the mean of the second. Alternative hypothesis is they are different ([http://faculty.psy.ohio-state.edu/myung/personal/course/826/bootstrap\\_hypo.pdf](http://faculty.psy.ohio-state.edu/myung/personal/course/826/bootstrap_hypo.pdf)).

$$H_0: \mu_x = \mu_y ; \text{ or } H_1: \mu_x \neq \mu_y$$

We first compute difference between two means. It is 53 294.34, and let's denote it by  $t_{obs}$ . Now we merge two samples into one, and take the option Shuffle from our Resampling options. Once we choose area for reshuffling, we get new mutual sample created by sampling without repeating. As in the mutual sample first  $n_y$  observations were from the 10<sup>th</sup> category (second sample), in the shuffled sample also first  $n_y$  observations will go into this sample. Now we compute means for new samples, compute their difference, and by choosing option Repeat and Score, we let computer do shuffling and computing for the next 1000 times. After approximately 30 seconds, we have the new worksheet with 1000 differences between two mean.

We shall find p-value as the number of times  $T^*$  is higher than  $t_{obs}$ , divided by 1000 (for there are a 1000 replications). If the p-value is higher than 0.05 we shall retain null hypothesis, otherwise, there we shall reject it.

We now compare those 1000 means with difference in mean between two original samples. We can use function COUNTIF from Excel, to find number of times  $T^*$  is bigger than  $t_{obs}$ . The result is 399, so p-value is 0.39. It is much higher than 0.05, so there is no proof that those means are significantly different, thus we retain zero hypothesis.

**Table 4: Differences between two means, and number of differences higher than 53 294.64**

	A	B	C
1	Differences	No diffnc => 53 294.64	
2	2946.092619	399.00	
3	-47181.39567		
4	-8494.144516		
5	-343760.381		
6	98158.3672		
7	87531.26409		
8	93005.11777		
9	96312.84396		
10	50172.42173		
11	62197.33935		
12	69128.37872		
13	-273042.3323		
14	17193.49853		
15	-79754.48437		
16	78752.36009		

**Instead of conclusion**

Statistical methods based on resampling as non parametric methods induced the biggest progress in statistics in the second half of XX century and provided revolutionary contribution both to statistical theory and practice. Most important among these methods are bootstrap and permutaton tests.



Application of bootstrap methods in the example with insurance company demonstrated how the confidence interval should be reduced in order to contain meaningful figures. We must bear in mind that neither too small nor too big confidence interval provides drawing relevant conclusions regarding the population parameters, statistics, and hypothesis testing.

The example contains 1000 resamples (in practice it is proposed to have at least 200, preferably more resamples, and the figure of 1000 is the most favourable option). Values for mean and standard deviation were corrected in resampling procedure, and they reflect more – the increase in number of samples increases precision in obtained estimations.

Simplicity of procedure is based on the use of easily accessible software, and proper entrance of data that itself generates distribution – bootstrap distribution. Example demonstrates the most important advantages of the bootstrap method – independence from type of distribution, wider applicability - outside of the existing tables and formulas and precision in conclusions.

### References

- Beran, Rudolf J. "Bootstrap Asymptotics" (version 2). *StatProb: The Encyclopedia Sponsored by Statistics and Probability Societies*. Freely available at <http://statprob.com/encyclopedia/ResamplingAsymptotics.html>
- Chernick, Michael R. (2010) "Bootstrap Methods." In: Lovric, Miodrag (Editor), *International Encyclopedia of Statistical Science*. Heidelberg: Springer Science +Business Media, LLC, reprinted and freely available at StatProb: The Encyclopedia Sponsored by Statistics and Probability Societies.
- DiCiccio, T.J., Efron, B. (1995) *Bootstrap confidence intervals*, Technical Report No 175, online available at <http://statistics.stanford.edu/~ckirby/techreports/BIO/BIO%20175.pdf>
- Efron, B. (1979) *Bootstrap methods – Another look at Jackknife*, The Annals of Statistics, 7 (1)
- Efron, B. (2003) *Second thoughts on Bootstrap*, Statistical Science 18 (2) p. 135, 138
- Eichler, M. *Introduction to the Bootstrap*, University of Chicago, online available at <http://galton.uchicago.edu/~eichler/stat24600/Handouts/bootstrap.pdf>
- Fox, J. (2002) *Bootstrapping Regression Models, Appendix to applied regression*, McMaster University, online available at <http://cran.r-project.org/doc/contrib/Fox-Companion/appendix-bootstrapping.pdf>
- Steck, H., Jaakkola, T. *Bias-Corrected Bootstrap and Uncertainty Model*, MIT, online available at [http://books.nips.cc/papers/files/nips16/NIPS2003\\_AA66.pdf](http://books.nips.cc/papers/files/nips16/NIPS2003_AA66.pdf)
- [http://faculty.psy.ohio-state.edu/myung/personal/course/826/bootstrap\\_hypo.pdf](http://faculty.psy.ohio-state.edu/myung/personal/course/826/bootstrap_hypo.pdf) (January, 28, 2012.)
- [www.resampling.com](http://www.resampling.com) (January, 28, 2012.)

